

Entirely up-to-date  
with BS 7671:2008

BRIAN SCADDAN

EDITION  
**17**  
**IEE**  
**WIRING**  
**REGULATIONS**

For C&G  
2382-10 &  
2382-20

# Explained AND Illustrated



**EIGHTH  
EDITION**



**17th Edition**  
**IEE Wiring Regulations:**  
**Explained and Illustrated**

*By the same author*

17th Edition IEE Wiring Regulations: Design and Verification of Electrical Installations, ISBN 978-0-7506-8721-8

17th Edition IEE Wiring Regulations: Inspection, Testing and Certification, ISBN 978-0-7506-8719-5

Electric Wiring: Domestic, ISBN 978-0-7506-8735-5

PAT: Portable Appliance Testing, ISBN 978-0-7506-8736-2

Wiring Systems and Fault Finding, ISBN 978-0-7506-8734-8

Electrical Installation Work, ISBN 978-0-7506-8733-1

# 17th Edition

## IEE Wiring Regulations: Explained and Illustrated

Eighth edition

Brian Scaddan IEng, MIET



AMSTERDAM • BOSTON • HEIDELBERG • LONDON  
NEW YORK • OXFORD • PARIS • SAN DIEGO  
SAN FRANCISCO • SINGAPORE • SYDNEY • TOKYO  
Newnes is an imprint of Elsevier



Newnes is an imprint of Elsevier  
Linacre House, Jordan Hill, Oxford OX2 8DP, UK  
30 Corporate Drive, Suite 400, Burlington, MA 01803, USA

First published 1989

Second edition 1991

Third edition 1996

Fourth edition 1998

Fifth edition 2001

Sixth edition 2002

Reprinted 2002, 2003, 2004

Seventh edition 2005

Eighth edition 2008

Copyright © 2008, Brian Scaddan. Published by Elsevier Ltd. All rights reserved

The right of Brian Scaddan to be identified as the author of this work has been asserted in accordance with the Copyright, Designs and Patents Act 1988

No part of this publication may be reproduced, stored in a retrieval system or transmitted in any form or by any means electronic, mechanical, photocopying, recording or otherwise without the prior written permission of the publisher

Permissions may be sought directly from Elsevier's Science & Technology Rights Department in Oxford, UK: phone (+44) (0) 1865 843830; fax (+44) (0) 1865 853333; email: [permissions@elsevier.com](mailto:permissions@elsevier.com). Alternatively you can submit your request online by visiting the Elsevier website at <http://elsevier.com/locate/permissions>, and selecting *Obtaining permission to use Elsevier material*

Notice

No responsibility is assumed by the publisher for any injury and/or damage to persons or property as a matter of products liability, negligence or otherwise, or from any use or operation of any methods, products, instructions or ideas contained in the material herein

#### **British Library Cataloguing in Publication Data**

Scaddan, Brian

17th edition IEE wiring regulations : explained and illustrated. – 8th ed.

1. Electric wiring, Interior – Safety regulations – Great Britain 2. Electric wiring, Interior – Handbooks, manuals, etc.

I. Title II. Scaddan, Brian. 16th edition IEE wiring regulations III. Institution of Electrical Engineers IV. Seventeenth edition IEE wiring regulations  
621.3'1924'0941

**Library of Congress Control Number:** 2008927641

ISBN: 978-0-7506-8720-1

For information on all Newnes publications  
visit our website at [www.elsevierdirect.com](http://www.elsevierdirect.com)

Typeset by Charon Tec Ltd., A Macmillan Company. ([www.macmillansolutions.com](http://www.macmillansolutions.com))

Printed and bound in Slovenia

08 09 10 11 11 10 9 8 7 6 5 4 3 2 1

Working together to grow  
libraries in developing countries

[www.elsevier.com](http://www.elsevier.com) | [www.bookaid.org](http://www.bookaid.org) | [www.sabre.org](http://www.sabre.org)

ELSEVIER

BOOK AID  
International

Sabre Foundation

# Contents

PREFACE.....	vii
INTRODUCTION.....	ix
<b>CHAPTER 1 Fundamental Requirements for Safety</b> .....	1
IEE Wiring Regulations (IEE Regulations Part 1 and Chapter 13).....	1
The Health and Safety at Work Act 1974.....	3
The Electricity at Work Regulations 1989.....	5
An Extract from the Building Regulations Approved Document ‘P’.....	9
<b>CHAPTER 2 Earthing</b> .....	17
Definitions Used in this Chapter.....	17
Earth: What It Is, and Why and How We Connect to It.....	19
Earth Electrode Resistance.....	23
Earthing in the IEE Regulations (IEE Regulations Chapter 4, Section 411).....	25
Earthing Systems (IEE Regulations Definitions (Systems)).....	28
Earth Fault Loop Impedance.....	30
Determining the Value of Total Loop Impedance.....	32
Additional Protection.....	38
<b>CHAPTER 3 Protection</b> .....	45
Definitions Used in this Chapter.....	45
What Is Protection?.....	47
Protection Against Electric Shock (IEE Regulations Chapter 41).....	54
Protection Against Overcurrent (IEE Regulations Chapter 43 and Definitions).....	59
Protection Against Overvoltage (IEE Regulations Section 443).....	69
Protection Against Undervoltage (IEE Regulations Section 445).....	69
<b>CHAPTER 4 Isolation Switching and Control</b> .....	71
Definitions Used in this Chapter.....	71
Isolation and Switching (IEE Regulations Section 537).....	71

<b>CHAPTER 5</b> Circuit Design.....	73
Definitions Used in this Chapter.....	73
Design Procedure.....	74
Design Current.....	75
Nominal Setting of Protection.....	76
Voltage Drop (IEE Regulations 525 and Appendix 12).....	82
Shock Risk (IEE Regulations Section 411).....	83
Thermal Constraints (IEE Regulations Section 543).....	84
Example of Use of the Adiabatic Equation.....	87
An Example of Circuit Design.....	89
Assessment of General Characteristics.....	95
Sizing the Main Tails.....	95
Sizing the Kiln Circuit Cable.....	96
<b>CHAPTER 6</b> Inspection and Testing.....	99
Definitions Used in this Chapter.....	99
Testing Sequence (Part 7).....	99
<b>CHAPTER 7</b> Special Locations IEE Regulations Part 7.....	117
Introduction.....	117
BS 7671 Section 701: Bathrooms, etc.....	118
BS 7671 Section 702: Swimming Pools.....	122
BS 7671 Section 703: Hot Air Saunas.....	124
BS 7671 Section 704: Construction Sites.....	125
BS 7671 Section 705: Agricultural and Horticultural Locations.....	127
BS 7671 Section 706: Restrictive Conductive Locations.....	129
BS 7671 Section 708: Caravan and Camping Parks.....	130
BS 7671 Section 709: Marinas.....	131
BS 7671 Section 711: Exhibitions, Shows and Stands.....	132
BS 7671 Section 712: Solar Photovoltaic (PV) Supply Systems.....	133
BS 7671 Section 717: Mobile or Transportable Units.....	134
BS 7671 Section 721: Caravans and Motor Caravans.....	134
BS 7671 Section 740: Amusement Devices, Fairgrounds, Circuses, etc.....	136
BS 7671 Section 753: Floor and Ceiling Heating Systems.....	137
<b>APPENDIX 1:</b> Problems.....	139
<b>APPENDIX 2:</b> Answers to Problems.....	141
INDEX.....	143

# Preface

As a result of many years developing and teaching courses devoted to compliance with the IEE Wiring Regulations, it has become apparent to me that many operatives and personnel in the electrical contracting industry have forgotten the basic principles and concepts upon which electric power supply and its use are based. As a result of this, misconceived ideas and much confusion have arisen over the interpretation of the Regulations.

It is the intention of this book to dispel such misconceptions and to educate and where necessary refresh the memory of the reader. In this respect, emphasis has been placed on those areas where most confusion arises, namely earthing and bonding, protection, and circuit design.

The current seventeenth edition of the IEE Wiring Regulations, also known as BS 7671, to which this book conforms, was published in January 2008. This book is *not* a guide to the Regulations or a replacement for them; nor does it seek to interpret them Regulation by Regulation. It should, in fact, be read in conjunction with them; to help the reader, each chapter cites the relevant Regulation numbers for cross-reference.

It is hoped that the book will be found particularly useful by college students, electricians and technicians, and also by managers of smaller electrical contracting firms that do not normally employ engineers or designers. It should also be a useful addition to the library of those studying for the C&G 2382 series qualifications.

*Brian Scaddan, April 2008*

Material on Part P in Chapter 1 is taken from *Building Regulations Approved Document P: Electrical Safety – Dwellings*, P1 Design and installation of electrical installations (The Stationery Office, 2006) ISBN 9780117036536. © Crown copyright material is reproduced with the permission of the Controller of HMSO and Queen's Printer for Scotland.

## Acknowledgements

I would like to thank Paul Clifford for his thorough technical proof reading.

# Introduction

It was once said, by whom I have no idea, that ‘rules and regulations are for the guidance of wise men and the blind obedience of fools’. This is certainly true in the case of the IEE Wiring (BS 7671) Regulations. They are not statutory rules, but recommendations for the safe selection and erection of wiring installations. Earlier editions were treated as an ‘electrician’s Bible’: the Regulations now take the form primarily of a design document.

The IEE Wiring Regulations are divided into seven parts. These follow a logical pattern from the basic requirements to inspection and testing of an installation and finally to the requirements for special locations:

*Part 1* indicates the range and type of installations covered by the Regulations, what they are intended for, and the basic requirements for safety.

*Part 2* is devoted to the definitions of the terms used throughout the Regulations.

*Part 3* details the general information needed and the fundamental principles to be adopted before any design work can usefully proceed.

*Part 4* informs the designer of the different methods available for protection against electric shock, overcurrent, etc., and how to apply those methods.

*Part 5* enables the correct type of equipment, cable, accessory, etc. to be selected and erected in accordance with the requirements of Parts 1–4.

*Part 6* provides details of the relevant tests to be performed on a completed installation before it is energized.

*Part 7* deals with particular requirements for special installations and locations such as bathrooms, swimming pools, construction sites, etc.

*Appendices 1–15* provide tabulated and other background information required by the designer/installer/tester.

It must be remembered that the Regulations are not a collection of unrelated statements each to be interpreted in isolation; there are many cross-references throughout which may render such an interpretation valueless.

In using the Regulations I have found the index an invaluable starting place when seeking information. However, one may have to try different combinations of wording in order to locate a particular item. For example, determining how often an RCD should be tested via its test button could prove difficult since no reference is made under 'Residual current devices' or 'Testing'; however, 'Periodic testing' leads to Regulation 514.12, and the information in question is found in 514.12.2. In the index, this Regulation is referred under 'Notices'.

# Fundamental Requirements for Safety

## IEE WIRING REGULATIONS (IEE REGULATIONS PART 1 AND CHAPTER 13)

It does not require a degree in electrical engineering to realize that electricity at *low* voltage can, if uncontrolled, present a serious threat of injury to persons or livestock, or damage to property by fire.

Clearly the type and arrangement of the equipment used, together with the quality of workmanship provided, will go a long way to minimizing danger. The following is a list of basic requirements:

1. Use good workmanship.
2. Use approved materials and equipment.
3. Ensure that the correct type, size and current-carrying capacity of cables are chosen.
4. Ensure that equipment is suitable for the maximum power demanded of it.
5. Make sure that conductors are insulated, and sheathed or protected if necessary, or are placed in a position to prevent danger.
6. Joints and connections should be properly constructed to be mechanically and electrically sound.
7. Always provide overcurrent protection for every circuit in an installation (the protection for the whole installation is usually provided by the Distribution Network Operator

- [DNO]), and ensure that protective devices are suitably chosen for their location and the duty they have to perform.
8. Where there is a chance of metalwork becoming live owing to a fault, it should be earthed, and the circuit concerned should be protected by an overcurrent device or a residual current device (RCD).
  9. Ensure that all necessary bonding of services is carried out.
  10. Do not place a fuse, a switch or a circuit breaker, unless it is a linked switch or circuit breaker, in an earthed neutral conductor. The linked type must be arranged to break all the line conductors.
  11. All single-pole switches must be wired in the line conductor only.
  12. A readily accessible and effective means of isolation must be provided, so that all voltage may be cut off from an installation or any of its circuits.
  13. All motors must have a readily accessible means of disconnection.
  14. Ensure that any item of equipment which may normally need operating or attending by persons is accessible and easily operated.
  15. Any equipment required to be installed in a situation exposed to weather or corrosion, or in explosive or volatile environments, should be of the correct type for such adverse conditions.
  16. Before adding to or altering an installation, ensure that such work will not impair any part of the existing installation and that the existing is in a safe condition to accommodate the addition.
  17. After completion of an installation or an alteration to an installation, the work must be inspected and tested to ensure, as far as reasonably practicable, that the fundamental requirements for safety have been met.

These requirements form the basis of the IEE Regulations.

It is interesting to note that, whilst the Wiring Regulations are not statutory, they may be used to claim compliance with Statutory Regulations such as the Electricity at Work Regulations, the Health and Safety at Work Act and Part 'P' of the Building Regulations. In fact, the Health and Safety Executive produces guidance notes for installations in such places as schools and construction sites. The contents of these documents reinforce and extend the requirements of the IEE Regulations. Extracts from the Health and Safety at Work Act, the Electricity at Work Regulations and Part 'P' of the Building Regulations are reproduced below.

## THE HEALTH AND SAFETY AT WORK ACT 1974

### Duties of employers

Employers must safeguard, as far as is reasonably practicable, the health, safety and welfare of all the people who work for them. This applies in particular to the provision and maintenance of safe plant and systems of work, and covers all machinery, equipment and appliances used.

Some examples of the matters which many employers need to consider are:

1. Is all plant up to the necessary standards with respect to safety and risk to health?
2. When new plant is installed, is latest good practice taken into account?
3. Are systems of work safe? Thorough checks of all operations, especially those operations carried out infrequently, will ensure that danger of injury or to health is minimized. This may require special safety systems, such as 'permits to work'.

4. Is the work environment regularly monitored to ensure that, where known toxic contaminants are present, protection conforms to current hygiene standards?
5. Is monitoring also carried out to check the adequacy of control measures?
6. Is safety equipment regularly inspected? All equipment and appliances for safety and health, such as personal protective equipment, dust and fume extraction, guards, safe access arrangement, monitoring and testing devices, need regular inspection (Section 2(1) and 2(2) of the Act).

No charge may be levied on any employee for anything done or provided to meet any specific requirement for health and safety at work (Section 9).

Risks to health from the use, storage, or transport of 'articles' and 'substances' must be minimized. The term *substance* is defined as 'any natural or artificial substance whether in solid or liquid form or in the form of gas or vapour' (Section 53(1)).

To meet these aims, all reasonably practicable precautions must be taken in the handling of any substance likely to cause a risk to health. Expert advice can be sought on the correct labelling of substances, and the suitability of containers and handling devices. All storage and transport arrangements should be kept under review.

### **Safety information and training**

It is now the duty of employers to provide any necessary information and training in safe practices, including information on legal requirements.

### **Duties to others**

Employers must also have regard for the health and safety of the self-employed or contractors' employees who may be working close

to their own employees, and for the health and safety of the public who may be affected by their firm's activities.

Similar responsibilities apply to self-employed persons, manufacturers and suppliers.

### **Duties of employees**

Employees have a duty under the Act to take reasonable care to avoid injury to themselves or to others by their work activities, and to cooperate with employers and others in meeting statutory requirements. The Act also requires employees not to interfere with or misuse anything provided to protect their health, safety or welfare in compliance with the Act.

## **THE ELECTRICITY AT WORK REGULATIONS 1989**

### **Persons on whom duties are imposed by these Regulations**

1. Except where otherwise expressly provided in these Regulations, it shall be the duty of every:
  - a. employer and self-employed person to comply with the provisions of these Regulations in so far as they relate to matters which are within his control; and
  - b. manager of a mine or quarry (within in either case the meaning of Section 180 of the Mines and Quarries Act 1954) to ensure that all requirements or prohibitions imposed by or under these Regulations are complied with in so far as they relate to the mine or quarry or part of a quarry of which he is the manager and to matters which are within his control.

2. It shall be the duty of every employee while at work:
  - a. to cooperate with his employer in so far as is necessary to enable any duty placed on that employer by the provisions of these Regulations to be complied with; and
  - b. to comply with the provisions of these Regulations in so far as they relate to matters which are within his control.

### Employer

1. For the purposes of the Regulations, an employer is any person or body who (a) employs one or more individuals under a contract of employment or apprenticeship; or (b) provides training under the schemes to which the HSW Act applies through the Health and Safety (Training for Employment) Regulations 1988 (Statutory Instrument No. 1988/1222).

### Self-employed

2. A self-employed person is an individual who works for gain or reward otherwise than under a contract of employment whether or not he employs others.

### Employee

3. Regulation 3(2)(a) reiterates the duty placed on employees by Section 7(b) of the HSW Act.
4. Regulation 3(2)(b) places duties on employees equivalent to those placed on employers and self-employed persons where these are matters within their control. This will include those trainees who will be considered as employees under the Regulations described in paragraph 1.

5. This arrangement recognizes the level of responsibility which many employees in the electrical trades and professions are expected to take on as part of their job. The 'control' which they exercise over the electrical safety in any particular circumstances will determine to what extent they hold responsibilities under the Regulations to ensure that the Regulations are complied with.
6. A person may find himself responsible for causing danger to arise elsewhere in an electrical system, at a point beyond his own installation. This situation may arise, for example, due to unauthorized or unscheduled back feeding from his installation onto the system, or to raising the fault power level on the system above rated and agreed maximum levels due to connecting extra generation capacity, etc. Because such circumstances are 'within his control', the effect of Regulation 3 is to bring responsibilities for compliance with the rest of the regulations to that person, thus making him a duty holder.

### **Absolute/reasonably practicable**

7. Duties in some of the Regulations are subject to the qualifying term 'reasonably practicable'. Where qualifying terms are absent the requirement in the Regulation is said to be absolute. The meaning of reasonably practicable has been well established in law. The interpretations below are given only as a guide to duty holders.

### **Absolute**

8. If the requirement in a Regulation is 'absolute', for example if the requirement is not qualified by the words 'so far as is reasonably practicable', the requirement must be met

regardless of cost or any other consideration. Certain of the regulations making such absolute requirements are subject to the Defence provision of Regulation 29.

### Reasonably practicable

9. Someone who is required to do something 'so far as is reasonably practicable' must assess, on the one hand, the magnitude of the risks of a particular work activity or environment and, on the other hand, the costs in terms of the physical difficulty, time, trouble and expense which would be involved in taking steps to eliminate or minimize those risks. If, for example, the risks to health and safety of a particular work process are very low, and the cost or technical difficulties of taking certain steps to prevent those risks are very high, it might not be reasonably practicable to take those steps. The greater the degree of risk, the less weight that can be given to the cost of measures needed to prevent that risk.
10. In the context of the Regulations, where the risk is very often that of death, for example from electrocution, and where the nature of the precautions which can be taken are so often very simple and cheap, e.g. insulation, the level of duty to prevent that danger approaches that of an absolute duty.
11. The comparison does not include the financial standing of the duty holder. Furthermore, where someone is prosecuted for failing to comply with a duty 'so far as is reasonably practicable', it would be for the accused to show the court that it was not reasonably practicable for him to do more than he had in fact done to comply with the duty (Section 40 of the HSW Act).

## AN EXTRACT FROM THE BUILDING REGULATIONS APPROVED DOCUMENT 'P'

### Certification of notifiable work

#### a. Where the installer is registered with a Part P competent person self-certification scheme

**1.18** Installers registered with a Part P competent person self-certification scheme are qualified to complete BS 7671 installation certificates and should do so in respect of every job they undertake. A copy of the certificate should always be given to the person ordering the electrical installation work.

**1.19** Where Installers are registered with a Part P competent person self-certification scheme, a Building Regulations compliance certificate must be issued to the occupant either by the installer or the installer's registration body within 30 days of the work being completed. The relevant building control body should also receive a copy of the information on the certificate within 30 days.

**1.20** The Regulations call for the Building Regulations compliance certificate to be issued to the occupier. However, in the case of rented properties, the certificate may be sent to the person ordering the work with a copy sent also to the occupant.

#### b. Where the installer is *not* registered with a Part P competent person self-certification scheme but qualified to complete BS 7671 installation certificates

**1.21** Where notifiable electrical installer work is carried out by a person not registered with a Part P competent person self-certification the work should be notified to a building control body (the local authority or an approved inspector) before work starts. Where the work is necessary because of an emergency the

building control body should be notified as soon as possible. The building control body becomes responsible for making sure the work is safe and complies with all relevant requirements of the Building Regulations.

**1.22** Where installers are qualified to carry out inspection and testing and completing the appropriate BS 7671 installation certificate, they should do so. A copy of the certificate should then be given to the building control body. The building control body will take this certificate into account in deciding what further action (if any) needs to be taken to make sure that the work is safe and complies fully with all relevant requirements. Building control bodies may ask for evidence that installers are qualified in this case.

**1.23** Where the building control body decides that the work is safe and meets all building regulation requirements it will issue a building regulation completion certificate (the local authority) on request or a final certificate (an approved inspector).

### **c. Where installers are not qualified to complete BS 7671 completion certificates**

**1.24** Where such installers (who may be contractors or DIYers) carry out notifiable electrical work, the building control body must be notified before the work starts. Where the work is necessary because of an emergency the building control body should be notified as soon as possible. The building control body then becomes responsible for making sure that the work is safe and complies with all relevant requirements in the Building Regulations.

**1.25** The amount of inspection and testing needed is for the building control body to decide based on the nature and extent of the electrical work. For relatively simple notifiable jobs, such as adding a socket outlet to a kitchen circuit, the inspection and testing requirements will be minimal. For a house rewire, a full set of inspection and tests may need to be carried out.

**1.26** The building control body may choose to carry out the inspection and testing itself, or to contract out some or all of the work to a special body which will then carry out the work on its behalf. Building control bodies will carry out the necessary inspection and testing at their expense, not at the householders' expense.

**1.27** A building control body will **not** issue a BS 7671 installation certificate (as these can be issued only by those carrying out the work), but only a Building Regulations completion certificate (the local authority) or a final certificate (an approved inspector).

### **Third party certification**

**1.28** Unregistered installers should not themselves arrange for a third party to carry out final inspection and testing. The third party – not having supervised the work from the outset – would not be in a position to verify that the installation work complied fully with BS 7671:2008 requirements. An electrical installation certificate can be issued only by the installer responsible for the installation work.

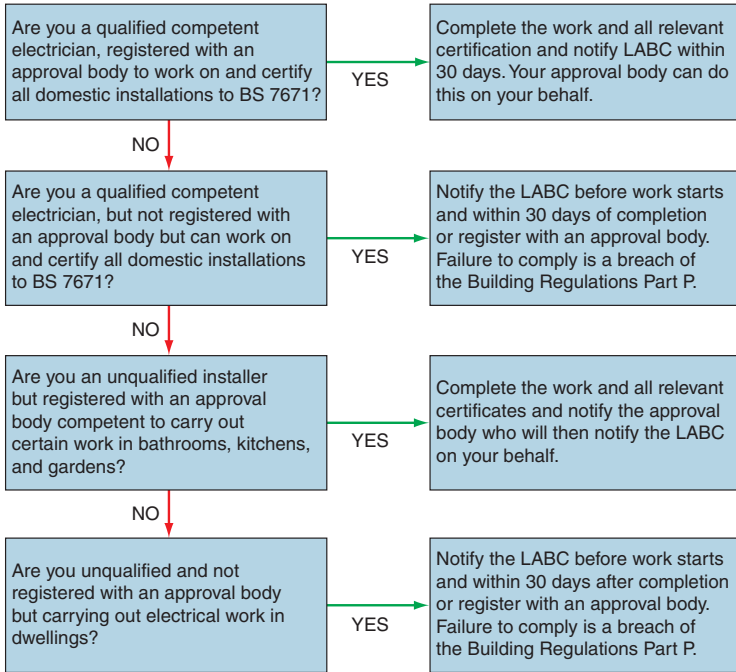
**1.29** A third party could only sign a BS 7671:2008 Periodic Inspection Report or similar. The Report would indicate that electrical safety tests had been carried out on the installation which met BS 7671:2008 criteria, but it could not verify that the installation complied fully with BS 7671:2008 requirements – for example, with regard to routing of hidden cables.

### **Part 'P'**

The following material is taken from *The Building Regulations 2000 approved document P*. © Crown copyright material is reproduced with the permission of the Controller of HMSO and Queen's Printer for Scotland.

Part 'P' of the building Regulations requires that certain electrical installation work in domestic dwellings be certified and notified to the Local Authority Building Control (LABC). Failure to provide this notification may result in substantial fines.

*Who am I and what do I do?*



**FIGURE 1.1**

Some approval bodies offer registration for all electrical work in domestic premises; these are known as full scope schemes (FS). Other bodies offer registration for certain limited work in special locations such as kitchens, bathrooms, gardens, etc. these are known as defined scope schemes (DS).

In order to achieve and maintain competent person status, all approval bodies require an initial and thereafter annual registration fee and inspection visit.

**Approval bodies** (full scope FS and defined scope DS)

NICEIC	(FS) & (DS)	0870 013 0900
NAPIT	(FS) & (DS)	0870 444 1392
ELESCA	(FS) & (DS)	0870 749 0080

BSI	(FS)	01442 230 442
BRE	(FS)	0870 609 6093
CORGI	(DS)	01256 392 200
OFTEC	(DS)	0845 658 5080

**Table 1.1** Examples of Work Notifiable and Not Notifiable.

Notifiable (YES)	Not Notifiable (NO)	Not Applicable (N/A)
<b>Examples of Work</b>	<b>Location A</b> <b>Within Kitchens,</b> <b>Bath/Shower Room,</b> <b>Gardens, Swimming/ Paddling Pools and</b> <b>Hot Air Saunas</b>	<b>Location B</b> <b>Outside of</b> <b>Location A</b>
A complete new installation or rewire	<b>YES</b>	<b>YES</b>
Consumer unit change	<b>YES</b>	<b>YES</b>
Installing a new final circuit (e.g. for lighting, socket outlets, a shower or a cooker)	<b>YES</b>	<b>YES</b>
Fitting and connecting an electric shower to an existing wiring point	<b>YES</b>	<b>N/A</b>
Adding a socket outlet to an existing final circuit	<b>YES</b>	<b>NO</b>
Adding a lighting point to an existing final circuit	<b>YES</b>	<b>NO</b>
Adding a fused connection unit to an existing final circuit	<b>YES</b>	<b>NO</b>
Installing and fitting a storage heater including final circuit	<b>YES</b>	<b>YES</b>
Installing extra-low voltage lighting (other than pre-assembled CE marked sets)	<b>YES</b>	<b>YES</b>
Installing a new supply to a garden shed or other building	<b>YES</b>	<b>N/A</b>
Installing a socket outlet or lighting point in a garden shed or other detached outbuilding	<b>YES</b>	<b>N/A</b>
Installing a garden pond pump, including supply	<b>YES</b>	<b>N/A</b>

(continued)

## 14 IEE Wiring Regulations: Explained and Illustrated

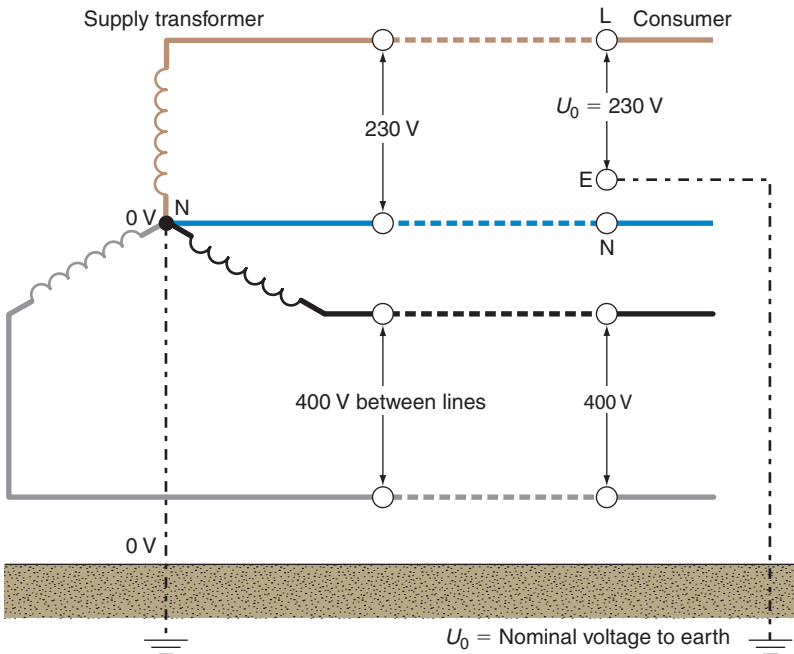
**Table 1.1** *Continued*

Notifiable (YES)	Not Notifiable (NO)	Not Applicable (N/A)
Examples of Work	Location A Within Kitchens, Bath/Shower Room, Gardens, Swimming/ Paddling Pools and Hot Air Saunas	Location B Outside of Location A
Installing an electric hot air sauna	YES	N/A
Installing a solar photovoltaic power supply	YES	YES
Installing electric ceiling or floor heating	YES	YES
Installing an electricity generator	YES	YES
Installing telephone or extra low-voltage wiring and equipment for communications, information technology, signalling, control or similar purposes	YES	NO
Installing a socket outlet or lighting point outdoors	YES	YES
Installing or upgrading main or supplementary equipotential bonding	NO	NO
Connecting a cooker to an existing connection unit	NO	NO
Replacing a damaged cable for a single circuit, on a like-for-like basis	NO	NO
Replacing a damaged accessory, such as a socket outlet	NO	NO
Replacing a lighting fitting	NO	NO
Providing mechanical protection to an existing fixed installation	NO	NO
Fitting and final connection of storage heater to an existing adjacent wiring point	NO	NO
Connecting an item of equipment to an existing adjacent connection point	NO	NO
Replacing an immersion heater	NO	NO
Installing an additional socket outlet in a motor caravan	N/A	N/A

Appendix 2 of the IEE Regulations lists all of the other Statutory Regulations and Memoranda with which electrical installations must comply.

It is interesting to note that if an installation fails to comply with Chapter 13 of the Regulations, the DNO has the right to refuse to give a supply or, in certain circumstances, to disconnect it.

While we are on the subject of DNOs, let us look at the current declared supply voltages and tolerances. In order to align with European Harmonized Standards, our historic 415V/240V declared supply voltages have now become 400V/230V. However,



Note: The connection of the transformer star or neutral point to earth helps to maintain that point at or very near zero volts.

**FIGURE 1.2** DNO Supply Voltages.

this is only a paper exercise, and it is unlikely that consumers will notice any difference for many years, if at all. Let me explain, using single phase as the example.

The supply industry declared voltage was  $240\text{V} \pm 6\%$ , giving a range between  $225.6\text{V}$  and  $254.4\text{V}$ . The new values are  $230\text{V} + 10\% - 6\%$ , giving a range between  $216.2\text{V}$  and  $253\text{V}$ . Not a lot of difference. The industry has done nothing physical to reduce voltages from  $240\text{V}$  to  $230\text{V}$ , it is just the declaration that has been altered. Hence a measurement of voltage at supply terminals will give similar readings to those we have always known. Figure 1.2 shows the UK supply system and associated declared voltages.

BS 7671 details two voltage categories, Band 1 and Band 2. Band 1 is essentially Extra low voltage (ELV) systems and Band 2 Low voltage (LV) systems.

ELV is less than  $50\text{V AC}$  between conductors or to earth. LV exceeds ELV up to  $1000\text{V AC}$  between conductors and  $600\text{V}$  between conductors and earth.

The suppliers are now governed by the 'Electricity Safety, Quality & Continuity Regulations 2002' (formerly the Electricity Supply Regulations 1988).

# Earthing

☞ Relevant BS 7671 chapters and parts: Chapters 31, 41, 54, Part 7

## DEFINITIONS USED IN THIS CHAPTER

**Basic protection** Protection against electric shock under fault-free conditions.

**Bonding conductor** A protective conductor providing equipotential bonding.

**Circuit protective conductor (cpc)** A protective conductor connecting exposed conductive parts of equipment to the main earthing terminal.

**Earth** The conductive mass of earth, whose electric potential at any point is conventionally taken as zero.

**Earth electrode resistance** The resistance of an earth electrode to earth.

**Earth fault current** An overcurrent resulting from a fault of negligible impedance between a line conductor and an exposed conductive part or a protective conductor.

**Earth fault loop impedance** The impedance of the phase-to-earth loop path starting and ending at the point of fault.

**Earthing conductor** A protective conductor connecting a main earthing terminal of an installation to an earth electrode or other means of earthing.

**Equipotential bonding** Electrical connection maintaining various exposed conductive parts and extraneous conductive parts at a substantially equal potential.

**Exposed conductive part** A conductive part of equipment which can be touched and which is not a live part but which may become live under fault conditions.

**Extraneous conductive part** A conductive part liable to introduce a potential, generally earth potential, and not forming part of the electrical installation.

**Fault protection** Protection against electric shock under single-fault conditions.

**Functional earth** Earthing of a point or points in a system or an installation or in equipment for purposes other than safety, such as for proper functioning of electrical equipment.

**Leakage current** Electric current in an unwanted conductive part under normal operating conditions.

**Line conductor** A conductor of an AC system for the transmission of electrical energy, other than a neutral conductor.

**Live part** A conductor or conductive part intended to be energized in normal use, including a neutral conductor but, by convention, not a PEN conductor.

**PEN conductor** A conductor combining the functions of both protective conductor and neutral conductor.

**PME (protective multiple earthing)** An earthing arrangement, found in TN-C-S systems, where an installation is earthed via the supply neutral conductor.

**Protective conductor** A conductor used for some measure of protection against electric shock and intended for connecting together any of the following parts:

- exposed conductive parts
- extraneous conductive parts
- main earthing terminal
- earth electrode(s)
- earthed point of the source.

**Residual current device (RCD)** An electromechanical switching device or association of devices intended to cause the opening of the contacts when the residual current attains a given value under given conditions.

**Simultaneously accessible parts** Conductors or conductive parts which can be touched simultaneously by a person or, where applicable, by livestock.

## EARTH: WHAT IT IS, AND WHY AND HOW WE CONNECT TO IT

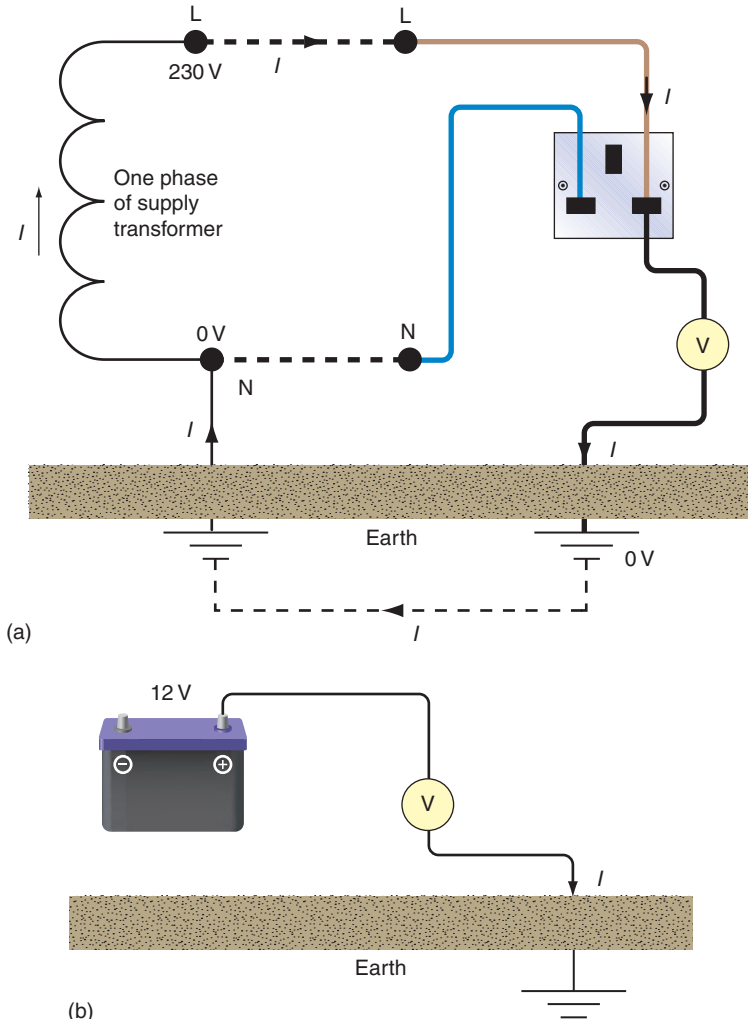
The thin layer of material which covers our planet, be it rock, clay, chalk or whatever, is what we in the world of electricity refer to as earth. So, why do we need to connect anything to it? After all, it is not as if earth is a good conductor.

Perhaps it would be wise at this stage to investigate potential difference (PD). A PD is exactly what it says it is: a difference in potential (volts). Hence, two conductors having PDs of, say, 20V and 26V have a PD between them of  $26 - 20 = 6V$ . The original PDs, i.e. 20V and 26V, are the PDs between 20V and 0V and 26V and 0V.

So where does this 0V or zero potential come from? The simple answer is, in our case, the earth. The definition of earth is therefore

the conductive mass of earth, whose electric potential at any point is conventionally taken as zero.

Hence, if we connect a voltmeter between a live part (e.g. the line conductor of, say, a socket outlet circuit) and earth, we may read

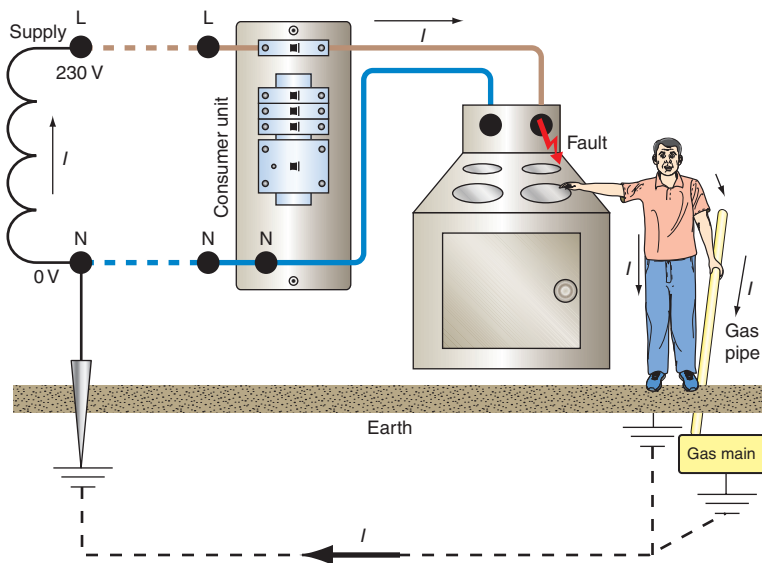


**FIGURE 2.1** (a) Earth path, (b) No earth path.

230 V; the conductor is at 230 V, the earth at zero. The earth provides a path to complete the circuit. We would measure nothing at all if we connected our voltmeter between, say, the positive 12 V terminal of a car battery and earth, as in this case the earth plays no part in any circuit. Figure 2.1 illustrates this difference.

Hence, a person in an installation touching a live part whilst standing on the earth would take the place of the voltmeter in Figure 2.1a, and could suffer a severe electric shock. Remember that the accepted lethal level of shock current passing through a person is only 50 mA or 1/20 A. The same situation would arise if the person were touching, say, a faulty appliance and a gas or water pipe (Figure 2.2).

One method of providing some measure of protection against these effects is to join together (bond) all metallic parts and connect them to earth. This ensures that all metalwork in a healthy



**FIGURE 2.2** Shock path.

situation is at or near zero volts, and under fault conditions all metalwork will rise to a similar potential. So, simultaneous contact with two such metal parts would not result in a dangerous shock, as there will be no significant PD between them. This method is known as protective equipotential bonding.

Unfortunately, as previously mentioned, earth itself is not a good conductor unless it is very wet, and therefore it presents a high resistance to the flow of fault current. This resistance is usually enough to restrict fault current to a level well below that of the rating of the protective device, leaving a faulty circuit uninterrupted. Clearly this is an unhealthy situation. The methods of overcoming this problem will be dealt with later.

In all but the most rural areas, consumers can connect to a metallic earth return conductor which is ultimately connected to the earthed neutral of the supply. This, of course, presents a low-resistance path for fault currents to operate the protection.

Summarizing, then, connecting metalwork to earth places that metal at or near zero potential, and bonding between metallic parts puts such parts at a similar potential even under fault conditions.

### **Connecting to earth**

In the light of previous comments, it is obviously necessary to have as low an earth path resistance as possible, and the point of connection to earth is one place where such resistance may be reduced. When two conducting surfaces are placed in contact with each other, there will be a resistance to the flow of current dependent on the surface areas in contact. It is clear, then, that the greater surface contact area with earth that can be achieved, the better.

There are several methods of making a connection to earth, including the use of rods, plates and tapes. By far the most popular

method in everyday use is the rod earth electrode. The plate type needs to be buried at a sufficient depth to be effective and, as such plates may be 1 or 2 metres square, considerable excavation may be necessary. The tape type is predominantly used in the earthing of large electricity substations, where the tape is laid in trenches in a mesh formation over the whole site. Items of plant are then earthed to this mesh.

### **Rod electrodes**

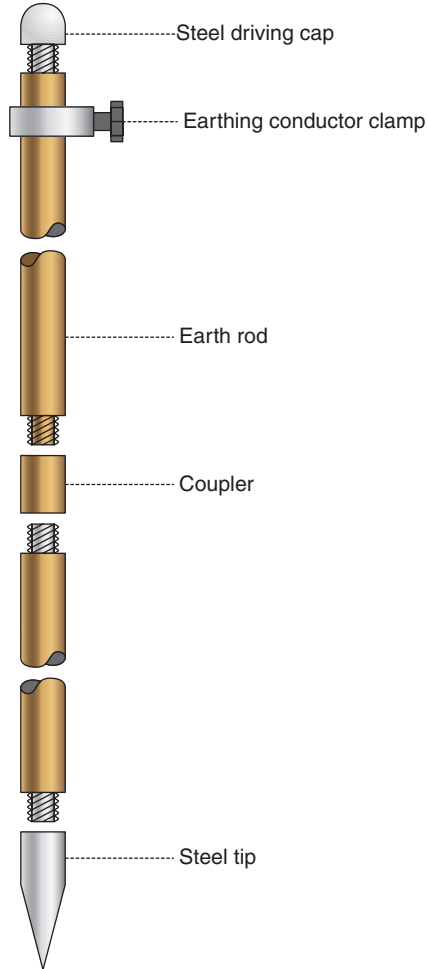
These are usually of solid copper or copper-clad carbon steel, the latter being used for the larger-diameter rods with extension facilities. These facilities comprise: a thread at each end of the rod to enable a coupler to be used for connection of the next rod; a steel cap to protect the thread from damage when the rod is being driven in; a steel driving tip; and a clamp for the connection of an earth tape or conductor (Figure 2.3).

The choice of length and diameter of such a rod will, as previously mentioned, depend on the soil conditions. For example, a long thick electrode is used for earth with little moisture retention. Generally, a 1–2 m rod, 16 mm in diameter, will give a relatively low resistance.

## **EARTH ELECTRODE RESISTANCE**

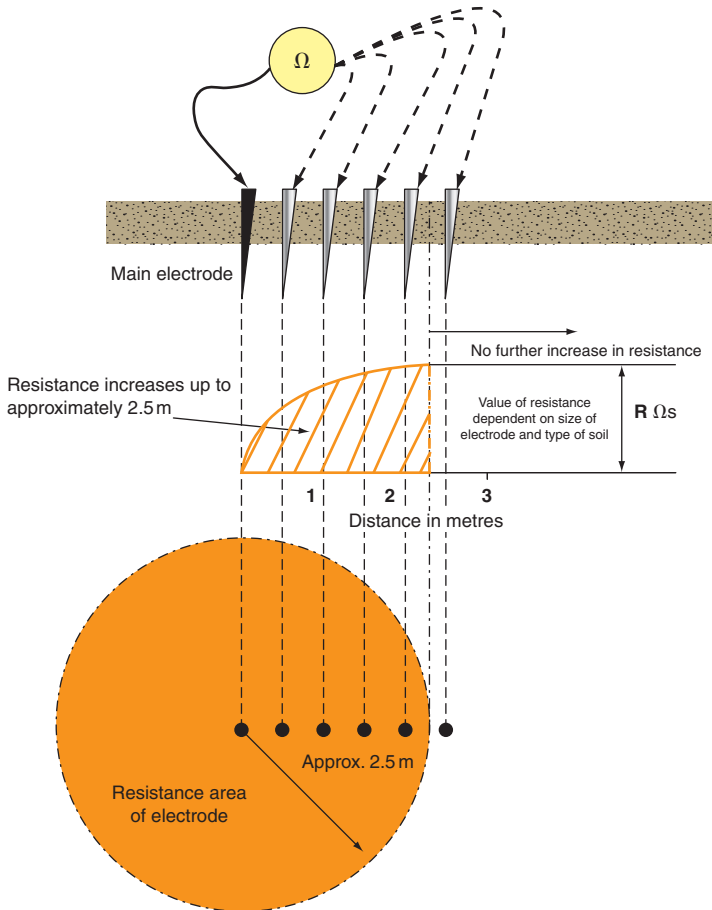
If we were to place an electrode in the earth and then measure the resistance between the electrode and points at increasingly larger distance from it, we would notice that the resistance increased with distance until a point was reached (usually around 2.5 m) beyond which no increase in resistance was noticed (Figure 2.4, see page 25).

The resistance area around the electrode is particularly important with regard to the voltage at the surface of the ground (Figure 2.5, see page 26). For a 2 m rod, with its top at ground level, 80–90%



**FIGURE 2.3** Earth rod.

of the voltage appearing at the electrode under fault conditions is dropped across the earth in the first 2.5 to 3m. This is particularly dangerous where livestock is present, as the hind and fore legs of an animal can be respectively inside and outside the resistance area: a PD of 25V can be lethal! One method of overcoming



**FIGURE 2.4** Earth electrode resistance area.

this problem is to house the electrode in a pit below ground level (Figure 2.6) as this prevents voltages appearing at ground level.

## EARTHING IN THE IEE REGULATIONS (IEE REGULATIONS CHAPTER 4, SECTION 411)

In the preceding pages we have briefly discussed the reasons for, and the importance and methods of, earthing. Let us now examine the subject in relation to the IEE Regulations.

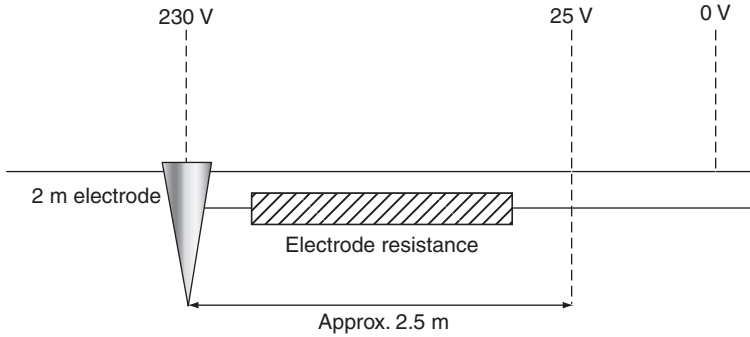


FIGURE 2.5

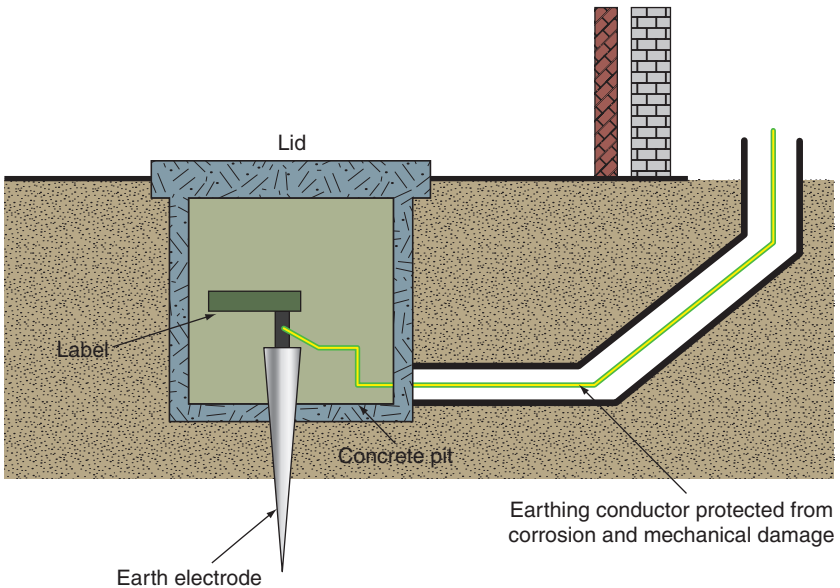


FIGURE 2.6 Earth electrode installation.

Contact with metalwork made live by a fault is clearly undesirable. One popular method of providing some measure of protection against the effects of such contact is by protective earthing, protective equipotential bonding and automatic disconnection in

the event of a fault. This entails the bonding together and connection to earth of:

1. All metalwork associated with electrical apparatus and systems, termed exposed conductive parts. Examples include conduit, trunking and the metal cases of apparatus.
2. All metalwork liable to introduce a potential including earth potential, termed extraneous conductive parts. Examples are gas, oil and water pipes, structural steelwork, radiators, sinks and baths.

The conductors used in such connections are called *protective conductors*, and they can be further subdivided into:

1. Circuit protective conductors, for connecting exposed conductive parts to the main earthing terminal.
2. Main protective bonding conductors, for bonding together main incoming services, structural steelwork, etc.
3. Supplementary bonding conductors for bonding exposed conductive parts and extraneous conductive parts, when circuit disconnection times cannot be met, or in special locations, such as bathrooms, swimming pools, etc.

The effect of all this bonding is to create a zone in which all metalwork of different services and systems will, even under fault conditions, be at a substantially equal potential. If, added to this, there is a low-resistance earth return path, the protection should operate fast enough to prevent danger (IEE Regulations 411.3 to 411.6).

The resistance of such an earth return path will depend upon the system (see the next section), either TT, TN-S or TN-C-S (IT systems will not be discussed here, as they are extremely rare and unlikely to be encountered by the average contractor).

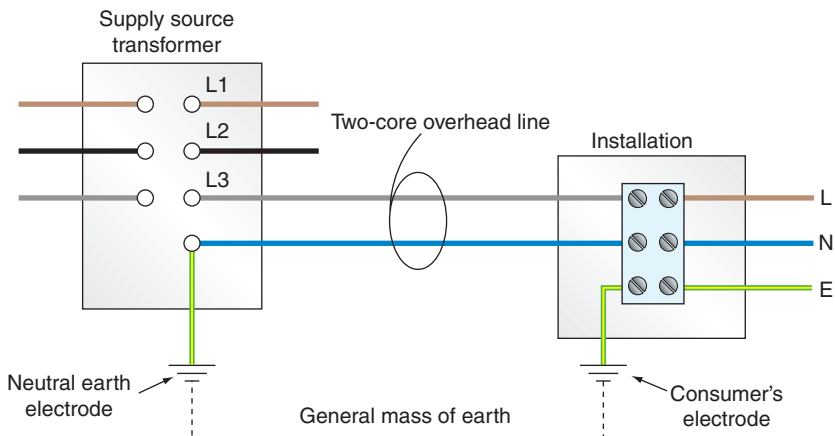
## EARTHING SYSTEMS (IEE REGULATIONS DEFINITIONS (SYSTEMS))

These have been designated in the IEE Regulations using the letters T, N, C and S. These letters stand for:

- T** terre (French for earth) and meaning a direct connection to earth
- N** neutral
- C** combined
- S** separate.

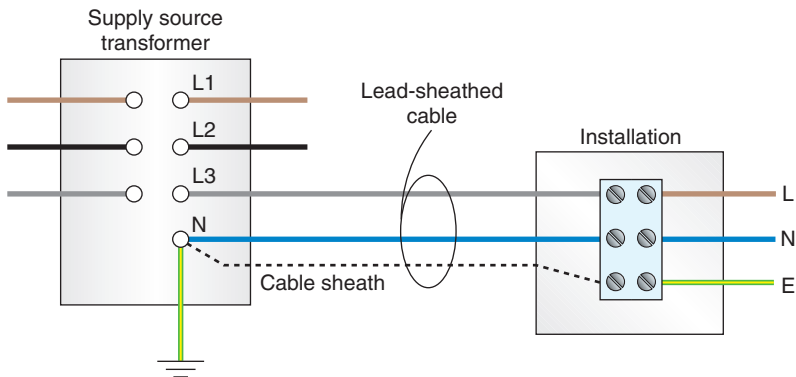
When these letters are grouped they form the classification of a type of system. The first letter in such a classification denotes how the supply source is earthed. The second denotes how the metalwork of an installation is earthed. The third and fourth indicate the functions of neutral and protective conductors. Hence:

1. A TT system has a direct connection of the supply source neutral to earth and a direct connection of the installation metalwork to earth. An example is an overhead line supply with earth electrodes, and the mass of earth as a return path (Figure 2.7).

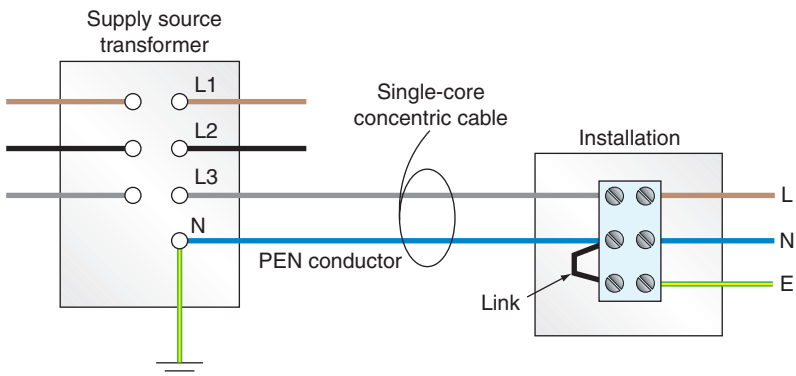


**FIGURE 2.7** TT system.

2. A TN-S system has the supply source neutral directly connected to earth, the installation metalwork connected to the earthed neutral of the supply source via the lead sheath of the supply cable, and the neutral and protective conductors throughout the whole system performing separate functions (Figure 2.8).
3. A TN-C-S system is as the TN-S but the supply cable sheath is also the neutral, i.e. it forms a combined earth/neutral conductor known as a PEN (protective earthed neutral) conductor (Figure 2.9).



**FIGURE 2.8** TN-S system.



**FIGURE 2.9** TN-C-S system.

The installation earth and neutral are separate conductors. This system is also known as PME.

Note that only single-phase systems have been shown, for simplicity.

### Summary

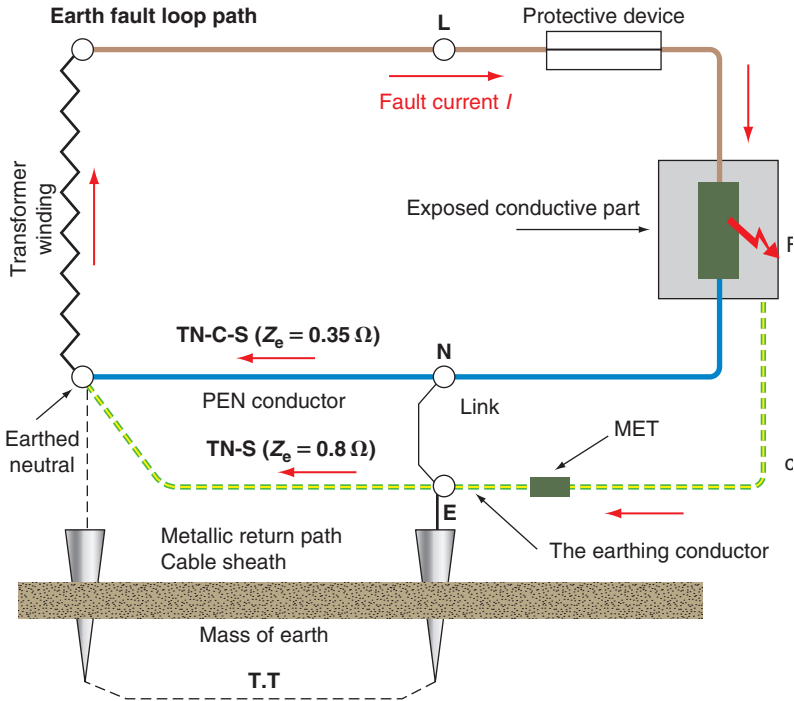
In order to reduce the risk of serious electric shock, it is important to provide a path for earth fault currents to operate the circuit protection, and to endeavour to maintain all metalwork at a substantially equal potential. This is achieved by bonding together metalwork of electrical and non-electrical systems to earth. The path for earth fault currents would then be via the earth itself in TT systems or by a metallic return path in TN-S or TN-C-S systems.

### EARTH FAULT LOOP IMPEDANCE

As we have seen, circuit protection should operate in the event of a direct fault from line to earth (automatic disconnection). The speed of operation of the protection is extremely important and will depend on the magnitude of the fault current, which in turn will depend on the impedance of the earth fault loop path,  $Z_s$ .

Figure 2.10 shows this path. Starting at the fault, the path comprises:

1. The cpc.
2. The consumer's earthing terminal and earth conductor.
3. The return path, either metallic or earth, dependent on the earthing system.
4. The earthed neutral of the supply transformer.



**FIGURE 2.10** Earth fault loop path.

5. The transformer winding.
6. The line conductor from the transformer to the fault.

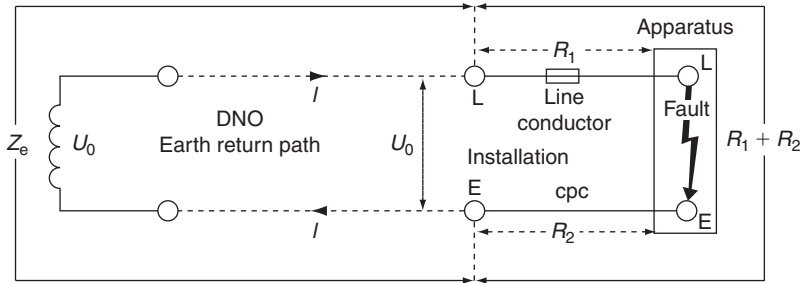
Figure 2.11 is a simplified version of this path. We have:

$$Z_s = Z_e + R_1 + R_2$$

where  $Z_s$  is the actual total loop impedance,  $Z_e$  is the loop impedance external to the installation,  $R_1$  is the resistance of the line conductor, and  $R_2$  is the resistance of the cpc. We also have:

$$I = U_0 / Z_s$$

where  $I$  is the fault current and  $U_0$  is the nominal line voltage to earth.



**FIGURE 2.11** Simplified loop path.

## DETERMINING THE VALUE OF TOTAL LOOP IMPEDANCE

The IEE Regulations require that when the general characteristics of an installation are assessed, the loop impedance  $Z_e$  external to the installation shall be ascertained.

This may be measured in existing installations using a line-to-earth loop impedance tester. However, when a building is only at the drawing board stage it is clearly impossible to make such a measurement. In this case, we have three methods available to assess the value of  $Z_e$ :

1. Determine it from details (if available) of the supply transformer, the main distribution cable and the proposed service cable; or
2. Measure it from the supply intake position of an adjacent building having service cable of similar size and length to that proposed; or
3. Use maximum likely values issued by the supply authority as follows:
  - TT system:  $21\Omega$  maximum
  - TN-S system:  $0.80\Omega$  maximum
  - TN-C-S system:  $0.35\Omega$  maximum.

Method 1 will be difficult for anyone except engineers. Method 3 can, in some cases, result in pessimistically large cable sizes. Method 2, if it is possible to be used, will give a closer and more realistic estimation of  $Z_c$ . However, if in any doubt, use method 3.

Having established a value for  $Z_e$ , it is now necessary to determine the impedance of that part of the loop path internal to the installation. This is, as we have seen, the resistance of the line conductor plus the resistance of the cpc, i.e.  $R_1 + R_2$ . Resistances of copper conductors may be found from manufacturers' information which gives values of resistance/metre for copper and aluminium conductors at 20°C in mΩ/m. Table 2.1 gives resistance values for copper conductors up to 35 mm<sup>2</sup>.

**Table 2.1** Resistance of Copper Conductors at 20°C.

<b>Conductor CSA (mm<sup>2</sup>)</b>	<b>Resistance (mΩ/m)</b>
1.0	18.1
1.5	12.1
2.5	7.41
4.0	4.61
6.0	3.08
10.0	1.83
16.0	1.15
25.0	0.727
35.0	0.524

A 25 mm<sup>2</sup> line conductor with a 4 mm<sup>2</sup> cpc has  $R_1 = 0.727$  and  $R_2 = 4.61$ , giving  $R_1 + R_2 = 0.727 + 4.61 = 5.337$  mΩ/m. So, having established a value for  $R_1 + R_2$ , we must now multiply it by the length of the run and divide by 1000 (the values given are in mΩ/m). However, this final value is based on a temperature of 20°C, but when the conductor is fully loaded its temperature will increase. In order to determine the value of resistance at conductor operating temperature, a multiplier is used.

This multiplier, applied to the 20°C value of resistance, is determined from the following formula:

$$R_t = R_{20} \{1 + \alpha_{20}(\theta - 20)\}$$

where

$R_t$  = the resistance at conductor operating temperature

$R_{20}$  = the resistance at 20°C

$\alpha_{20}$  = the 20°C temperature coefficient of copper,  
0.004  $\Omega/\Omega^\circ\text{C}$

$\theta$  = the conductor operating temperature.

Clearly, the multiplier is  $\{1 + \alpha_{20}(\theta - 20)\}$ .

So, for a 70°C thermoplastic insulated conductor (Table 54C IEE Regulations), the multiplier becomes:

$$\{1 + 0.004(70^\circ - 20^\circ)\} = 1.2$$

And for a 90°C XLPE type cable it becomes:

$$\{1 + 0.004(90^\circ - 20^\circ)\} = 1.28$$

Hence, for a 20 m length of 70°C PVC insulated 16 mm<sup>2</sup> line conductor with a 4 mm<sup>2</sup> cpc, the value of  $R_1 + R_2$  would be:

$$R_1 + R_2 = [(1.15 + 4.61) \times 20 \times 1.2] / 1000 = 0.138 \Omega$$

We are now in a position to determine the total earth fault loop impedance  $Z_s$  from:

$$Z_s = Z_e + R_1 + R_2$$

As previously mentioned, this value of  $Z_s$  should be as low as possible to allow enough fault current to flow to operate the protection as quickly as possible. Tables 41.2, 41.3 and 41.4 of the IEE Regulations give maximum values of loop impedance for different

sizes and types of protection for both final circuits, and distribution circuits.

Provided that the actual values calculated do not exceed those tabulated, final circuits up to 32A will disconnect under earth fault conditions in 0.4s or less, and distribution circuits in 5s or less. The reasoning behind these different times is based on the time that a faulty circuit can reasonably be left uninterrupted. Hence, socket outlet circuits from which hand-held appliances may be used clearly present a greater shock risk than distribution circuits. It should be noted that these times, i.e. 0.4s and 5s, do not indicate the duration that a person can be in contact with a fault. They are based on the probable chances of someone being in contact with exposed or extraneous conductive parts at the precise moment that a fault develops.

☞ See also Table 41.1 of the IEE Regulations.

### Example 2.1

Let us now have a look at a typical example of, say, a shower circuit run in an 18m length of 6.0mm<sup>2</sup> (6242Y) twin cable with cpc, and protected by a 30A BS 3036 semi-enclosed rewirable fuse. A 6.0mm<sup>2</sup> twin cable has a 2.5mm<sup>2</sup> cpc. We will also assume that the external loop impedance  $Z_e$  is measured as 0.27Ω. Will there be a shock risk if a line-to-earth fault occurs?

The total loop impedance  $Z_s = Z_e + R_1 + R_2$ . We are given  $Z_e = 0.27\Omega$ .

For a 6.0mm<sup>2</sup> line conductor with a 2.5mm<sup>2</sup> cpc,  $R_1 + R_2$  is 10.49mΩ/m. Hence, with a multiplier of 1.2 for 70°C PVC,

$$\text{total } R_1 + R_2 = 18 \times 10.49 \times 1.2 / 1000 = 0.23\Omega$$

Therefore,  $Z_s = 0.27 + 0.23 = 0.5\Omega$ . This is less than the 1.09Ω maximum given in Table 41.2 for a 30A BS 3036 fuse. Hence, the protection will disconnect the circuit in less than 0.4s. In fact it will disconnect in less than 0.1s; the determination of this time will be dealt with in Chapter 5.

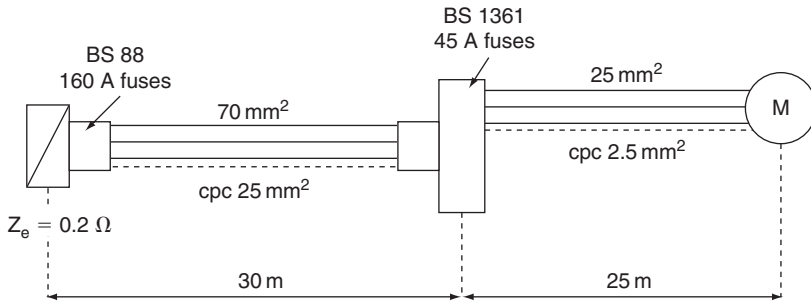
**Example 2.2**

Consider, now, a more complex installation, and note how the procedure remains unchanged.

In this example, a three-phase motor is fed using 25mm<sup>2</sup> single PVC conductors in trunking, the cpc being 2.5mm<sup>2</sup>. The circuit is protected by BS 1361 45A fuses in a distribution fuseboard. The distribution circuit or sub-main feeding this fuseboard comprises 70mm<sup>2</sup> PVC singles in trunking with a 25mm<sup>2</sup> cpc, the protection being by BS 88 160A fuses. The external loop impedance  $Z_e$  has a measured value of 0.2Ω. Will this circuit arrangement comply with the shock-risk constraints?

The formula  $Z_s = Z_e + R_1 + R_2$  must be extended, as the  $(R_1 + R_2)$  component comprises both the distribution and motor circuits; it therefore becomes:

$$Z_s = Z_e + (R_1 + R_2)_1 + (R_1 + R_2)_2$$



**FIGURE 2.12**

**Distribution circuit  $(R_1 + R_2)_1$**

This comprises 30m of 70mm<sup>2</sup> line conductor and 30m of 25mm<sup>2</sup> cpc. Typical values for conductors over 35mm<sup>2</sup> are shown in Table 2.2.

As an alternative we can use our knowledge of the relationship between conductor resistance and area, e.g. a 10mm<sup>2</sup> conductor

**Table 2.2**

Area of Conductor (mm <sup>2</sup> )	Resistance (mΩ/m) Copper	Aluminium
50	0.387	0.641
70	0.263	0.443
95	0.193	0.320
120	0.153	0.253
185	0.0991	0.164
240	0.0754	0.125
300	0.0601	0.1

has approximately 10 times less resistance than a 1.0 mm<sup>2</sup> conductor:

$$10 \text{ mm}^2 \text{ resistance} = 1.83 \text{ m}\Omega/\text{m}$$

$$1.0 \text{ mm}^2 \text{ resistance} = 18.1 \text{ m}\Omega/\text{m}$$

Hence a 70 mm<sup>2</sup> conductor will have a resistance approximately half that of a 35 mm<sup>2</sup> conductor:

$$35 \text{ mm}^2 \text{ resistance} = 0.524 \text{ m}\Omega/\text{m}$$

$$\therefore 70 \text{ mm}^2 \text{ resistance} = \frac{0.524}{2} = 0.262 \text{ m}\Omega/\text{m}$$

which compares well with the value given in Table 2.2.

$$25 \text{ mm}^2 \text{ cpc resistance} = 0.727 \text{ m}\Omega/\text{m}$$

so the distribution circuit

$$(R_1 + R_2)_1 = 30 \times (0.262 + 0.727) \times 1.2 / 1000 = 0.035 \Omega$$

Hence  $Z_s = Z_e + (R_1 + R_2)_1 = 0.2 + 0.035 = 0.235 \Omega$ , which is less than the  $Z_s$  maximum of 0.25 Ω quoted for a 160 A BS 88 fuse in Table 41.3 of the Regulations.

### Motor circuit $(R_1 + R_2)_2$

Here we have 25 m of 25 mm<sup>2</sup> line conductor with 25 m of 2.5 mm<sup>2</sup> cpc. Hence:

$$\begin{aligned}(R_1 + R_2)_2 &= 25 \times (0.727 + 7.41) \times 1.2/1000 \\ &= 0.24 \Omega\end{aligned}$$

$$\begin{aligned}\therefore \text{Total } Z_s &= Z_e + (R_1 + R_2)_1 + (R_1 + R_2)_2 \\ &= 0.2 + 0.035 + 0.24 = 0.48 \Omega\end{aligned}$$

which is less than the  $Z_s$  maximum of 0.96  $\Omega$  quoted for a 45 A BS 1361 fuse from Table 41.3 of the Regulations. Hence we have achieved compliance with the shock-risk constraints.

## ADDITIONAL PROTECTION

### Residual current devices

The following list indicates the ratings and uses of RCDs detailed in BS 7671.

### Requirements for RCD protection

#### 30 mA

- All socket outlets rated at not more than 20 A and for un-supervised general use
- Mobile equipment rated at not more than 32 A for use outdoors
- All circuits in a bath/shower room
- Preferred for all circuits in a TT system
- All cables installed less than 50 mm from the surface of a wall or partition (in the safe zones) if the installation is unsupervised, and also at any depth if the construction of the wall or partition includes metallic parts

- In zones 0, 1 and 2 of swimming pool locations
- All circuits in a location containing saunas, etc.
- Socket outlet final circuits not exceeding 32 A in agricultural locations
- Circuits supplying Class II equipment in restrictive conductive locations
- Each socket outlet in caravan parks and marinas and final circuit for houseboats
- All socket outlet circuits rated not more than 32 A for show stands, etc.
- All socket outlet circuits rated not more than 32 A for construction sites (where reduced low voltage, etc. is not used)
- All socket outlets supplying equipment outside mobile or transportable units
- All circuits in caravans
- All circuits in circuses, etc.
- A circuit supplying Class II heating equipment for floor and ceiling heating systems.

### **100 mA**

- Socket outlets of rating exceeding 32 A in agricultural locations.

### **300 mA**

- At the origin of a temporary supply to circuses, etc.
- Where there is a risk of fire due to storage of combustible materials
- All circuits (except socket outlets) in agricultural locations.

### **500 mA**

- Any circuit supplying one or more socket outlets of rating exceeding 32 A, on a construction site.

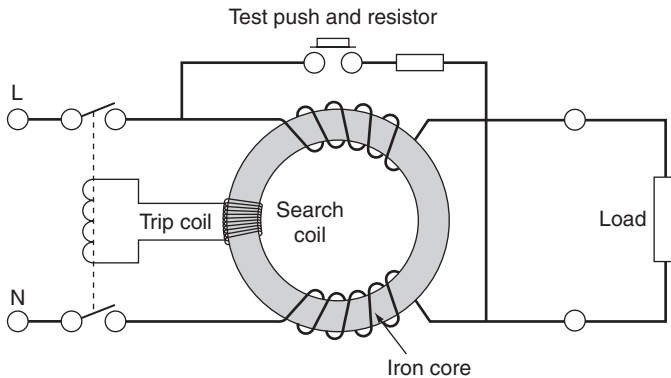
We have seen the importance of the total earth loop impedance  $Z_s$  in the reduction of shock risk.

However, in some systems and especially TT, where the maximum values of  $Z_s$  given in Tables 41.2, 41.3 and 41.4 of the Regulations may be hard to satisfy, an RCD may be used: its residual rating being determined from:

$$I_{\Delta n} \leq 50/Z_s$$

### Principle of operation of an RCD

Figure 2.13 illustrates the construction of an RCD. In a healthy circuit the same current passes through the line coil, the load, and back through the neutral coil. Hence the magnetic effects of line and neutral currents cancel out.



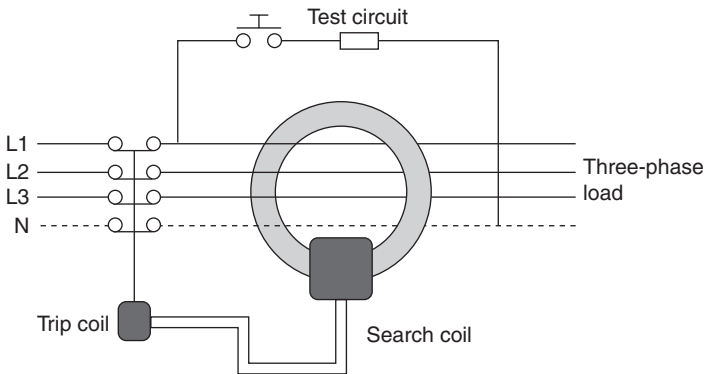
**FIGURE 2.13** Residual current device.

In a faulty circuit, either line to earth or neutral to earth, these currents are no longer equal. Therefore the out-of-balance current produces some residual magnetism in the core. As this magnetism is alternating, it links with the turns of the search coil, inducing an

electro-motive force (EMF) in it. This EMF in turn drives a current through the trip coil, causing operation of the tripping mechanism.

It should be noted that a line-to-neutral fault will appear as a load, and hence the RCD will not operate for this fault.

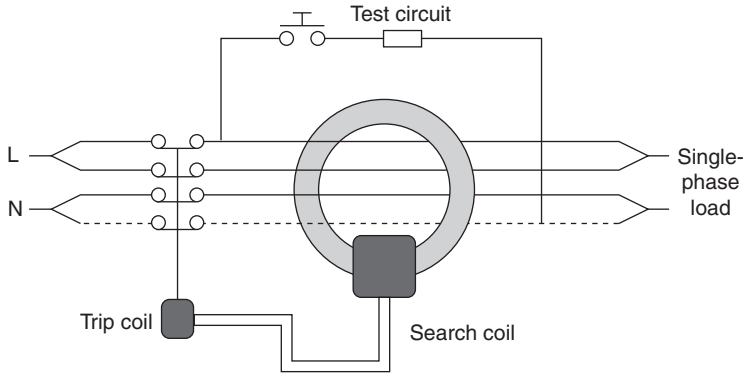
A three-phase RCD works on the same out-of-balance principle; in this case the currents flowing in the three lines when they are all equal sum to zero, hence there is no resultant magnetism. Even if they are unequal, the out-of-balance current flows in the neutral which cancels out this out-of-balance current. Figure 2.14 shows the arrangement of a three-phase RCD, and Figure 2.15 how it can be connected for use on single-phase circuits.



**FIGURE 2.14** Three-phase RCD.

## Nuisance tripping

Certain appliances such as cookers, water heaters and freezers tend to have, by the nature of their construction and use, some leakage currents to earth. These are quite normal, but could cause the operation of an RCD protecting an entire installation. This can be overcome by using split-load consumer units, where socket outlet



**FIGURE 2.15** Connections for single phase.

circuits are protected by a 30 mA RCD, leaving all other circuits controlled by a normal mains switch. Better still, especially in TT systems, is the use of a 100 mA RCD for protecting circuits other than socket outlets.

Modern developments in CB, RCD and consumer unit design now make it easy to protect any individual circuit with a combined CB/RCD (RCBO), making the use of split-load boards unnecessary.

An exception to the 30 mA RCD requirement for socket outlet circuits can be achieved by providing an indication that a particular socket outlet or outlets are not for general use, e.g. freezers, etc. This, of course, means the installation of a separate non-RCD protected circuit.

### Supplementary bonding (IEE Regulations Section 415.2)

In general the only Supplementary bonding required is for special locations such as bathrooms (not always needed – see Chapter 7), swimming pools, agricultural premises, etc. and where disconnection times cannot be met.

By now we should know why bonding is necessary; the next question, however, is to what extent bonding should be carried out. This is perhaps answered best by means of question and answer examples:

**1. Do I need to bond the hot and cold taps and a metal kitchen sink together? Surely they are all joined anyway?**

Provided that main protective bonding conductors have been correctly installed there is no specific requirement in BS 7671 to do this.

**2. Do I have to bond radiators in a premises to, say, metal-clad switches or socket outlets, etc.?**

Supplementary bonding is only necessary when extraneous conductive parts are simultaneously accessible with exposed conductive parts and the disconnection time for the circuit concerned cannot be achieved. In these circumstances the bonding conductor should have a resistance  $R \leq 50/I_a$ , where  $I_a$  is the operating current of the protection.

**3. Do I need to bond metal window frames?**

In general, no. Apart from the fact that most window frames will not introduce a potential from anywhere, the part of the window most likely to be touched is the opening portion, to which it would not be practicable to bond. There may be a case for the bonding if the frames were fortuitously touching structural steel work.

**4. What about bonding in bathrooms?**

Refer to Chapter 7.

**5. What size of bonding conductors should I use?**

Main protective bonding conductors should be not less than half the size of the main earthing conductor, subject to a minimum of  $60\text{ mm}^2$  or, where PME (TN-C-S) conditions are

present, 10.0mm<sup>2</sup>. For example, most new domestic installations now have a 16.0mm<sup>2</sup> earthing conductor, so all main bonding will be in 10.0mm<sup>2</sup>. Supplementary bonding conductors are subject to a minimum of 2.5mm<sup>2</sup> if mechanically protected or 4.0mm<sup>2</sup> if not. However, if these bonding conductors are connected to exposed conductive parts, they must be the same size as the cpc connected to the exposed conductive part, once again subject to the minimum sizes mentioned. It is sometimes difficult to protect a bonding conductor mechanically throughout its length, and especially at terminations, so it is perhaps better to use 4.0mm<sup>2</sup> as the minimum size.

### **6. Do I have to bond free-standing metal cabinets, screens, workbenches, etc.?**

No. These items will not introduce a potential into the equipotential zone from outside, and cannot therefore be regarded as extraneous conductive parts.

### **The Faraday cage**

In one of his many experiments, Michael Faraday (1791–1867) placed an assistant in an open-sided cube which was then covered in a conducting material and insulated from the floor. When this cage arrangement was charged to a high voltage, the assistant found that he could move freely within it, touching any of the sides, with no adverse effects. Faraday had, in fact, created an equipotential zone, and of course in a correctly bonded installation, we live and/or work in Faraday cages!

# Protection

- ☞ Relevant IEE parts, chapters and sections: Part 4, Chapters 41, 42, 43, 44; Part 5, Chapter 53

## DEFINITIONS USED IN THIS CHAPTER

**Arm's reach** A zone of accessibility to touch, extending from any point on a surface where persons usually stand or move about, to the limits which a person can reach with his hand in any direction without assistance.

**Barrier** A part providing a defined degree of protection against contact with live parts, from any usual direction.

**Basic protection** Protection against electric shock under fault-free conditions.

**Circuit protective conductor** A protective conductor connecting exposed conductive parts of equipment to the main earthing terminal.

**Class II equipment** Equipment in which protection against electric shock does not rely on basic insulation only, but in which additional safety precautions such as supplementary insulation are provided. There is no provision for the connection of exposed metalwork of the equipment to a protective conductor, and no reliance upon precautions to be taken in the fixed wiring of the installation.

**Design current** The magnitude of the current intended to be carried by a circuit in normal service.

**Enclosure** A part providing an appropriate degree of protection of equipment against certain external influences and a defined degree of protection against contact with live parts from any direction.

**Exposed conductive part** A conductive part of equipment which can be touched and which is not a live part but which may become live under fault conditions.

**External influence** Any influence external to an electrical installation which affects the design and safe operation of that installation.

**Extraneous conductive part** A conductive part liable to introduce a potential, generally earth potential, and not forming part of the electrical installation.

**Fault current** A current resulting from a fault.

**Fault Protection** Protection against electric shock under single fault conditions.

**Insulation** Suitable non-conductive material enclosing, surrounding or supporting a conductor.

**Isolation** Cutting off an electrical installation, a circuit or an item of equipment from every source of electrical energy.

**Live part** A conductor or conductive part intended to be energized in normal use, including a neutral conductor but, by convention, not a PEN conductor.

**Obstacle** A part preventing unintentional contact with live parts but not preventing deliberate contact.

**Overcurrent** A current exceeding the rated value. For conductors the rated value is the current-carrying capacity.

**Overload** An overcurrent occurring in a circuit which is electrically sound.

**Residual current device (RCD)** An electromechanical switching device or association of devices intended to cause the opening of the contacts when the residual current attains a given value under specified conditions.

**Short-circuit current** An overcurrent resulting from a fault of negligible impedance between live conductors having a difference of potential under normal operating conditions.

**Skilled person** A person with technical knowledge or sufficient experience to enable him to avoid the dangers which electricity may create.

## WHAT IS PROTECTION?

The meaning of the word 'protection', as used in the electrical industry, is no different to that in everyday use. People protect themselves against personal or financial loss by means of insurance and from injury or discomfort by the use of the correct protective clothing. They further protect their property by the installation of security measures such as locks and/or alarm systems. In the same way, electrical systems need:

1. to be protected against mechanical damage, the effects of the environment and electrical overcurrents; and
2. to be installed in such a fashion that persons and/or livestock are protected from the dangers that such an electrical installation may create.

Let us now look at these protective measures in more detail.

### **Protection against mechanical damage**

The word 'mechanical' is somewhat misleading in that most of us associate it with machinery of some sort. In fact, a serious electrical overcurrent left uninterrupted for too long can cause distortion of conductors and degradation of insulation; both of these effects are considered to be mechanical damage.

However, let us start by considering the ways of preventing mechanical damage by physical impact and the like.

### **Cable construction**

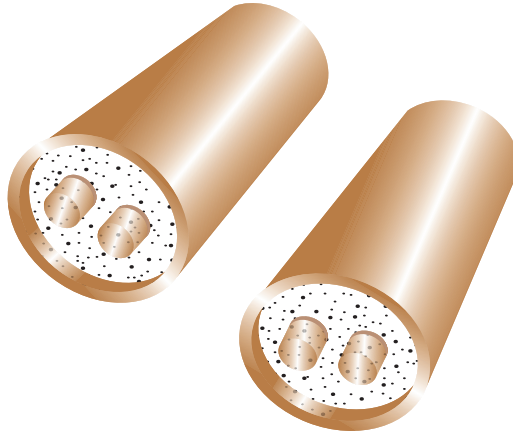
A cable comprises one or more conductors each covered with an insulating material. This insulation provides protection from shock by contact with live parts and prevents the passage of leakage currents between conductors.

Clearly, insulation is very important and in itself should be protected from damage. This may be achieved by covering the insulated conductors with a protective sheathing during manufacture, or by enclosing them in conduit or trunking at the installation stage.

The type of sheathing chosen and/or the installation method will depend on the environment in which the cable is to be installed. For example, metal conduit with thermoplastic (PVC) singles or mineral-insulated (MI) cable would be used in preference to PVC-sheathed cable clipped direct, in an industrial environment. Figure 3.1 shows the effect of physical impact on MI cable.

### **Protection against corrosion**

Mechanical damage to cable sheaths and metalwork of wiring systems can occur through corrosion, and hence care must be



**FIGURE 3.1** MI cable. On impact, all parts including the conductors are flattened, and a proportionate thickness of insulation remains between conductors, and conductors and sheath, without impairing the performance of the cable at normal working voltages.

taken to choose corrosion-resistant materials and to avoid contact between dissimilar metals in damp situations.

### Protection against thermal effects

This is the subject of Chapter 42 of the IEE Regulations. Basically, it requires common-sense decisions regarding the placing of fixed equipment, such that surrounding materials are not at risk from damage by heat.

Added to these requirements is the need to protect persons from burns by guarding parts of equipment liable to exceed temperatures listed in Table 42.1 of the Regulations.

### Polyvinyl chloride

PVC is a thermoplastic polymer widely used in electrical installation work for cable insulation, conduit and trunking. General-purpose PVC is manufactured to the British Standard BS 6746.

PVC in its raw state is a white powder; it is only after the addition of plasticizers and stabilizers that it acquires the form that we are familiar with.

### **Degradation**

All PVC polymers are degraded or reduced in quality by heat and light. Special stabilizers added during manufacture help to retard this degradation at high temperatures. However, it is recommended that PVC-sheathed cables or thermoplastic fittings for luminaires (light fittings) should not be installed where the temperature is likely to rise above 60°C. Cables insulated with high-temperature PVC (up to 80°C) should be used for drops to lampholders and entries into batten-holders. PVC conduit and trunking should not be used in temperatures above 60°C.

### **Embrittlement and cracking**

PVC exposed to low temperatures becomes brittle and will easily crack if stressed. Although both rigid and flexible, PVC used in cables and conduit can reach as low as 5°C without becoming brittle; it is recommended that general-purpose PVC-insulated cables should not be installed in areas where the temperature is likely to be consistently below 0°C, and that PVC-insulated cable should not be handled unless the ambient temperature is above 0°C and unless the cable temperature has been above 0°C for at least 24 hours.

Where rigid PVC conduit is to be installed in areas where the ambient temperature is below -5°C but not lower than -25°C, type B conduit manufactured to BS 4607 should be used.

When PVC-insulated cables are installed in loft spaces insulated with polystyrene granules, contact between the two polymers can cause the plasticizer in the PVC to migrate to the granules. This causes the PVC to harden and, although there is no change in the electrical properties, the insulation may crack if disturbed.

## External influences

Appendix 5 of the IEE Regulations classifies external influences which may affect an installation. This classification is divided into three sections, the environment (A), how that environment is utilized (B) and construction of buildings (C). The nature of any influence within each section is also represented by a letter, and the level of influence by a number. Table 3.1 gives examples of the classification.

**Table 3.1** Examples of Classifications of External Influences.

Environment	Utilization	Building
Water	Capability	Materials
<b>AD6</b> Waves	<b>BA3</b> Handicapped	<b>CA1</b> Non-combustible

With external influences included on drawings and in specifications, installations and materials used can be designed accordingly.

## Protection against ingress of solid objects, liquid and impact

In order to protect equipment from damage by foreign bodies, liquid or impact and also to prevent persons from coming into contact with live or moving parts, such equipment is housed inside enclosures or cable management systems such as conduit, trunking ducts, etc.

The degree of protection offered by such an enclosure is the subject of BS EN 60529 and BS EN 62262, commonly known as the IP and IK codes, parts of which are as shown in the accompanying tables. It will be seen from the IP table that, for instance, an enclosure to IP56 is dustproof and waterproof (Tables 3.2 and 3.3).

The most commonly quoted IP codes in the Regulations are IPXXB and IP2X (the X denotes that no protection is specified, *not* that no protection exists).

**Table 3.2** IP Codes.


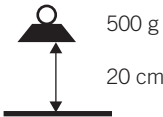
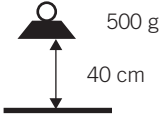
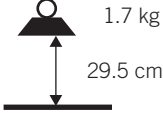
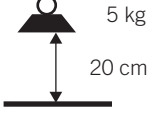
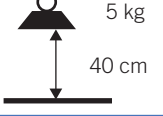
*First numeral: Mechanical protection*

0. No protection of persons against contact with live or moving parts inside the enclosure. No protection of equipment against ingress of solid foreign bodies.
1. Protection against accidental or inadvertent contact with live or moving parts inside the enclosure by a large surface of the human body, for example a hand, not for protection against deliberate access to such parts. Protection against ingress of large solid foreign bodies.
2. Protection against contact with live or moving parts inside the enclosure by fingers. Protection against ingress of medium-sized solid foreign bodies.
3. Protection against contact with live or moving parts inside the enclosure by tools, wires or such objects of thickness greater than 2.5 mm. Protection against ingress of small foreign bodies.
4. Protection against contact with live or moving parts inside the enclosure by tools, wires or such objects of thickness greater than 1 mm. Protection against ingress of small foreign bodies.
5. Complete protection against contact with live or moving parts inside the enclosures. Protection against harmful deposits of dust. The ingress of dust is not totally prevented, but dust cannot enter in an amount sufficient to interfere with satisfactory operation of the equipment enclosed.
6. Complete protection against contact with live or moving parts inside the enclosures. Protection against ingress of dust.

*Second numeral: Liquid protection*

0. No protection.
  1. Protection against drops of condensed water. Drops of condensed water falling on the enclosure shall have no effect.
  2. Protection against drops of liquid. Drops of falling liquid shall have no harmful effect when the enclosure is tilted at any angle up to 15° from the vertical.
  3. Protection against rain. Water falling in rain at an angle equal to or smaller than 60° with respect to the vertical shall have no harmful effect.
  4. Protection against splashing. Liquid splashed from any direction shall have no harmful effect.
  5. Protection against water jets. Water projected by a nozzle from any direction under stated conditions shall have no harmful effect.
  6. Protection against conditions on ships' decks (deck with watertight equipment). Water from heavy seas shall not enter the enclosures under prescribed conditions.
  7. Protection against immersion in water. It must not be possible for water to enter the enclosure under stated conditions of pressure and time.
  8. Protection against indefinite immersion in water under specified pressure. It must not be possible for water to enter the enclosure.
  - X Indicates no *specified* protections.
-

**Table 3.3** IK Codes – Protection Against Mechanical Impact.

Code		
00		No protection
01 to 05		Impact < 1 joule
06		Impact 1 joule
07		Impact 2 joules
08		Impact 5 joules
09		Impact 10 joules
10		Impact 20 joules

Hence, IP2X means that an enclosure can withstand the ingress of medium-sized solid foreign bodies (12.5 mm diameter), and a jointed test finger, known affectionately as the British Standard finger! IPXXB denotes protection against the test finger only.

For accessible horizontal top surfaces of enclosures the IP codes are IPXXD and IP4X. This indicates protection against small foreign bodies and a 1 mm diameter test wire. IPXXD is the 1 mm diameter wire only.

IEE Regulations Section 522 give details of the types of equipment, cables, enclosure, etc. that may be selected for certain environmental conditions, e.g. an enclosure housing equipment in an AD8 environment (under water) would need to be to IPX8.

### **PROTECTION AGAINST ELECTRIC SHOCK (IEE REGULATIONS CHAPTER 41)**

There are two ways of receiving an electric shock: by contact with intentionally live parts, and by contact with conductive parts made live due to a fault. It is obvious that we need to provide protection against both of these conditions.

#### **Basic protection (IEE Regulations Sections 410 to 417)**

Clearly, it is not satisfactory to have live parts accessible to touch by persons or livestock. The IEE Regulations recommend five ways of minimizing this danger:

1. By covering the live part or parts with insulation which can only be removed by destruction, e.g. cable insulation.
2. By placing the live part or parts behind a barrier or inside an enclosure providing protection to at least IPXXB or IP2X.  
In most cases, during the life of an installation it becomes necessary to open an enclosure or remove a barrier. Under these circumstances, this action should only be possible by the use of a key or tool, e.g. by using a screwdriver to open a junction box. Alternatively, access should only be gained

after the supply to the live parts has been disconnected, e.g. by isolation on the front of a control panel where the cover cannot be removed until the isolator is in the 'off' position. An intermediate barrier of at least IP2X or IPXXB will give protection when an enclosure is opened: a good example of this is the barrier inside distribution fuseboards, preventing accidental contact with incoming live feeds.

3. By placing obstacles to prevent unintentional approach to or contact with live parts. This method must only be used where skilled persons are working.
4. By placing out of arm's reach: for example, the high level of the bare conductors of travelling cranes.
5. By using an RCD as additional protection. Whilst not permitted as the sole means of protection, this is considered to reduce the risk associated with contact with live parts, provided that one of the other methods just mentioned is applied, and that the RCD has a rated operating current  $I_{\Delta n}$  of not more than 30 mA and an operating time not exceeding 40 ms at 5 times  $I_n$ , i.e. 150 mA.

### **Fault protection (IEE Regulations Sections 410 to 417)**

Protective earthing, protective equipotential bonding and automatic disconnection in the event of a fault have already been discussed in Chapter 2. The other methods are as follows.

#### **Protection by automatic disconnection of supply (IEE Regulations Section 411)**

This measure is a combination of basic and fault protection.

#### **Double or reinforced insulation**

Often referred to as Class II equipment, this is typical of modern appliances where there is no provision for the connection of a cpc.

This does not mean that there should be no exposed conductive parts and that the casing of equipment should be of an insulating material; it simply indicates that live parts are so well insulated that faults from live to conductive parts cannot occur.

### **Non-conducting location (IEE Regulations Section 418)**

This is basically an area in which the floor, walls and ceiling are all insulated. Within such an area there must be no protective conductors, and socket outlets will have no earthing connections.

It must not be possible simultaneously to touch two exposed conductive parts, or an exposed conductive part and an extraneous conductive part. This requirement clearly prevents shock current passing through a person in the event of an earth fault, and the insulated construction prevents shock current passing to earth.

### **Earth-free local equipotential bonding (IEE Regulations Section 418)**

This is, in essence, a Faraday cage, where all metal is bonded together but not to earth. Obviously great care must be taken when entering such a zone in order to avoid differences in potential between inside and outside.

The areas mentioned in this and the previous method are very uncommon. Where they do exist, they should be under constant supervision to ensure that no additions or alterations can lessen the protection intended.

### **Electrical separation (IEE Regulations Section 418)**

This method relies on a supply from a safety source such as an isolating transformer to BS EN 60742 which has no earth connection

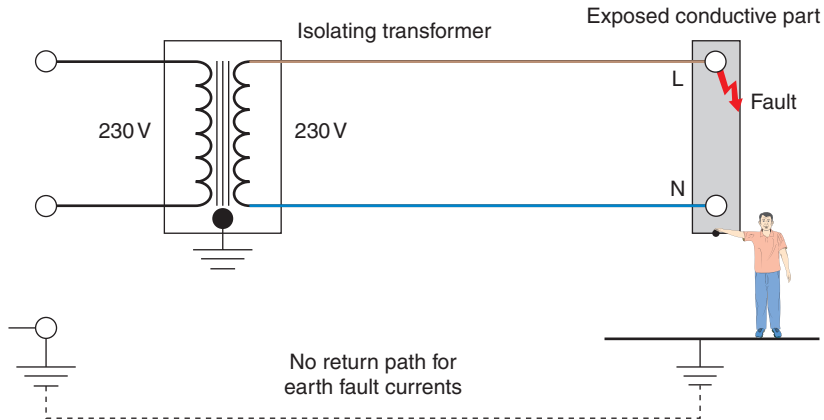


FIGURE 3.2

on the secondary side. In the event of a circuit that is supplied from a source developing a live fault to an exposed conductive part, there would be no path for shock current to flow: see Figure 3.2.

Once again, great care must be taken to maintain the integrity of this type of system, as an inadvertent connection to earth, or interconnection with other circuits, would render the protection useless.

### Exemptions (IEE Regulations 410.3.9)

As with most sets of rules and regulations, there are certain areas which are exempt from the requirements. These are listed quite clearly in IEE Regulations 410.3.9, and there is no point in repeating them all here. However, one example is the dispensing of the need to earth exposed conductive parts such as small fixings, screws and rivets, provided that they cannot be touched or gripped by a major part of the human body (not less than 50 mm by 50 mm), and that it is difficult to make and maintain an earth connection.

## **SELV or PELV**

This is simply extra low voltage (less than 50V AC) derived from a safety source such as a Class II safety isolating transformer to BS EN 61558-2-6; or a motor generator which has the same degree of isolation as the transformer; or a battery or diesel generator; or an electronic device such as a signal generator.

Live or exposed conductive parts of separated extra low voltage (SELV) circuits should not be connected to earth, or protective conductors of other circuits, and SELV or PELV circuit conductors should ideally be kept separate from those of other circuits. If this is not possible, then the SELV conductors should be insulated to the highest voltage present.

Obviously, plugs and sockets of SELV or PELV circuits should not be interchangeable with those of other circuits.

SELV or PELV circuits supplying socket outlets are mainly used for hand lamps or soldering irons, for example, in schools and colleges. Perhaps a more common example of an SELV or PELV circuit is a domestic bell installation, where the transformer is to BS EN 60742. Note that bell wire is usually only suitable for 50–60V, which means that it should not be run together with circuit cables of higher voltages.

## **Reduced low-voltage systems (IEE Regulations Section 411.8)**

The Health and Safety Executive accepts that a voltage of 65V to earth, three-phase, or 55V to earth, single-phase, will give protection against severe electric shock. They therefore recommend that portable tools used on construction sites, etc. be fed from a 110V centre-tapped transformer. Figure 3.3 shows how 55V is derived. Earth fault loop impedance values for these systems may be taken from Table 41.6 of the Regulations.

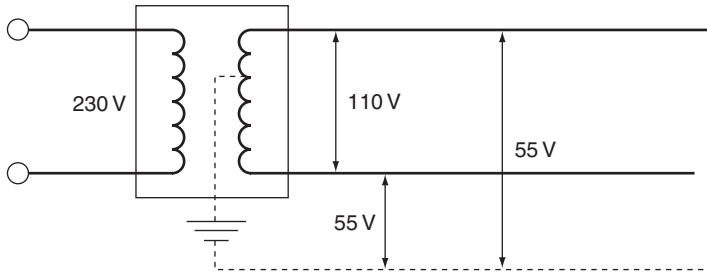


FIGURE 3.3

## PROTECTION AGAINST OVERCURRENT (IEE REGULATIONS CHAPTER 43 AND DEFINITIONS)

An overcurrent is a current greater than the rated current of a circuit. It may occur in two ways:

1. As an overload current; or
2. As a fault current, which may be sub divided into:
  - (a) A short-circuit current and
  - (b) An earth fault current.

These conditions need to be protected against in order to avoid damage to circuit conductors and equipment. In practice, fuses and circuit breakers will fulfil both of these needs.

### Overloads

Overloads are overcurrents occurring in healthy circuits. They may be caused, for example, by faulty appliances or by surges due to motors starting or by plugging in too many appliances in a socket outlet circuit.

### Short circuits and earth faults

A short-circuit current is the current that will flow when a 'dead short' occurs between live conductors (line-to-neutral for single-phase; line-to-line for three-phase). Earth fault current flows when

there is a short between a line conductor and earth. Prospective short-circuit current (PSCC) and prospective earth fault current (PEFC) are collectively known as prospective fault current (PFC). The term is usually used to signify the value of fault current at fuse or circuit breaker positions.

PFC is of great importance. However, before discussing it or any other overcurrent further, it is perhaps wise to refresh our memories with regard to fuses and circuit breakers and their characteristics.

### **Fuses and circuit breakers**

As we all know, a fuse is the weak link in a circuit which will break when too much current flows, thus protecting the circuit conductors from damage.

There are many different types and sizes of fuse, all designed to perform a certain function. The IEE Regulations refer to only four of these: BS 3036, BS 88, BS 1361 and BS 1362 fuses. It is perhaps sensible to include, at this point, circuit breakers to BS 3871 and BS EN 60898.

### **Breaking capacity of fuses and circuit breakers (IEE Regulations Section 434)**

When a fault occurs, the current may, for a fraction of a second, reach hundreds or even thousands of amperes. The protective device must be able to break and, in the case of circuit breakers, make such a current without damage to its surroundings by arcing, overheating or the scattering of hot particles.

Tables 3.4 and 3.5 indicate the performance of circuit breakers and the more commonly used British Standard fuse links.

Although all reference to BS 3871 MCBs have been removed from BS 7671, they are still used and therefore worthy of mention.

**Table 3.4**

Circuit Breakers	Breaking Capacity (kA)	
BS 3871 Types 1, 2, 3, etc.	1	(M1)
	1.5	(M1.5)
	3	(M3)
	4.5	(M4.5)
	6	(M6)
	9	(M9)
BS EN 60898 Types B, C, D	$I_{cn}$ 1.5	$I_{cs}$ 1.5
	3	3
	6	6
	10	7.5
	15	7.5
	25	10

$I_{cn}$  is the rated ultimate breaking capacity.  $I_{cs}$  is the maximum breaking capacity operation after which the breaker may still be used without loss of performance.

## Fuse and circuit breaker operation

Let us consider a protective device rated at, say, 10A. This value of current can be carried indefinitely by the device, and is known as its nominal setting  $I_n$ . The value of the current which will cause operation of the device,  $I_2$ , will be larger than  $I_n$ , and will be dependent on the device's *fusing factor*. This is a figure which, when multiplied by the nominal setting  $I_n$ , will indicate the value of operating current  $I_2$ .

For fuses to BS 88 and BS 1361 and circuit breakers to BS 3871 this fusing factor is approximately 1.45; hence our 10A device would not operate until the current reached  $1.45 \times 10 = 14.5$ A.

The IEE Regulations require coordination between conductors and protection when an overload occurs, such that:

1. The nominal setting of the device  $I_n$  is greater than or equal to the design current of the circuit  $I_b$  ( $I_n \geq I_b$ ).

**Table 3.5** British Standards for Fuse Links.

Standard		Current Rating	Voltage Rating
1	BS 2950	Range 0.05–25 A	Range 1000V (0.05 A) to 32 V (25 A) AC and DC
2	BS 646	1, 2, 3 and 5 A	Up to 250V AC and DC
3	BS 1362 cartridge	1, 2, 3, 5, 7, 10 and 13 A	Up to 250V AC
4	BS 1361 HRC cut-out fuses	5, 15, 20, 30, 45 and 60 A	Up to 250V AC
5	BS 88 motors	Four ranges, 2–1200 A	Up to 660V, but normally 250 or 415V AC and 250 or 500V DC
6	BS 2692	Main range from 5 to 200 A; 0.5 to 3 A for voltage transformer protective fuses	Range from 2.2 to 132 kV
7	BS 3036 rewirable	5, 15, 20, 30, 45, 60, 100, 150 and 200 A	Up to 250V to earth
8	BS 4265	500 mA to 6.3 A, 32 mA to 2 A	Up to 250V AC

Breaking Capacity	Notes
1. Two or three times current rating	Cartridge fuse links for telecommunication and light electrical apparatus. Very low breaking capacity
2. 1000 A	Cartridge fuse intended for fused plugs and adapters to BS 546: 'round-pin' plugs
3. 6000 A	Cartridge fuse primarily intended for BS 1363: 'flat-pin' plugs
4. 16500 A, 33000 A	Cartridge fuse intended for use in domestic consumer units. The dimensions prevent interchangeability of fuse links which are not of the same current rating
5. Ranges from 10000 to 80000 A in four AC and three DC categories	Part 1 of Standard gives performance and dimensions of cartridge fuse links, whilst Part 2 gives performance and requirements of fuse carriers and fuse bases designed to accommodate fuse links complying with Part 1
6. Ranges from 25 to 750 MVA (main range), 50 to 2500 MVA (VT fuses)	Fuses for AC power circuits above 660 V
7. Ranges from 1000 to 12000 A	Semi-enclosed fuses (the element is a replacement wire) for AC and DC circuits
8. 1500 A (high breaking capacity), 35 A (low breaking capacity)	Miniature fuse links for protection of appliances of up to 250 V (metric standard)

2. The nominal setting  $I_n$  is less than or equal to the lowest current-carrying capacity  $I_z$  of any of the circuit conductors ( $I_n \leq I_z$ ).
3. The operating current of the device  $I_2$  is less than or equal to  $1.45 I_z$  ( $I_2 \leq 1.45 I_z$ ).

So, for our 10A device, if the cable is rated at 10A then condition 2 is satisfied. Since the fusing factor is 1.45, condition 3 is also satisfied:  $I_2 = I_n \times 1.45 = 10 \times 1.45$ , which is also 1.45 times the 10A cable rating.

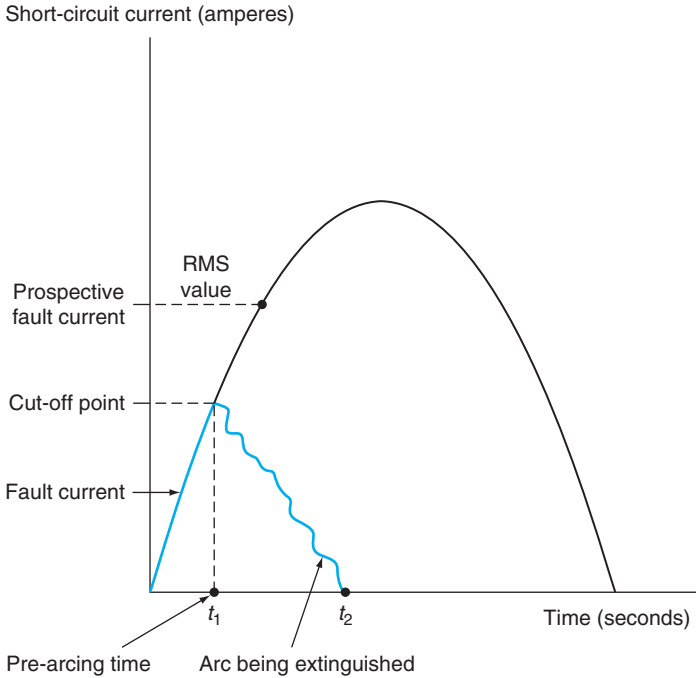
The problem arises when a BS 3036 semi-enclosed rewirable fuse is used, as it may have a fusing factor of as much as 2. In order to comply with condition 3,  $I_n$  should be less than or equal to  $0.725 I_z$ .

This figure is derived from  $1.45/2 = 0.725$ . For example, if a cable is rated at 10A, then  $I_n$  for a BS 3036 should be  $0.725 \times 10 = 7.25$ A. As the fusing factor is 2, the operating current  $I_2 = 2 \times 7.25 = 14.5$ , which conforms with condition 3, i.e.  $I_2 \leq 1.45 \times 10 = 14.5$ .

All of these foregoing requirements ensure that conductor insulation is undamaged when an overload occurs.

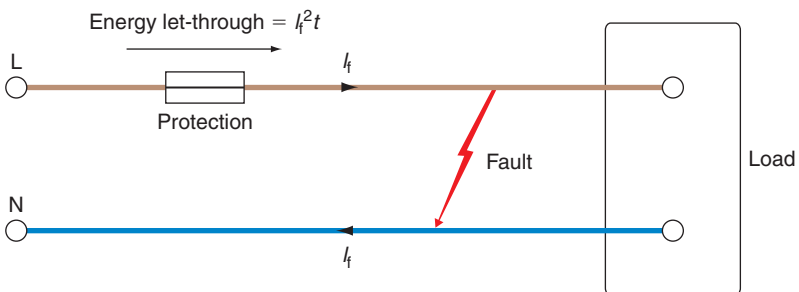
Under fault conditions it is the conductor itself that is susceptible to damage and must be protected. Figure 3.4 shows one half-cycle of short-circuit current if there were no protection. The RMS value ( $0.7071 \times$  maximum value) is called the PFC. The cut-off point is where the fault current is interrupted and an arc is formed; the time  $t_1$  taken to reach this point is called the pre-arcing time. After the current has been cut off, it falls to zero as the arc is being extinguished. The time  $t_2$  is the total time taken to disconnect the fault.

During the time  $t_1$ , the protective device is allowing energy to pass through to the load side of the circuit. This energy is known as the



**FIGURE 3.4** Let-through energy.

pre-arcing let-through energy and is given by  $I^2t_1$ , where  $I$  is the fault current. The total let-through energy from start to disconnection of the fault is given by  $I^2t_2$  (see Figure 3.5 and Table 3.6).



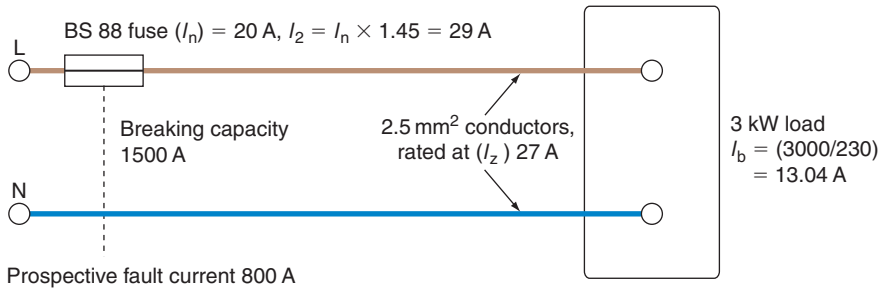
**FIGURE 3.5** Let-through energy.

For faults of up to 5 s duration, the amount of heat energy that cable can withstand is given by  $k^2s^2$ , where  $s$  is the cross-sectional area of the conductor and  $k$  is a factor dependent on the conduct or material. Hence, the let-through energy should not exceed  $k^2s^2$ , i.e.  $I^2t = k^2s^2$ . If we transpose this formula for  $t$ , we get  $t = k^2s^2/I^2$ , which is the maximum disconnection time in seconds.

Remember that these requirements refer to fault currents only. If, in fact, the protective device has been selected to protect against overloads and has a breaking capacity not less than the PFC at the point of installation, it will also protect against fault currents. However, if there is any doubt the formula should be used.

For example, in Figure 3.6, if  $I_n$  has been selected for overload protection, the questions to be asked are as follows:

1. Is  $I_n \geq I_b$ ?      Yes
2. Is  $I_n \leq I_z$ ?      Yes
3. Is  $I_2 \geq 1.45I_z$ ?    Yes



**FIGURE 3.6**

Then, if the device has a rated breaking capacity not less than the PFC, it can be considered to give protection against fault current also.

When an installation is being designed, the PFC at every relevant point must be determined, by either calculation or measurement. The value will decrease as we move farther away from the intake position (resistance increases with length). Thus, if the breaking

**Table 3.6**  $I^2t$  characteristics: 2–800A Fuse Links. Discrimination is Achieved if the Total  $I^2t$  of the Minor Fuse Does Not Exceed the Pre-arcing  $I^2t$  of the Major Fuse.

Rating (A)	$I^2t$ Pre-arcing	$I^2t$ Total at 400V
2	0.9	17
4	4	12
6	16	59
10	56	170
16	190	580
20	310	810
25	630	1700
32	1200	2800
40	2000	6000
50	3600	11000
63	6500	14000
80	13000	36000
100	24 000	66000
125	34 000	120000
160	80 000	260000
200	140 000	400000
250	230 000	560000
315	360000	920000
350	550000	1 300000
400	800 000	2 300000
450	700000	1 400000
500	900 000	1 800000
630	2 200000	4 500000
700	2 500 000	5 000000
800	4 300 000	10 000000

capacity of the lowest rated fuse in the installation is greater than the PFC at the origin of the supply, there is no need to determine the value except at the origin.

### Discrimination (IEE Regulation 536.2)

When we discriminate, we indicate our preference over other choices: this house rather than that house, for example. With protection we have to ensure that the correct device operates when

there is a fault. Hence, a 13A BS 1362 plug fuse should operate before the main circuit fuse. Logically, protection starts at the origin of an installation with a large device and progresses down the chain with smaller and smaller sizes.

Simply because protective devices have different ratings, it cannot be assumed that discrimination is achieved. This is especially the case where a mixture of different types of device is used. However, as a general rule a 2:1 ratio with the lower-rated devices will be satisfactory. The table on page 67 shows how fuse links may be chosen to ensure discrimination.

Fuses will give discrimination if the figure in column 3 does not exceed the figure in column 2. Hence:

- a 2A fuse will discriminate with a 4A fuse
- a 4A fuse will discriminate with a 6A fuse
- a 6A fuse will *not* discriminate with a 10A fuse
- a 10A fuse will discriminate with a 16A fuse.

All other fuses will *not* discriminate with the next highest fuse, and in some cases several sizes higher are needed, e.g. a 250A fuse will only discriminate with a 400A fuse.

### **Position of protective devices (IEE Regulations 433.2 and 434.2)**

When there is a reduction in the current-carrying capacity of a conductor, a protective device is required. There are, however, some exceptions to this requirement; these are listed quite clearly in Sections 433 and 434 of the IEE Regulations. As an example, protection is not needed in a ceiling rose where the cable size changes from 1.0 mm<sup>2</sup> to, say, 0.5 mm<sup>2</sup> for the lampholder flex. This is permitted as it is not expected that lamps will cause overloads.

## **PROTECTION AGAINST OVERVOLTAGE (IEE REGULATIONS SECTION 443)**

This chapter deals with the requirements of an electrical installation to withstand overvoltages caused by lightning or switching surges. It is unlikely that installations in the UK will be affected by the requirements of this section as the number of thunderstorm days per year is not likely to exceed 25.

## **PROTECTION AGAINST UNDERVOLTAGE (IEE REGULATIONS SECTION 445)**

From the point of view of danger in the event of a drop or loss of voltage, the protection should prevent automatic restarting of machinery, etc. In fact, such protection is an integral part of motor starters in the form of the control circuit.

This page intentionally left blank

# Isolation Switching and Control

## DEFINITIONS USED IN THIS CHAPTER

**Emergency switching** Rapid cutting off of electrical energy to remove any hazard to persons, livestock or property which may occur unexpectedly.

**Isolation** Cutting off an electrical installation, a circuit or an item of equipment from every source of electrical energy.

**Mechanical maintenance** The replacement, refurbishment or cleaning of lamps and non-electrical parts of equipment, plant and machinery.

**Switch** A mechanical switching device capable of making, carrying and breaking current under normal circuit conditions, which may include specified overload conditions, and also of carrying, for a specified time, currents under specified abnormal conditions such as those of short circuit.

## ISOLATION AND SWITCHING (IEE REGULATIONS SECTION 537)

All installations, whether they be the whole or part, must have a means of isolation and switching for various reasons. These are:

1. To remove possible dangers associated with the installation/operation/testing of electrical installations.
2. To provide a means of functional switching and control.

The IEE Regulations make reference to:

1. **Switching off for mechanical maintenance** The devices for this function should be manually operated and preferably located in the main supply circuit.
2. **Emergency switching** The devices for this function should preferably be hand operated and be capable of interrupting the full load of the circuit concerned.
3. **Functional switching** This is simply switching an item on or off to control its function, e.g. a light switch.
4. **Firefighters' switches** Clearly for the function of isolation in the event of a fire. They should be coloured red and be installed no more than 2.75 m above the ground with the OFF position at the top.

The following chart (Table 4.1) shows type and uses of various devices used for isolation and switching.

**Table 4.1** Selection of Generally Used Devices.

Device	Isolation	Emergency	Function
Circuit breakers	Yes	Yes	Yes
RCDs	Yes	Yes	Yes
Isolating switches	Yes	Yes	Yes
Plugs and socket outlets	Yes	No	Yes
Ditto but over 32 A	Yes	No	No
Switched fused connection unit	Yes	Yes	Yes
Unswitched fused connection unit	Yes	No	No
Plug fuses	Yes	No	No
Cooker units	Yes	Yes	Yes

## Control

### *Motor control*

This is usually part of the motor starter and most importantly must prevent automatic restarting after loss of supply and subsequent restoration, i.e undervoltage protection.

# Circuit Design

## DEFINITIONS USED IN THIS CHAPTER

**Ambient temperature** The temperature of the air or other medium where the equipment is to be used.

**Circuit protective conductor** A protective conductor connecting exposed conductive parts of equipment to the main earthing terminal.

**Current-carrying capacity** The maximum current which can be carried by a conductor under specified conditions without its steady state temperature exceeding a specified value.

**Design current** The magnitude of the current intended to be carried by a circuit in normal service.

**Earthing conductor** A protective conductor connecting a main earthing terminal of an installation to an earth electrode or other means of earthing.

**Fault current** An overcurrent resulting from a fault of negligible impedance between live conductors (short-circuit current) or between a line conductor and earth (earth fault current).

**Overcurrent** A current exceeding the rated value. For conductors the rated value is the current-carrying capacity.

## DESIGN PROCEDURE

The requirements of IEE Regulations make it clear that circuits must be designed and the design data made readily available. In fact, this has always been the case with previous editions of the Regulations, but it has not been so clearly indicated.

How then do we begin to design? Clearly, plunging into calculations of cable size is of little value unless the type of cable and its method of installation are known. This, in turn, will depend on the installation's environment. At the same time, we would need to know whether the supply was single- or three-phase, the type of earthing arrangements, and so on. Here then is our starting point and it is referred to in the Regulations, Chapter 3, as 'Assessment of general characteristics'.

Having ascertained all the necessary details, we can decide on an installation method, the type of cable, and how we will protect against electric shock and overcurrents. We would now be ready to begin the calculation part of the design procedure.

Basically there are eight stages in such a procedure. These are the same whatever the type of installation, be it a cooker circuit or a distribution cable feeding a distribution board in a factory. Here, then, are the eight basic steps in a simplified form:

1. Determine the design current  $I_b$ .
2. Select the rating of the protection  $I_n$ .
3. Select the relevant rating factors (CFs).
4. Divide  $I_n$  by the relevant CFs to give tabulated cable current-carrying capacity  $I_t$ .
5. Choose a cable size, to suit  $I_t$ .
6. Check the voltage drop.
7. Check for shock risk constraints.
8. Check for thermal constraints.

Let us now examine each stage in detail.

Add to this the requirement to select conduit and trunking sizes and we have a complete design.

## DESIGN CURRENT

In many instances the design current  $I_b$  is quoted by the manufacturer, but there are times when it has to be calculated. In that case there are two formulae involved, one for single-phase and one for three-phase:

Single-phase:

$$I_b = \frac{P \text{ (watts)}}{V} \text{ (} V \text{ usually } 230 \text{ V)}$$

Three-phase:

$$I_b = \frac{P \text{ (watts)}}{\sqrt{3} \times V_L} \text{ (} V_L \text{ usually } 400 \text{ V)}$$

Current is in amperes, and power  $P$  in watts.

If an item of equipment has a power factor ( $PF$ ) and/or has moving parts, efficiency ( $eff$ ) will have to be taken into account.

Hence:

Single-phase:

$$I_b = \frac{P \text{ (watts)} \times 100}{V \times PF \times eff}$$

Three-phase:

$$I_b = \frac{P \times 100}{\sqrt{3} \times V_L \times PF \times eff}$$

## NOMINAL SETTING OF PROTECTION

Having determined  $I_b$  we must now select the nominal setting of the protection such that  $I_n \geq I_b$ . This value may be taken from IEE Regulations, Tables 41.2, 41.3 or 41.4 or from manufacturers' charts. The choice of fuse or CB type is also important and may have to be changed if cable sizes or loop impedances are too high. These details will be discussed later.

### Rating factors

When a cable carries its full load current it can become warm. This is no problem unless its temperature rises further due to other influences, in which case the insulation could be damaged by overheating. These other influences are: high ambient temperature; cables grouped together closely; uncleared overcurrents; and contact with thermal insulation.

For each of these conditions there is a rating factor (CF) which will respectively be called  $C_a$ ,  $C_g$ ,  $C_c$  and  $C_i$ , and which de-rates cable current-carrying capacity or conversely increases cable size.

### ***Ambient temperature $C_a$***

The cable ratings in the IEE Regulations are based on an ambient temperature of 30°C, and hence it is only above this temperature that an adverse correction is needed. Table 4B1 of the Regulations gives factors for all types of insulation.

### ***Grouping $C_g$***

When cables are grouped together they impart heat to each other. Therefore, the more cables there are the more heat they will generate, thus increasing the temperature of each cable. Table 4C1 of

the Regulations gives factors for such groups of cables or circuits. It should be noted that the figures given are for uniform groups of cables equally loaded, and hence correction may not necessarily be needed for cables grouped at the outlet of a domestic consumer unit, for example where there is a mixture of different sizes.

A typical situation where rating factors need to be applied would be in the calculation of cable sizes for a lighting system in a large factory. Here many cables of the same size and loading may be grouped together in trunking and could be expected to be fully loaded all at the same time.

### ***Protection by BS 3036 fuse and/or when the cable is underground $C_c$***

As we have already discussed in Chapter 3, because of the high fusing factor of BS 3036 fuses, the rating of the fuse  $I_n$  should be  $\leq 0.725 I_z$ .

Hence 0.725 is the rating factor to be used when BS 3036 fuses are used.

If the cable is in a duct underground or buried direct the factor is 0.9.

If both conditions exist the factor is  $0.725 \times 0.9 = 0.653$ .

### ***Thermal insulation $C_t$***

With the modern trend towards energy saving and the installation of thermal insulation, there may be a need to de-rate cables to account for heat retention.

The values of cable current-carrying capacity given in Appendix 4 of the IEE Regulations have been adjusted for situations when thermal insulation touches one side of a cable. However, if a cable is totally surrounded by thermal insulation for more than 0.5 m,

a factor of 0.5 must be applied to the tabulated clipped direct ratings. For less than 0.5m, de-rating factors (Table 52.2 of the Regulations) should be applied.

### ***Application of rating factors***

Some or all of the onerous conditions just outlined may affect a cable along its whole length or parts of it, but not all may affect it at the same time. So, consider the following:

1. If the cable in Figure 5.1 ran for the whole of its length, grouped with others of the same size in a high ambient temperature, and was totally surrounded with thermal insulation, it would seem logical to apply all the CFs, as they all affect the whole cable run. Certainly the factors for the BS 3036 fuse, grouping and thermal insulation should be used. However, it is doubtful if the ambient temperature will have any effect on the cable, as the thermal insulation, if it is efficient, will prevent heat reaching the cable. Hence, apply  $C_g$ ,  $C_c$  and  $C_i$ .
2. In Figure 5.2a the cable first runs grouped, then leaves the group and runs in high ambient temperature, and finally is enclosed in thermal insulation. We therefore have three different conditions, each affecting the cable in different areas. The BS 3036 fuse affects the whole cable run and therefore  $C_c$  must be used, but there is no need to apply all of the remaining factors as the worse one will automatically compensate for the others. The relevant factors are shown in Figure 5.2b; apply only  $C_c = 0.725$  and  $C_i = 0.5$ . If protection was *not* by BS 3036 fuse, then apply only  $C_i = 0.5$ .
3. In Figure 5.3a combination of cases 1 and 2 is considered. The effect of grouping and ambient temperature is  $0.7 \times 0.97 = 0.69$ . The factor for thermal insulation is still worse than this combination, and therefore  $C_i$  is the only one to be used.

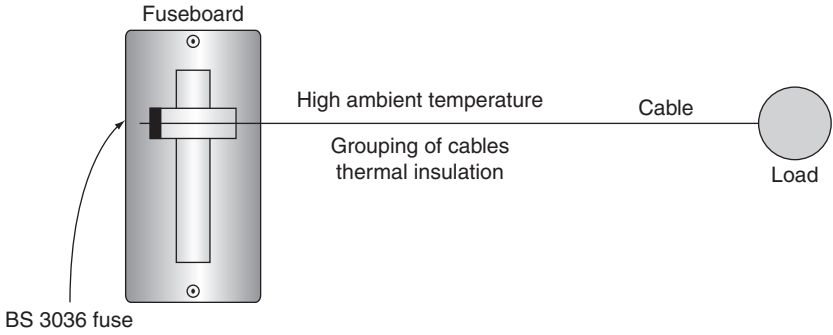


FIGURE 5.1

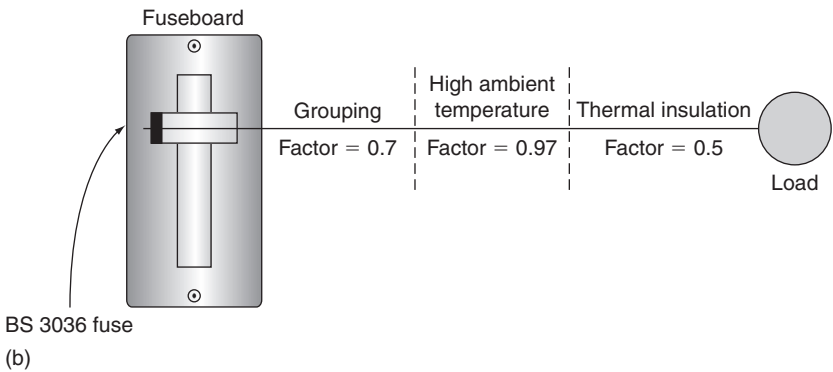
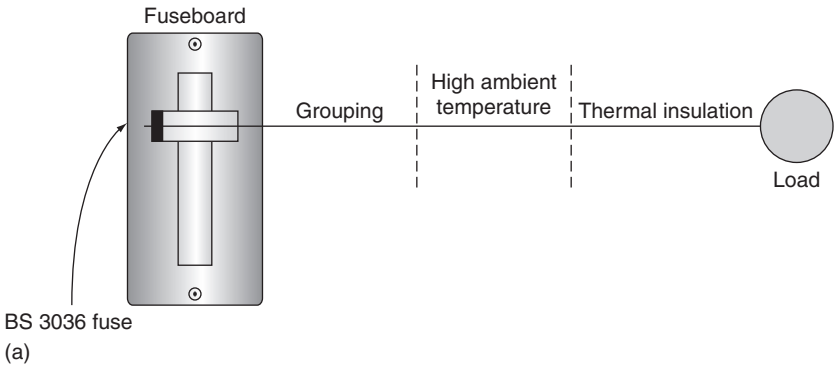
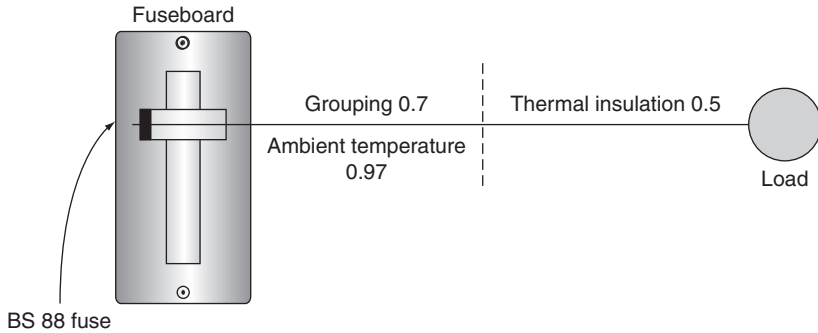


FIGURE 5.2



**FIGURE 5.3**

Having chosen the *relevant* rating factors, we now apply them to the nominal rating of the protection  $I_n$  as divisors in order to calculate the current-carrying capacity  $I_t$  of the cable.

### Tabulated current-carrying capacity

The required formula for current-carrying capacity  $I_t$  is:

$$I_t \geq I_n$$

relevant CFs

In Figure 5.4 the current-carrying capacity is given by

$$I_t \geq \frac{I_n}{C_c C_i} = \frac{30}{0.725 \times 0.5} = 82.75 \text{ A}$$

or, without the BS 3036 fuse:

$$I_t \geq \frac{30}{0.5} = 60 \text{ A}$$

In Figure 5.4,  $C_a C_i = 0.97 \times 0.5 = 0.485$ , which is worse than  $C_i$  (0.5) (Figure 5.5).

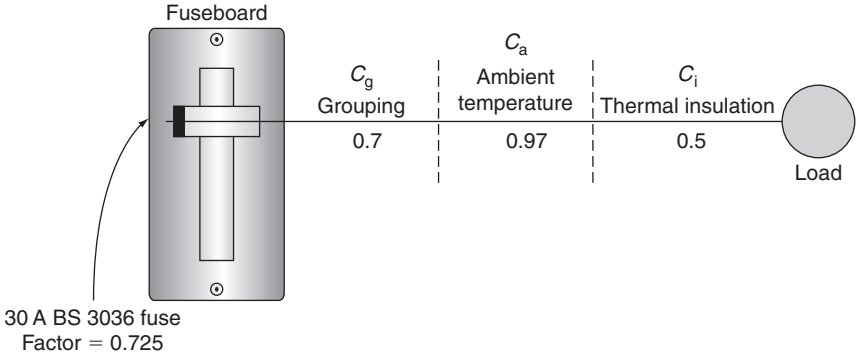


FIGURE 5.4

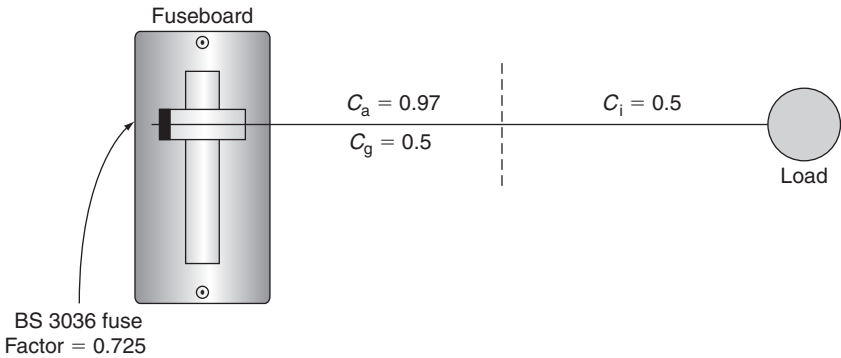


FIGURE 5.5

Hence:

$$I_t \geq \frac{I_n}{C_c C_a C_g} = \frac{30}{0.725 \times 0.485} = 85.3 \text{ A}$$

or, without the BS 3036 fuse:

$$I_t = \frac{30}{0.485} = 61.85 \text{ A}$$

Note: If the circuit is not subject to overload,  $I_n$  can be replaced by  $I_b$  so the formula becomes:

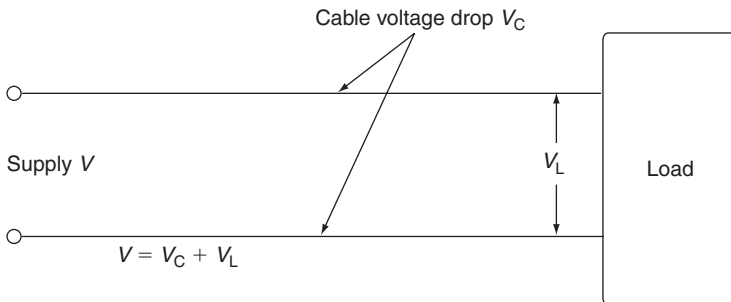
$$I_t \geq \frac{I_b}{CF_s}$$

### Choice of cable size

Having established the tabulated current-carrying capacity  $I_t$  of the cable to be used, it now remains to choose a cable to suit that value. The tables in Appendix 4 of the IEE Regulations list all the cable sizes, current-carrying capacities and voltage drops of the various types of cable. For example, for PVC-insulated singles, single-phase, in conduit, having a current-carrying capacity of 45A, the installation is by reference method B (Table 4A2), the cable table is 4D1A and the column is 4. Hence, the cable size is 10.0mm<sup>2</sup> (column 1).

### VOLTAGE DROP (IEE REGULATIONS 525 AND APPENDIX 12)

The resistance of a conductor increases as the length increases and/or the cross-sectional area decreases. Associated with an increased resistance is a drop in voltage, which means that a load at the end of a long thin cable will not have the full supply voltage available (Figure 5.6).



**FIGURE 5.6** Voltage drop.

The IEE Regulations require that the voltage drop  $V$  should not be so excessive that equipment does not function safely. They further indicate that the following percentages of the nominal voltage at the *origin* of the circuit will satisfy. This means that:

	LV Lighting (3%)	LV Power (5%)
230V single-phase	6.9 V	11.5 V
400V three-phase	12 V	20 V

For example, the voltage drop on a power circuit supplied from a 230V source by a 16.0mm<sup>2</sup> two-core copper cable 23m long, clipped direct and carrying a design current of 33A, will be:

$$\begin{aligned} V_c &= \frac{\text{mV} \times I_b \times L}{1000} \text{ (mV; from Table 4D2B)} \\ &= \frac{28 \times 33 \times 23}{1000} = 21.25 \text{ V} \end{aligned}$$

As we know that the maximum voltage drop in this instance (230V) is 11.5V, we can determine the maximum length by transposing the formula:

$$\begin{aligned} \text{maximum length} &= \frac{V_c \times 1000}{\text{mV} \times I_b} \\ &= \frac{11.5 \times 1000}{28 \times 23} = 17.8 \text{ m} \end{aligned}$$

There are other constraints, however, which may not permit such a length.

## SHOCK RISK (IEE REGULATIONS SECTION 411)

This topic has already been discussed in full in Chapter 2. To recap, however, the actual loop impedance  $Z_s$  should not exceed

those values given in Tables 41.2, 41.3 and 41.4 of the IEE Regulations. This ensures that circuits feeding final and distribution circuits will be disconnected, in the event of an earth fault, in the required time.

Remember  $Z_s = Z_e + R_1 + R_2$ .

### THERMAL CONSTRAINTS (IEE REGULATIONS SECTION 543)

The IEE Regulations require that we either select or check the size of a cpc against Table 54.7 of the Regulations, or calculate its size using an adiabatic equation.

#### Selection of cpc using Table 54.7

Table 54.7 of the Regulations simply tells us that:

1. For line conductors up to and including  $16 \text{ mm}^2$ , the cpc should be at least the same size.
2. For sizes between  $16 \text{ mm}^2$  and  $35 \text{ mm}^2$ , the cpc should be at least  $16 \text{ mm}^2$ .
3. For sizes of line conductor over  $35 \text{ mm}^2$ , the cpc should be at least half this size.

This is all very well, but for large sizes of line conductor the cpc is also large and hence costly to supply and install. Also, composite cables such as the typical twin with cpc 6242Y type have cpcs smaller than the line conductor and hence do not comply with Table 54.7.

#### Calculation of cpc using an adiabatic equation

The adiabatic equation

$$s = \frac{\sqrt{I^2 t}}{k}$$

enables us to check on a selected size of cable, or on an actual size in a multicore cable. In order to apply the equation we need first to calculate the earth fault current from:

$$I = U_0/Z_s$$

where  $U_0$  is the nominal line voltage to earth (usually 230 V) and  $Z_s$  is the actual earth fault loop impedance. Next we select a  $k$  factor from Tables 54.2 to 54.7 of the Regulations, and then determine the disconnection time  $t$  from the relevant curve.

For those unfamiliar with such curves, using them may appear a daunting task. A brief explanation may help to dispel any fears. Referring to any of the curves for fuses in Appendix 3 of the IEE Regulations, we can see that the current scale goes from 1 A to 10 000 A, and the time scale from 0.01 s to 10 000 s. One can imagine the difficulty in drawing a scale between 1 A and 10 000 A in divisions of 1 A, and so a logarithmic scale is used. This cramps the large scale into a small area. All the subdivisions between the major divisions increase in equal amounts depending on the major division boundaries; for example, all the subdivisions between 100 and 1000 are in amounts of 100 (Figure 5.7).

Figures 5.8 and 5.9 give the IEE Regulations time/current curves for BS 88 fuses. Referring to the appropriate curve for a 32 A fuse (Figure 5.9), we find that a fault current of 200 A will cause disconnection of the supply in 0.6 s.

Where a value falls between two subdivisions, for example 150 A, an estimate of its position must be made. Remember that even if the scale is not visible, it would be cramped at one end; so 150 A would not fall half-way between 100 A and 200 A (Figure 5.8).

It will be noted in Appendix 3 of the Regulations that each set of curves is accompanied by a table which indicates the current that

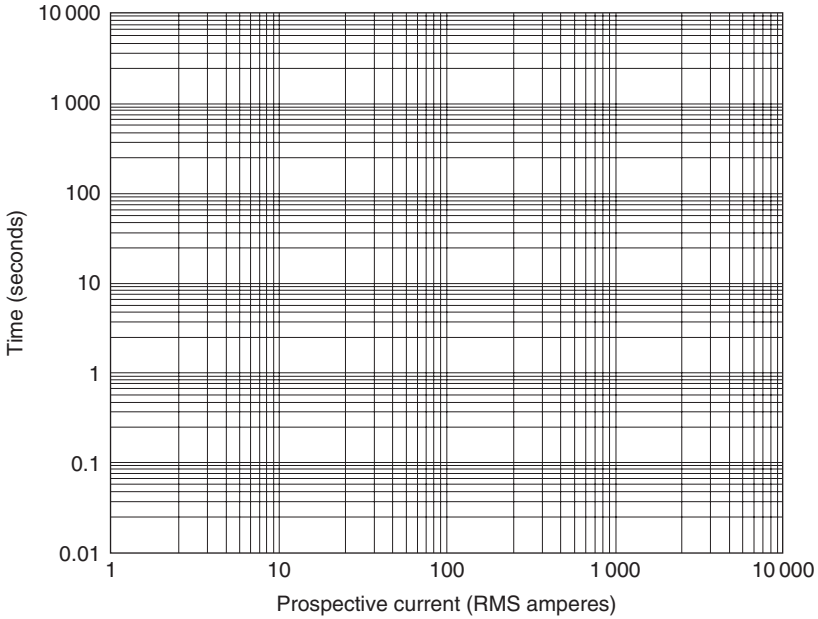


FIGURE 5.7

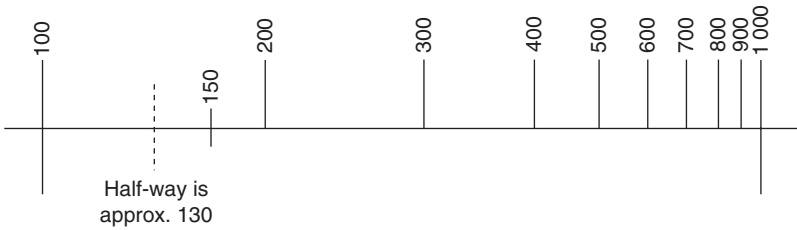
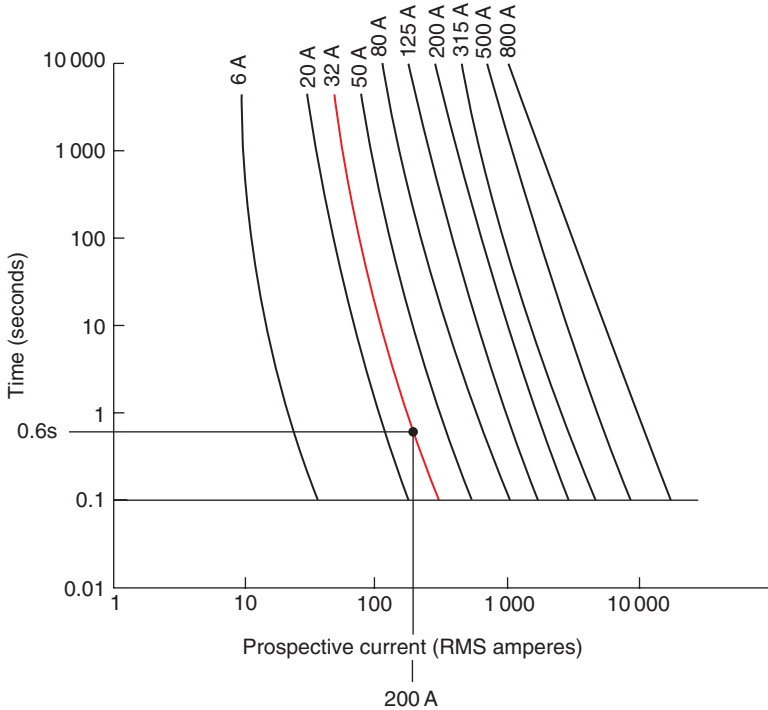


FIGURE 5.8

causes operation of the protective device for disconnection times of 0.1 s, 0.4 s and 5 s.

The IEE Regulations curves for CBs to BS EN 60898 type B and RCBOs are shown in Figure 5.9.

Having found a disconnection time, we can now apply the formula.



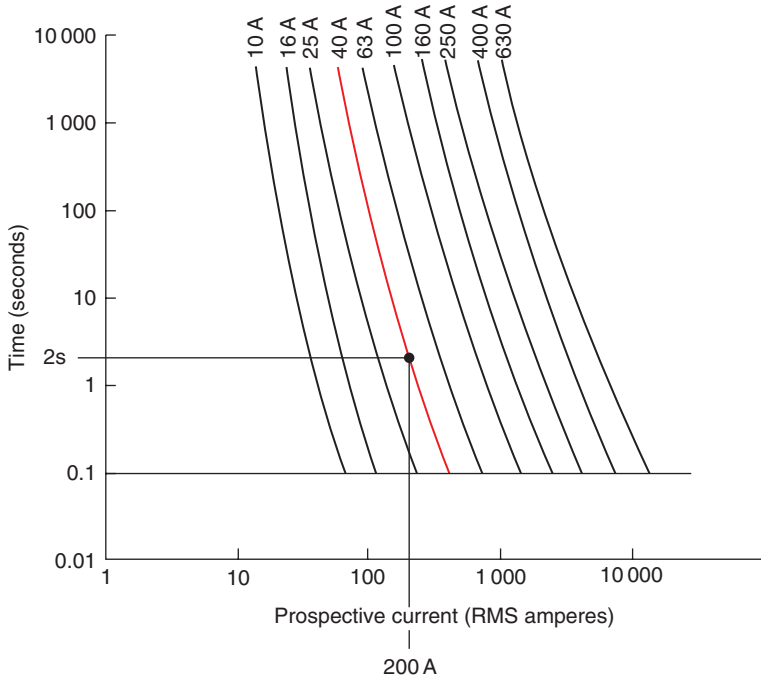
**FIGURE 5.9** Time/current characteristics for fuses to BS 88 Part 2. Example for 32A fuse superimposed.

## EXAMPLE OF USE OF THE ADIABATIC EQUATION

Suppose that in a design the protection was by 40A BS 88 fuse; we had chosen a  $4.0\text{mm}^2$  copper cpc running with our line conductor; and the loop impedance  $Z_s$  was  $1.15\Omega$ . Would the chosen cpc size be large enough to withstand damage in the event of an earth fault? We have:

$$I = U_0/Z_s = 230/1.15 = 200\text{ A}$$

From the appropriate curve for the 40A BS 88 fuse (Figure 5.10), we obtain a disconnection time  $t$  of 2s. From Table 54.3 of



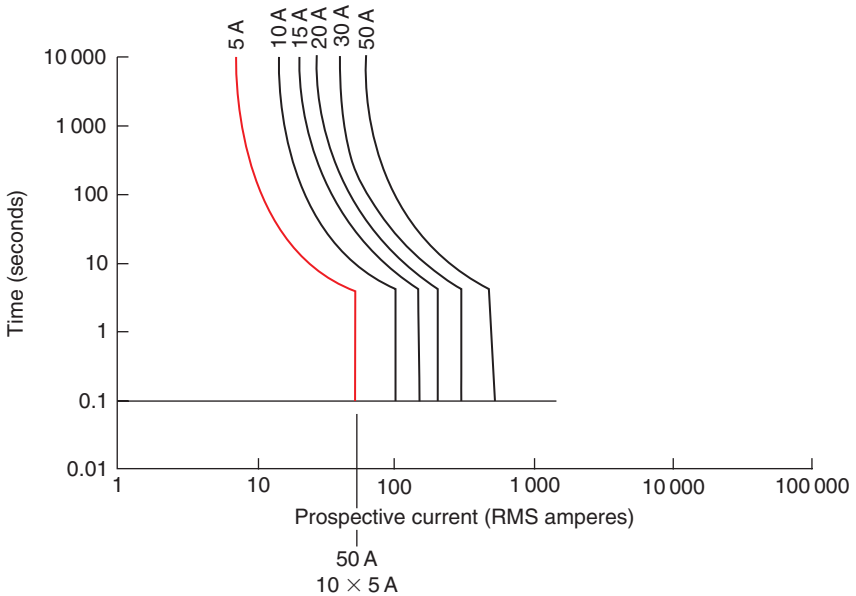
**FIGURE 5.10** Time/current characteristics for fuses to BS 88Part 2. Example for 40A fuse superimposed.

the Regulations,  $k = 115$ . Therefore the minimum size of cpc is given by:

$$s = \frac{\sqrt{I^2t}}{k} = \frac{\sqrt{200^2 \times 2}}{115} = 2.46 \text{ mm}^2$$

So our  $4.0 \text{ mm}^2$  cpc is acceptable. Beware of thinking that the answer means that we could change the  $4.0 \text{ mm}^2$  for a  $2.5 \text{ mm}^2$ . If we did, the loop impedance would be different and hence  $I$  and  $t$  would change; the answer for  $s$  would probably tell us to use a  $4.0 \text{ mm}^2$ .

In the example shown, 's' is merely a check on the actual size chosen.



**FIGURE 5.11** Time/current characteristics for type 3 CBs to BS EN 60898 and RCBOs. Example for 50A superimposed. For times less than 20ms, the manufacturer should be consulted.

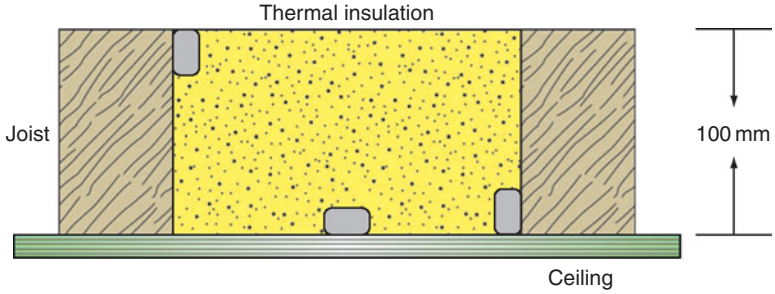
## Installation methods (IEE Regulations Table 4.2)

Figures 5.12–5.18 illustrate some of the common methods of cable installation.

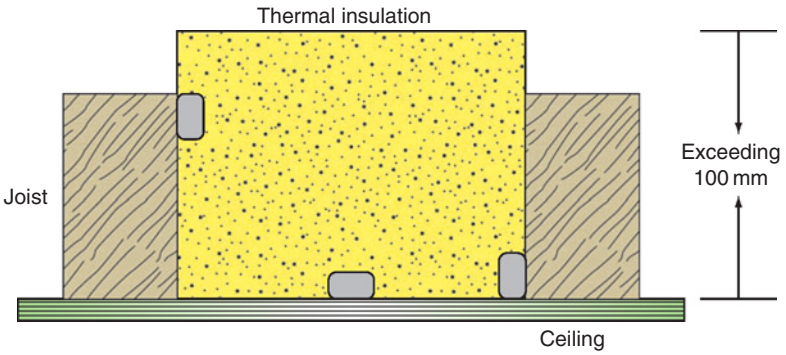
Having discussed each component of the design procedure, we can now put them all together to form a complete design.

## AN EXAMPLE OF CIRCUIT DESIGN

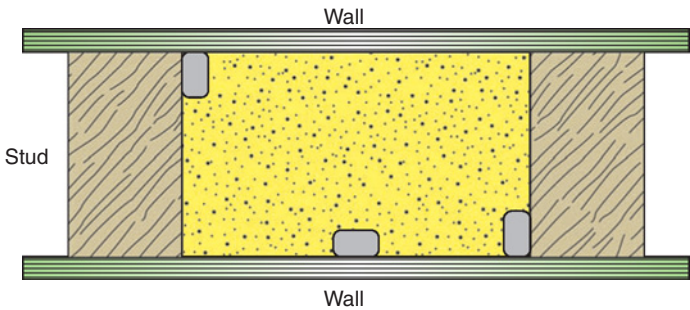
A consumer lives in a bungalow with a detached garage and workshop, as shown in Figure 5.19 (see page 94). The building method is traditional brick and timber.



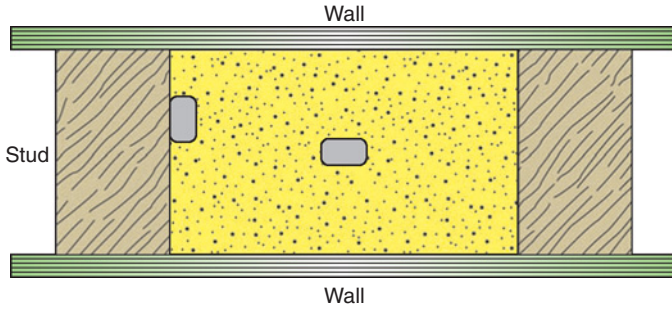
**FIGURE 5.12** Method 100.



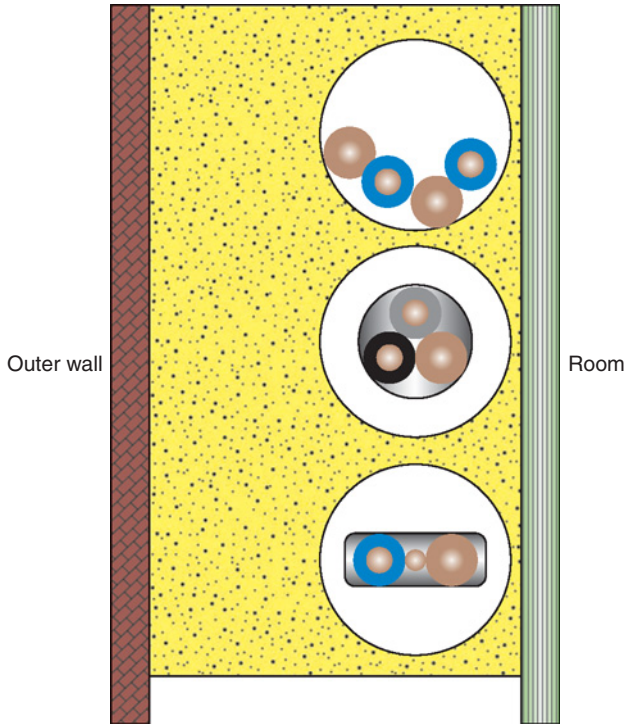
**FIGURE 5.13** Method 101.



**FIGURE 5.14** Method 102.



**FIGURE 5.15** Method 103.



**FIGURE 5.16** Method A.

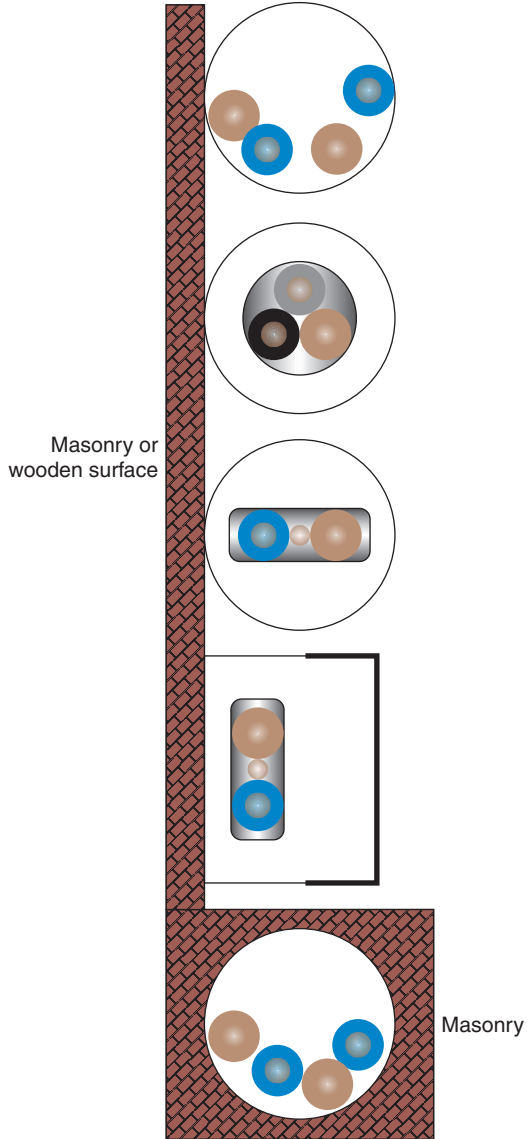
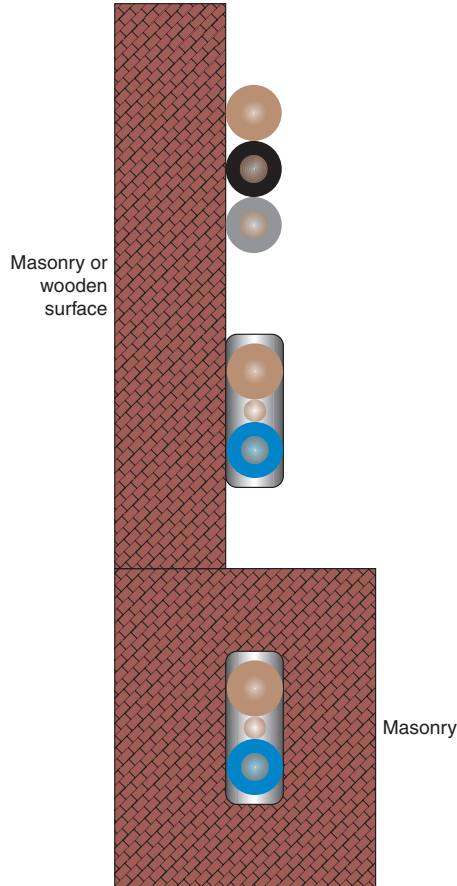


FIGURE 5.17 Method B.



**FIGURE 5.18** Method C.

The mains intake position is at high level and comprises an 80A BS 1361 230V main fuse, an 80A rated meter and a six-way 80A consumer unit housing BS EN 60898 Type B CBs as follows:

Ring circuit	32A
Lighting circuit	6A
Immersion heater circuit	16A
Cooker circuit	32A
Shower circuit	32A
Spare way	–

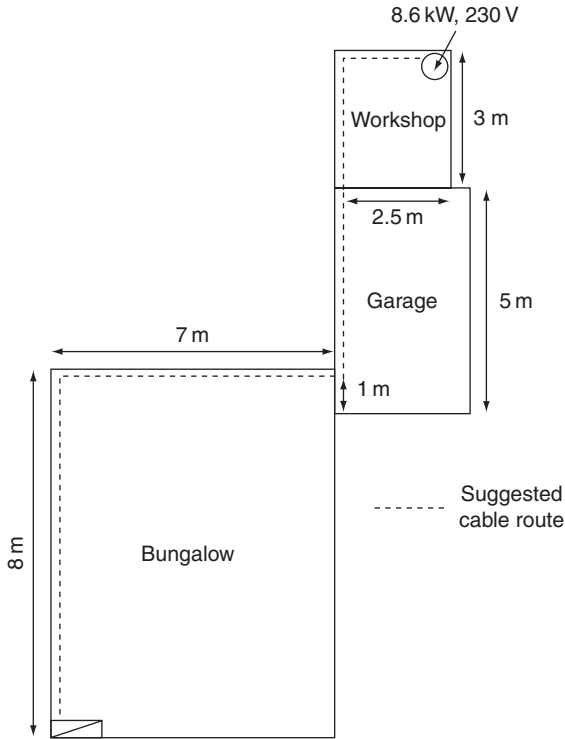


FIGURE 5.19

The cooker is rated at 30 A, with no socket in the cooker unit. The main tails are 16.0 mm<sup>2</sup> double-insulated PVC, with a 6.0 mm<sup>2</sup> earthing conductor. There is no main protective bonding. The earthing system is TN-S, with an external loop impedance  $Z_e$  of 0.3 ohms. The prospective short-circuit current (PSCC) at the origin has been measured as 800 A. The roof space is insulated to full depth of the ceiling joists and the temperature in the roof space is not expected to exceed over 35 °C.

The consumer wishes to convert the workshop into a pottery room and install an 8.6 kW/230 V electric kiln. The design procedure is as follows.

## ASSESSMENT OF GENERAL CHARACTERISTICS

The present maximum demand, applying diversity, is:

Ring	32 A
Lighting (66% of 6 A)	3.96 A
Immersion heater	16 A
Cooker (10 A + 30% of 20 A)	16 A
Shower	32 A
<b>Total</b>	<b>100 A</b>

Reference to the current rating tables in the IEE Regulations will show that the existing main tails are too small and should be up-rated. So, the addition of another 8.6 kW of load is not possible with the present arrangement.

The current taken by the kiln is  $8600/230 = 37.4$  A. Therefore, the new maximum demand is  $100 + 37.4 = 137.4$  A.

Supply details are:

single-phase 230 V, 50 Hz earthing; TN-S PSCC at origin (measured): 800 A.

Decisions must now be made as to the type of cable, the installation method and the type of protective device. As the existing arrangement is not satisfactory, the supply authority must be informed of the new maximum demand, as a larger main fuse and service cable may be required.

## SIZING THE MAIN TAILS

1. The new load on the existing consumer unit will be 137.4 A. From the IEE Regulations, the cable size is  $25.0 \text{ mm}^2$ .
2. The earthing conductor size, from the IEE Regulations, will be  $16.0 \text{ mm}^2$ . The main equipotential bonding conductor size, from the IEE Regulations, will be  $10.0 \text{ mm}^2$ .

For a domestic installation such as this, a PVC flat twin cable, clipped direct (avoiding any thermal insulation) through the loft space and the garage, etc., would be most appropriate.

## SIZING THE KILN CIRCUIT CABLE

**Design current  $I_b$**  is

$$I_b = \frac{P}{V} = \frac{8600}{230} = 37.4 \text{ A}$$

**Rating and type of protection  $I_n$**

As we have seen, the requirement for the rating  $I_n$  is that  $I_n \geq I_b$ . Therefore, using the tables in the IEE Regulations,  $I_n$  will be 40 A.

Correction factors:

$C_a$ : 0.94

$C_g$ : not applicable

$C_c$ : 0.725 **only** if the fuse is BS 3036 (not applicable here)

$C_i$ : 0.5 if the cable is totally surrounded in thermal insulation (not applicable here).

**Tabulated current-carrying capacity of cable**

$$I_t = \frac{I_n}{CF} = \frac{40}{0.94} = 42.5 \text{ A}$$

**Cable size based on tabulated current-carrying capacity**

Table 4D5A IEE Regulations give a size of 6.0 mm<sup>2</sup> for this value of  $I_t$  (method C).

## Check on voltage drop

The actual voltage drop is given by

$$\frac{\text{mV} \times I_b \times 1}{1000} = \frac{7.3 \times 37.4 \times 24.5}{1000} = 6.7 \text{ V}$$

(well below the  
maximum of 11.5 V)

This voltage drop, whilst not causing the kiln to work unsafely, may mean inefficiency, and it is perhaps better to use a 10.0 mm<sup>2</sup> cable.

For a 10.0 mm<sup>2</sup> cable, the voltage drop is checked as

$$\frac{4.4 \times 37.4 \times 24.5}{1000} = 4.04 \text{ V}$$

## Shock risk

The cpc associated with a 10.0 mm<sup>2</sup> twin 6242 Y cable is 4.0 mm<sup>2</sup>. Hence, the total loop impedance will be

$$\begin{aligned} Z_s &= Z_c + \frac{(R_1 + R_2) \times L \times 1.2}{1000} \\ &= 0.3 + \frac{6.44 \times 24.5 \times 1.2}{1000} = 0.489 \Omega \end{aligned}$$

## Note

6.44 is the tabulated ( $R_1 + R_2$ ) value and the multiplier 1.2 takes account of the conductor resistance at its operating temperature.

It is likely that the chosen CB will be a type B.

## Thermal constraints

We still need to check that the 4.0 mm<sup>2</sup> cpc is large enough to withstand damage under earth fault conditions. So, the fault current would be

$$I = \frac{U_0}{Z_s} = \frac{230}{0.489} = 470 \text{ A}$$

The disconnection time  $t$  for this current for this type of protection (from the relevant curve in the IEE Regulations) is as follows.

40 A CB type B = 0.1 s (the actual time is less than this but 0.1 s is the instantaneous time).

From the regulations, the factor for  $k = 115$ . We can now apply the adiabatic equation

$$S = \frac{\sqrt{I^2 \times t}}{k} = \frac{\sqrt{470^2 \times 0.1}}{115} = 1.29 \text{ mm}^2$$

Hence, our 4.0 mm<sup>2</sup> cpc is of adequate size.

## Summary

The kiln circuit would be protected by a 40 A BS EN 60898 type B CB and supplied from a spare way in the consumer unit. The main fuse would need to be up-rated to 100 A. The main tails would be changed to 25.0 mm<sup>2</sup>. The earthing conductor would be changed to 16.0 mm<sup>2</sup>.

Main protective bonding conductors would need to be installed 10.0 mm<sup>2</sup> twin with earth PVC cable.

# Inspection and Testing

## DEFINITIONS USED IN THIS CHAPTER

**Earth electrode** A conductor or group of conductors in intimate contact with and providing an electrical connection with earth.

**Earth fault loop impedance** The impedance of the earth fault loop (line-to-earth loop) starting and ending at the point of earth fault.

**Residual current device (RCD)** An electromechanical switching device or association of devices intended to cause the opening of the contacts when the residual current attains a given value under specified conditions.

**Ring final circuit** A final circuit arranged in the form of a ring and connected to a single point of supply.

## TESTING SEQUENCE (PART 7)

Having designed our installation, selected the appropriate materials and equipment, and installed the system, it now remains to put it into service. However, before this happens, the installation must be tested and inspected to ensure that it complies, as far as is practicable, with the IEE Regulations. Note the word 'practicable'; it would be unreasonable, for example, to expect the whole length of a circuit cable to be inspected for defects, as this may mean lifting floorboards, etc.

Part 6 of the IEE Regulations gives details of testing and inspection requirements. Unfortunately, these requirements pre-suppose that the person carrying out the testing is in possession of all the design data, which is only likely to be the case on the larger commercial or industrial projects. It may be wise for the person who will eventually sign the test certificate to indicate that the test and inspection were carried out as far as was possible in the absence of any design or other information.

However, let us continue by examining the required procedures. The Regulations initially call for a visual inspection, but some items such as correct connection of conductors, etc. can be done during the actual testing. A preferred sequence of tests is recommended, where relevant, and is as follows:

1. Continuity of protective conductors
2. Continuity of ring final circuit conductors
3. Insulation resistance
4. Protection by SELV or PELV or electrical separation
5. Protection by barriers and enclosures provided during erection
6. Insulation of non-conducting floors and walls
7. Polarity
8. Earth electrode resistance
9. Earth fault loop impedance
10. Additional protection
11. Prospective fault current (PFC)
12. Check of phase sequence
13. Functional testing
14. Verification of voltage drop.

Not all of the tests may be relevant, of course. For example, in a domestic installation (TN-S or TN-C-S) only tests 1, 2, 3, 7, 9, 10, 11 and 13 would be needed.

The Regulations indicate quite clearly the tests required in Part 6. Let us then take a closer look at some of them in order to understand the reasoning behind them.

### Continuity of protective conductors

All protective conductors, including main protective and supplementary bonding conductors, must be tested for continuity using a low-reading ohmmeter.

For main protective bonding conductors there is no single fixed value of resistance above which the conductor would be deemed unsuitable. Each measured value, if indeed it is measurable for very short lengths, should be compared with the relevant value for a particular conductor length and size. Such values are shown in Table 6.1.

**Table 6.1**

Conductor Size (mm <sup>2</sup> )	Resistance (mΩ/m)
1.0	18.1
1.5	12.1
2.5	7.41
4.0	4.61
6.0	3.08
10.0	1.83
16.0	1.15
25.0	0.727
35.0	0.524

Where a supplementary protective bonding conductor has been installed between *simultaneously accessible* exposed and extraneous conductive parts, because circuit disconnection times cannot

be met, then the resistance  $R$  of the conductor must be equal to or less than  $50/I_a$ . So:

$$R \leq 50/I_a \Omega$$

where 50 is the voltage, above which exposed metalwork should not rise, and  $I_a$  is the minimum current, causing operation of the circuit protective device within 5 s.

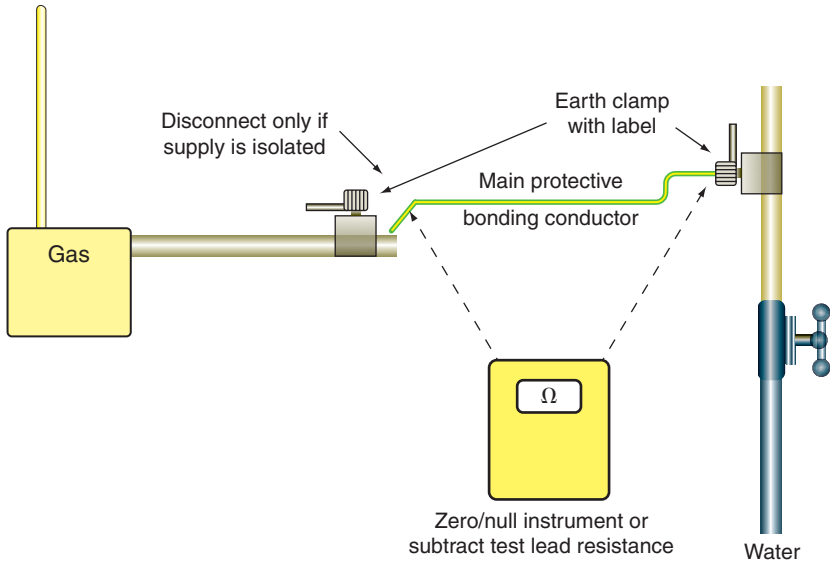
For example, suppose a 45 A BS 3036 fuse protects a cooker circuit. The disconnection time for the circuit cannot be met, and so a supplementary bonding conductor has been installed between the cooker case and the adjacent metal sink. The resistance  $R$  of that conductor should not be greater than  $50/I_a$ , which in this case is 145 A (IEE Regulations). So:

$$50/145 = 0.34 \Omega$$

How, then, do we conduct a test to establish continuity of main or supplementary bonding conductors? Quite simple really: just connect the leads from the continuity tester to the ends of the bonding conductor (Figure 6.1). One end should be disconnected from its bonding clamp, otherwise any measurement may include the resistance of parallel paths of other earthed metalwork. Remember to zero or null the instrument first or, if this facility is not available, record the resistance of the test leads so that this value can be subtracted from the test reading.

### Important Note

If the installation is in operation, then never disconnect main bonding conductors unless the supply can be isolated. Without isolation, persons and livestock are at risk of electric shock.



**FIGURE 6.1** Continuity of main protective bonding conductor.

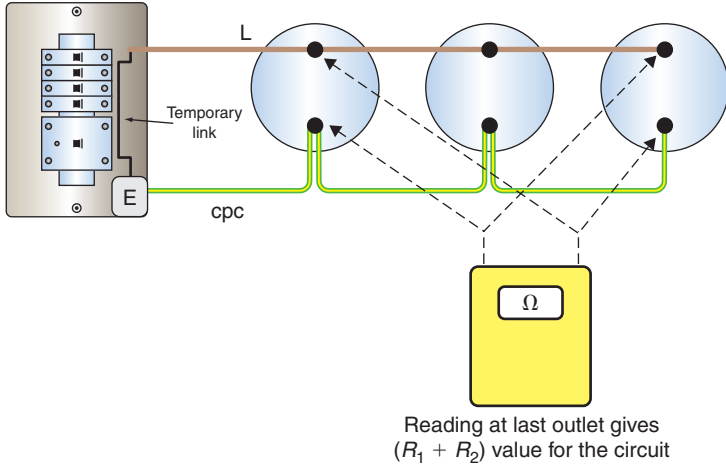
The continuity of circuit protective conductors may be established in the same way, but a second method is preferred, as the results of this second test indicate the value of  $(R_1 + R_2)$  for the circuit in question.

The test is conducted in the following manner:

1. Temporarily link together the line conductor and cpc of the circuit concerned in the distribution board or consumer unit.
2. Test between line and cpc at each outlet in the circuit. A reading indicates continuity.
3. Record the test result obtained at the furthest point in the circuit. This value is  $(R_1 + R_2)$  for the circuit.

Figure 6.2 illustrates the above method.

There may be some difficulty in determining the  $(R_1 + R_2)$  values of circuits in installations that comprise steel conduit and trunking, and/or SWA and mims cables because of the parallel earth paths



**FIGURE 6.2** CPC continuity.

that are likely to exist. In these cases, continuity tests may have to be carried out at the installation stage before accessories are connected or terminations made off as well as after completion.

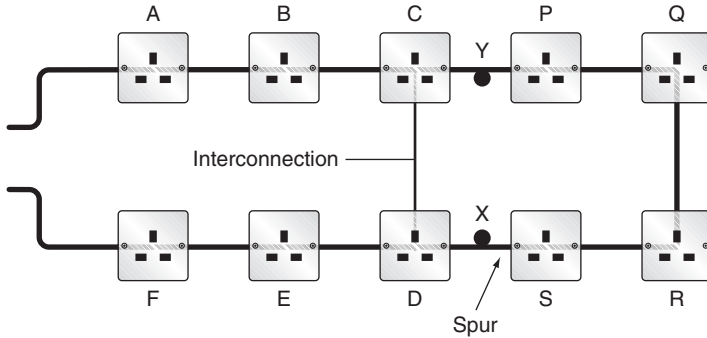
### Continuity of ring final circuit conductors

There are two main reasons for conducting this test:

1. To establish that interconnections in the ring do not exist.
2. To ensure that the circuit conductors are continuous, and indicate the value of  $(R_1 + R_2)$  for the ring.

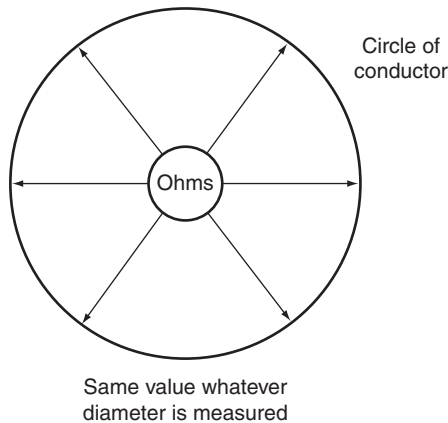
What then are interconnections in a ring circuit, and why is it important to locate them? Figure 6.3 shows a ring final circuit with an interconnection.

The most likely cause of the situation shown in Figure 6.3 is where a DIY enthusiast has added sockets P, Q, R and S to an existing ring A, B, C, D, E and F. In itself there is nothing wrong

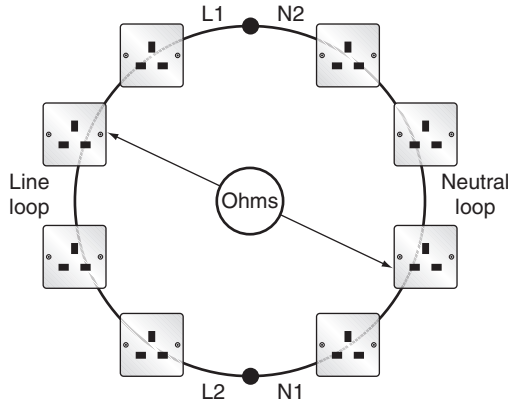


**FIGURE 6.3** Ring circuit with interconnection.

with this. The problem arises if a break occurs at, say, point Y, or the terminations fail in socket C or P. Then there would be four sockets all fed from the point X which would then become a spur. So, how do we identify such a situation with or without breaks at point Y? A simple resistance test between the ends of the line, neutral or circuit protective conductors will only indicate that a circuit exists, whether there are interconnections or not. The following test method is based on the theory that the resistance measured across any diameter of a perfect circle of conductor will always be the same value (Figure 6.4).



**FIGURE 6.4**



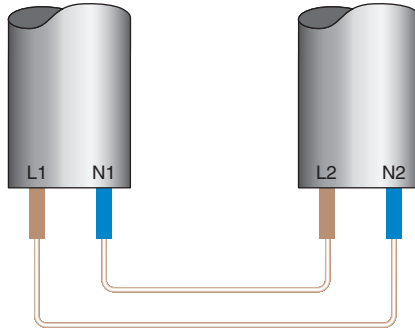
**FIGURE 6.5** Circle formed by cross connection.

The perfect circle of conductor is achieved by cross-connecting the line and neutral loops of the ring (Figure 6.5).

The test procedure is as follows:

1. *Identify the opposite legs of the ring.* This is quite easy with sheathed cables, but with singles, each conductor will have to be identified, probably by taking resistance measurements between each one and the closest socket outlet. This will give three high readings and three low readings, thus establishing the opposite legs.
2. *Take a resistance measurement between the ends of each conductor loop. Record this value.*
3. *Cross-connect the ends of the line and neutral loops* (see Figure 6.6).
4. *Measure between line and neutral at each socket on the ring.* The readings obtained should be, for a perfect ring, substantially the same.

If an interconnection existed such as shown in Figure 6.3 then sockets A to F would all have similar readings, and those beyond



**FIGURE 6.6** L and N cross connection.

the interconnection would have gradually increasing values to approximately the midpoint of the ring, then decreasing values back towards the interconnection. If a break had occurred at point Y then the readings from socket S would increase to a maximum at socket P. One or two high readings are likely to indicate either loose connections or spurs. A null reading, i.e. an open circuit indication, is probably a reverse polarity, either line-cpc or neutral-cpc reversal. These faults would clearly be rectified and the test at the suspect socket(s) repeated.

5. *Repeat the above procedure, but in this case cross-connect the line and cpc loops.* In this instance, if the cable is of the flat twin type, the readings at each socket will very slightly increase and then decrease around the ring. This difference, due to the line and cpc being different sizes, will not be significant enough to cause any concern. The measured value is very important it is  $(R_1 + R_2)$  for the ring.

As before, loose connections, spurs and, in this case, L-N cross-polarity will be picked up.

The details that follow are typical approximate ohmic values for a healthy 70m ring final circuit wired in 2.5 mm<sup>2</sup>/1.5 mm<sup>2</sup> flat twin and cpc cable:

---

Initial measurements	L1–L2	N1–N2	cpc1–cpc2
Reading at each socket	0.26 Ω	0.26 Ω	between 0.32 Ω and 0.34 Ω
For spurs, each metre in length will add the following resistance to the above values	0.015 Ω	0.015 Ω	0.02 Ω

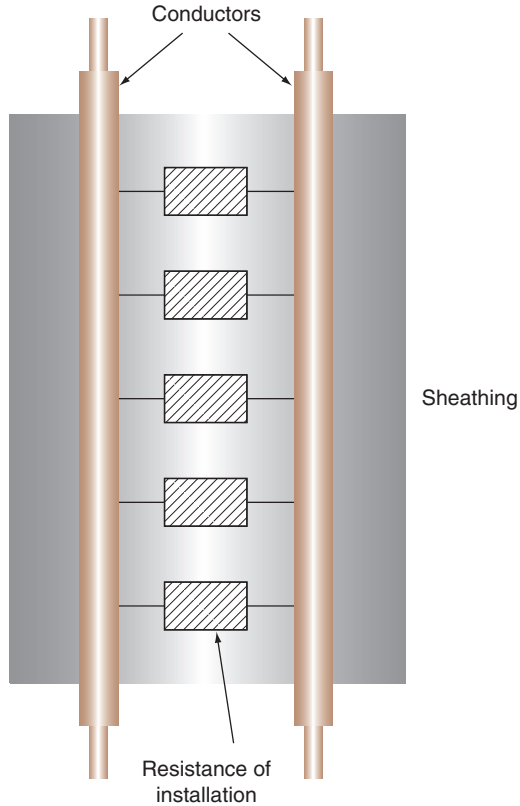
---

### **Insulation resistance**

This is probably the most used and yet most abused test of them all. Affectionately known as ‘meggering’, an insulation resistance test is performed in order to ensure that the insulation of conductors, accessories and equipment is in a healthy condition, and will prevent dangerous leakage currents between conductors and between conductors and earth. It also indicates whether any short circuits exist.

Insulation resistance is the resistance measured between conductors and is made up of countless millions of resistances in parallel (Figure 6.7).

The more resistances there are in parallel, the lower the overall resistance, and in consequence, the longer a cable the lower the insulation resistance. Add to this the fact that almost all installation circuits are also wired in parallel, and it becomes apparent that tests on large installations may give, if measured as a whole, pessimistically low values, even if there are no faults. Under these circumstances, it is usual to break down such large installations into smaller sections, floor by floor, distribution circuit by distribution circuit, etc. This also helps, in the case of periodic testing, to minimize disruption.



**FIGURE 6.7** Cable insulation resistance.

The test procedure, then, is as follows:

1. Disconnect all items of equipment such as capacitors and indicator lamps as these are likely to give misleading results. Remove any items of equipment likely to be damaged by the test, such as dimmer switches, electronic timers, etc. Remove all lamps and accessories and disconnect fluorescent and discharge fittings. Ensure that the installation is disconnected from the supply, all fuses are in place, and CBs and switches are in the on position.

In some instances it may be impracticable to remove lamps, etc. and in this case the local switch controlling such equipment may be left in the off position.

2. Join together all live conductors of the supply and test between this join and earth. Alternatively, test between each live conductor and earth in turn.
3. Test between line and neutral. For three-phase systems, join together all lines and test between this join and neutral. Then test between each of the lines. Alternatively, test between each of the live conductors in turn. Installations incorporating two-way lighting systems should be tested twice with the two-way switches in alternative positions.

Table 6.2 gives the test voltages and minimum values of insulation resistance for ELV and LV systems.

**Table 6.2**

System	Test Voltage	Minimum Insulation Resistance
SELV and PELV	250V DC	0.5 MΩ
LV up to 500V	500V DC	1.0 MΩ
Over 500V	1000V DC	1.0 MΩ

If a value of less than 2 MΩ is recorded it may indicate a situation where a fault is developing, but as yet still complies with the minimum permissible value. In this case each circuit should be tested separately to identify any that are suspect.

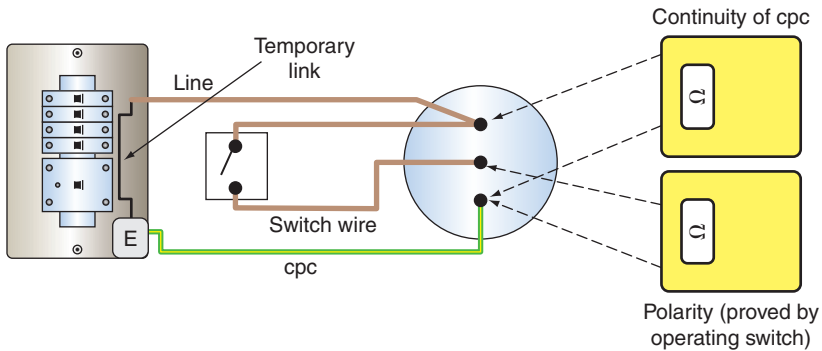
### Polarity

This simple test, often overlooked, is just as important as all the others, and many serious injuries and electrocutions could have been prevented if only polarity checks had been carried out.

The requirements are:

- all fuses and single pole switches are in the line conductor
- the centre contact of an Edison screw type lampholder is connected to the line conductor
- all socket outlets and similar accessories are correctly wired.

Although polarity is towards the end of the recommended test sequence, it would seem sensible, on lighting circuits for example, to conduct this test at the same time as that for continuity of cpcs (Figure 6.8).



**FIGURE 6.8** Lighting polarity.

As discussed earlier, polarity on ring final circuit conductors is achieved simply by conducting the ring circuit test. For radial socket outlet circuits, however, this is a little more difficult. The continuity of the cpc will have already been proved by linking line and cpc and measuring between the same terminals at each socket. Whilst a line-cpc reversal would not have shown, a line-neutral reversal would, as there would have been no reading registered at the socket in question. This would have been remedied, and so only line-cpc reversals need to be checked. This can be done by linking together line and neutral at the origin and testing between

the same terminals at each socket. A line-CPC reversal will result in no reading at the socket in question.

### Earth electrode resistance

As we know, in many rural areas, the supply system is TT and hence reliance is placed on the general mass of earth for a return path under earth fault conditions and the connection to earth is made by an electrode, usually of the rod type.

In order to determine the resistance of the earth return path, it is necessary to measure the resistance that the electrode has with earth. In this instance an earth fault loop impedance test is carried out between the incoming line terminal and the electrode (a standard test for  $Z_e$ ). The value obtained is added to the cpc resistance of the protected circuits and this value is multiplied by the operating current of the RCD. The resulting value should not exceed 50 V.

### Earth fault loop impedance

Overcurrent protective devices must, under earth fault conditions, disconnect fast enough to reduce the risk of electric shock. This is achieved if the actual value of the earth fault loop impedance does not exceed the tabulated maximum values given in BS 7671. The purpose of the test, therefore, is to determine the actual value of the loop impedance  $Z_s$ , for comparison with those maximum values, and it is conducted as follows:

1. Ensure that all main protective bonding is in place.
2. Connect the test instrument either by its BS 1363 plug, or the 'flying leads', to the line, neutral and earth terminals at the remote end of the circuit under test. (If a neutral is not available, connect the neutral probe to earth.)
3. Press to test and record the value indicated.

**Table 6.3** Values of Loop Impedance for Comparison with Test Readings.

Protection	Disconnection Time		5A	6A	10A	15A	16A	20A	25A	30A	32A	40A	45A	50A	60A	63A	80A	100A	125A	160A
BS 3036 fuse	0.4s	$Z_s$ max	7.6	-	-	2.04	-	1.41	-	0.87	-	-	-	-	-	-	-	-	-	-
	5s	$Z_s$ max	14.16	-	-	4.2	-	3.06	-	2.11	-	-	1.27	-	0.89	-	-	0.42	-	-
BS 88 fuse	0.4s	$Z_s$ max	-	6.82	4.09	-	2.16	1.42	1.15	-	0.83	-	-	-	-	-	-	-	-	-
	5s	$Z_s$ max	-	10.8	5.94	-	3.33	2.32	1.84	-	1.47	1.08	-	0.83	-	0.67	0.45	0.33	0.26	0.2
BS 1361 fuse	0.4s	$Z_s$ max	8.36	-	-	2.62	-	1.36	-	0.92	-	-	-	-	-	-	-	-	-	-
	5s	$Z_s$ max	13.12	-	-	4	-	2.24	-	1.47	-	-	0.79	-	0.56	-	0.4	0.29	-	-
BS 1362 fuses	0.4s	$Z_s$ max	(3A) 13.12			(13A) 1.9	-	-	-	-	-	-	-	-	-	-	-	-	-	-
	5s	$Z_s$ max	(3A) 18.56			(13A) 3.06	-	-	-	-	-	-	-	-	-	-	-	-	-	-
BS 3871 MCB Type 1	0.4 & 5 s	$Z_s$ max	9.2	7.6	4.6	3.06	2.87	2.3	1.84	1.53	1.44	1.15	1.02	0.92	-	0.73	-	-	-	-
BS 3871 MCB Type 2	0.4 & 5 s	$Z_s$ max	5.25	4.37	2.62	1.75	1.64	1.31	1.05	0.87	0.82	0.67	0.58	0.52	-	0.42	-	-	-	-
BS 3871 MCB Type 3	0.4 & 5 s	$Z_s$ max	3.68	3	1.84	1.22	1.15	0.92	0.74	0.61	0.57	0.46	0.41	0.37	-	0.29	-	-	-	-
BS EN 60898 CB Type B	0.4 & 5 s	$Z_s$ max	(3A) 12.26	6.13	3.68	-	2.3	1.84	1.47	-	1.15	0.92		0.74	-	0.58	0.46	0.37	0.3	-
BS EN 60898 CB Type C	0.4 & 5 s	$Z_s$ max		3.06	1.84		1.15	0.92	0.75	-	0.57	0.46		0.37	-	0.288	0.23	0.18	0.15	-
BS EN 60898 CB Type D	0.4 & 5 s	$Z_s$ max		1.54	0.92		0.57	0.46	0.37	-	0.288	0.23		0.18	-	0.14	0.12	0.09	0.07	-

It must be understood that this instrument reading is *not valid for direct comparison with the tabulated maximum values*, as account must be taken of the ambient temperature at the time of test, and the maximum conductor operating temperature, both of which will have an effect on conductor resistance. Hence, the  $(R_1 + R_2)$  is likely to be greater at the time of fault than at the time of test.

So, our measured value of  $Z_s$  must be corrected using correction factors and applying them in a formula.

Clearly this method of correcting  $Z_s$  is time-consuming and unlikely to be commonly used. Hence, a rule of thumb method may be applied which simply requires that the measured value of  $Z_s$  does not exceed 0.8 of the appropriate tabulated value. Table 6.3 gives the 0.8 values of tabulated loop impedance for direct comparison with measured values.

In effect, a loop impedance test places a line/earth fault on the installation, and if an RCD is present it may not be possible to conduct the test, as the device will trip out each time the loop impedance tester button is pressed. Unless the instrument is of a type that has a built-in guard against such tripping, the value of  $Z_s$  will have to be determined from measured values of  $Z_e$  and  $(R_1 + R_2)$ .

### Important Note

Never short out an an RCD in order to conduct this test.

As a loop impedance test creates a high earth fault current, albeit for a short space of time, some lower rated CBs may operate, resulting in the same situation as with an RCD, and  $Z_s$  will have to be calculated. It is not really good practice to temporarily replace the CB with one of a higher rating.

## External loop impedance $Z_e$

The value of  $Z_e$  is measured at the intake position on the supply side and with all main protective bonding disconnected. Unless the installation can be isolated from the supply, this test should not be carried out, as a potential shock risk will exist with the supply on and the main protective bonding disconnected.

## Additional protection RCD/RCBO operation

Where RCDs/RCBOs are fitted, it is essential that they operate within set parameters. The RCD testers used are designed to do just this, and the basic tests required are as follows:

1. Set the test instrument to the rating of the RCD.
2. Set the test instrument to half-rated trip.
3. Operate the instrument and the RCD should not trip.
4. Set the instrument to deliver the full rated tripping current of the RCD,  $I_{\Delta n}$ .
5. Operate the instrument and the RCD should trip out in the required time.
6. For RCDs rated at 30 mA or less set the instrument to deliver 5 times the rated tripping current of the RCD,  $5I_{\Delta n}$ .
7. Operate the instrument and the RCD should trip out in 40 ms.

Table 6.4 gives further details.

## Prospective fault current

Prospective fault current (PFC) has to be determined at the origin of the installation. This is achieved by enquiry, calculation or measurement.

**Table 6.4**

RCD Type	Half Rated	Full Trip Current
BS 4293 sockets	no trip	less than 200 ms
BS 4293 with time delay	no trip	½ time delay + 200 ms
BS EN 61009 or BS EN 61009 RCBO	no trip	300 ms
As above, but type S with time delay	no trip	130–500 ms

### Check of phase sequence

Where multi-phase systems are used there is a high possibility that phase sequence will need to be checked.

This is done with the use of a phase rotation indicator, which, simplistically, is a small three-phase motor.

### Functional testing

All RCDs have a built-in test facility in the form of a test button. Operating this test facility creates an artificial out-of-balance condition that causes the device to trip. This only checks the mechanics of the tripping operation; it is not a substitute for the tests just discussed.

All other items of equipment such as switchgear, control gear, interlocks, etc. must be checked to ensure that they are correctly mounted and adjusted and that they function correctly.

### Verification of voltage drop

Where required the voltage drop to the furthest point of a circuit should be determined. This is not usually needed for initial verification.

# Special Locations

## IEE Regulations Part 7

### INTRODUCTION

The bulk of BS 7671 relates to typical, single- and three-phase, installations. There are, however, some special installations or locations that have particular requirements. Such locations may present the user/occupant with an increased risk of death or injuries from electric shock.

BS 7671 categorizes these special locations in Part 7 and they comprise the following:

---

Section 701	Bathrooms, shower rooms, etc.
Section 702	Swimming pools and other basins
Section 703	Rooms containing sauna heaters
Section 704	Construction and demolition sites
Section 705	Agricultural and horticultural premises
Section 706	Conducting locations with restrictive movement
Section 708	Caravan/camping parks
Section 709	Marinas and similar locations
Section 711	Exhibitions shows and stands
Section 712	Solar photovoltaic (PV) power supply systems
Section 717	Mobile or transportable units
Section 721	Caravans and motor caravans
Section 740	Amusement devices, fairgrounds, circuses, etc.
Section 753	Floor and ceiling heating systems

---

Let us now briefly investigate the main requirements for each of these special locations.

## BS 7671 SECTION 701: BATHROOMS, ETC.

This section deals with rooms containing baths, shower basins or areas where showers exist but with tiled floors, for example leisure/recreational centres, sports complexes, etc.

Each of these locations are divided into zones 0, 1 and 2, which give an indication of their extent and the equipment/wiring, etc. that can be installed in order to reduce the risk of electric shock.

So! Out with the tape measure, only to find that in a one-bedroom flat, there may be no zone 2. How can you conform to BS 7671?

The stark answer (mine) is that you may not be able to conform exactly. You do the very best you can in each particular circumstance to ensure safety. Let us not forget that the requirements of BS 7671 are based on reasonableness.

### Zone 0

This is the interior of the bath tub or shower basin or, in the case of a shower area without a tray, it is the space having a depth of 100 mm above the floor out to a radius of 600 mm from a fixed shower head or 1200 mm radius for a demountable head (Figure 7.1).

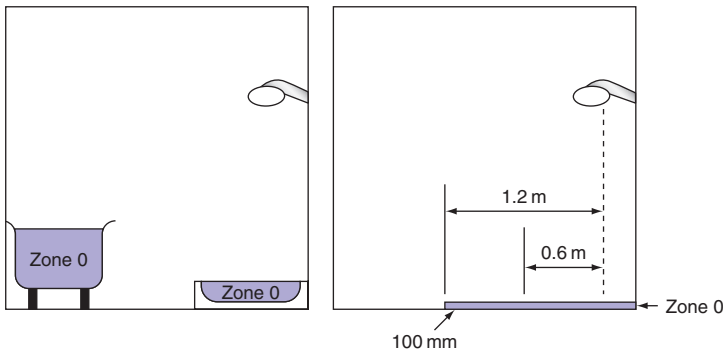


FIGURE 7.1

## Note

- Only SELV (12V) or ripple-free DC may be used as a measure against electric shock, the safety source being outside zones 0, 1 and 2.
- Other than current using equipment specifically designed for use in this zone, **no** switchgear or accessories are permitted.
- Equipment designed for use in this zone must be to at least IPX7.
- Only wiring associated with equipment in this zone may be installed.

## Zone 1

This extends above zone 0 around the perimeter of the bath or shower basin to 2.25m above the floor level, and includes any space below the bath or basin that is accessible without the use of a key or tool. For showers without basins, zone 1 extends out to a radius of 600 mm from a fixed shower head or 1200 mm radius for a demountable head (Figure 7.2).

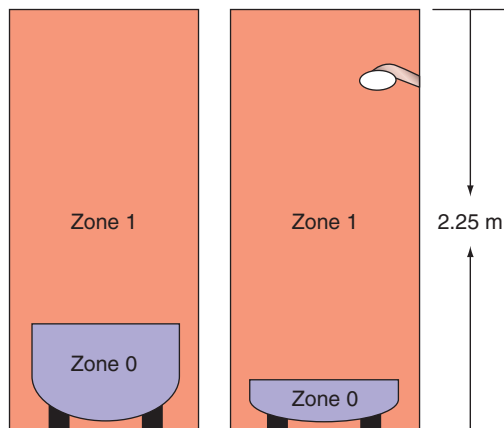


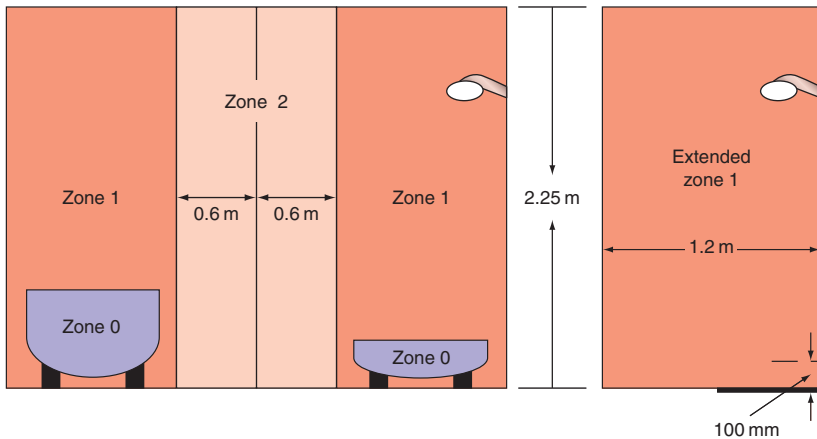
FIGURE 7.2

**Note**

- Other than switches and controls of equipment specifically designed for use in this zone, and cord operated switches, only SELV switches are permitted.
- Provided they are suitable, fixed items of current using equipment such as:  
Showers  
Shower pumps  
Towell rails  
Luminaires  
Etc.
- Equipment designed for use in this zone must be to at least IPX4, or IPX5, where water jets are likely to be used for cleaning purposes.

**Zone 2**

This extends 600 mm beyond zone 1 and to a height of 2.25 m above floor level (Figure 7.3).



**FIGURE 7.3**

## Note

- Other than switches and controls of equipment specifically designed for use in this zone, and cord operated switches, only SELV switches are permitted.
- Equipment designed for use in this zone must be to at least IPX4, or IPX5 where water jets are likely to be used for cleaning purposes.
- For showers without basins there is no zone 2, just an extended zone 1.
- Socket outlets other than SELV may not be installed within 3m of the boundary of zone 1.

## Supplementary equipotential bonding

Supplementary bonding may be established connecting together the cpcs, exposed and extraneous conductive parts within the location.

Such extraneous conductive parts will include:

- metallic gas, water, waste and central heating pipes
- metallic structural parts that are accessible to touch
- metal baths and shower basins.

This bonding may be carried out inside or outside the location, preferably close to the entry of the extraneous conductive parts to the location.

However, this bonding may be omitted if the premises has a protective earthing and automatic disconnection system in place; all extraneous conductive parts of the locations are connected to the protective bonding and all circuits are residual current device (RCD) protected (which they have to be anyway!!).

Electric floor units may be installed below any zone provided that they are covered with an earthed metal grid or metallic sheath and connected to the protective conductor of the supply circuit.

## BS 7671 SECTION 702: SWIMMING POOLS

In a similar fashion to bathrooms and shower rooms, etc., swimming pool locations are also divided into zones 0, 1 and 2:

*Zone 0* is in the pool/basin or fountain.

*Zone 1* extends 2.0 m horizontally from the rim of zone 0 and 2.5 m vertically above it regardless of the pool being above or below ground level. If there are diving boards, shutters or viewing galleries, etc. the height extends to a point 2.5 m from their top surface and 1.5 m horizontally either side of such shutters, etc.

*Zone 2* extends a further 1.5 m horizontally from the edge of zone 1 and 2.5 m above ground level.

Now, what can we install in these zones?

### Zones 0 and 1

#### ***Protection against shock***

Only SELV to be used.

#### ***Wiring systems***

Only systems supplying equipment in these zones are permitted. Metal cable sheaths or metallic covering of wiring systems shall be connected to the supplementary equipotential bonding. Cables should preferably be enclosed in PVC conduit.

#### ***Switchgear, control gear and socket outlets***

None permitted except for locations where there is no zone 2. In this case a switch or socket outlet with an insulated cap or cover may be installed beyond 1.25 m from the edge of zone 0 at a height

of no less than 300 mm. Additionally, the circuits must be protected by:

1. SELV or
2. Automatic disconnection using a 30 mA RCD or
3. Electrical separation.

### ***Equipment***

Only that which is designed for these locations.

Other equipment may be used when the pool/basin is not in use (cleaning, maintenance, etc.) provided the circuits are protected by:

1. SELV or
2. Automatic disconnection using a 30 mA RCD or
3. Electrical separation.

Socket outlets and control devices should have a warning notice indicating to the user that they should not be used unless the location is unoccupied by persons.

## **Zone 2 (there is no zone 2 for fountains)**

### ***Switchgear and control gear***

Socket outlets and switches, provided they are protected by:

1. SELV or
2. Automatic disconnection using a 30 mA RCD or
3. Electrical separation.

### ***IP rating of enclosures***

Zone 0 IPX8 (submersion)

Zone 1 IPX4 (splashproof) or IPX5 (where water jets are used for cleaning)

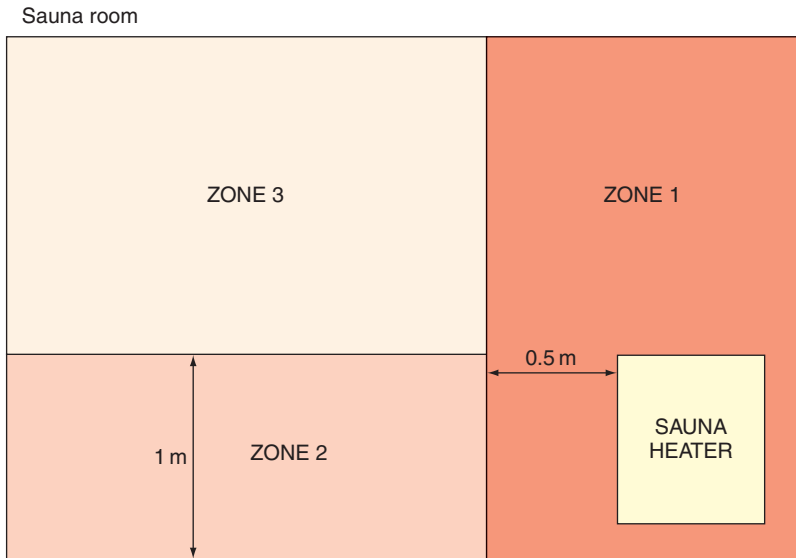
- Zone 2 IPX2 (drip proof) indoor pools
- IPX4 (splashproof) outdoor pools
- IPX5 (where water jets are used for cleaning).

**Supplementary bonding**

All extraneous conductive parts in zones 0, 1 and 2 must be connected by supplementary bonding conductors to the protective conductors of exposed conductive parts in these zones.

**BS 7671 SECTION 703: HOT AIR SAUNAS**

Once again a zonal system, that is, 1, 2 and 3, has been used as per Figure 7.4. In this case the zones are based on temperature.



**FIGURE 7.4**

## Additional protection

All circuits in the location should have additional protection against shock by 30mA RCDs except sauna heater circuits unless recommended by the manufacturer.

## Wiring systems

It is preferred that the wiring systems for the sauna will be installed outside. However, any wiring inside should be heat resistant and any metal sheaths or conduit must be inaccessible in normal use.

## Equipment

All should be at least IPX4 and IPX5 if water jets are to be used for cleaning:

*Zone 1* only the sauna equipment

*Zone 2* no restriction regarding temperature resistance

*Zone 3* must be suitable for 125°C and cable sheaths for 175°C.

## Switchgear, control gear and accessories

Only that which is associated with the sauna heater equipment may be installed in zone 2 and in accordance with the manufacturer's instructions. All other should be outside.

## BS 7671 SECTION 704: CONSTRUCTION SITES

Not as complicated as one may think. The only areas that require special consideration are where construction work is being carried out, not site huts, etc.

So, let us keep all this as simple as possible. Clearly, construction sites are hazardous areas and in consequence the shock risk is greater.

### Protection

For socket outlet circuits of rating up to and including 32A and circuits supplying equipment of rating up to and including 32A, the means of protection shall be:

1. Reduced low voltage (preferred for portable hand tools and hand lamps up to 2kW)
2. Automatic disconnection of supply with additional protection by 30mA RCDs
3. Electrical separation
4. SELV or PELV (SELV being preferred for portable hand lamps in damp locations).

For socket outlet circuits rated above 32A, a 500mA RCD is required.

### External influences

These are not addressed in BS 7671, presumably as there are so many different possibilities. So common sense must prevail and equipment used with an appropriate degree of protection in accordance with the severity of the influence.

### Wiring systems

Apart from some requirements for flexible cables, the only comment relates to ensuring that cables that pass under site roads, etc. are protected against mechanical damage.

## Isolation and switching

An Assembly for Construction Sites (ACS), which is basically the main intake supply board, should comprise a lockable isolator and, for current using equipment and socket outlets:

1. Overcurrent devices
2. Fault protective devices
3. Socket outlets if required.

## Plugs and sockets/cable couplers

All should be to BS EN 60309-2.

## BS 7671 SECTION 705: AGRICULTURAL AND HORTICULTURAL LOCATIONS

The requirements apply only to locations that do not include the main farmhouse outside of which the environment is hazardous and where, of course, livestock is present (animals are susceptible to lethal shock levels at 25 V AC).

## Protection

Protection against shock may be provided by:

1. Automatic disconnection of supply with additional RCD protection for:
  - (a) Final circuits supplying socket outlets rated at 32 A or less (30 mA)
  - (b) Final circuits supplying socket outlets rated more than 32 A (100 mA)
  - (c) All other circuits (300 mA).
2. SELV or PELV.

Protection against thermal effects:

1. Heating appliances should be mounted at appropriate distances from combustible materials and livestock, with radiant heaters at a minimum distance of 0.5 m.
2. For fire protection an RCD rated at 300 mA or less should be used.

### Supplementary bonding

Wherever livestock is housed, supplementary bonding must be carried out connecting all exposed and extraneous conductive parts that can be touched by livestock. All metal grids in floors must be connected to the supplementary equipotential bonding.

### External influences

1. All equipment must be to at least IP44 and luminaires exposed to dust and moisture ingress, IP54.
2. Appropriate protection for socket outlets where influences are greater than AD4, AE3 and/or AG1.
3. Appropriate protection where corrosive substances are present.

### Diagrams

The user of the installation should be provided with plans and diagrams showing the location of all equipment, concealed cable routes, distribution and the equipotential bonding system.

### Wiring systems

Any, just as long as it is suitable for the environment and fulfils the required minimum degrees of protection.

A high impact PVC conduit/trunking system would be appropriate in many cases as it is not affected by corrosion, is rodent proof and

has no exposed conductive parts. However, the system would be designed to suit the particular environmental conditions.

Wiring systems should be erected so as to be, where possible, inaccessible to livestock. Overhead lines should be insulated and, where vehicles/mobile equipment are used, underground cables should be at least 0.6m deep and mechanically protected and 1.0m deep in arable land.

Self-supporting suspended cables should be at a height of at least 6m.

### **Switchgear and control gear**

Whatever! As long as it is suitable for the conditions and that emergency switching is placed in a position inaccessible to livestock and can be accessed in the event of livestock panic (Stampede!!!).

## **BS 7671 SECTION 706: RESTRICTIVE CONDUCTIVE LOCATIONS**

These are very rare locations which could include metal tanks, boilers, ventilation ducts, etc., where access is required for maintenance, repair or inspection. Bodily movement will be severely restricted and in consequence such areas are extremely dangerous.

This section deals with the installation inside the location and the requirements for bringing in accessories/equipment from outside.

For fixed equipment in the location, one of the following methods of protection shall be used:

1. Automatic disconnection of supply but with additional supplementary bonding
2. The use of Class II equipment backed up by a 30 mA RCD
3. Electrical separation
4. SELV.

For hand-held lamps and tools and mobile equipment, SELV or electrical separation should be used.

### **BS 7671 SECTION 708: CARAVAN AND CAMPING PARKS**

We drive into a caravan/camping park for our holiday and need to connect to a supply of electricity for all our usual needs. This is accommodated by the provision of suitably placed socket outlets, supplied via distribution circuits.

#### **External influences**

Equipment should have at least the following protection codes:

1. IPX4 for the presence of splashes (AD4)
2. IP3X for presence of small objects (AE2)
3. IK08 for presence of high severity mechanical stress (AG3)  
(the IK codes are for impact and 08 is an impact of 5 joules).

#### **Wiring systems**

The distribution circuits are erected either underground or overhead:

1. Underground cable (preferred) should be suitably protected against mechanical damage, tent pegs, steel spikes, etc. and at a depth of no less than 0.6 m.
2. If overhead, then 6 m above ground where there is vehicle movement and 3.5 m elsewhere.

#### **Switchgear and socket outlets**

1. Supply equipment should be adjacent to, or within 20 m of, the pitch.

2. Socket outlets should be: to BS EN 60309-2; IP44, at between 0.5 m and 1.5 m above ground, rated not less than 16 A and have individual overcurrent and 30 mA RCD protection.
3. If the supply is TN-C-S the protective conductor of each socket needs to be connected to an earth rod.

## BS 7671 SECTION 709: MARINAS

This location is basically a camping park for boats and has similar requirements to those of caravan/camping parks.

It is where you arrive in your 40ft 8 berth cruiser (some hope) looking for a place to park!!!

However, the environment is a little more harsh than the caravan park due to the possibilities of corrosion, mechanical damage, structural movement and flammable fuels, together with the increased risk of electric shock.

### External influences

Due to the harsh conditions mentioned the classification of influences would include:

- AD water
- AE solid foreign bodies
- AF corrosion and
- AG impact.

### Wiring systems

Distribution circuits, like those in caravan parks, can be either underground or overhead, as well as PVC covered mineral insulated, cables in cable management systems, etc.

However, overhead cables on or incorporating a support wire, cables with aluminium conductors or mineral insulated cables shall not be installed above a jetty or pontoon, etc.

Underground cables should have additional mechanical protection and be installed 0.5 m deep.

Overhead cables should be at the same heights as in caravan parks.

### **Isolation, switching and socket outlets**

Generally the same as caravan parks.

Socket outlets should be installed not less than 1 m above the highest water level except that for floating pontoons, walkways, etc. this height may be reduced to 300 mm.

## **BS 7671 SECTION 711: EXHIBITIONS, SHOWS AND STANDS**

This section deals with the protection of the users of temporary structures erected in or out of doors and is typical of antique fairs, motorbike shows, arts and craft exhibitions, etc.

It does not cover public or private events that form part of entertainment activities, which are the subject of BS 7909.

### **External influences**

None particularly specified. Clearly they must be considered and addressed accordingly.

### **Wiring**

Armoured or mechanically protected cables where there is a risk of mechanical damage.

Cables shall have a minimum conductor size of 1.5 mm<sup>2</sup>.

## Protection

Against shock:

1. Supply cables to a stand or unit, etc. must be protected at the cable origin by a time-delayed RCD of residual current rating not exceeding 300 mA.
2. All socket outlet circuits not exceeding 32A and all other final circuits, excepting emergency lighting, shall have additional protection by 30 mA RCDs.
3. Any metallic structural parts accessible from within the unit stand, etc. shall be connected by a main protective bonding conductor to the main earthing terminal of the unit.

Against thermal effects:

1. Clearly in this case all luminaires, spot lights, etc. should be placed in such positions as not to cause a build-up of excessive heat that could result in fire or burns.

## Isolation

Every unit, etc. should have a readily accessible and identifiable means of isolation.

## Inspection and testing

Tongue in cheek here!! Every installation **should** be inspected and tested on site in accordance with Part 6 of BS 7671.

## BS 7671 SECTION 712: SOLAR PHOTOVOLTAIC (PV) SUPPLY SYSTEMS

These are basically solar panels generating DC which is then converted to AC via an inverter. Those dealt with in BS 7671 relate to those systems that are used to 'top up' the normal supply.

There is a need for consideration of the external influences that may affect cabling from the solar units outside to control gear inside.

There must be protection against overcurrent and a provision made for isolation on both the DC and AC sides of the inverter.

As the systems can be used in parallel with or as a switched alternative to the public supply, reference should be made to Chapter 55 of BS 7671.

### **BS 7671 SECTION 717: MOBILE OR TRANSPORTABLE UNITS**

Medical facilities units, mobile workshops, canteens, etc. are the subject of this section. They are self-contained with their own installation and designed to be connected to a supply by, for instance, a plug and socket.

The standard installation protective measures against shock are required with the added requirement that the automatic disconnection of the supply should be by means of an RCD.

Also all socket outlets for the use of equipment outside the unit should have additional protection by 30 mA RCDs.

The supply cable should be HO7RN-F, oil and flame resistant heavy duty rubber with a minimum copper conductor size of  $2.5 \text{ mm}^2$ .

Socket outlets outside should be to a minimum of IP44.

### **BS 7671 SECTION 721: CARAVANS AND MOTOR CARAVANS**

These are the little homes that people tow behind their cars or that are motorized, not those that tend to be located on a fixed

site. It would be unusual for the general Electrical Contractor to wire new, or even rewire old units. How many of us ever rewire our cars? In consequence, only the very basic requirements are considered here.

## Protection

These units are small houses on wheels and subject to the basic requirements of protection against shock and overcurrent. Where automatic disconnection of supply is used this must be provided by a 30 mA RCD.

## Wiring systems

The wiring systems should take into account the fact that the structure of the unit is subject to flexible/mechanical stresses and, therefore, our common flat twin and three-core cables should not be used.

## Inlets

Unless the caravan demand exceeds 16A, the inlet should conform to the following:

- (a) To BS EN 60309-1 or 2 if interchangeability is required
- (b) No more than 1.8 m above ground level
- (c) Readily accessible and in a suitable enclosure outside the caravan
- (d) Identified by a notice that details the nominal voltage, frequency and rated current of the unit.

Also, inside the caravan, there should be an isolating switch and a notice detailing the instructions for the connection and disconnection of the electricity supply and the period of time between inspection and testing (3 years).

## General

Accessories and luminaires should be arranged such that no damage can occur due to movement, etc.

There should be no compatibility between sockets of low and extra low voltage.

Any accessory exposed to moisture should be IP55 rated (jet proof and dust proof).

## BS 7671 SECTION 740: AMUSEMENT DEVICES, FAIRGROUNDS, CIRCUSES, ETC.

This is not an area that is familiar to most installation electricians and hence will only be dealt with very briefly.

The requirements of this section are very similar to those of Section 711 Exhibitions, shows, etc. and parts of Section 706 Agricultural locations (because of animals) regarding supplementary bonding.

For example, additional protection by 30 mA is required for:

1. Lighting circuits, except those that are placed out of arm's reach and not supplied via socket outlets.
2. All socket outlet circuits rated up to 32 A.
3. Mobile equipment supplied by a flexible cable rated up to 32 A.

Automatic disconnection of supply must be by an RCD.

Equipment should be rated to at least IP44.

The installation between the origin and any equipment should be inspected and tested after each assembly on site.

## BS 7671 SECTION 753: FLOOR AND CEILING HEATING SYSTEMS

Systems referred to in this section are those used for thermal storage heating or direct heating.

### Protection

Against shock:

1. Automatic disconnection of supply with disconnection achieved by 30 mA RCD.
2. Additional protection for Class II equipment by 30 mA RCDs.
3. Heating systems provided without exposed conductive parts shall have a metallic grid of spacing not more than 300 mm installed on site above a floor system or below a ceiling system and connected to the protective conductor of the system.

Against thermal effects:

1. Where skin or footwear may come into contact with floors the temperature shall be limited, for example to 30°C.
2. To protect against overheating of these systems the temperature of any zone should be limited to a maximum of 80°C.

### External influences

Minimum of IPX1 for ceilings and IPX7 for floors.

The designer must provide a comprehensive and detailed plan of the installation which should be fixed on or adjacent to the system distribution board.

This page intentionally left blank

# Appendix 1

## Problems

1. What is the resistance of a 10 m length of  $6.0 \text{ mm}^2$  copper line conductor if the associated cpc is  $1.5 \text{ mm}^2$ ?
2. What is the length of a  $6.0 \text{ mm}^2$  copper line conductor with a  $2.5 \text{ mm}^2$  cpc if the overall resistance is  $0.189 \Omega$ ?
3. If the total loop impedance of a circuit under operating conditions is  $0.96 \Omega$  and the cable is a 20 m length of  $4.0 \text{ mm}^2$  copper with a  $1.5 \text{ mm}^2$  cpc, what is the external loop impedance?
4. Will there be a shock risk if a double socket outlet, fed by a 23 m length of  $2.5 \text{ mm}^2$  copper conductor with a  $1.5 \text{ mm}^2$  cpc, is protected by a 20 A BS 3036 rewirable fuse and the external loop impedance is measured as  $0.5 \Omega$ ?
5. A cooker control unit incorporating a socket outlet is protected by a 32 A BS 88 fuse, and wired in  $6.0 \text{ mm}^2$  copper with a  $2.5 \text{ mm}^2$  cpc. The run is some 25 m and the external loop impedance of the TN-S system is not known. Is there a shock risk.
6. *Design problem:* In a factory it is required to install, side by side, two three-phase 400 V direct on-line motors, each rated at 19 A full load current. There is spare capacity in a three-phase distribution fuseboard housing BS 3036 fuses, and the increased load will not affect the existing installation. The cables are to be PVC-insulated singles installed in steel conduit, and a separate

cpc is required. The earthing system is TN-S with a measured external loop impedance of  $0.47\Omega$ , and the length of the cable run is 42m. The worst conduit section is 7m long with one bend. The ambient temperature is not expected to exceed  $35^{\circ}\text{C}$ . Determine the minimum sizes of cable.

## Appendix 2

### Answers to Problems

1.  $0.152\Omega$
2. 18 m
3.  $0.56\Omega$
4. No
5. Yes.
6. *Design problem:* For the factory design problem, the values obtained are as follows:

$$I_b = 19\text{ A};$$

$$I_n = 20\text{ A};$$

$$C_c = 0.725;$$

$$C_a = 0.94;$$

$$C_g = 0.8;$$

$$I_t = 36.6\text{ A};$$

$$\text{cable size} = 6.0\text{ mm}^2;$$

$$\text{cpc size} = 2.5\text{ mm}^2;$$

$$Z_s = 1\Omega;$$

$$I = 230\text{ A};$$

$$t = 1\text{ s};$$

$$k = 115.$$

This page intentionally left blank

# Index

## A

Adiabatic equation, 84  
Agricultural locations, 127  
Ambient temperature, 73, 76  
Arm's reach, 45, 55  
Assessment of general characteristics, 74, 95

## B

Barriers and enclosures, 100  
Basic protection, 17  
Bathrooms, 118  
Bonding conductor, 17, 27

## C

Cable:  
    construction, 48  
    size, 82  
Caravans, 134  
Caravan and camping parks, 130  
Characteristic curves, 87  
Circuit breaker, 60  
Circuit design, 73–98  
Circuit protective conductor, 17, 27, 45, 73, 84  
Class II equipment, 45, 55  
Conducting location with restricted movement, 129  
Construction sites, 125  
Continuity of protective conductors, 101  
Continuity of ring final circuit conductors, 104  
Current-carrying capacity, 73

## D

Design current, 46, 73, 75  
Disconnection times, 35, 86  
Discrimination, 67

## E

Earth, 17, 19, 22  
Earth electrode, 26, 112  
Earth electrode resistance, 23, 112  
Earth fault current, 31  
Earth fault loop impedance, 17, 30, 112  
Earth free bonding, 56  
Earthing conductor, 18, 73  
Electrical separation, 56  
Electricity at Work Regulations, 5  
Emergency switching, 72  
Equipotential bonding, 18, 22, 26  
Equipotential zone, 27, 44  
Exemption to the Regulations, 57  
Exhibitions, 132  
Exposed conductive parts, 18, 27, 55  
External influences, 46, 51  
Extraneous conductive parts, 18, 46, 55

## F

Fault protection, 18  
Floor and ceiling heating systems, 137  
Functional earthing, 18  
Functional switch, 72  
Functional tests, 116  
Fuses, 60  
Fusing factor, 61

## I

Inspection and testing, 99, 116  
Insulation resistance, 108  
IK codes, 53  
IP codes, 52  
Isolation, 71  
Isolator, 71

## K

K factors, 85

## L

Let-through energy, 65

Live part, 18, 46

## M

Maximum demand, 95

Marinas, 131

Mechanical maintenance, 71

Mechanical protection, 52

Mobile or transportable units, 134

## N

Nominal setting of protection, 76

Non-conducting location, 56

## O

Obstacles, 46, 55

Overcurrent, 47, 59, 73

Overload, 47, 59

## P

Protection, 45–69

Protective conductor, 19

## R

Reduced low voltage, 58

Residual current devices, 38

Ring final circuit, 104

## S

Shock current, 21, 54

Shock risk, 36, 54, 83

Short-circuit current, 47, 59, 64

Simultaneously accessible parts, 19

Skilled person, 47

Solar photovoltaic systems, 133

Supplementary bonding, 27, 42

Swimming pools, 122

Switch, 71

Systems, TT, TN-S, TN-C-S, 28–30

## T

Testing and inspection, 100

Thermal risk to conductors, 84

Thermal insulation, 77

## U

Undervoltage, 69

## V

Voltage drop, 82, 97

## W

Workmanship, 1