

# Electrical Installation Calculations

FOURTH EDITION



**MARK COATES | B.D. JENKINS**



**Electrical Installation Calculations: for Compliance with BS 7671:2008  
Fourth Edition**



---

Representing the best in electrical  
engineering and building services



# Electrical Installation Calculations: for Compliance with BS 7671:2008

**Fourth Edition**

**Mark Coates**

*ERA Technology trading as Cobham Technical Services, UK*

**Brian Jenkins**

*formerly IEE, UK*



Representing the best in electrical  
engineering and building services



A John Wiley and Sons, Ltd, Publication

This edition first published 2010  
© 2010 John Wiley & Sons, Ltd  
First Edition published by Blackwell Publishing in 1991  
Reprinted 1991, 1992, 1993, 1994, 1996  
Second Edition published 1998  
Third Edition published 2003

*Registered office*

John Wiley & Sons Ltd, The Atrium, Southern Gate, Chichester, West Sussex, PO19 8SQ, United Kingdom

For details of our global editorial offices, for customer services and for information about how to apply for permission to reuse the copyright material in this book please see our website at [www.wiley.com](http://www.wiley.com).

The right of the author to be identified as the author of this work has been asserted in accordance with the Copyright, Designs and Patents Act 1988.

All rights reserved. No part of this publication may be reproduced, stored in a retrieval system, or transmitted, in any form or by any means, electronic, mechanical, photocopying, recording or otherwise, except as permitted by the UK Copyright, Designs and Patents Act 1988, without the prior permission of the publisher.

Wiley also publishes its books in a variety of electronic formats. Some content that appears in print may not be available in electronic books.

Designations used by companies to distinguish their products are often claimed as trademarks. All brand names and product names used in this book are trade names, service marks, trademarks or registered trademarks of their respective owners. The publisher is not associated with any product or vendor mentioned in this book. This publication is designed to provide accurate and authoritative information in regard to the subject matter covered. It is sold on the understanding that the publisher is not engaged in rendering professional services. If professional advice or other expert assistance is required, the services of a competent professional should be sought.

ECA is the trademark of the Electrical Contractors' Association.

The ECA is the UK's largest and leading trade association representing electrical, electronic, installation engineering and building services companies.

Website [www.eca.co.uk](http://www.eca.co.uk)

Whilst every care has been taken to ensure the accuracy of the information in this book, neither the author or the ECA can accept liability for any inaccuracies or omissions arising from the information provided.

*Library of Congress Cataloging-in-Publication Data*

Jenkins, Brian D. (Brian David)

Electrical installation calculations : for compliance with BS 7671 : 2008 / Brian Jenkins, Mark Coates. -- 4th ed.  
p. cm.

Includes index.

ISBN 978-1-4443-2426-6 (pbk.)

1. Electric wiring--Mathematics. 2. Electric wiring--Standards--Great Britain. I. Coates, M. (Mark) II. Title.  
TK3211.J44 2010  
621.319'24--dc22

2010010309

ISBN: 978-1444-32426-6

A catalogue record for this book is available from the British Library.

Set in 10/12 pt Baskerville by Sparks – [www.sparkspublishing.com](http://www.sparkspublishing.com)

Printed in the UK by TJ International Ltd



# Contents

<b>About the authors</b>	<b>vii</b>
<b>Preface</b>	<b>ix</b>
<b>Acknowledgements</b>	<b>xi</b>
<b>Symbols</b>	<b>xiii</b>
<b>Definitions</b>	<b>xv</b>
<b>1 Calculation of the cross-sectional areas of circuit live conductors</b>	<b>1</b>
General circuits	4
Circuits in thermally insulating walls	5
Circuits totally surrounded by thermally insulating material	6
Circuits in varying external influences and installation conditions	6
Circuits in ventilated trenches	8
Circuits using mineral-insulated cables	9
Circuits on perforated metal cable trays	10
Circuits in enclosed trenches	11
Circuits buried in the ground	14
Grouped circuits not liable to simultaneous overload	18
Circuits in low ambient temperatures	24
Grouped ring circuits	26
Motor circuits subject to frequent stopping and starting	27
Circuits for star-delta starting of motors	29
Change of parameters of already installed circuits	30
Admixtures of cable sizes in enclosures	33
Grouping of cables having different insulation	39
<b>2 Calculation of voltage drop under normal load conditions</b>	<b>40</b>
The simple approach	40
The more accurate approach taking account of conductor operating temperature	43

The more accurate approach taking account of load power factor	55
The more accurate approach taking account of both conductor operating temperature and load power factor	58
Voltage drop in ring circuits	59
Voltage drop in ELV circuits	62
<b>3 Calculation of earth fault loop impedance</b>	<b>65</b>
The simple approach	70
The more accurate approach taking account of conductor temperature	75
Calculations taking account of transformer impedance	81
Calculations concerning circuits fed from sub-distribution boards	82
Calculations where conduit or trunking is used as the protective conductor	87
Calculations where cable armouring is used as the protective conductor	94
<b>4 Calculations concerning protective conductor cross-sectional area</b>	<b>101</b>
Calculations when the protective device is a fuse	104
Calculations when an external cpc is in parallel with the armour	111
Calculations when the protective device is an mcb	113
Calculations when the protective device is an RCD or RCBO	119
<b>5 Calculations related to short circuit conditions</b>	<b>126</b>
a.c. single-phase circuits	127
The more rigorous method for a.c. single-phase circuits	135
a.c. three-phase circuits	141
<b>6 Combined examples</b>	<b>153</b>
<b>Appendix: The touch voltage concept</b>	<b>175</b>
<b>Index</b>	<b>189</b>



## About the authors

**Mark Coates** BEng collaborated with Brian in developing the First Edition and has since been responsible for revising the subsequent editions. He joined ERA Technology Ltd (now trading as Cobham Technical Services) in July 1983 and is currently a Cable Engineering Consultant. He gained a degree in Mechanical Engineering from Sheffield University (UK) in 1977 and he worked for a chemical and textile company until 1983. Since joining ERA, he has primarily worked on projects to determine cable current ratings both experimentally and by theoretical methods. In addition to the usual cable rating problems, this work has included development of rating methods for mixed groups of cable, cables on winch drums and sub-sea umbilicals. Other projects have included assessments of new cable designs, the mechanical performance of cables and joints, failure analysis of LV, MV and HV transmission and distribution equipment, and life prediction tests for HV cables. He is a member of the UK IEE/BSI Committee concerned with electrical installations, and attends BSI and IEC meetings. He is the convenor of IEC TC20 WG19, the specialist IEC working group responsible for maintaining and updating the International Standards on steady state, cyclic and short-circuit ratings of power cables.

**Brian Jenkins** BSc, CEng, FIEE had many years' industrial experience before working as a Principal Technical Officer at the British Standards Institution. He then joined the Institution of Electrical Engineers as a Senior Technical Officer. Brian passed away in 2007.





## Preface

The publication of BS 7671 and its predecessors, the 15th and 16th Editions of the IEE Wiring Regulations, led to a number of guides and handbooks being published by organizations involved in the electrical contracting industry. These included the publication, by the Institution of Engineering and Technology, of an On-site Guide and a number of Guidance Notes as well as several books by independent authors and a considerable number of articles and papers in the technical press. It also led to numerous instructional courses, seminars and conferences.

It was thought that there was little else one could write about concerning the Wiring Regulations, but after talking to a number of engineers in the electrical installation contracting industry, Brian Jenkins gained the strong impression that there was one need that had not really been satisfied. The need was for a book that made considerable use of worked examples with the absolute minimum discussion of the associated theoretical aspects. In other words, a book which used such examples to show how one carried out the calculations involved in circuit design for compliance with BS 7671.

Whilst Brian designed the book to be primarily of interest and help to those in the smaller companies in the electrical installation contracting industry, we believe the student and the plant engineer will also find it of interest.

BS 7671 offers certain options. For example, when calculating voltage drop either an approximate method or a more accurate one can be used and we have attempted to show where the latter could be used to advantage. This, we believe, will make the book of interest to a wider circle.

BS 7671 does not refer to 'touch voltages' as such, these being the 'voltages between simultaneously accessible exposed and extraneous conductive parts' that may lead to a risk of electric shock in the event of an earth fault. It had long been Brian's opinion that a fuller understanding of the touch voltage concept would assist many in the electrical contracting industry to more fully understand the requirements for automatic disconnection. For this reason we hope that the Appendix will prove to be of interest.

Since the First Edition of this book there have been a number of amendments to the Requirement for Electrical Installations. Some of the changes introduced by the amendments affect the examples given in this book. The most important changes have been the change to the nominal voltage from 240/415 V to 230/400 V, the change to the assumed temperature of conductors under fault conditions and the inclusion of current-carrying capacities for buried cables. New work has also been done to clarify the effectiveness of supplementary circuit protective conductors connected in parallel with the armour of SWA cables. This Fourth Edition is intended to keep *Electrical Installation Calculations* up to date with the latest version of BS 7671. Examples using semi-enclosed fuses have, mainly for legacy, been retained and updated to BS 7671: 2008; although it is recognized that these

devices would not generally be used for new installations, the examples present the reader with the rudiments of the principles of calculations.

There is one final point which needs to be made in this Preface. Examination of some of the answers may suggest to the reader that there is a high intrinsic degree of accuracy in installation design calculations. This obviously cannot be true because, for example, estimated circuit lengths will be rather approximate.

Many of the answers have been given to a greater number of significant figures than is necessary in practice merely to assist the reader should he, or she, wish to check through the examples.

*Mark Coates*





## Acknowledgements

Brian Jenkins acknowledged the initial encouragement and subsequent assistance given by M.J. Dyer when he was Director of Technical Services of the Electrical Contractors' Association and by C.P. Webber BTEch, CEng, MIEE, the present Head of Technical Services of that Association.

He also wished to acknowledge the considerable assistance given by a number of friends who kindly agreed to read his drafts and who offered useful suggestions. In this respect he particularly wished to thank:

F.W. Price, CEng, MIEE

J. Rickwood, BSc (Eng), CEng, FIEE

G. Stokes, BSc, CEng, MIEE, FCIBSE, MISOH

J.F. Wilson, MBE, AMIEE

Brian Jenkins passed away in 2007 having enjoyed his retirement in the North of England where his interests moved from writing on electrical matters to researching local history.

Finally, thanks are due to the Institution of Engineering and Technology for its permission to reproduce a number of the definitions from BS 7671 and to the International Electrotechnical Commission for their permission to reproduce the touch voltage curves shown in the Appendix.

In the compilation of this Fourth Edition Mark Coates wishes to acknowledge the help of Eur Ing Darrell Locke, of the Electrical Contractors' Association, for his assistance as an advisor and critic.





## Symbols

The symbols used in this book are generally aligned with those used in BS 7671 together with some additional symbols which have been found necessary.

Symbols used infrequently are defined where they occur in the text.

- $C_a$  correction factor for ambient temperature
- $C_b$  correction factor for the depth of burial of a buried cable or duct
- $C_c$  overload correction factor for buried cables or cables in buried ducts
- $C_d$  correction factor for type of overcurrent protective device  
 $C_d = 1$  for HBC fuses and mcbs  
 $C_d = 0.725$  for semi-enclosed fuses  
Note:  $C_c$  and  $C_d$  are combined in BS 7671:2008 as  $C_c$  but they are, in fact, two separate factors
- $C_g$  correction factor for grouping
- $C_i$  correction factor for conductors embedded in thermal insulation
- $C_r$  correction factor for grouping of ring circuits
- $C_s$  correction factor for the thermal resistivity of the soil surrounding a buried cable or duct
- $I_b$  design current of circuit, A
- $I_{\Delta n}$  rated residual operating current of an RCD, mA or A
- $I_{ef}$  earth fault current, A
- $I_n$  nominal current of protective device, A
- $I_{sc}$  short circuit current, A
- $I_t$  required tabulated current-carrying capacity, A
- $I_{ta}$  actual tabulated current-carrying capacity, A
- $I_x$  current used as a basis for calculating the required current-carrying capacity of the live conductors, A
- $I_z$  effective current-carrying capacity, A
- $l$  circuit route length, m
- $S$  conductor cross-sectional area, mm<sup>2</sup>
- $t_a$  actual or expected ambient temperature, °C
- $t_o$  maximum permitted conductor temperature under overload conditions, °C
- $t_p$  maximum permitted normal operating conductor temperature, °C
- $t_r$  reference ambient temperature, °C – ( $t_r$  in BS 7671 is 30°C)
- $t_i$  actual conductor operating temperature, °C
- $U_n$  nominal voltage, V

## Symbols

---

$U_o$  nominal voltage to Earth, V

$U_p$  nominal phase voltage, V

$Z_1$  impedance of live conductor, ohms,  $= \sqrt{(R_1^2 + X_1^2)}$  where  $R_1$  is its resistance component and  $X_1$  is its reactance component

$Z_2$  impedance of protective conductor, ohms,  $= \sqrt{(R_2^2 + X_2^2)}$  where  $R_2$  is its resistance component and  $X_2$  is its reactance component

$Z_E$  that part of the earth fault loop impedance which is external to the installation, ohms

$Z_{pn}$  phase to neutral impedance, ohms

$Z_s$  earth fault loop impedance, ohms



## Definitions

The following definitions are of terms which appear in this book and have been aligned, generally without modification, with the definitions in BS 7671:2008.

### Ambient temperature

The temperature of the air or other medium where the equipment is to be used.

### Basic protection

Protection against electric shock under fault-free conditions.

Note: For low voltage installations, systems and equipment, basic protection generally corresponds to protection against direct contact, that is ‘contact of persons or livestock with live parts’.

### Bonding conductor

A protective conductor providing equipotential bonding.

### Bunched

Cables are said to be bunched when two or more are contained within a single conduit, duct, ducting, or trunking or, if not enclosed, are not separated from each other by a specified distance.

### Circuit protective conductor (cpc)

A protective conductor connecting exposed conductive parts of equipment to the main earthing terminal.

### Current-carrying capacity of a conductor

The maximum current which can be carried by a conductor under specified conditions without its steady state temperature exceeding a specified value.

### Design current (of a circuit)

The magnitude of the current (rms value for a.c.) to be carried by the circuit in normal service.

### Direct contact

Contact of persons or livestock with live parts. Deleted in BS 7671:2008, see Basic protection

### Distribution circuit

A circuit supplying a distribution board or switchgear.

A distribution circuit may also connect the origin of an installation to an outlying building or separate installation, when it is sometimes called a sub-main.

### Earth fault current

An overcurrent resulting from a fault of negligible impedance between a line conductor and an exposed-conductive-part or a protective conductor.

### Earth fault loop impedance

The impedance of the earth fault current loop starting and ending at the point of earth fault. This impedance is denoted by  $Z_s$ .

The earth fault loop comprises the following, starting at the point of fault:

- the circuit protective conductor;
- the consumer's earthing terminal and earthing conductor;
- for TN systems, the metallic return path;
- for TT and IT systems, the earth return path;
- the path through the earthed neutral point of the transformer;
- the transformer winding;
- the line conductor from the transformer to the point of fault.

### Earth leakage current

Deleted in BS 7671:2008. See Protective conductor current. A current which flows to earth, or to extraneous-conductive-parts, in a circuit which is electrically sound. This current may have a capacitive component including that resulting from the deliberate use of capacitors.

### Earthing

Connection of the exposed-conductive-parts of an installation to the main earthing terminal of that installation.

### Earthing conductor

A protective conductor connecting the main earthing terminal of an installation to an earth electrode or to other means of earthing.

### Equipotential bonding

Deleted in BS 7671. Previously 'Electrical connection maintaining various exposed-conductive-parts and extraneous-conductive-parts at substantially the same potential.'

### Exposed-conductive-part

A conductive part of equipment which can be touched and which is not normally live, but which may become live when basic insulation fails.

### External influence

Any influence external to an electrical installation which affects the design and safe operation of that installation.

### Extraneous-conductive-part

A conductive part liable to introduce a potential, generally earth potential, and not forming part of the electrical installation.

### Fault current

A current resulting from a fault.

### Fault protection

Protection against electric shock under single-fault conditions.

Note: For low voltage installations, systems and equipment, fault protection generally corresponds to protection against indirect contact, mainly with regard to failure of basic insulation. Indirect contact is 'contact of persons or livestock with exposed-conductive-parts which have become live under fault conditions'.

### Final circuit

A circuit connected directly to current-using equipment, or to a socket-outlet or socket-outlets, or other outlet points for the connection of such equipment.

### Indirect contact

Deleted in BS 7671:2008. See Fault protection.

### Live part

A conductor or conductive part intended to be energized in normal use, including a neutral conductor but, by convention, not a PEN conductor.

### Main earthing terminal

The terminal or bar provided for the connection of protective conductors, including protective bonding conductors, and conductors for functional earthing if any, to the means of earthing.

### Origin of an installation

The position at which electrical energy is delivered to an electrical installation.

### Overcurrent

A current exceeding the rated value. For conductors the rated value is the current-carrying capacity.

### Overload current

An overcurrent occurring in a circuit which is electrically sound.

### PEN conductor

A conductor combining the functions of both protective conductor and neutral conductor.

### Protective conductor

A conductor used for some measures of protection against electric shock and intended for connecting together any of the following parts:

- exposed-conductive-parts
- extraneous-conductive-parts
- the main earthing terminal
- earth electrode(s)
- the earthed point of the source, or an artificial neutral.

### Protective conductor current

Electric current appearing in a protective conductor, such as leakage current or electric current resulting from an insulation fault.

### Residual current

The algebraic sum of the currents flowing in the live conductors of a circuit at a point in the electrical installation.

### Residual current device (RCD)

A mechanical switching device or association of devices intended to cause the opening of the contacts when the residual current attains a given value under specified conditions.

### Residual operating current

Residual current which causes the RCD to operate under specified conditions.

### Ring final circuit

A final circuit arranged in the form of a ring and connected to a single point of supply.

### Short circuit current

An overcurrent resulting from a fault of negligible impedance between live conductors having a difference in potential under normal operating conditions.

## System

An electrical system consisting of a single source, or multiple sources running in parallel, of electrical energy and an installation. For certain purposes (of the Wiring Regulations), types of system are identified as follows, depending upon the relationship of the source, and of exposed-conductive-parts of the installation, to Earth:

- *TN system*, a system having one or more points of the source of energy directly earthed, the exposed-conductive-parts of the installation being connected to that point by protective conductors.
- *TN-C system*, in which neutral and protective functions are combined in a single conductor throughout the system.
- *TN-S system*, having separate neutral and protective conductors throughout the system.
- *TN-C-S system*, in which neutral and protective functions are combined in a single conductor in part of the system.
- *TT system*, a system having one point of the source of energy directly earthed, the exposed-conductive-parts of the installation being connected to earth electrodes electrically independent of the earth electrodes of the source.
- *IT system*, a system having no direct connection between live parts and earth, the exposed-conductive-parts of the electrical installation being earthed.

### Voltage, nominal

Voltage by which an installation (or part of an installation) is designated. The following ranges of nominal voltage (rms values for a.c.) are defined:

- *Extra-low*. Normally not exceeding 50 V a.c. or 120 V ripple free d.c., whether between conductors or to earth.
- *Low*. Normally exceeding extra-low voltage but not exceeding 1000 V a.c. or 1500 V d.c. between conductors, or 600 V a.c. or 900 V d.c. between conductors and earth.
- *High*. Normally exceeding low voltage.

The actual voltage of the installation may differ from the nominal value by a quantity within normal tolerances.



A decorative graphic at the top of the page features a blue background with various mathematical symbols and formulas. On the left, there's a large number '1'. In the center, there are several mathematical expressions:  $11.4 \times 28$ ,  $7.3 \times 2$ ,  $4^2$ ,  $25$ ,  $8$ , and  $2$ . On the right, there's a blue calculator with a white arrow pointing to the number '9' on its keypad. Other numbers like '9', '10', and '406' are scattered around the calculator. The overall theme is technical and mathematical.

# 1

## Calculation of the cross-sectional areas of circuit live conductors

The first stage in designing an installation after having carried out the assessment of general characteristics demanded in Part 3 of BS 7671 is the choice of the type of cable and the method of installation of that cable for each circuit. In some cases these choices are closely interrelated, e.g. non-sheathed cables are required to be enclosed in conduit, duct, ducting or trunking (Regulation 521.10.1).

Where there are several options open to the installation designer from purely technical considerations, the final choice will depend on commercial aspects or the designer's (or client's) personal preferences. Here it is assumed that the designer, after having taken into account the relevant external influences to which the circuit concerned is expected to be subjected, has already decided on the type of cable and the installation method to use. The appropriate table of current-carrying capacity, in Appendix 4 of BS 7671, and the appropriate column within that table are therefore known.

To determine the minimum conductor cross-sectional area of the live conductors of a particular circuit that can be tolerated the designer **must**:

- (a) Establish what is the expected ambient temperature ( $t_a$  °C). This gives the relevant value of  $C_a$ . Note that more than one value of  $t_a$  °C may be encountered in some installations. Where there is more than one value the designer may opt to base all his calculations on the highest value or, alternatively, base his calculations for a particular part of the installation on the value of  $t_a$  °C pertinent to that part.
- (b) Decide whether the circuit is to be run singly or be bunched or grouped with other circuits and, if the latter, how many other circuits. The decision taken gives the relevant value of  $C_g$ .
- (c) Decide whether the circuit is likely to be totally surrounded by thermally insulating material for any part of its length (Regulation 523.7). If the length surrounded by thermal insulation is more than 0.5 m,  $C_i$  is taken to be 0.5. For shorter lengths surrounded by thermal insulation the factors given in Table 52.2 are applied.
- (d) Determine the design current ( $I_b$ ) of the circuit, taking into account diversity where appropriate (Regulation 311.1), and any special characteristics of the load, e.g. motors subject to frequent stopping and starting (Regulation 552.1.1).
- (e) Choose the type and nominal current rating ( $I_n$ ) of the associated overcurrent protective device. For **all** cases  $I_n$  must be equal to or greater than  $I_b$ . Remember that overcurrent protective

devices must comply with Chapter 43 of BS 7671 as regards their breaking capacity, but for the present let it be assumed the chosen devices do so comply.

- (f) Establish whether it is intended the overcurrent protective device is to give:
- (i) overload protection only, or
  - (ii) short circuit protection only, or
  - (iii) overload **and** short circuit protection.

The intended function of the overcurrent protective device not only determines whether  $I_b$  or  $I_n$  is used as the basis for calculating the minimum cross-sectional area of the live conductors, but also influences the value of  $C_a$  that is to be used in the calculations.

- (g) Establish the maximum voltage drop that can be tolerated.
- (h) Estimate the route length of the circuit.

If the cable circuit is to be buried direct in the ground or in buried ducts there are further factors the designer must consider. These factors include:

- (a) The thermal resistivity of the ground. The tabulated ratings given for buried cables in BS 7671 are for cables buried 'in or around buildings'. These ratings assume that the cables are buried in dry made-up ground that is likely to contain rubble, clinker and similar materials having poor thermal properties. Because of this the ratings are based on a soil thermal resistivity of 2.5 K.m/W. This is considerably higher than the accepted value of 1.2 K.m/W for the natural soil in the UK, see BS IEC 60827-3-1. Tabulated ratings for buried cables based on a thermal resistivity of 1.2 K.m/W are given in ERA Reports 69-30 Parts III and IV as well as being provided by some UK cable suppliers. The thermal properties of the soil determine the value of  $C_s$  selected from Table 4B3 of BS 7671.
- (b) The depth of burial of the cables or ducts. The deeper a circuit is buried the lower its current rating. The tabulated ratings given in BS 7671 are for a depth of burial of 0.8 m and no factors are given for different depths of burial. Derating factors for different depths,  $C_b$ , may be obtained from the cable supplier or taken from ERA Report 69-30 Part III or IV. However the ratings in many manufacturers' data and in the ERA reports are for a depth of burial of 0.5 m. Thus the factors for different depths of burial would have to be manipulated before being applied to ratings based on a depth of 0.8 m.
- (c) Ground ambient temperature. The tabulated ratings for buried cables given in BS 7671 are based on a ground ambient temperature of 20°C. This is applicable under buildings, but the designer should be aware that the accepted ground ambient temperature for general conditions in the UK is 15°C, see BS IEC 60287-3-1.
- (d) Overload protection of buried cables. The requirement of Regulation 433.1.1 (iii) is applicable to circuits where the tabulated current ratings are based on an ambient temperature of 30°C. To achieve overload protection for a buried cable circuit the 1.45 factor given in Regulation 433.1.1 (iii) should be reduced to 1.3. In BS 7671 this is achieved by applying a factor of 0.9 to the current-carrying capacity,  $I_z$ , as required by Regulation 433.1.4. As an alternative the overload protective device should be selected such that  $I_2 < 1.3I_z$ .

It cannot be emphasized too strongly that unless all the foregoing items are available it is not possible to design any circuit.

The general method for the determination of the minimum conductor cross-sectional areas that can be tolerated now described does **not** apply to cables installed in **enclosed** trenches. These are considered later in this chapter. The general method is as follows:

First calculate the current  $I_t$  where:

$$I_t = I_x \times \frac{1}{C_a} \times \frac{1}{C_g} \times \frac{1}{C_i} \times \frac{1}{C_d} \times \frac{1}{C_c} \times \frac{1}{C_s} \times \frac{1}{C_b} \text{ A}$$

Table 1.1 indicates when  $I_x = I_b$  and when  $I_x = I_n$ . Table 1.1 also indicates from which tables in Appendix 4 of BS 7671 the appropriate values of  $C_a$  and  $C_g$  are found and it gives the values of  $C_d$  to use. For all buried cable circuits,  $C_c = 0.9$  where the current,  $I_2$ , causing effective operation of the protective device is 1.45 times the rated current,  $I_n$ , of the protective device. Where  $I_2 \geq 1.3 \times I_n$ ,  $C_c = 1$ . The value of  $C_s$  for a buried circuit is selected from Table 4B3.

$C_i$  (when applicable) is, in the absence of more precise information, taken to be 0.5 and the calculation is then based on the tabulated current-carrying capacity for Reference Method B, i.e. for cables clipped direct to a surface and open. Note that even when the cable concerned is installed in thermal insulation for comparatively short lengths (up to 400 mm), Regulation 523.7 specifies derating factors varying from 0.89 to 0.55.

Having calculated  $I_t$ , inspect the appropriate table of current-carrying capacity in Appendix 4 and the appropriate column in that table to find that conductor cross-sectional area having an **actual** tabulated current-carrying capacity ( $I_{ta}$ ) equal to or greater than the calculated  $I_t$ .

Note that in the following examples the circuit lengths are not given and therefore the voltage drops are not calculable. The examples are concerned solely with the determination of conductor cross-sectional areas for compliance with the requirements in BS 7671 regarding the thermal capability of cables under normal load conditions and, where appropriate, under overload conditions.

Remember that Regulation 435.1 allows the designer to assume that, if the overcurrent protective device is intended to provide both overload and short circuit protection, there is no need to carry out further calculation to verify compliance with the requirement (given in Regulation 434.5.2) regarding the latter. That assumption has been made in the following examples. When the overcurrent protective device is intended to provide short circuit protection only (e.g. in motor circuits), however, it is essential that the calculations described in Chapter 5 are made.

**Table 1.1** Selection of current and of correction factors

Overcurrent protective device	Protection provided	For $I_x$ use	Obtain $C_a$ from	Obtain $C_g$ from	$C_d$
Semi-enclosed fuses to BS 3036	Overload with or without short circuit	$I_n$	Table 4B1 or 4B2	Table 4C1 or 4C2	0.725
	Short circuit only	$I_b$	Table 4B1 or 4B2	Table 4C1 or 4C2	1
HBC fuses to BS 88 Pt 2 or Pt 6 or BS 1361 or mcbs	Overload with or without short circuit	$I_n$	Table 4B1 or 4B2	Table 4C1 or 4C2	1
	Short circuit only	$I_b$	Table 4B1 or 4B2	Table 4C1 or 4C2	1

Overcurrent protective devices are also frequently intended to provide automatic disconnection of the supply in the event of an earth fault (i.e. to provide protection against indirect contact) and the calculations that are then necessary are described in Chapter 3.

In practice, particularly with single-phase circuits which are not bunched, it will be found that voltage drop under normal load conditions determines the cross-sectional area of the circuit live conductors that can be used. For this reason Chapter 2 deals with voltage drop calculations as these are sensibly the next stage in circuit design.

## General circuits

### Example 1.1

A single-phase circuit is to be wired in insulated and sheathed single-core cables having copper conductors and thermoplastic insulation, 70°C. The cables are to be installed in free air, horizontal, flat spaced on cable supports (Reference Method E).

If  $I_b = 135$  A,  $t_a = 50^\circ\text{C}$  and overload and short circuit protection is to be provided by a BS 88–2.2 ‘gG’ fuse, what is the minimum current rating for that fuse and the minimum cross-sectional area of the cable conductors that can be used?

### Answer

Because  $I_n \geq I_b$ , select  $I_n$  from the standard ratings of BS 88–2.2. Therefore  $I_n = 160$  A.

From Table 4B1,  $C_a = 0.71$ . As there is no grouping,  $C_g = 1$ . Also  $C_i = 1$  and  $C_d = 1$ .

Thus:

$$I_t = 160 \times \frac{1}{0.71} \text{ A} = 225.4 \text{ A}$$

From Table 4D1A Column 11 it is found that 50 mm<sup>2</sup> is inadequate because  $I_{ta}$  would be only 219 A. The minimum conductor cross-sectional area that can be used is 70 mm<sup>2</sup> having  $I_{ta} = 281$  A.

### Example 1.2

A d.c. circuit has a design current of 28 A. It is to be wired in a two-core cable having 90°C thermosetting insulation and copper conductors. It is to be installed in trunking with five other similar circuits.

If  $t_a = 40^\circ\text{C}$  and the circuit is to be protected by a 45 A HBC fuse to BS 1361 against short circuit faults only, what is the minimum conductor cross-sectional area that can be used?

### Answer

From Table 4C1,  $C_g = 0.57$  (there being a total of six circuits).

From Table 4B1,  $C_a = 0.91$ . Also  $C_i = 1$  and  $C_d = 1$ .

Thus:

$$I_t = 28 \times \frac{1}{0.91} \times \frac{1}{0.57} \text{ A} = 54 \text{ A}$$

From Table 4E2A Column 2 the minimum conductor cross-sectional area that can be used is found to be  $10 \text{ mm}^2$  having  $I_{ta} = 57 \text{ A}$ .

Note that in this example the  $I_b$  of  $28 \text{ A}$  is used to determine  $I_t$  because only short circuit protection is intended and that it is still necessary to check that the  $10 \text{ mm}^2$  conductors will comply with Regulation 434.5.2, using the procedure described in Chapter 5.

### Example 1.3

A single-phase circuit has  $I_b = 17 \text{ A}$  and is to be wired in flat two-core (with cpc)  $70^\circ \text{ C}$  thermoplastic insulated and sheathed cable having copper conductors, grouped with four other similar cables, all clipped direct.

If  $t_a = 45^\circ \text{ C}$  and the circuit is to be protected against both overload and short circuit by a semi-enclosed fuse to BS 3036, what should be the nominal current rating of that fuse and the minimum cross-sectional area of cable conductor?

### Answer

Because  $I_n \geq I_b$  select from the standard ratings for BS 3036 fuses,  $I_n = 20 \text{ A}$ .

From Table 4C1,  $C_g = 0.60$  (there being a total of five circuits).

From Table 4B1,  $C_a = 0.79$ . Also  $C_i = 1$  and  $C_d = 0.725$ .

Thus:

$$I_t = 20 \times \frac{1}{0.79} \times \frac{1}{0.60} \times \frac{1}{0.725} \text{ A} = 58.2 \text{ A}$$

From Table 4D5A Column 7 it is found that the minimum conductor cross-sectional area that can be used is  $10 \text{ mm}^2$  having  $I_{ta} = 64 \text{ A}$ .

## Circuits in thermally insulating walls

### Example 1.4

Five similar three-phase circuits each having  $I_b = 30 \text{ A}$  are to be wired in single-core  $70^\circ \text{ C}$  thermoplastic insulated non-sheathed cables having copper conductors. The circuits are installed in trunking in a thermally insulating wall, the trunking being in contact with a thermally conductive surface on one side (Reference Method A).

If the circuits are protected against both overload and short circuit by  $32 \text{ A}$  BS 88–2.2 ‘gG’ fuses and  $t_a = 45^\circ \text{ C}$ , what is the minimum conductor cross-sectional area that can be used?

### Answer

From Table 4C1,  $C_g = 0.60$ . From Table 4B1,  $C_a = 0.79$ . Also  $C_i = 1$  and  $C_d = 1$ .

Thus:

$$I_t = 32 \times \frac{1}{0.79} \times \frac{1}{0.60} \text{ A} = 67.5 \text{ A}$$

From Table 4D1A Column 3 it is found that the minimum conductor cross-sectional area that can be used is 25 mm<sup>2</sup> having  $I_{ta} = 73$  A.

## Circuits totally surrounded by thermally insulating material

### Example 1.5

Six similar single-phase circuits each having  $I_b = 8$  A are to be wired in single-core 70°C thermoplastic insulated non-sheathed cables having copper conductors. The cables are enclosed in conduit totally surrounded by thermally insulating material.

If the ambient temperature is expected to be 45°C and each circuit is protected by a 10 A miniature circuit breaker against both overload and short circuit, what is the minimum cross-sectional area of conductor that can be used?

### Answer

From Table 4C1,  $C_g = 0.57$ . From Table 4B1,  $C_a = 0.79$ .

The relevant table of current-carrying capacity is Table 4D1A. Column 2 must **not** be used because it relates to Reference Method A where the conduit enclosing the cable(s) is in contact with a thermally conductive surface on one side. In this example the conduit is totally surrounded by thermally insulating material: Regulation 523.7 indicates that in such cases the factor  $C_i (= 0.5)$  has to be related to the current-carrying capacities for cables clipped direct (Reference Method C). Thus:

$$I_t = 10 \times \frac{1}{0.79} \times \frac{1}{0.57} \times \frac{1}{0.5} \text{ A} = 44.4 \text{ A}$$

From Column 6 of Table 4D1A it is found that the minimum conductor cross-sectional area that can be used is 6 mm<sup>2</sup> having  $I_{ta} = 47$  A.

Note that exactly the same procedure must be used if the cable(s) concerned are not in conduit but still totally surrounded by thermally insulating material. Regulation 523.7, as already indicated, gives derating or correction factors for cables installed in thermal insulation for comparatively short lengths, i.e. up to 0.4 m.

## Circuits in varying external influences and installation conditions

In practice, the problem is frequently encountered that a circuit is so run that the relevant values of  $C_a$  and/or  $C_g$  are not constant or applicable over the whole circuit length. In such cases, **provided that the Reference Method does remain the same**, the quickest way of determining the minimum conductor cross-sectional area that can be used is to calculate the product  $C_a C_g$  for each section of the circuit and then to use the **lowest** such product in the equation for determining  $I_t$ .

### Example 1.6

A single-phase circuit is to be wired in single-core 70°C thermoplastic insulated non-sheathed cables having copper conductors and protected against both overload and short circuit by a 25 A BS 88-2.2

'gG' fuse. For approximately the first third of its route it is run in trunking with six other similar circuits in an ambient temperature of 30°C. For the remaining two-thirds of its route it is run in conduit on a wall but with no other circuits and where the ambient temperature is 50°C.

Determine the minimum conductor cross-sectional area that can be used.

### Answer

The method of installation is Reference Method B throughout, so proceed as follows.

For the first third of the route:  $C_a = 1$  and, from Table 4C1,  $C_g = 0.54$ .

Thus:

$$C_a C_g = 0.54.$$

For the remaining two-thirds of the route: from Table 4B1,  $C_a = 0.71$  but  $C_g = 1$ .

Thus:

$$C_a C_g = 0.71$$

The more onerous section of the route is therefore the first third, i.e. in the trunking and

$$I_t = \frac{25}{0.54} \text{ A} = 46.3 \text{ A}$$

From Table 4D1A Column 4 it is found that the minimum conductor cross-sectional area that can be used is 10 mm<sup>2</sup> having  $I_{ta} = 57 \text{ A}$ . The designer has two options. Either the whole circuit is run in 10 mm<sup>2</sup> or a check can be made to find out if it would be possible to reduce the cross-sectional area over that part of the circuit run singly in conduit.

In the present case for that part:

$$I_t = \frac{25}{0.71} \text{ A} = 35.2 \text{ A}$$

Again from Table 4D1A Column 4 it would be found that a conductor cross-sectional area of 6 mm<sup>2</sup> could be used. Whether the designer opts to take advantage of this is a matter of personal choice.

Now consider the case where the Reference Method is **not** the same throughout. Then the procedure to use is to treat each section separately and using the appropriate values of the relevant correction factors calculate the required  $I_t$ .

### Example 1.7

A three-phase circuit having  $I_b = 35 \text{ A}$  is to be wired in multicore non-armoured 70°C thermoplastic insulated and sheathed cables having copper conductors and is protected against both overload and short circuit by a TP&N 40A miniature circuit breaker (mcb). For approximately three-quarters of its length it is run in trunking with four other similar circuits in an expected ambient temperature

of 25°C. For the remaining part of its route it is run singly clipped direct to a wall but where the ambient temperature is 45°C.

Determine the minimum conductor cross-sectional area that can be used.

### Answer

When grouped in trunking: from Table 4C1,  $C_g = 0.6$ . From Table 4B1,  $C_a = 1.03$ .

Thus:

$$I_t = 40 \times \frac{1}{1.03} \times \frac{1}{0.60} \text{ A} = 64.7 \text{ A}$$

From Table 4D2A Column 5 the minimum conductor cross-sectional area that can be used is found to be 25 mm<sup>2</sup> having  $I_{ta} = 80 \text{ A}$ .

When run singly, clipped direct: from Table 4B1,  $C_a = 0.79$ . Also  $C_g = 1$ .

Thus:

$$I_t = 40 \times \frac{1}{0.79} \text{ A} = 50.6 \text{ A}$$

From Table 4D2A Column 7 the minimum conductor cross-sectional area that can be used is found to be 10 mm<sup>2</sup> having  $I_{ta} = 57 \text{ A}$ .

Whether, for the circuit concerned, the designer opts to reduce the cable cross-sectional area where it exits from the trunking, is a matter of personal choice.

## Circuits in ventilated trenches

### Example 1.8

Four similar single-phase circuits are to be wired in single-core non-armoured 70°C thermoplastic insulated and sheathed cables having aluminium conductors. These cables are to be supported on the walls of a ventilated trench (Installation Method 56) vertically spaced by at least one cable diameter.

If, for each circuit,  $I_b = 175 \text{ A}$  and each circuit is to be protected by a 200 A BS 88–2.2 ‘gG’ fuse against short circuit current only, what is the minimum conductor cross-sectional area that can be used,  $t_a$  being 50°C?

### Answer

Inspection of Table 4C1 shows that no grouping factor ( $C_g$ ) is given for spaced cables fixed to a surface. Provided the cable spacing of at least one cable diameter is used,  $C_g = 1$ . From Table 4B1,  $C_a = 0.71$ .

Thus:

$$I_t = 175 \times \frac{1}{0.71} \text{ A} = 246.5 \text{ A}$$

According to Table 4A2 Reference Method B is applicable to Installation Method 56. From Table 4H1A Column 4 the minimum conductor cross-sectional area that can be used is found to be  $185 \text{ mm}^2$  having  $I_{ta} = 266 \text{ A}$ .

### Example 1.9

Seven similar three-phase circuits are to be wired in multicore non-armoured  $70^\circ\text{C}$  thermoplastic insulated and sheathed cables having copper conductors. These cables are to be supported on the walls of a ventilated trench (Installation Method 56) spaced at least two cable diameters apart.

If, for each circuit,  $I_b = 55 \text{ A}$  and each circuit is to be protected by  $63 \text{ A}$  BS 88–2.2 ‘gG’ fuses against both overload and short circuit, what is the minimum conductor cross-sectional area that can be used,  $t_a$  being  $35^\circ\text{C}$ ?

### Answer

Inspection of Table 4C1 shows that no grouping factor ( $C_g$ ) is given for spaced cables installed on a surface. Provided a cable spacing of at least two cable diameters is used,  $C_g = 1$ . From Table 4B1,  $C_a = 0.94$ .

Thus:

$$I_t = 63 \times \frac{1}{0.94} \text{ A} = 67 \text{ A}$$

From Table 4D2A Column 5 the minimum conductor cross-sectional area that can be used is found to be  $25 \text{ mm}^2$  having  $I_{ta} = 80 \text{ A}$ .

Note that in Table 4A2 there are no spacing requirements for multicore cables. Note 2 to Table 4C1 states that no rating factor needs to be applied if the horizontal clearance between adjacent cables exceeds twice their overall diameter. No advice is given in BS 7671 for clearances between cables mounted vertically, one above another. It is suggested that the vertical clearance between cables should be at least three times the cable diameter. Because of the restricted air flow in trenches, even in ventilated trenches, the number of horizontal layers of cables should be limited. Of course, wherever possible, the spacing between cables should be as large as the trench dimensions allow. It should be noted that, for large single-core cables, an increase in the spacing will increase the voltage drop.

## Circuits using mineral-insulated cables

The next two examples illustrate two important points concerning mineral-insulated cables.

### Example 1.10

A single-phase circuit is run in light duty, thermoplastic covered, mineral-insulated cable, clipped direct. The circuit is protected by a  $25 \text{ A}$  semi-enclosed fuse to BS 3036 against both overload and short circuit.

If  $t_a = 45^\circ\text{C}$ , what is the minimum conductor cross-sectional area that can be used?

**Answer**

From Table 4B1,  $C_a = 0.78$ .

Thus:

$$I_t = 25 \times \frac{1}{0.78} \text{ A} = 32.1 \text{ A}$$

From Table 4G1A Column 2 the minimum conductor cross-sectional area that can be used is found to be  $4 \text{ mm}^2$  having  $I_{ta} = 40 \text{ A}$ .

Note that although protection is being provided by a semi-enclosed fuse it is **not** necessary to use the 0.725 factor normally associated with such fuses in order to determine  $I_t$ .

Also note that had the cable been bare and exposed to touch, Note 2 to Table 4G1A indicates that the tabulated values have to be multiplied by 0.9 and  $I_{ta}$  would then have been 36 A. In this case  $4 \text{ mm}^2$  conductors would still be acceptable.

**Example 1.11**

Six similar single-phase circuits are run in heavy duty single-core mineral-insulated cables, bare and not exposed to touch, bunched and clipped direct.

If each circuit is protected by a 50 A BS 88-2.2 'gG' fuse against both overload and short circuit and  $t_a = 35^\circ\text{C}$ , what is the minimum conductor cross-sectional area that can be used?

**Answer**

From Table 4B1, for  $105^\circ\text{C}$  sheath temperature,  $C_a = 0.96$ .

Thus:

$$I_t = 50 \times \frac{1}{0.96} \text{ A} = 52.1 \text{ A}$$

From Table 4G2A Column 2 the minimum conductor cross-sectional area that can be used is found to be  $4 \text{ mm}^2$  having  $I_{ta} = 55 \text{ A}$ .

Note that as indicated in Note 2 to Table 4G2A it is **not** necessary to apply a grouping factor. For mineral-insulated cables exposed to touch or having thermoplastic covering it is, however, necessary to apply grouping factors, as given in Table 4C1, 4C4 or 4C5.

**Circuits on perforated metal cable trays****Example 1.12**

Six similar three-phase circuits are to be run in multicore non-armoured cables having  $90^\circ\text{C}$  thermosetting insulation and copper conductors, installed as a single layer on a perforated metal cable tray.

If each circuit is protected against both overload and short circuit by a 50 A mcb and  $t_a = 60^\circ\text{C}$ , what is the minimum conductor cross-sectional area that can be used?

### Answer

Examination of Table 4C4 shows that the factors given in Table 4C1 should be used for touching cables and those in Table 4C4 should be used for cables with a clearance of one cable diameter between them.

Not enough information has been given in the example and the assumption has to be made that the cables are touching;  $C_g$  is therefore 0.73.

From Table 4B1,  $C_a = 0.71$ . Thus:

$$I_t = 50 \times \frac{1}{0.73} \times \frac{1}{0.71} \text{ A} = 96.5 \text{ A}$$

From Table 4E2A Column 9 it is found that the minimum conductor cross-sectional area that can be used is 16 mm<sup>2</sup> having  $I_{ta} = 100 \text{ A}$ .

Where circuits on trays use a variety of conductor sizes in multiple layers, ERA Publications 69–30 Parts 6 and 7 give a method for calculation of those sizes.

### Circuits in enclosed trenches

As indicated earlier the procedure adopted for the foregoing examples may not be applicable for cables installed in **enclosed** trenches.

In the 16th edition of the IEE Wiring Regulations, BS 7671:2001, and earlier editions installation methods 18 to 20 and Table 4B3 covered specific arrangements of cables in enclosed trenches. In the 17th edition, BS 7671:2008 there are several different installation methods applicable to cables in building voids and cable ducting in masonry. An alternative approach for determining current ratings for cables in enclosed trenches is given in BS IEC 60287–2-1. The designer must decide which of the available approaches is appropriate for any particular installation. Example 1.13 compares the results of using two different approaches. The result obtained using the 16th edition approach is given for comparison.

#### Example 1.13

A three-phase circuit having  $I_b = 55 \text{ A}$  is installed in an enclosed trench with five other similar circuits. The circuits are to be run in multicore armoured 70°C thermoplastic insulated cables having copper conductors and each is to be protected against both overload and short circuit by 63 A BS 88–2.2 ‘gG’ fuses. The circuits are to be installed in a trench 450 mm wide by 600 mm deep and  $t_a = 40^\circ\text{C}$ .

Determine the minimum conductor cross-sectional area that can be used.

#### Answer using 16th edition approach

The derating factors from the 16th edition gave the result that the minimum conductor cross-sectional area that can be used is 25 mm<sup>2</sup>.

### Answer using 17th edition approach

A study of Table 4A2 shows that either Installation Method 40 or 46 may be applicable in this case. In both of these Installation Methods the method is limited to a certain range of depths of void in relation to the cable diameter. Because the cable diameter is not known before the appropriate conductor cross-sectional area has been determined, the limits have to be reversed to determine the acceptable range of cable diameters,  $D_e$ , for the known depth of void,  $V$ . The limits for Installation Method 40 are  $1.5D_e \leq V \leq 20D_e$ , thus for  $V = 600$ , Installation Method 40 can be used for cable diameters between 30 mm and 400 mm. Similarly for a void depth of 600 mm Installation Method 46 can be used for cable diameters between 12 mm and 400 mm. From this the use of Method 40 may be marginal but the use of Method 46 is acceptable. However both Methods call up Reference Method B for the current ratings.

In this example there are six circuits in the same trench, thus it is clear that a group rating factor has to be applied. Table 4C1 has grouping factors for touching cables that are enclosed. However these grouping factors apply to bunched cables that are in a relatively small enclosure. The designer may consider that these factors are not appropriate for cables in a relatively large trench.

For this example it is considered that the grouping factors given for touching cables in a single layer on a wall or floor are more appropriate.  $C_g$  is therefore taken to be 0.72. From Table 4B1,  $C_a = 0.87$ .

Thus:

$$I_t = 63 \times \frac{1}{0.72} \times \frac{1}{0.87} \text{ A} = 100.6 \text{ A}$$

Installation Methods 40 and 46 call up Reference Method B for the current ratings. Unfortunately Table 4D4A does not give current ratings for Reference Method B so the current rating must be estimated. Table 4D2A and Table 4D4A both have ratings for Reference Method C and it is noted that the rating for an armoured cable is higher than that for an unarmoured cable of the same conductor size. For a cable having a rating of close to 100 A, 35 mm<sup>2</sup>, the ratio of the armoured to non-armoured rating for Reference Method C is:

$$\frac{125}{119} = 1.05$$

It is reasonable to expect that the same ratio could be applied for Reference Method B. From Table 4D2A Column 5 the tabulated rating for a 35 mm<sup>2</sup> cable is 99 A. Thus the estimated Reference Method B rating for a 35 mm<sup>2</sup> armoured cable is  $1.05 \times 99 = 104 \text{ A}$ . From this the minimum conductor cross-sectional area that can be used is 35 mm<sup>2</sup> having  $I_{ta} = 104 \text{ A}$ .

### Answer using BS IEC 60287-2-1 approach

An empirical method for calculating the current rating of cables in an enclosed trench is given in BS IEC 60287-2-1. This method involves calculating the effective increase in ambient temperature in the trench from the total power dissipation of all the cables in the trench and the perimeter length of the trench. The effective increase in ambient temperature is added to the actual ambient

temperature and the derating factor for the new ambient temperature is found. The cable size is then selected on the basis of this derating factor and the ratings for Reference Method E.

The empirical equation for the effective increase in ambient temperature,  $\Delta\theta$ , given in BS IEC 60287-2-1 is:

$$\Delta\theta_t = \frac{W_{\text{tot}}}{3P}$$

where:

$W_{\text{tot}}$  = total heat dissipation from all of the cables in the trench, W/m

$P$  = perimeter length of trench,  $2 \times \text{width} + 2 \times \text{depth}$ , m.

For multicore cables and non-armoured single-core cables, the heat dissipation can be calculated from the voltage drop values given in BS 7671. The heat dissipation, per core, is given by  $I^2R$ , where  $I$  is the load current and  $R$  is the conductor resistance per metre length. The 'r' component of the voltage drop values given in BS 7671 for a single-phase circuit equates to  $2 \times R$ . Because the conductor size is not known an initial estimate of the required size must be made and the calculations repeated if necessary.

As an initial estimate it is assumed that a 25 mm<sup>2</sup> cable is to be used. From Column 3 of Table 4D4B,  $r = 1.75$ . The power dissipation from one cable is then given by:

$$W = 3 \times 55^2 \times \frac{1.75}{2 \times 1000} = 7.94 \text{ W/m}$$

There are six cables in the trench so

$$W_{\text{tot}} = 6 \times 7.94 = 47.6 \text{ W/m}$$

The perimeter length of the trench is

$$P = 2 \times 0.45 + 2 \times 0.6 = 2.1 \text{ m}$$

The effective ambient temperature is

$$\theta_a = 40 + \frac{47.6}{2.1} = 62.7^\circ\text{C}$$

From Table 4B1, for an ambient temperature of 60°C,  $C_a = 0.5$ .

From Table 4D4A, column 5,  $I_{\text{ta}} = 110 \text{ A}$ . Thus:

$$I_z = 0.5 \times 110 = 55 \text{ A}$$

As this result is less than  $I_n$ , a conductor cross-sectional area of  $25 \text{ mm}^2$  is not acceptable so try  $35 \text{ mm}^2$ .

For this size

$$W_{\text{tot}} = 6 \times 55^2 \times \frac{1.25}{2 \times 1000} = 34 \text{ W/m}$$

and hence

$$\theta_a = 40 + \frac{34}{2.1} = 56.2^\circ\text{C}$$

From Table 4B1, for an ambient temperature of  $55^\circ\text{C}$ ,  $C_a = 0.61$ . From Table 4D4A, Column 5,  $I_{\text{ta}} = 135 \text{ A}$ . Thus:

$$I_z = 0.61 \times 135 = 82 \text{ A}$$

As this result is greater than  $I_n$ , the minimum conductor cross-sectional area that can be used is  $35 \text{ mm}^2$ . This is the same conductor cross-sectional area as that found by using Installation Method 46.

## Circuits buried in the ground

As indicated earlier, there are additional factors that have to be considered when selecting the appropriate cross-sectional area for buried cable circuits. In addition to any correction for ground ambient temperature and grouping, factors relating to the soil thermal resistivity and depth of burial may also apply. The factor  $C_c$  is also applicable if the circuit is to be protected against overload and the overload factor of the protective device is greater than 1.3, Regulation 433.1.4.

The tabulated current-carrying capacities given in Appendix 4 of BS 7671 for cables buried in the ground are for cables buried in ducts at a depth of  $0.8 \text{ m}$  in material having a thermal resistivity of  $2.5 \text{ K.m/W}$  with a ground temperature of  $20^\circ\text{C}$ . These conditions may relate to cables buried in relatively dry made-up ground, in built-up areas, containing large quantities of rubble and other foreign materials. The nominal ground conditions usually assumed in the UK for cables buried in the natural soil are an ambient temperature of  $15^\circ\text{C}$  and a thermal resistivity of  $1.2 \text{ K.m/W}$ . These conditions are defined in BS IEC 60287-3-1.

As well as decreasing with increasing soil thermal resistivity, current-carrying-capacities of buried cables also decrease with increasing depth of burial. Rating factors for different depths of burial are not given in BS 7671 and those given in some manufacturers' data and ERA Report 69-30 Part III would have to be manipulated to apply to ratings based on a depth of  $0.8 \text{ m}$ . However IEC 60502-2 contains depth factors for current ratings based on a depth of  $0.8 \text{ m}$ . Although these factors were calculated for  $11 \text{ kV}$  cables they can be applied to low voltage cables. The factors given in IEC 60502-2 are reproduced in Tables 1.2 and 1.3.

**Table 1.2** Correction factors for depths of laying for direct buried cables

Depth of laying, m	Single-core cables		3-core cables
	Nominal conductor size, mm <sup>2</sup>		
	<185 mm <sup>2</sup>	>185 mm <sup>2</sup>	
0.5	1.04	1.06	1.04
0.6	1.02	1.04	1.03
1	0.98	0.97	0.98
1.25	0.96	0.95	0.96
1.5	0.95	0.93	0.95
1.75	0.94	0.91	0.94
2	0.93	0.90	0.93
2.5	0.91	0.88	0.91
3	0.90	0.86	0.90

**Table 1.3** Correction factors for depths of laying for cables in ducts

Depth of laying, m	Single-core cables		3-core cables
	Nominal conductor size, mm <sup>2</sup>		
	<185 mm <sup>2</sup>	>185 mm <sup>2</sup>	
0.5	1.04	1.05	1.03
0.6	1.02	1.03	1.02
1	0.98	0.97	0.99
1.25	0.96	0.95	0.97
1.5	0.95	0.93	0.96
1.75	0.94	0.92	0.95
2	0.93	0.91	0.94
2.5	0.91	0.89	0.93
3	0.90	0.88	0.92

The description of Reference Method D given in Clause 7.1 of Appendix 4 of BS 7671 notes that the current-carrying capacity of a direct buried cable is approximately 10% higher than the tabulated value in BS 7671, for the stated soil conditions.

### Example 1.14

A three-phase circuit having  $I_b = 35\text{ A}$  is to be wired in multicore armoured  $90^\circ\text{C}$  thermosetting insulated and sheathed cables having copper conductors and is protected against both overload and short circuit by a 40 A BS 88–2.2 gG fuse. The cable is to be direct buried in the ground across a ‘brown field’ site where the soil conditions are not known. The cable is to be buried at a depth of 0.5 m.

Determine the minimum conductor cross-sectional area that can be used.

### Answer

The soil conditions are not known, but because of the nature of the site it is assumed that the soil has a poor thermal resistivity. Thus the soil conditions used for the tabulated current-carrying capacities are taken to be applicable.

The overload factor for a BS 88–2.2 fuse is 1.45 thus:  $C_c = 0.9$ .

Because the cable is direct buried, the tabulated current-carrying capacity can be increased by a factor of 1.1.

From Table 1.2,  $C_b = 1.04$ .

Thus:

$$I_t = 40 \times \frac{1}{0.90} \times \frac{1}{1.1} \times \frac{1}{1.04} \text{ A} = 38.9 \text{ A}$$

From Table 4E4A Column 7 the minimum conductor cross-sectional area that can be used is found to be  $6\text{ mm}^2$  having  $I_{ta} = 44\text{ A}$ .

### Example 1.15

This example is the same as Example 1.14 except the cable is to be buried in soil having an ambient temperature of  $15^\circ\text{C}$  with a thermal resistivity of  $1.2\text{ K.m/W}$ . The three-phase circuit is protected against both overload and short circuit by a 40 A BS 88–2.2 gG fuse. The cable is to be buried at a depth of 0.5 m.

Determine the minimum conductor cross-sectional area that can be used.

### Answer

From Table 4B2,  $C_a = 1.04$ . From Table 4B3,  $C_s = 1.5$  for a thermal resistivity of  $1\text{ K.m/W}$  and  $C_s = 1.28$  for a thermal resistivity of  $1.5\text{ K.m/W}$ .

For a thermal resistivity of  $1.2\text{ K.m/W}$ ,  $C_s$  is found by interpolation as follows:

$$C_s = 1.5 - \frac{(1.5-1.28)}{(1.5-1)} \times (1.2-1) = 1.4$$

$$C_c = 0.9$$

From Table 1.2,  $C_b = 1.04$ .

Because the factors for ambient temperature and soil thermal resistivity have been applied, the note in Clause 7.1 of Appendix 4 is no longer applicable and hence the factor of 1.1 is not applicable.

Thus:

$$I_t = 40 \times \frac{1}{1.04} \times \frac{1}{1.4} \times \frac{1}{0.9} \times \frac{1}{1.04} \text{ A} = 29.4 \text{ A}$$

From Table 4E4A Column 7 the minimum conductor cross-sectional area that can be used is found to be  $4 \text{ mm}^2$  having  $I_{ta} = 36 \text{ A}$ .

If the cable selection is based on published current-carrying capacities tabulated for a ground ambient temperature of  $15^\circ\text{C}$  and a soil thermal resistivity of  $1.2 \text{ K.m/W}$  the factors  $C_a$  and  $C_s$  are not applied.

Thus:

$$I_t = 40 \times \frac{1}{0.9} \text{ A} = 44.4 \text{ A}$$

From Table 5 of ERA Report 69–30 Part V the minimum conductor cross-sectional area that can be used is found to be  $4 \text{ mm}^2$  having  $I_{ta} = 47 \text{ A}$ .

### Example 1.16

A three-phase circuit having  $I_b = 52 \text{ A}$  is to be wired in multicore armoured  $90^\circ\text{C}$  thermosetting insulated and sheathed cables having copper conductors and is protected against both overload and short circuit by a  $63 \text{ A}$  circuit breaker having an overload factor of 1.3. The cable is to be installed in buried ducts with two other similar circuits in adjacent touching ducts. The soil has an ambient temperature of  $15^\circ\text{C}$  and a thermal resistivity of  $1.2 \text{ K.m/W}$ . The ducts are to be buried at a depth of  $0.8 \text{ m}$ .

Determine the minimum conductor cross-sectional area that can be used.

### Answer

From Table 4B2,  $C_a = 1.04$ . From Table 4C3,  $C_g = 0.73$ , 3 circuits.

From Table 4B3,  $C_s = 1.18$  for a thermal resistivity of  $1 \text{ K.m/W}$  and  $C_s = 1.1$  for a thermal resistivity of  $1.5 \text{ K.m/W}$ . For a thermal resistivity of  $1.2 \text{ K.m/W}$  is found by interpolation as follows:

$$C_s = 1.18 - \frac{(1.18-1.1)}{(1.5-1)} \times (1.2-1) = 1.15$$

$$C_c = 1$$

Thus:

$$I_t = 63 \times \frac{1}{1.04} \times \frac{1}{1.15} \times \frac{1}{0.73} \text{ A} = 72.2 \text{ A}$$

From Table 4E4A Column 7 the minimum conductor cross-sectional area that can be used is found to be 16 mm<sup>2</sup> having  $I_{ta} = 75 \text{ A}$ .

## Grouped circuits not liable to simultaneous overload

Inspection of Table 4C1 of Appendix 4 of BS 7671 immediately shows that, particularly for circuits grouped in enclosures or bunched and clipped direct to a non-metallic surface, the grouping factor  $C_g$  can lead to a significant increase in the conductor cross-sectional area to be used.

However, for such grouped circuits, BS 7671 in item 5.1.2 and 6.2.2 of the Preface to the tables of conductor current-carrying capacities offers a method of limiting increases in conductor cross-sectional areas – **provided that the grouped circuits are not liable to simultaneous overload**.

This method consists of calculating  $I_t$  from:

$$I_t = \frac{I_b}{C_a C_i C_g C_c} \text{ A}$$

and then calculating  $I_t$  from:

$$I_t = \frac{I_n}{C_a C_i} \sqrt{\frac{I_n^2}{C_c^2} + 0.48 I_b^2 \left( \frac{1 - C_g^2}{C_g^2} \right)} \text{ A}$$

Whichever is the greater of the two values of  $I_t$  so obtained is then used when inspecting the appropriate table of conductor current-carrying capacities to establish the conductor cross-sectional area having an actual tabulated current-carrying capacity ( $I_{ta}$ ) equal to or greater than that value of  $I_t$ .

Figures 1.1 and 1.2 have been developed as a convenient design aid, for the conditions where  $C_c = 1$ , and are used in the following manner.

For a particular case, the values of  $C_g$  and  $I_b/I_n$  are known and Figure 1.1 immediately shows which of the two expressions gives the higher value of  $I_t$ .

Figure 1.2, by using either the broken line (but see comment in Example 1.17) or the appropriate curve from the family of curves, gives the value of the reduction factor  $F1$ . As indicated, this factor  $F1$  is applied as a multiplier to  $I_n/C_a C_i C_g$  to obtain  $I_t$  which, as before, is used to determine the minimum conductor cross-sectional area that can be tolerated. Thus Figure 1.2 also gives a very rapid indication as to whether or not it is worthwhile taking advantage of this particular option.

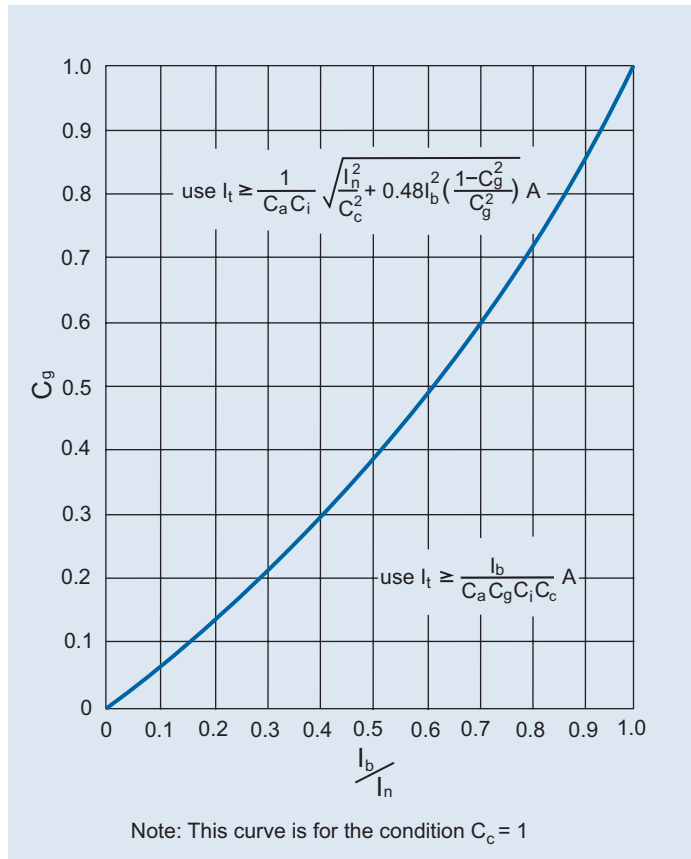

**Figure 1.1** Grouped circuits protected by HBC fuses or mcbs and not subject to simultaneous overloads.

### Example 1.17

A single-phase circuit having  $I_b = 26 \text{ A}$  is protected by a 32 A BS 88 ‘gG’ fuse and is wired in single-core 70°C thermoplastic insulated non-sheathed cables having copper conductors. It is installed with six other similar circuits in conduit on a wall in a location where the expected ambient temperature is 45°C.

What is the minimum conductor cross-sectional area that can be used if the circuits are not subject to simultaneous overload?

### Answer

From Table 4C1,  $C_g = 0.54$ . From Table 4B1,  $C_a = 0.79$ ,  $C_i = 1$ ,  $C_c = 1$ .

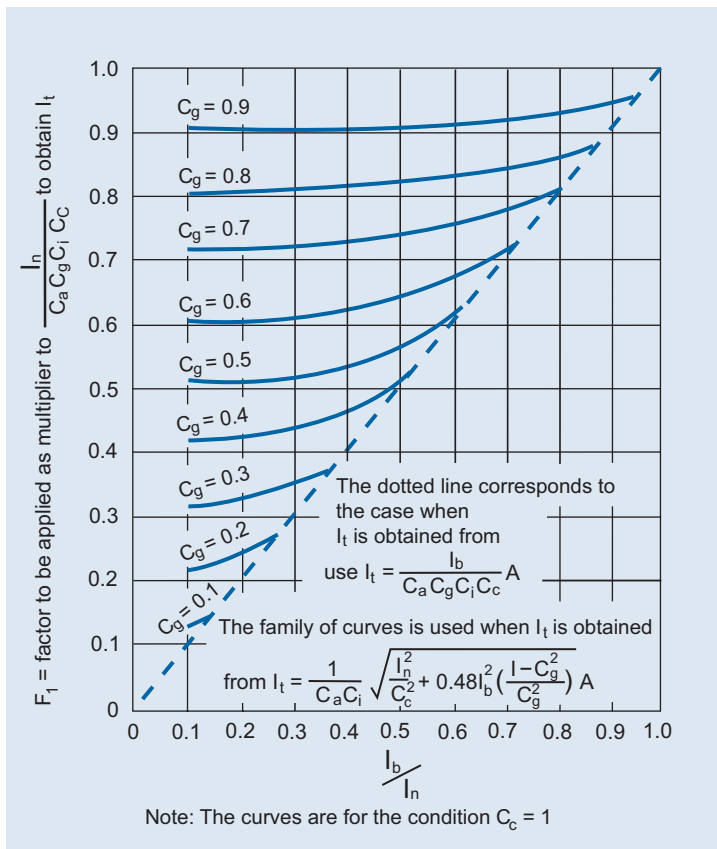

**Figure 1.2** Reduction factor to be applied for grouped circuits protected by HBC fuses or mcbs and not subject to simultaneous overloads.

$$\frac{I_b}{I_n} = \frac{26}{32} = 0.813$$

From Figure 1.1 for  $I_b/I_n = 0.813$  and  $C_g = 0.54$  it is found that the expression to use to determine  $I_t$  is:

$$I_t = \frac{I_b}{C_a C_g C_c} \text{ A} = \frac{26}{0.79 \times 0.54 \times 1} \text{ A} = 60.9 \text{ A}$$

Note that in such cases there is no point in using the dotted line in Figure 1.2 to determine the 'reduction factor' because this is simply the ratio  $I_b/I_n$ .

Inspection of Table 4D1A Column 4 indicates that the minimum conductor cross-sectional area that can be used is 16mm<sup>2</sup> having  $I_{ta} = 76$ A. In this particular case, had the circuits been subject to simultaneous overload,  $I_t$  would have been given by:

$$I_t = \frac{I_n}{C_a C_g C_c} A = \frac{32}{0.79 \times 0.54 \times 1} = 75 \text{ A}$$

One could still have used a 16 mm<sup>2</sup> conductor area, so no advantage has been gained because the circuits were not subject to simultaneous overload.

### Example 1.18

Eight similar three-phase circuits are wired in 90°C thermosetting insulated multicore cables having copper conductors, these being bunched and clipped direct.  $t_a = 50^\circ\text{C}$ ,  $I_b = 34 \text{ A}$  and  $I_n = 40 \text{ A}$ , the protection against overcurrent being provided by miniature circuit breakers.

If it can be assumed that the circuits are not subject to simultaneous overload, what is the minimum conductor cross-sectional area that can be used?

### Answer

From Table 4C1,  $C_g = 0.52$ . From Table 4B1,  $C_a = 0.80$ ,  $C_i = 1$ ,  $C_c = 1$ .

$$\frac{I_b}{I_n} = \frac{34}{40} = 0.85$$

For that value of  $I_b/I_n$  and  $C_g = 0.52$ , from Figure 1.1 it is found that the expression to determine  $I_t$  is:

$$I_t = \frac{I_b}{C_a C_g C_c} A = \frac{34}{0.80 \times 0.52 \times 1} A = 81.7 \text{ A}$$

From Table 4E2A Column 7 it is then found that the minimum conductor cross-sectional area to use is 16 mm<sup>2</sup> having  $I_{ta} = 96 \text{ A}$ .

In this case some advantage has been gained because if one assumed that the circuits were subject to simultaneous overload,  $I_t$  would have been given by:

$$I_t = \frac{I_n}{C_a C_g C_c} A = \frac{40}{0.80 \times 0.52 \times 1} A = 96.2 \text{ A}$$

and it would have been found that the minimum conductor cross-sectional area would be 25 mm<sup>2</sup>.

For grouped circuits protected by semi-enclosed fuses to BS 3036 which are not liable to simultaneous overload, a similar method to that just described can be used, except that  $C_c = 0.725$ .

One first has to calculate, as before,  $I_t$  from:

$$I_t = \frac{I_b}{C_a C_i C_g} A$$

and then from:

$$I_t = \frac{1}{C_a C_i} \sqrt{\frac{I_n^2}{C_c^2} + 0.48 I_b^2 \left( \frac{1 - C_g^2}{C_g^2} \right)} \text{ A}$$

Whichever is the greater of the two values obtained is then used when inspecting the appropriate table of conductor current-carrying capacities to establish the conductor cross-sectional area having an actual tabulated current-carrying capacity ( $I_{ta}$ ) equal to or greater than that value of  $I_t$ .

Figures 1.3 and 1.4 have been developed as a convenient design aid, similar to Figures 1.1 and 1.2 but for circuits protected by semi-enclosed fuses.

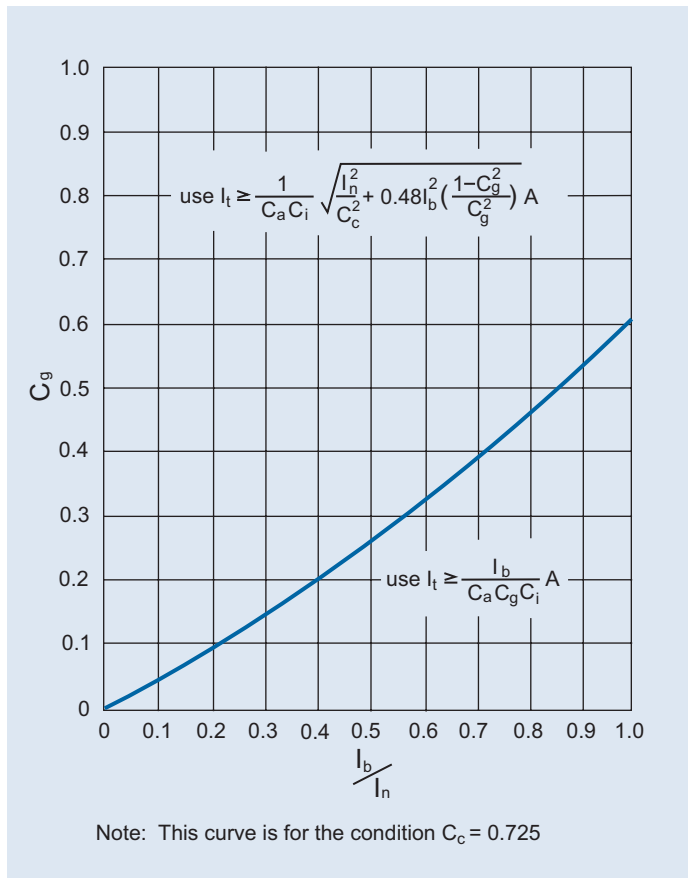

**Figure 1.3** Grouped circuits protected by semi-enclosed fuses to BS 3036 and not subject to simultaneous overloads.

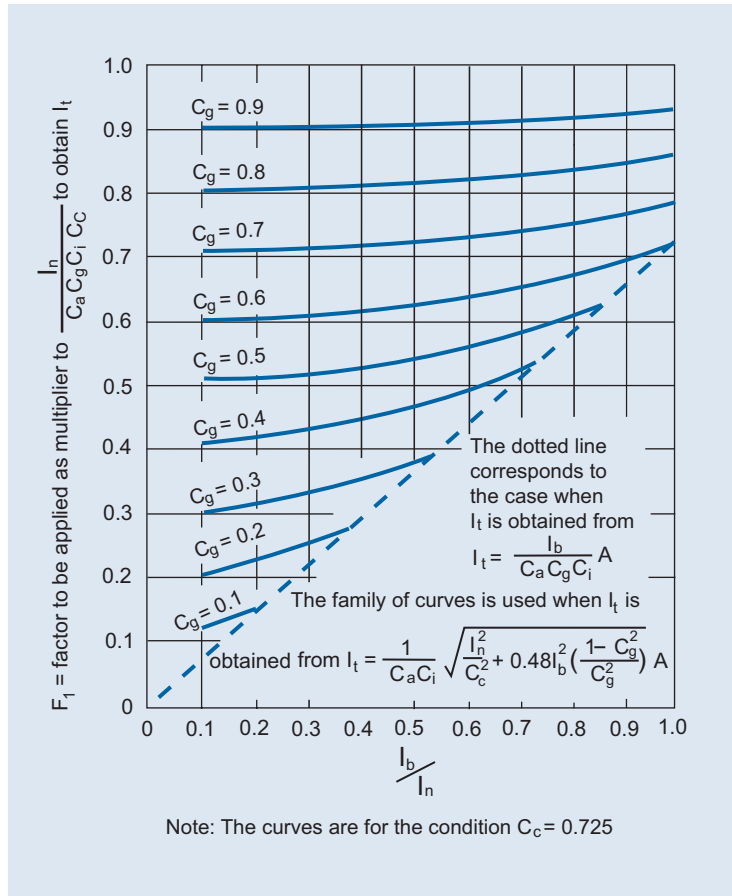

**Figure 1.4** Reduction factor to be applied for grouped circuits protected by semi-enclosed fuses to BS 3036 and not subject to simultaneous overloads.

**Example 1.19**

Seven similar single-phase circuits having  $I_b = 25\text{ A}$  are each protected against both overload and short circuit by a 30 A BS 3036 semi-enclosed fuse. Two-core 70°C thermoplastic insulated and sheathed non-armoured cables are used, the circuits being bunched and clipped direct to a wall and  $t_a = 35^\circ\text{C}$ .

What is the minimum conductor cross-sectional area that can be used if it can be assumed that the circuits are not liable to simultaneous overload?

**Answer**

From Table 4C1,  $C_g = 0.54$ . From Table 4B1,  $C_a = 0.94$ ,  $C_i = 1$ .

$$\frac{I_b}{I_n} = \frac{25}{30} = 0.83$$

From Figure 1.3 for  $I_b/I_n = 0.83$  and  $C_g = 0.54$  it is seen that  $I_t$  has to be found from:

$$I_t = \frac{1}{C_a C_i} \sqrt{\frac{I_n^2}{C_c^2} + 0.48 I_b^2 \left( \frac{1 - C_g^2}{C_g^2} \right)} \text{ A}$$

From Figure 1.4 it is then found that the 'reduction factor'  $F_1$  is approximately 0.65, so that:

$$I_t = \frac{F_1 \times I_n}{C_c \times C_g \times C_a} \text{ A} = \frac{0.65 \times 30}{0.725 \times 0.54 \times 0.94} \text{ A} = 53 \text{ A}$$

From Table 4D2A Column 6 the minimum conductor cross-sectional area that can be used is found to be 10 mm<sup>2</sup> having  $I_{ta} = 63 \text{ A}$ .

In those cases where there is very little difference between  $I_t$  and  $I_{ta}$  it would be advisable to use the actual formula as a check. In the present case there is no need to do this, but  $I_t$  so obtained would have been found to be 50.9 A.

BS 7671 offers another way of effecting some reduction in the cross-sectional areas of grouped cables as indicated in Note 9 to Table 4C1.

Normally a group of  $N$  loaded cables require a grouping correction factor of  $C_g$  applied to the actual tabulated current-carrying capacity ( $I_{ta}$ ). However, if  $M$  cables of that group are known to be carrying currents not greater than  $0.3 C_g I_{ta} \text{ A}$ , the other cables can be sized by using the grouping correction factor corresponding to  $(N - M)$  cables.

## Circuits in low ambient temperatures

All the examples so far, except those for buried cables, have concerned an ambient temperature of 30°C or greater. Consider now the case where the expected ambient temperature is less than 30°C (i.e. is less than the reference ambient temperature).

Table 4B1 of BS 7671 gives ambient temperature correction factors principally for ambient temperatures exceeding 30°C. These factors are based on the fact that with such ambient temperatures the limiting parameter is the maximum normal operating temperature for the type of cable insulation concerned and are given by:

$$C_a = \sqrt{\left( \frac{t_p - t_a}{t_p - 30} \right)}$$

These factors therefore apply if the protective device is providing overload protection with or without short circuit protection or is providing short circuit protection only.

For ambient temperatures below 30°C, however, it will be found that the limiting parameter is now the maximum tolerable temperature under overload conditions ( $t_o$ ) where:

**Table 1.4** Correction factors for low ambient temperatures.

Type of cable insulation	Function of overcurrent protective device	Ambient temperature (°C)					
		0	5	10	15	20	25
70°C thermoplastic	Overload with or without short circuit protection	1.17	1.14	1.12	1.09	1.06	1.03
	Short circuit protection only	1.32	1.27	1.22	1.17	1.12	1.06
90°C thermosetting	Overload, with or without short circuit protection	1.11	1.09	1.07	1.05	1.04	1.02
	Short circuit protection only	1.22	1.19	1.15	1.12	1.08	1.04

$$t_o = t_r + 1.45^2(t_p - t_r)^\circ\text{C}$$

and  $C_a$  is then given by:

$$C_a = \frac{1}{1.45} \sqrt{\left( \frac{t_o - t_a}{t_p - 30} \right)}$$

It follows from the foregoing that at these low ambient temperatures, the ambient temperature correction factors to be used when the overcurrent protective device is providing overload protection will be different to those if it is providing only short circuit protection.

Table 1.4 gives the ambient temperature correction.

The ambient temperature correction factors given in Table 1.4 are used in exactly the same way as those given in Table 4B1 of BS 7671.

Where 90°C thermosetting insulated cables are connected to equipment or accessories designed for a maximum temperature of 70°C, the current-carrying capacity of an equivalent thermoplastic cable should be used for the thermosetting cable. Where this leads to a larger conductor size being selected, the actual operating temperature at the terminals will be lower. Advantage can still be taken of the higher overload and short circuit capacity of the 90°C thermosetting insulated cable.

### Example 1.20

Four similar three-phase circuits are run in multicore 70°C thermoplastic insulated non-armoured cables having aluminium conductors laid in flush floor trunking (Installation Method 51).

If each circuit is protected against both overload and short circuit by 63A BS 88–2.2 ‘gG’ fuses and  $t_a = 10^\circ\text{C}$ , what is the minimum conductor cross-sectional area that can be used?

### Answer

From Table 4A2 the Reference Method is Method B.

From Table 4C1,  $C_g = 0.65$ . From Table 1.4 above,  $C_a = 1.12$ .

Thus:

$$I_t = 63 \times \frac{1}{0.65} \times \frac{1}{1.12} \text{ A} = 86.5 \text{ A}$$

From Table 4H2A Column 5 the minimum conductor cross-sectional area that can be used is found to be  $50 \text{ mm}^2$ , having  $I_{ta} = 92 \text{ A}$ .

### Grouped ring circuits

A problem frequently encountered in practice is that of grouped ring circuits. For such a case:

$$I_{ta} \geq I_n \times \frac{1}{C_r} \times \frac{1}{C_a} \times \frac{1}{C_c} \text{ A}$$

where:

$C_a$  is the ambient temperature correction factor;

$C_r$  is the ring circuit grouping factor;

$C_c$  is the factor to take account of the overload protection.

If, as may happen, the grouped circuits are embedded in thermal insulation, the factor  $C_i$  also applies and then:

$$I_{ta} \geq I_n \times \frac{1}{C_r} \times \frac{1}{C_a} \times \frac{1}{C_i} \times \frac{1}{C_c} \text{ A}$$

Note that the equation applies equally to circuits protected by BS 3036 semi-enclosed fuses and to those protected by high-blow current (HBC) fuses or mcbs.

On the assumption that in each of the grouped circuits there is a 67 : 33 split, between the two legs of the ring, in the total load current, the values of  $C_r$  given in Table 1.5 apply.

**Table 1.5** Correction factors for grouped ring circuits

Number of ring circuits	1	2	3	4	5	6	7	8	9	10
$C_r$	1.5	1.19	1.03	0.94	0.87	0.82	0.77	0.74	0.71	0.69

**Example 1.21**

Eight single-phase ring circuits are grouped in a common trunking. It is intended to use two-core (with cpc) 70°C thermoplastic insulated and sheathed flat cables having copper conductors.

If  $t_a = 40^\circ\text{C}$  and each circuit is to be protected by a 32 A mcb, what is the minimum conductor cross-sectional area that can be used?

**Answer**

From Table 1.5 earlier,  $C_r = 0.74$ . From Table 4B1,  $C_a = 0.87$ . Also  $C_c = 1$ .

Thus:

$$I_t = 32 \times \frac{1}{0.74} \times \frac{1}{0.87} \text{ A} = 49.7 \text{ A}$$

Because Table 4D5A does not include current-carrying capacities for flat twin and earth cables in trunking, Table 4D2A has to be consulted. From Column 4 of this table it is found that the minimum conductor cross-sectional area that can be used is  $10 \text{ mm}^2$  having  $I_{ta} = 52 \text{ A}$ .

**Motor circuits subject to frequent stopping and starting**

Regulation 552.1.1 requires that where a motor is intended for intermittent duty and for frequent stopping and starting, account shall be taken of any cumulative effects of the starting periods upon the temperature rise of the equipment of the circuit. That equipment, of course, includes the cables feeding the motor.

When motors are regularly restarted soon after they have been stopped the cables supplying the motor may not have time to cool to close to the ambient temperature, this time being anything from about 20 minutes to several hours depending on their size and the method of installation.

Furthermore, starting currents (for direct-on-line starting) can be between 5 and 8 times the full load current.

The calculation of any accurate factor to take account of frequent stopping and starting is complex and requires that information is provided on:

- (a) the actual magnitude of the starting current;
- (b) the duration of, and rate of decay, of the starting current;
- (c) the full load current;
- (d) the first choice cable size to calculate its time constant;
- (e) the time intervals between stopping and starting.

It is **suggested** that the cable cross-sectional area is chosen on the basis of its current-carrying capacity being 1.4 times the full load current.

**Example 1.22**

A 7.5 kW 230 V single-phase motor is subject to frequent stopping and starting. The cable supplying the motor via a direct-on-line starter is two-core non-armoured cable having 90°C thermosetting insulation and copper conductors, clipped direct.

If the ambient temperature is 50°C, what should be the conductor cross-sectional area?

**Answer**

The full load current is:

$$\frac{7.5 \times 1000}{230} \text{ A} = 32.6 \text{ A}$$

The conductor current-carrying capacity should therefore be at least  $1.4 \times 32.6 \text{ A} = 45.6 \text{ A}$ .

As the ambient temperature is 50°C, from Table 4B1 (assuming the circuit overcurrent protective device is other than a BS 3036 semi-enclosed fuse),  $C_a$  is found to be 0.82.

The cross-sectional area of the conductor should therefore have  $I_{ta}$  of at least  $45.6/0.82 \text{ A} = 55.6 \text{ A}$ .

From Table 4E2A Column 6 it is found that the minimum conductor cross-sectional area to use is  $6 \text{ mm}^2$  having  $I_{ta} = 58 \text{ A}$ .

Due account has to be taken of the motor efficiency and motor power factor where these are known.

**Example 1.23**

A 400 V three-phase motor has a rating of 15 kW at a power factor of 0.8 lagging, the efficiency being 90%.

If this motor is subject to frequent stopping and starting and it is intended to use a multicore armoured 90°C thermosetting insulated cable having copper conductors, installed in free air, what should be their cross-sectional area when  $t_a = 35^\circ\text{C}$ ?

**Answer**

The full load current of the motor is:

$$\frac{15 \times 1000}{0.8 \times 0.9 \times \sqrt{3} \times 400} \text{ A} = 30 \text{ A (per phase)}$$

The conductor current-carrying capacity should therefore be at least:

$$1.4 \times 30 \text{ A} = 42 \text{ A}$$

As the ambient temperature is 35°C, from Table 4B1,  $C_a$  is found to be 0.96.

The cross-sectional area of the conductors should therefore have  $I_{ta}$  of at least:

$$42/0.96 \text{ A} = 43.8 \text{ A}$$

From Table 4E4A Column 5 it is found that the minimum conductor cross-sectional area is  $4 \text{ mm}^2$  having  $I_{ta} = 44 \text{ A}$ .

Note that in this example no mention is made of the nominal current rating of the overcurrent protective device for the motor circuit. The omission is deliberate because that device, in very many motor circuits, is providing short circuit protection only. Overload protection is provided by, for example, thermal overload relays in the motor starter. The nominal current rating of the overcurrent protective device in the motor circuit and its operating characteristics must be such as to provide adequate short circuit protection to the circuit conductors (i.e. give compliance with the adiabatic equation in Regulation 434.5.2), but not cause disconnection of the motor circuit because of high starting currents.

## Circuits for star-delta starting of motors

Another problem associated with motors is the current demand when star-delta starting is used. With star-delta starters, six conductors (two per phase) are required between the starter and the motor, the star or delta connections being made in the starter.

During the running condition, the current carried by each of the six cables is  $1/\sqrt{3}$  times that of the supply cables to the starter (the connection being delta). If the motor cables are not grouped they require a current-carrying capacity 58% that of the supply cables. In practice it is far more likely that the motor cables are grouped together. Therefore the grouping correction factor ( $C_g$ ) for two circuits applies and the required current-carrying capacity for the motor cables becomes 72% that for the supply cables, assuming the cables are either enclosed or bunched and clipped to a non-metallic surface.

If a delta-connected motor is started direct-on-line the starting current may be between 5 and 8 times the full load current depending on the size and design of that motor. When star-delta starting is used, the current taken from the supply is one-third of that taken when starting direct on line. Hence the starting current in star may be between 1.67 and 2.67 times the full load current. During the starting period, because the star connection is used, the current in each of the motor cables equals that in the supply cables.

Because the starting current is only carried for a short period, advantage can be taken of the thermal inertia of the cables and the cables chosen because their running condition will be satisfactory for the starting current.

### Example 1.24

A 400 V three-phase 20 kW motor has a power factor of 0.86 lagging and an efficiency of 90%. Star-delta starting is to be used. The supply cables to the starter are single-core  $90^\circ\text{C}$  thermosetting insulated (copper conductors) in conduit. The motor cables from the starter are also single-core thermosetting insulated (copper conductors) and in another length of conduit.

What is the minimum conductor cross-sectional area for both circuits if  $t_a = 30^\circ\text{C}$ ?

**Answer**

$$\text{The line current} = \frac{20 \times 1000}{\sqrt{3} \times 400 \times 0.86 \times 0.90} \text{ A} = 37.3 \text{ A}$$

There are no correction factors to be applied.

From Table 4E1A Column 5, it is found that the minimum conductor cross-sectional area for the supply cables is 6 mm<sup>2</sup> having  $I_{ta} = 48 \text{ A}$ .

For the cables from the starter to the motor, each cable carries:

$$\frac{37.3}{\sqrt{3}} \text{ A} = 21.5 \text{ A}$$

But now it is necessary to apply the grouping factor for two circuits, which from Table 4C1 is 0.8. Thus:

$$I_t = \frac{21.5}{0.8} \text{ A} = 26.9 \text{ A}$$

Again from Table 4E1A Column 5 it is found that these cables can be of 2.5 mm<sup>2</sup> cross-sectional area, having  $I_{ta} = 28 \text{ A}$ .

As already stated, although during starting the cables between the motor and the starter may be carrying a current of  $37.3 \times 2.67 \text{ A} (= 99.6 \text{ A})$ , the time the motor is held in star will generally be less than the time taken for these cables to reach the maximum permitted normal operating temperature.

**Change of parameters of already installed circuits**

The occasion may arise, for example when there is a change of tenancy of the premises concerned or it is intended to change the load or other circuit details, that the user wishes to determine whether an already installed cable will be adequate. In such cases the following method should be used.

The type of cable and its cross-sectional area are established so that the relevant table in Appendix 4 of BS 7671 and the appropriate column in that table are identified. From that table and column,  $I_{ta}$  is obtained.

Then determine the product:

$$I_{ta} \times C_a \times C_g \times C_1 \times C_c \text{ A.}$$

Denote this product by  $I_{tc} \text{ A}$ .

The cable concerned could therefore be used:

- (a) for a circuit protected against both overload and short circuit by an HBC fuse or an mcb having a nominal current rating not greater than  $I_{tc} \text{ A}$ , and when the design current ( $I_b$ ) of the circuit is less than that nominal current rating; **or**

- (b) for a circuit only protected against short circuit by an HBC fuse or mcb where the design current of the circuit is not greater than  $I_{tc}$  A. The nominal current rating of the device can be greater than  $I_{tc}$  (see Regulation 434.5.1) and is determined by the load characteristics together with the need to comply with Regulation 434.5.2.

If it is intended to use semi-enclosed fuses to BS 3036 then:

$$I_{tc} = I_{ta} \times C_a \times C_g \times C_i \times 0.725 A$$

but **only** if it is intended that the fuses are to give overload protection, with or without short circuit protection. In the unlikely event that such a fuse is intended to give only short circuit protection then the 0.725 factor is **not** used to determine  $I_{tc}$ .

The symbol  $I_{tc}$  has been used here in an attempt to clarify a point which sometimes causes confusion. When the overcurrent protective device is other than a semi-enclosed fuse to BS 3036,  $I_{tc}$  has exactly the same identity as what is termed in BS 7671 the current-carrying capacity for continuous service under the particular installation conditions concerned and denoted by  $I_z$ .

When the overcurrent protection device is a semi-enclosed fuse to BS 3036,  $I_z$  is given by:

$$I_z = I_{ta} \times C_a \times C_g \times C_i A,$$

i.e. exactly the same expression as that for HBC fuses and mcbs. In other words, the effective current-carrying capacity of a conductor is totally independent of the type of overcurrent protective device associated with that conductor.

The factor 0.725 is only applied when determining the nominal current of a semi-enclosed fuse that can be used for a given conductor to take account of the higher fusing factor of such a fuse.

### Example 1.25

An existing cable for a three-phase circuit is multicore non-armoured 70°C thermoplastic insulated having copper conductors of 25 mm<sup>2</sup> cross-sectional area and is installed with five other similar cables in trunking.

What is the maximum nominal current of 'gG' fuses to BS 88–2.2 that can be used to protect this cable against both overload and short circuit if  $t_a = 50^\circ\text{C}$ ?

### Answer

From Table 4D2A Column 5,  $I_{ta} = 80 \text{ A}$ .

From Table 4C1,  $C_g = 0.57$  (there being a total of six circuits). From Table 4B1,  $C_a = 0.71$ .

As  $C_i = 1$ ,

$$I_{tc} = 80 \times 0.57 \times 0.71 \text{ A} = 32.4 \text{ A}.$$

From the standard nominal current ratings for BS 88–2.2 fuses the maximum that can be used is 32 A. The design current  $I_b$  also must not exceed 32 A.

**Example 1.26**

An existing cable for a three-phase circuit is multicore armoured having 90°C thermosetting insulation and copper conductors of 35 mm<sup>2</sup> cross-sectional area. It is clipped direct and is not bunched with any other cable.

If  $t_a = 10^\circ\text{C}$  and it is intended to protect the cable against short circuit current only, using HBC fuses, what is the maximum design current that can be tolerated?

**Answer**

From Table 1.4 of this Chapter,  $C_a = 1.15$ . Also  $C_g = 1$  and  $C_i = 1$ . From Table 4E4A Column 3,  $I_{ta} = 154\text{A}$ .

Then:

$$I_{tc} = 154 \times 1.15\text{A} = 177\text{A}.$$

The maximum value of  $I_b$  therefore is 177 A.

The nominal current rating of the HBC fuse may be greater than 177 A. It will be determined by the load characteristics and will possibly be limited by the need to comply with Regulation 434.5.2.

**Example 1.27**

An existing cable is a two-core flat 70°C thermoplastic insulated cable having copper conductors of 16 mm<sup>2</sup> which is clipped direct, bunched with four other similar cables.

If  $t_a = 40^\circ\text{C}$  and it is intended to protect the cable using a BS 3036 semi-enclosed fuse against overload, what is the maximum nominal rating that fuse can have?

**Answer**

From Table 4D5A, Column 6,  $T_{ta} = 85\text{A}$ . From Table 4C1,  $C_g = 0.60$ . From Table 4B1,  $C_a = 0.87$ .

Thus:

$$I_{tc} = 85 \times 0.60 \times 0.87 \times 0.725\text{A} = 32.2\text{A}$$

The maximum nominal current rating of the semi-enclosed fuse is therefore 30 A.

The design current of the circuit also must not exceed 30 A.

**Example 1.28**

An existing cable is an armoured multicore cable having aluminium conductors of 70 mm<sup>2</sup> cross-sectional area and 90°C thermosetting insulation. It is clipped direct to a non-metallic surface, not grouped with the cables of other circuits and  $t_a = 50^\circ\text{C}$ . The three-phase equipment fed by this cable is to be changed for equipment having a much higher kW rating and it is proposed to run a similar cable in parallel with that existing.

If overcurrent protection (both overload and short circuit) is to be provided by BS 88–2.2 ‘gG’ fuses, what is the maximum nominal rating of those fuses and the maximum load current for the circuit?

### Answer

From Table 4J4A, Column 3,  $I_{ta} = 174 \text{ A}$ . From Table 4B1,  $C_a = 0.82$ .

Assuming that the additional cable will be touching or very close to the original cable it is also necessary to apply the appropriate grouping factor,  $C_g$ .

From Table 4C1,  $C_g = 0.85$ .

Thus:

$$I_{tc} = 174 \times 0.82 \times 0.85 \text{ A} = 121 \text{ A}$$

As there are two identical cables in parallel this value has to be doubled, i.e.  $I_{tc} = 242 \text{ A}$ .

From the standard nominal ratings for BS 88–2.2 ‘gG’ fuses it is found that the maximum that can be used is 200 A and this is also the maximum value of  $I_b$  that can be tolerated for the circuit.

## Admixtures of cable sizes in enclosures

Last, but far from least in this chapter the problem of mixed cable sizes and loads in trunking or other cable enclosures is considered.

The table of grouping correction factors (Table 4C1) in BS 7671, as indicated in Note 1 to that table, is applicable only to groups of cables where the cables are all of a similar size and are equally loaded. For this reason all the examples so far given in this chapter have concerned such groups but in practice it is infinitely more likely that trunking or conduit will contain cables of various sizes and with different loadings.

Where the range of sizes in a particular enclosure is not great, using the appropriate grouping correction factor from Table 4C1 can be justified. Where a wide range of sizes is accommodated in an enclosure, however, using the Table 4C1 correction factor can lead to oversizing the large cables but undersizing of the small cables.

The following method is based on one that was developed by Mr N.S. Bryant when he was with Pirelli General plc and put forward by him at an IEE discussion meeting in March 1984. There are six steps in the method and, for the purpose of illustration, after the description of each step the values for the specific example chosen are given.

### Example 1.29

It is intended to run in 75 mm × 50 mm trunking the following circuits:

Circuit 1	Three-phase circuit $I_b = 60 \text{ A}$
Circuit 2	Three-phase circuit $I_b = 50 \text{ A}$
Circuit 3	Single-phase circuit $I_b = 40 \text{ A}$
Circuit 4	Single-phase circuit $I_b = 30 \text{ A}$
Circuit 5	Single-phase circuit $I_b = 5 \text{ A}$

Circuit 6	Single-phase circuit	$I_b = 5 \text{ A}$
Circuit 7	Single-phase circuit	$I_b = 5 \text{ A}$

The expected ambient temperature is 30°C. Determine the conductor cross-sectional areas, when single-core 70°C thermoplastic insulated cables having copper conductors are used for all the circuits and check that they are thermally adequate.

### Answer

#### Step 1

Establish the conductor cross-sectional areas based on voltage drop requirements or by experience or by applying a single grouping correction factor.

Assume it is decided to use the following cables:

Circuit 1	3 cables	35 mm <sup>2</sup>
Circuit 2	3 cables	35 mm <sup>2</sup>
Circuit 3	2 cables	25 mm <sup>2</sup>
Circuit 4	2 cables	25 mm <sup>2</sup>
Circuit 5	2 cables	1.5 mm <sup>2</sup>
Circuit 6	2 cables	1.5 mm <sup>2</sup>
Circuit 7	2 cables	1.5 mm <sup>2</sup>

#### Step 2

Calculate the 'fill factor' for the chosen sizes of cable and trunking where:

$$\text{fill factor} = \frac{\text{sum of the overall cable cross-sectional areas}}{\text{internal area of the trunking}}$$

The cable cross-sectional areas are found from the cable manufacturer's data either as such or, if a cable overall diameter ( $D_c$ ) is given, by the equation:

$$\frac{\pi}{4} D_c^2 \text{ mm}^2$$

For the example, the cable cross-sectional areas are:

for 35 mm <sup>2</sup>	95 mm <sup>2</sup>
for 25 mm <sup>2</sup>	5.4 mm <sup>2</sup>
for 1.5 mm <sup>2</sup>	9.1 mm <sup>2</sup>

The sum of all the cable cross-sectional areas is:

$$(6 \times 95) + (4 \times 75.4) + (6 \times 9.1) \text{ mm}^2 = 926 \text{ mm}^2$$

The internal area of the trunking is:

$$(75 \times 50) \text{ mm}^2 = 3750 \text{ mm}^2$$

$$\text{The fill factor} = \frac{926}{3750} = 0.247$$

Note that the fill factor is **not** the same as the space factor which is used to determine whether a cable enclosure can accommodate the desired number of cables. When determining the fill factor the existence of circuit protective conductors and, in the case of balanced three-phase circuits, the neutral conductor, is ignored because they do not normally carry current.

Note that examination of steps 2, 3 and 5 reveals that it is not necessary to calculate the trunking fill factor but only to determine the area occupied by the cables. However, the advantage in calculating the fill factor is that it is a convenient value to use when tabulating values of thermal capability. If this method is to be used frequently, values of thermal capability can be calculated and tabulated for a number of different fill factors and retained for future use.

### Step 3

Find the number of cables (N) of any particular size (S mm<sup>2</sup>) which will give the same fill factor as that determined in Step 2.

It will be found that 26 cables of 10 mm<sup>2</sup> conductor cross-sectional area (overall area being 36.3 mm<sup>2</sup>) will give a fill factor of 0.252 which is sufficiently close to 0.247.

### Step 4

Calculate the thermal capability of the trunking for the fill factor, the thermal capability being given by:

$$(I_{ta} \times C_g)^2 \times N \times R \text{ watts/metre}$$

where:

$I_{ta}$  = current-carrying capacity for the conductor cross-sectional area chosen in Step 3

$C_g$  = grouping correction factor for the number of cables chosen in Step 3, i.e. for N cables

R = effective a.c. resistance per cable per metre in ohms/m.

Although some circuits are three-phase and others are single-phase, to find  $C_g$  for the 26 cables, take from Table 4C1 the value for 26/2, i.e. 13 circuits (single-phase). This value is 0.44.

Similarly to find  $I_{ta}$  use Column 4 of Table 4D1A (i.e. the column for single-phase circuits). It is found to be 57 A for 10 mm<sup>2</sup> cross-sectional area.

A very convenient way of finding R is to use:

$$\frac{\text{tabulated mV/A/m}}{1000 \times 2} \text{ ohms/m}$$

where the tabulated mV/A/m relates to single-phase circuits. From Table 4D1B it is found to be 4.4 milliohms/m for 10 mm<sup>2</sup> cross-sectional area.

Thus the thermal capability of the trunking is:

$$\frac{(57 \times 0.44)^2 \times 26 \times 4.4}{1000 \times 2} \text{ W/m} = 36 \text{ W/m}$$

### Step 5

Calculate for each actual cable size in the trunking its permitted power dissipation (P) which is given by:

$$\frac{\text{its own overall c.s.a.} \times \text{thermal capacity of trunking}}{\text{fill factor} \times \text{internal area of the trunking}} \text{ W/m}$$

So that:

$$\text{for } 35 \text{ mm}^2 \quad P = \frac{95 \times 36}{0.252 \times 3750} \text{ W/m} = 3.62 \text{ W/m}$$

$$\text{for } 25 \text{ mm}^2 \quad P = \frac{75.4 \times 36}{0.252 \times 3750} \text{ W/m} = 2.87 \text{ W/m}$$

$$\text{for } 1.5 \text{ mm}^2 \quad P = \frac{9.1 \times 36}{0.252 \times 3750} \text{ W/m} = 0.347 \text{ W/m}$$

### Step 6

Calculate for each actual cable size in the trunking, its grouped current-carrying capacity ( $I_g$ ) which is given by:

$$I_g = \sqrt{\frac{P}{R}} \text{ A}$$

where:

P is its power dissipation as calculated in Step 5

R is its resistance in ohms/m.

R is determined as before:

$$R = \frac{\text{tabulated mV/A/m}}{2 \times 1000} \text{ ohms/m}$$

using the tabulated mV/A/m for single-phase circuits, or:

$$R = \frac{\text{tabulated mV/A/m}}{\sqrt{3} \times 1000} \text{ ohms/m}$$

using the tabulated mV/A/m for three-phase circuits. (For a given conductor size the R values so obtained are the same.) So that using mV/A/m values from Table 4DIB:

$$\text{for } 35 \text{ mm}^2 \quad R = \frac{1.3}{2000} \text{ ohms/m} = 0.00065 \text{ ohms/m}$$

$$\text{for } 25 \text{ mm}^2 \quad R = \frac{1.8}{2000} \text{ ohms/m} = 0.00090 \text{ ohms/m}$$

$$\text{for } 1.5 \text{ mm}^2 \quad R = \frac{29}{2000} \text{ ohms/m} = 0.0145 \text{ ohm/m}$$

and, therefore the values of  $I_g$  are:

for circuit 1	74.6 A
for circuit 2	74.6 A
for circuit 3	56.5 A
for circuit 4	56.5 A
for circuit 5	4.9 A
for circuit 6	4.9 A
for circuit 7	4.9 A.

If these values of  $I_g$  are compared with the design currents,  $I_b$ , for the circuits it will be seen that for circuits 1, 2, 3 and 4 they are greater whereas for circuits 5, 6 and 7 they are marginally lower.

It is a matter of the personal judgement of the designer to attempt to change the proposed conductor cross-sectional area for one or more of the circuits. If it is decided to follow this course it is necessary to repeat the above procedure.

On the other hand, because there is some 'spare' current-carrying capacity in some of the circuits, it is possible to trade this off against the undersizing of the three 5 A circuits.

When the total power dissipation per metre from all the circuits is less than the thermal capacity of the trunking per metre, a cable may exceed its grouping current-carrying capacity by a factor  $F_g$  which is given by:

$$F_g = \sqrt{3.95 - (0.0295 \times \mu)}$$

where:

$$\mu = \frac{\text{total power dissipation of the cables per metre} \times 100}{\text{thermal capacity of the trunking per metre}}$$

In the present case the various actual power dissipations per cable ( $I_b^2 R$ ), calculated using the  $I_b$  values given earlier and R values from Step 6, are given in Table 1.6. The total (W/m) values relate to the circuits and are the per cable values multiplied by 3 for three-phase circuits and by 2 for single-phase circuits.

The total cable power dissipation per metre is therefore 18.6 W/m; this is less than the thermal capacity of the trunking.

**Table 1.6** Actual power dissipation

Circuit	Actual power dissipation	
	per cable (W/m)	total (W/m)
Circuit 1	2.34	7.02
Circuit 2	1.63	4.88
Circuit 3	1.44	2.88
Circuit 4	0.81	1.62
Circuit 5	0.363	0.726
Circuit 6	0.363	0.726
Circuit 7	0.363	0.726

$$\mu = \frac{18.6}{36} \times 100\% = 51.7\%$$

$$F_g = \sqrt{3.95 - (0.0295 \times 51.7)} = 1.56$$

Hence the maximum current which could be carried by the light current circuits is:

$$1.56 \times 4.9 \text{ A} = 7.6 \text{ A}$$

The above example is a relatively simple one and readers wishing to have more detailed information should study ERA Reports 69–30 Parts VIII and IX in which much of the required data has been tabulated.

In those cases where the circuits concerned are subject to overload, having used the above method to determine the correct conductor cross-sectional areas from consideration of current-carrying capacity, it is then necessary to check these areas to ensure that the circuits are adequately protected against overload.

To do this the methods given earlier in this chapter are used and it becomes necessary to determine the grouping factor ( $C_g$ ) for each circuit.

This is given by:

$$C_g = \frac{I_g \times F_g}{I_{ta}}$$

where, as before:

$I_g$  = group current-carrying capacity, A (Step 6)

$F_g$  = factor (Step 6)

$I_{ta}$  = tabulated current-carrying capacity, A for a single circuit (in trunking), for the cable concerned.

## Grouping of cables having different insulation

In practice the situation may arise where cables are grouped which are of different types having different maximum permitted operating temperatures. In such cases further correction factors have to be applied to the cables having the higher maximum permitted operating temperatures so that all the cable ratings are based on the lowest such temperature of any cable in the group.

These correction factors are given in Table 1.7. For a group containing 70°C thermoplastic insulated cables and cables having 90°C thermosetting insulation, a correction factor of 0.82 should be applied to the ratings of the 90°C thermosetting cables in addition to the conventional grouping factors.

Alternatively the current ratings for all of the cables in the group can be selected from the table appropriate to the cable having the lowest maximum permitted operating temperature.

**Table 1.7** Correction factors for groups of different types of cable

Conductor maximum permitted operating temperature	Maximum permitted operating temperature			
	60°C	70°C		90°C
60°C	1	—		—
70°C	0.87	1		—
90°C	0.71	0.82		1



# 2

## Calculation of voltage drop under normal load conditions

The designer will frequently find that compliance with the voltage drop requirements is the predominant factor in determining the minimum conductor cross-sectional area that can be used for a particular circuit.

When calculating the voltage drop of a circuit the designer has the option of using the 'simple approach' or, in many cases, a more accurate design approach.

The first series of examples in this chapter illustrates the simple approach which uses the tabulated mV/A/m values given in Appendix 4 of BS 7671 directly, i.e. without taking account of conductor operating temperature or load power factor. This simple approach is a pessimistic one which sometimes leads to larger conductor cross-sectional areas than are necessary.

The second series of examples illustrates the more accurate design approach and some indication is given of where this may be used to advantage.

In general, when determining voltage drop the designer should initially use the simplified approach and only when the voltage drop indicated by this approach exceeds the desired value should the designer consider using the more accurate method described later. Where the value obtained from the simplified approach only marginally exceeds the desired value, however, the designer should recalculate using the more accurate method as this may obviate the need to increase the conductor cross-sectional area.

In some examples in this chapter a comparatively high ambient temperature is quoted. This has been done simply for illustration and it must be emphasized that in most practical cases the designer is able to assume that the expected ambient temperature will be either the reference value (30°C) or near to it.

### The simple approach

The only information needed is:

- type of cable
- the conductor cross-sectional area
- the method of installation (for a.c. circuits only)
- the circuit route length (l)
- the type of circuit (d.c., single-phase a.c. or three-phase a.c.)
- the load on the circuit.

The following factors are **not** needed:

- (a) the type and nominal current rating of the associated overcurrent protective device;
- (b) the ambient temperature;
- (c) whether the circuit is run singly or grouped with other circuits;
- (d) the power factor of the load.

For d.c. circuits using conductors of any cross-sectional area, and for a.c. circuits using conductors of 16 mm<sup>2</sup> or less cross-sectional area:

$$\text{Voltage drop} = \frac{\text{tabulated mV/A/m} \times I_b \times l}{1000} \text{ volts}$$

For a.c. circuits using conductors of 25 mm<sup>2</sup> or greater cross-sectional area:

$$\text{Voltage drop} = \frac{\text{tabulated (mV/A/m)}_z \times I_b \times l}{1000} \text{ volts}$$

Note that the tabulated (mV/A/m)<sub>z</sub> value will be found in the column appropriate to the method of installation and type of circuit but in the sub-column headed 'Z'.

Also note that it is always admissible to calculate the voltage drop using I<sub>b</sub> and not I<sub>n</sub>.

In the voltage drop tables of Appendix 4 of BS 7671 the heading used is 'Voltage drop per ampere per metre' and the tabulated values are given in millivolts. This approach does not lead to any misunderstanding and, as indicated by the two formulae above, the voltage drop can be readily determined whatever the type of circuit, using the appropriate tabulated value.

It can be argued, however, that these tabulated mV/A/m values are strictly in milliohms/m and this is the approach used throughout this book.

As shown later, in addition to their use in determining the voltage drop of a circuit, they can also be used, equally directly, to determine the resistance per metre of a circuit conductor. The resistance per metre (in milliohms/m) of a particular conductor in a single-phase or d.c. circuit is simply the tabulated mV/A/m value divided by 2 or, in a three-phase circuit, its tabulated mV/A/m value divided by  $\sqrt{3}$ .

### Example 2.1

A d.c. circuit is wired in single-core 70°C thermoplastic-insulated non-sheathed cable having copper conductors of 10 mm<sup>2</sup> cross-sectional area.

If I<sub>b</sub> = 40 A and l = 33 m what is the voltage drop?

### Answer

From Table 4DIB Column 2 the mV/A/m is found to be 4.4 milliohms/m. The voltage drop is:

$$\frac{4.4 \times 40 \times 33}{10000} \text{ V} = 5.8 \text{ V}$$

**Example 2.2**

A single-phase circuit is wired in 10 mm<sup>2</sup> two-core mineral-insulated cable having copper conductors and sheath and a thermoplastic overall covering.

If  $I_b = 65$  A and  $l = 40$  m what is the voltage drop?

**Answer**

The appropriate table of voltage drop is Table 4G1B and from Column 2 it is found that the mV/A/m is 4.2 milliohms/m.

The voltage drop is:

$$\frac{4.2 \times 65 \times 40}{1000} \text{ V} = 10.9 \text{ V}$$

**Example 2.3**

A 400 V three-phase circuit is to be wired in a four-core armoured cable having 90°C thermosetting insulation and aluminium conductors of 35 mm<sup>2</sup> cross-sectional area.

If  $I_b = 120$  A and  $l = 27$  m what is the percentage voltage drop?

**Answer**

From Table 4J4B Column 4 the (mV/A/m)<sub>z</sub> is found to be 1.95 milliohms/m.

The voltage drop is:

$$\frac{1.95 \times 120 \times 27}{1000} \text{ V} = 6.32 \text{ V}$$

The percentage voltage drop is:

$$\frac{6.32 \times 100}{400} \% = 1.58\%$$

It is frequently necessary to determine the voltage at a point of utilization of a final circuit fed from a sub-distribution board and the next example shows one method that can be used. It is necessary to assume that the distribution cable feeding the sub-distribution board is carrying the design current determined from the application of a diversity factor.

**Example 2.4**

A 230 V single-phase a.c. circuit is wired in two-core 70°C thermoplastic insulated and sheathed non-armoured cable having copper conductors. The circuit length is 20 m and  $I_b = 25$  A. The conductor cross-sectional area of this cable is 6 mm<sup>2</sup>.

This circuit is taken from a sub-distribution board which is supplied by a 400 V three-phase and neutral circuit wired in multicore 70°C thermoplastic insulated armoured cable, having copper

conductors. This cable is clipped direct to a wall. Its cross-sectional area is  $25 \text{ mm}^2$  and taking into account diversity, the distribution circuit design current is taken to be 100 A. The length of this circuit is 30 m.

What is the voltage at the point of utilization of the single-phase final circuit?

### Answer

First calculate the voltage drop in the distribution circuit.

From Table 4D4B Column 4 the  $(\text{mV}/\text{A}/\text{m})_z$  is found to be 1.5 milliohms/m.

Therefore the voltage drop is:

$$\frac{1.5 \times 100 \times 30}{1000} \text{ V} = 4.5 \text{ V}$$

Thus the line-to-line voltage is  $400 - 4.5 \text{ V} = 395.5 \text{ V}$ .

The line-to-neutral voltage is:

$$\frac{395.5}{\sqrt{3}} \text{ V} = 228.3 \text{ V}$$

The voltage drop in the final circuit is then calculated as follows:

From Table 4D2B Column 3, the  $\text{mV}/\text{A}/\text{m}$  is found to be 7.3 milliohms/m.

The voltage drop is given by:

$$\frac{7.3 \times 20 \times 25}{1000} \text{ V} = 3.65 \text{ V}$$

The voltage at the point of utilization is:

$$228.3 - 3.65 \text{ V} = 224.7 \text{ V}$$

It is accepted that in many practical cases some imbalance may occur on the three-phase side, leading to current in the neutral conductor of the distribution circuit. What the magnitude of this current could be is very difficult, and often impossible, to forecast. For this reason alone it is necessary to assume, as has been done in Example 2.4, that balanced conditions apply.

### The more accurate approach taking account of conductor operating temperature

Earlier in this chapter, when introducing the simple approach, it was stated that four particular factors were not needed. The more accurate approach, however, does require the designer to know two of those four factors, namely:

- (i) the ambient temperature
- (ii) whether the circuit is to be run singly or grouped with other circuits.

Where the load power factor is known, as will be shown later, it is sometimes of advantage to take this into account.

The tabulated  $\text{mV/A/m}$  values for conductor cross-sectional areas of  $16\text{ mm}^2$  or less and the tabulated  $(\text{mV/A/m})_r$  values for  $25\text{ mm}^2$  or greater are based on the conductor's actual operating temperature being the maximum permitted normal operating temperature for the type of cable insulation concerned, as indicated in the relevant table of current-carrying capacity.

It will be sheer coincidence if this equality between the two temperatures is obtained in practice and the most common situation is that the conductor operating temperature will be less than the maximum permitted because of compliance with Regulation 523.1.

It follows that if the designer so wishes he can use a lower value of  $\text{mV/A/m}$  or of  $(\text{mV/A/m})_r$  than the tabulated value for design purposes providing he is able to calculate first the actual operating temperature.

For circuits run singly and not totally embedded in thermally insulating material the conductor's actual operating temperature is given by:

$$t_1 = t_a + \frac{I_b^2}{I_{ta}^2}(t_p - t_r)^\circ\text{C}$$

and

$$\frac{\text{design mV/A/m}}{\text{tabulated mV/A/m}} = \frac{230 + t_1}{230 + t_p}$$

The above equations are simplifications of Equation 6 given in Clause 6.1 of Appendix 4 of BS 7671. The equation in Appendix 4 takes account of any ambient temperature factor, grouping factor and the load current in one equation.

The second equation is based on the approximate value of resistance-temperature coefficient of 0.004 per  $^\circ\text{C}$  at  $20^\circ\text{C}$  which is applicable to both copper and aluminium conductors.

### Example 2.5

A single-phase circuit is wired in two-core armoured  $70^\circ\text{C}$  thermoplastic insulated cable with  $16\text{ mm}^2$  copper conductors. The cable is clipped direct to a wall and is not grouped with other cables.

If  $I_b = 70\text{ A}$ ,  $t_a = 35^\circ\text{C}$  and  $l = 30\text{ m}$ , what is the voltage drop?

### Answer

From Table 4D4A Column 2,  $t_p = 70^\circ\text{C}$  and  $I_{ta} = 89\text{ A}$ . Also  $t_r = 30^\circ\text{C}$ .

Thus the conductor operating temperature is given by:

$$t_1 = 35 + \frac{70^2}{89^2}(70 - 30)^\circ\text{C} = 59.7^\circ\text{C}$$

From Table 4D4B Column 3, the tabulated mV/A/m is 2.8 milliohms/m. So the voltage drop is:

$$\left( \frac{230 + 59.7}{230 + 70} \right) \left( \frac{2.8 \times 70 \times 30}{1000} \right) \text{V} = 5.7 \text{ V}$$

### Example 2.6

A three-phase circuit is run in multicore sheathed and non-armoured cable having 60°C rubber insulation and flexible copper conductors of 16 mm<sup>2</sup> cross-sectional area. The cable is mounted in free air (Reference Method F) and is not grouped with other cables.

If  $t_a = 50^\circ\text{C}$ ,  $l = 20 \text{ m}$  and  $I_b = 45 \text{ A}$ , what is the voltage drop?

### Answer

From Table 4F1A Column 3,  $t_p = 60^\circ\text{C}$  and  $I_{ta} = 89 \text{ A}$ . Also  $t_r = 30^\circ\text{C}$ . Thus:

$$t_1 = 50 + \frac{45^2}{89^2} (60 - 30)^\circ\text{C} = 57.7^\circ\text{C}$$

From Table 4F2B Column 4, the tabulated mV/A/m is 2.5 milliohms/m. The voltage drop is:

$$\left( \frac{230 + 57.7}{230 + 60} \right) \left( \frac{2.5 \times 45 \times 20}{1000} \right) \text{V} = 2.23 \text{ V}$$

When a circuit is protected by a semi-enclosed fuse to BS 3036 the conductor's cross-sectional area to be used is greater than if the protective device was an HBC fuse or miniature circuit breaker (of the same current rating). It follows that the ratio  $I_b/I_{ta}$  will be less as will the actual operating temperature.

When the BS 3036 fuse is providing overload protection and the reference ambient temperature is taken to be the expected value, it can be shown that the conductor operating temperature with 70°C thermoplastic insulated cables will not exceed 51°C, or, for 90°C thermosetting insulated cables, 61.5°C.

Thus, when using semi-enclosed fuses to BS 3036, another option open to the designer is that instead of calculating the actual conductor operating temperature, the following factors may be applied as multipliers to the tabulated mV/A/m values to obtain the design values, provided the expected ambient temperature is 30°C:

70°C thermoplastic insulated cables: 0.94

90°C thermosetting insulated cables: 0.91.

In some cases it will be found that by using this option there will be no need to increase the conductor cross-sectional area from voltage drop considerations.

### Example 2.7

A single-phase circuit having  $I_b = 18 \text{ A}$  is protected by a 20 A BS 3036 semi-enclosed fuse against

overload and short circuit. The circuit is wired in 6 mm<sup>2</sup> flat 70°C thermoplastic insulated and sheathed cables having copper conductors.

If  $l = 48$  m and  $t_a = 30^\circ\text{C}$ , what is the voltage drop?

### Answer

From Table 4D2B Column 3 the mV/A/m value is 7.3 milliohms/m.

The **design** mV/A/m =  $7.3 \times 0.94$  milliohms/m = 6.862 milliohms/m.

The voltage drop is:

$$\frac{18 \times 48 \times 6.862}{1000} \text{ V} = 5.93 \text{ V}$$

### Example 2.8

A three-phase circuit having  $I_b = 40$  A is protected by 45 A BS 3036 semi-enclosed fuses against overload and short circuit. The circuit is wired in single-core non-armoured cables having 90°C thermosetting insulation and 10 mm<sup>2</sup> copper conductors in trefoil touching.

If  $l = 65$  m and  $t_a = 30^\circ\text{C}$ , what is the voltage drop?

### Answer

From Table 4E1B Column 7 the mV/A/m value is 4 milliohms/m.

The **design** mV/A/m =  $4 \times 0.91$  milliohms/m = 3.64 milliohms/m.

The voltage drop is:

$$\frac{40 \times 65 \times 3.64}{1000} \text{ V} = 9.46 \text{ V}$$

### Example 2.9

A single-phase circuit having  $I_b = 26$  A is to be protected by a 30 A BS 3036 semi-enclosed fuse against overload and short circuit. The circuit is to be wired in two-core 70°C thermoplastic insulated and sheathed non-armoured cable embedded in plaster, not grouped with other cables.

If  $l = 33$  m and  $t_a = 35^\circ\text{C}$ , what is the minimum conductor cross-sectional area that can be used and what is the voltage drop?

### Answer

From Table 4B1,  $C_a = 0.94$ . Also  $C_g = 1$  and  $C_i = 1$ .

Thus:

$$I_t = 30 \times \frac{1}{0.94} \times \frac{1}{0.725} \text{ A} = 44.0 \text{ A}$$

From Table 4D2A Column 6 it is found that the minimum conductor cross-sectional area that can be used is  $6 \text{ mm}^2$  having  $I_{ta} = 46 \text{ A}$ .

The conductor operating temperature is given by:

$$t_1 = 35 + \frac{26^2}{46^2} (70 - 30)^\circ\text{C} = 47.8^\circ\text{C}$$

From Table 4D2B Column 3 the  $\text{mV/A/m}$  is found to be  $7.3 \text{ milliohms/m}$ .

The voltage drop is:

$$\left( \frac{230 + 47.8}{230 + 70} \right) \left( \frac{7.3 \times 26 \times 33}{1000} \right) \text{V} = 5.8 \text{ V}$$

To show very rapidly the sort of advantage one can gain by taking into account conductor operating temperature, Figure 2.1 gives a family of curves of the reduction factor, i.e. the ratio of the design  $\text{mV/A/m}$  to the tabulated  $\text{mV/A/m}$  plotted against actual ambient temperature, each curve being for a particular value of  $I_b/I_{ta}$ . Figure 2.1 is for  $70^\circ\text{C}$  thermoplastic insulated cables and Figure 2.2 is for cables having  $90^\circ\text{C}$  thermosetting insulation. These reduction factors, for the larger cables, apply only to the  $(\text{mV/A/m})_r$  values and not to the  $(\text{mV/A/m})_x$  values.

The following two examples show how these figures may be used.

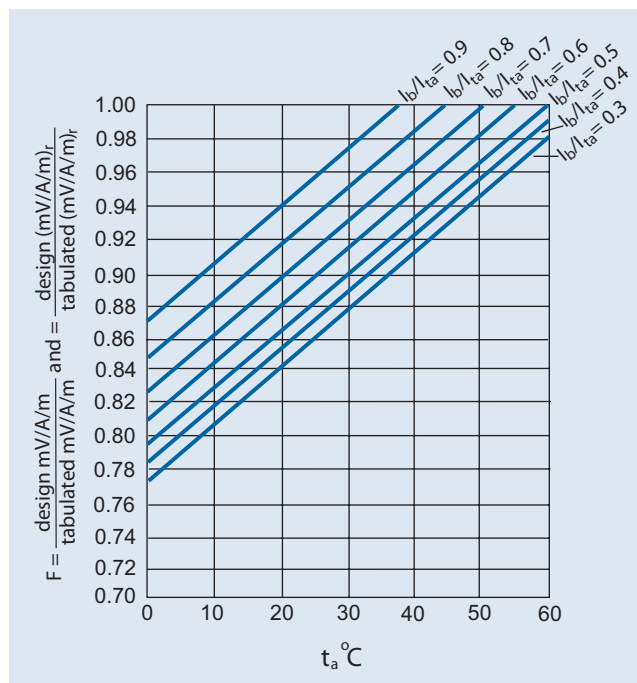

**Figure 2.1** Reduction factors for different ambient temperatures and values of  $I_b/I_{ta}$  –  $70^\circ\text{C}$  thermoplastic insulated cables – circuits run singly.

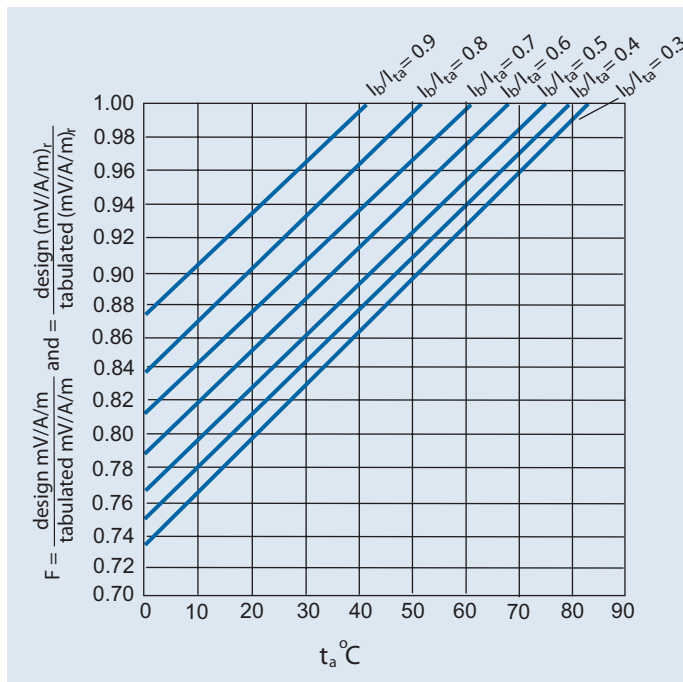

**Figure 2.2** Reduction factors for different ambient temperatures and values of  $I_b/I_{ta}$  – cables having 90°C thermosetting insulation – circuits run singly.

**Example 2.10**

A three-phase circuit having  $I_b = 35\text{A}$  is to be protected against overload by 45 A BS 1361 fuses. This circuit is to be wired in a multicore 70°C thermoplastic insulated armoured cable having copper conductors, clipped direct and not grouped with other cables.

If  $t_a = 30^\circ\text{C}$  and  $l = 55\text{ m}$ , what is the minimum conductor cross-sectional area that can be used and what is the voltage drop?

**Answer**

As  $C_a$ ,  $C_g$  and  $C_i$  do not apply:

$$I_t = I_n = 45\text{ A}$$

From Table 4D4A Column 3 it is found that the minimum conductor cross-sectional area that can be used is  $10\text{ mm}^2$  having  $I_{ta} = 58\text{ A}$  and tabulated  $\text{mV/A/m}$  of 3.8 milliohms/m (Column 4 in Table 4D4B).

Thus:

$$I_b/I_{ta} = 35/58 = 0.603$$

From Figure 2.1 for this value of  $I_b/I_{ta}$  and  $t_a = 30^\circ\text{C}$  it is found that the reduction factor (F) is 0.915.

The **design** mV/A/m is then  $0.915 \times 3.8$  milliohms/m = 3.477 milliohms/m and the voltage drop is:

$$\frac{3.477 \times 35 \times 55}{1000} \text{ V} = 6.7 \text{ V}$$

### Example 2.11

A three-phase circuit is wired in 50mm<sup>2</sup> multicore armoured cable having 90°C thermosetting insulation and aluminium conductors. It is run in free air (Reference Method F) but is not grouped with other cables.

If  $I_b = 110 \text{ A}$ ,  $t_a = 20^\circ\text{C}$  and  $l = 35 \text{ m}$ , what is the voltage drop? The power factor of the load is not known.

### Answer

From Table 4J4B Column 4,  $(\text{mV/A/m})_r = 1.40$  milliohms/m and  $(\text{mV/A/m})_x = 0.135$  milliohms/m.

From Table 4J4A Column 5,  $I_{ta} = 145 \text{ A}$ .

Thus:

$$I_b/I_{ta} = 110/145 = 0.76$$

From Figure 2.2 the reduction factor F is found to be 0.89.

Hence **design**  $(\text{mV/A/m})_r = 0.89 \times 1.40$  milliohms/m = 1.246 milliohms/m.

$$\text{'Corrected' } (\text{mV/A/m})_z = \sqrt{1.246^2 + 0.135^2} = 1.253 \text{ milliohms/m}$$

Voltage drop is:

$$\frac{1.253 \times 110 \times 35}{1000} \text{ V} = 4.82 \text{ V}$$

So far in this chapter all the examples have concerned circuits run singly, i.e. not grouped or bunched with other circuits. For grouped circuits the **simple** approach for the calculation of voltage drop is exactly the same as for single circuits and the same is true of the method of taking account of the load power factor.

### Example 2.12

Six similar single-phase circuits are installed in a common trunking. Each has  $I_b = 27 \text{ A}$  and is protected against both overload and short circuit by a 32 A mcb. The circuits are run in single-core 70°C thermoplastic insulated cables.

If  $t_a = 45^\circ\text{C}$  and  $l = 50\text{m}$ , what is the minimum conductor cross-sectional area that can be used and what is the voltage drop?

### Answer

From Table 4C1,  $C_g = 0.57$ . From Table 4B1,  $C_a = 0.79$  so that:

$$I_t = 32 \times \frac{1}{0.57} \times \frac{1}{0.79} \text{ A} = 71.1 \text{ A}$$

From Table 4D1A Column 4 it will be found that the minimum conductor cross-sectional area that can be used is  $16\text{mm}^2$  having  $I_{ta} = 76\text{A}$ .

From Table 4D1B, Column 3 the  $\text{mV/A/m}$  value for this conductor is 2.8 milliohms/m.

The voltage drop is given by:

$$\frac{2.8 \times 27 \times 50}{1000} \text{ V} = 3.78 \text{ V}$$

In this particular example, had the circuits been 230V circuits subject to a maximum voltage drop of 2.5%, i.e. of 5.8V, there would have been no need to use other than this simple approach to calculate the voltage drop.

### Example 2.13

Eight similar single-phase circuits are grouped together, clipped direct, each having  $I_b = 24\text{A}$  and protected against overload and short circuit by a 30A BS 3036 semi-enclosed fuse. The circuits are run in non-armoured  $70^\circ\text{C}$  two-core (with cpc) thermoplastic insulated and sheathed flat cables.

If  $t_a = 30^\circ\text{C}$  and  $l = 70\text{m}$ , what is the minimum conductor cross-sectional area that can be used and what is the voltage drop?

### Answer

From Table 4C1,  $C_g = 0.52$ ,  $C_a = 1$  and  $C_d = 0.725$ .

$$I_t = 30 \times \frac{1}{0.52} \times \frac{1}{0.725} \text{ A} = 79.6 \text{ A}$$

From Table 4D5A Column 6 it is found that the minimum conductor cross-sectional area that can be used is  $16\text{mm}^2$  having  $I_{ta} = 85\text{A}$ .

From Table 4D2B Column 3 the  $\text{mV/A/m}$  value is found to be 2.8 milliohms/m.

The voltage drop is given by:

$$\frac{2.8 \times 24 \times 70}{1000} \text{ V} = 4.7 \text{ V}$$

The next example concerns cables in parallel.

### Example 2.14

A three-phase circuit comprises two multicore non-armoured 70°C thermosetting insulated cables having copper conductors of 185 mm<sup>2</sup> cross-sectional area connected in parallel.

If  $I_b = 550$  A and  $l = 60$  m, what is the voltage drop?

### Answer

From Table 4D2B Column 4 the  $(\text{mV/A/m})_z$  value is found to be 0.25 milliohms/m.

The voltage drop line-to-line is given by:

$$\frac{550 \times 60 \times 0.25}{2 \times 1000} \text{ A} = 4.13 \text{ V}$$

Note the introduction of the factor '2' in the denominator, because there are two cables in parallel.

Now consider the more accurate approach for grouped circuits.

When the overcurrent protective devices are BS 3036 semi-enclosed fuses, the most practical way of obtaining a more accurate calculated value of the voltage drop is to use the factor of 0.94. This accounts for the fact that the conductor temperature does not exceed 51°C if the cables are 70°C thermoplastic insulated or the factor 0.91 if the cables are 90°C thermosetting insulated.

When the overcurrent protection is provided by HBC fuses or mcbs **and** the expected ambient temperature is 30°C or greater, the actual conductor temperature is given by:

$$t_1 = t_p - \left( C_a^2 C_g^2 - \frac{I_b^2}{I_{ta}^2} \right) (t_p - 30)^\circ\text{C}$$

and

$$\frac{\text{design mV/A/m}}{\text{tabulated mV/A/m}} = \frac{230 + t_1}{230 + t_p}$$

For conductor cross-sectional areas greater than 16 mm<sup>2</sup> the above relationship applies only to the resistance component of the voltage drop, i.e.

$$\frac{\text{design } (\text{mV/A/m})_r}{\text{tabulated } (\text{mV/A/m})_r} = \frac{230 + t_1}{230 + t_p}$$

but the design  $(\text{mV/A/m})_x = \text{tabulated } (\text{mV/A/m})_x$  because reactance is not influenced by temperature.

**Example 2.15**

Five similar single-phase circuits are grouped together, clipped direct, and run in two-core non-armoured 70°C thermoplastic insulated and sheathed cables having copper conductors of 16 mm<sup>2</sup> cross-sectional area. Each circuit has  $I_b = 29$  A and is protected against short circuit currents only by a BS 88-2.2 'gG' fuse.

If  $t_a = 50^\circ\text{C}$  and  $l = 70$  m, what is the voltage drop?

**Answer**

From Table 4C1,  $C_g = 0.60$ . From Table 4B1,  $C_a = 0.71$  and  $t_p = 70^\circ\text{C}$ .

From Table 4D2A Column 6,  $I_{ta} = 85$  A.

$$t_1 = 70 - \left( 0.71^2 \times 0.60^2 - \frac{29^2}{85^2} \right) (70 - 30)^\circ\text{C}$$

$$= 70 - 2.6^\circ\text{C}$$

$$= 67.4^\circ\text{C}$$

From Table 4D2B Column 3, mV/A/m = 2.8 milliohms/m.

$$\text{Design mV/A/m} = \left( \frac{230 + 67.4}{230 + 70} \right) \times 2.8 = 2.78 \text{ milliohms/m}$$

$$\text{Voltage drop} = \frac{2.78 \times 29 \times 70}{1000} \text{ V} = 5.64 \text{ V}$$

In this particular example the calculated conductor operating temperature is only marginally less than the maximum permitted normal operating temperature and there has been no real reduction gained in the calculated voltage drop. The problem is that from examination of the formula used to determine  $t_1$  it is very difficult to forecast what reduction will be obtained in the voltage drop.

To show the reduction in mV/A/m or  $(\text{mV/A/m})_r$  that is obtained for grouped circuits, Figures 2.3 and 2.4 have been prepared for 70°C thermoplastic insulated cables and 90°C thermosetting insulated cables respectively.

Each of these gives a family of curves of the reduction factor  $F$  plotted against  $I_b/I_{ta}$ , each curve in the family being for a particular value of  $C_a^2 C_g^2$ .

The use of these families of curves enables the designer to establish reasonably quickly the extent of the advantage found in any particular case, if the more accurate method of calculating voltage drop is used.

In some cases the reduction in the mV/A/m or  $(\text{mV/A/m})_r$  value that the more accurate method allows the designer to use, may show that it is not necessary to increase the conductor cross-sectional area.

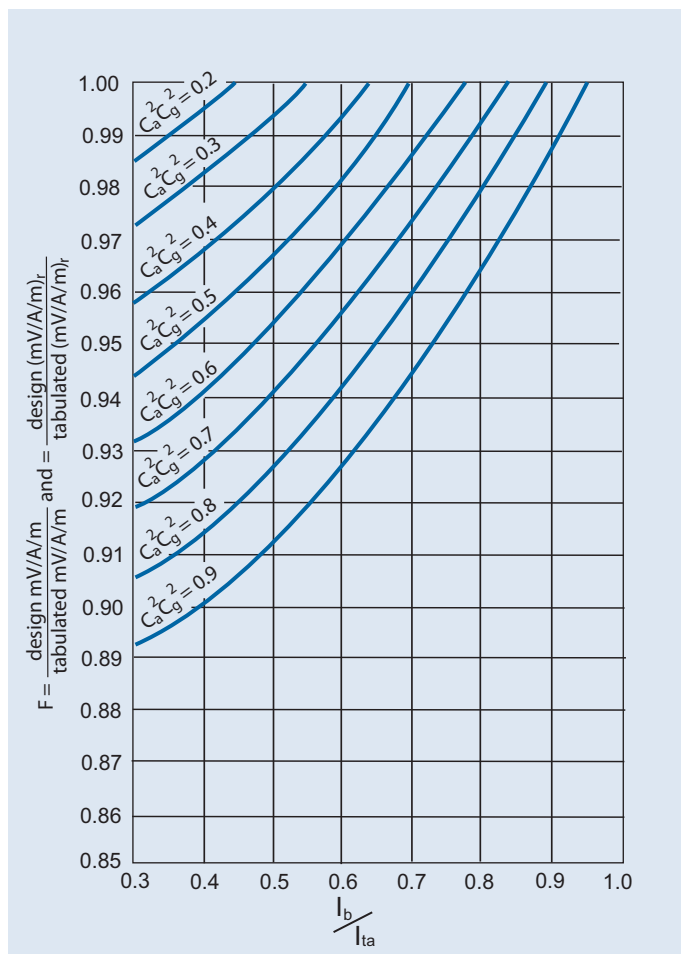
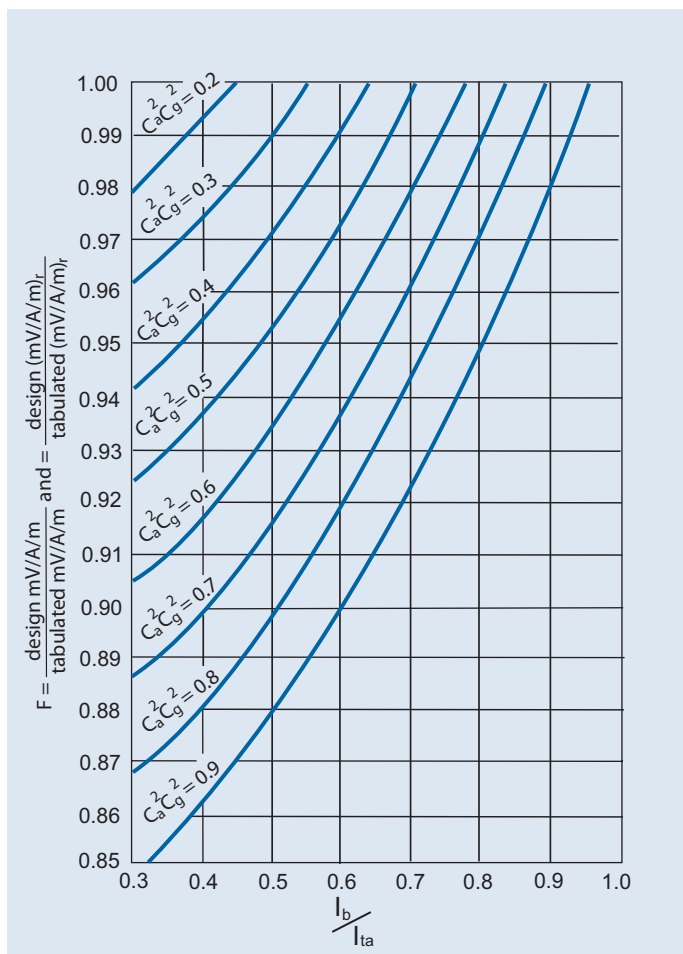

**Figure 2.3** Reduction factors for 70°C thermoplastic insulated cables, grouped, in ambient temperature of 30°C or greater.

In Chapter 1 it was noted that when the expected ambient temperature is less than 30°C and where the overcurrent protective device is providing overload protection, with or without short circuit protection, the limiting aspect when determining the ambient temperature correction factor is the need not to exceed the maximum tolerable conductor temperature under overload conditions. This, in turn, means that under normal load conditions the conductors will be operating at less than maximum normal operating temperature.

For circuits operating at ambient temperatures below 30°C and protected by other than BS 3036 semi-enclosed fuses against both overload and short circuit, the reduction factors in Table 2.1 may be applied to the tabulated mV/A/m or (mV/A/m)<sub>r</sub> values to obtain the design values.

The factors apply to both copper and aluminium conductors and thermoplastic insulation (both 70°C and 90°C types), as well as 90°C thermosetting insulation.



**Figure 2.4** Reduction factors for cables having 90°C thermosetting insulation, grouped, in ambient temperature of 30°C or greater.

**Table 2.1** Reduction factors for obtaining design values

Ambient temperature	Reduction factor
0°C	0.96
10°C	0.97
20°C	0.985

Little real advantage is found from using these reduction factors, particularly for the larger cable sizes, because they are applied only to the resistive component, i.e. to the  $(\text{mV/A/m})_r$  values. It will be seen from the volt drop tables in Appendix 4 of BS 7671 for the largest conductor sizes, particularly for single-core non-armoured cables, that the  $(\text{mV/A/m})_r$  value is very small compared with the  $(\text{mV/A/m})_x$  value. For such cables there is no point in taking account of conductor temperature.

## The more accurate approach taking account of load power factor

The power factor of the load is the other factor which influences voltage drop.

Where the power factor of the load is not known the designer has no option but to use the equations given at the beginning of this chapter for the simple approach, with or without adjustment for the conductor operating temperature.

Where the power factor,  $\cos \phi$ , of the load **is** known it is worthwhile using the following formulae.

For a.c. circuits using conductors of 16 mm<sup>2</sup> or less cross-sectional area:

$$\text{Voltage drop} = \frac{\text{tabulated mV/A/m} \times I_b \times l \times \cos \phi}{1000} \text{ V}$$

For a.c. circuits using conductors of 25 mm<sup>2</sup> or greater cross-sectional area, the voltage drop is given by:

$$\frac{[\text{tabulated } (\text{mV/A/m})_r \times \cos \phi + \text{tabulated } (\text{mV/A/m})_x \times \sin \phi] \times I_b \times l}{1000} \text{ V}$$

$$\text{where } \sin \phi = \sqrt{1 - \cos^2 \phi}.$$

### Example 2.16

A single-phase circuit having  $I_b = 27 \text{ A}$  is run in single-core 70°C thermoplastic insulated, non-sheathed, non-armoured cables having copper conductors and is enclosed in conduit on a wall with five other similar circuits. It is protected against both overload and short circuit by means of a 32 A mcb.

If  $t_a = 40^\circ\text{C}$ ,  $l = 38 \text{ m}$  and the power factor of the load is 0.8 lagging, what is the minimum conductor cross-sectional area that can be used and what is the voltage drop?

### Answer

From Table 4C1,  $C_g = 0.57$ . From Table 4B1,  $C_a = 0.87$ .

As  $C_i = 1$ :

$$I_t = 32 \times \frac{1}{0.57} \times \frac{1}{0.87} \text{ A} = 64.5 \text{ A}$$

From Table 4D1A Column 4 it is found that the minimum conductor cross-sectional area that can be used is 16 mm<sup>2</sup> having  $I_{ta} = 76$  A.

From Table 4D1B Column 3, the mV/A/m value is 2.8 milliohms/m.

$$\text{Voltage drop} = \frac{2.8 \times 27 \times 38 \times 0.8}{1000} \text{ V} = 2.3 \text{ V}$$

In this example no attempt has been made to take account of the conductor operating temperature being less than the maximum permitted value.

### Example 2.17

A single-phase circuit is wired in two-core armoured cable having 90°C thermosetting insulation and 25 mm<sup>2</sup> copper conductors.

If  $I_b = 120$  A and  $l = 30$  m, what is the voltage drop if the power factor of the load is 0.7 lagging?

### Answer

From Table 4E4B Column 3,  $(\text{mV/A/m})_r = 1.85$  milliohms/m and  $(\text{mV/A/m})_x = 0.16$  milliohms/m.

With  $\cos \phi = 0.7$ ,

$$\sin \phi = \sqrt{1 - 0.7^2} = 0.714$$

The voltage drop is given by:

$$\frac{(1.85 \times 0.7 + 0.16 \times 0.714) \times 120 \times 30}{1000} \text{ V} = 5.07 \text{ V}$$

Had the power factor been ignored, the voltage drop would have been calculated as:

$$\frac{1.9 \times 120 \times 30}{1000} \text{ V} = 6.84 \text{ V}$$

If then the circuit had a nominal voltage of 230 V and been limited to a 2.5% voltage drop (i.e. 5.8 V) the designer would have had apparently to use the larger conductor cross-sectional area of 35 mm<sup>2</sup>.

Figure 2.5 has been developed to show the advantage that may be gained by basing the voltage drop calculation on the more accurate  $[(\text{mV/A/m})_r \cos \phi + (\text{mV/A/m})_x \sin \phi]$  as compared with basing it on  $(\text{mV/A/m})_z$ .

For example a three-phase circuit is run in single-core armoured 70°C thermoplastic insulated cables having 400 mm<sup>2</sup> copper conductors, in trefoil, touching. The power factor of the load is 0.9 lagging. From Table 4D3B it is found that  $(\text{mV/A/m})_r = 0.12$  milliohms/m and  $(\text{mV/A/m})_z = 0.195$  milliohms/m.

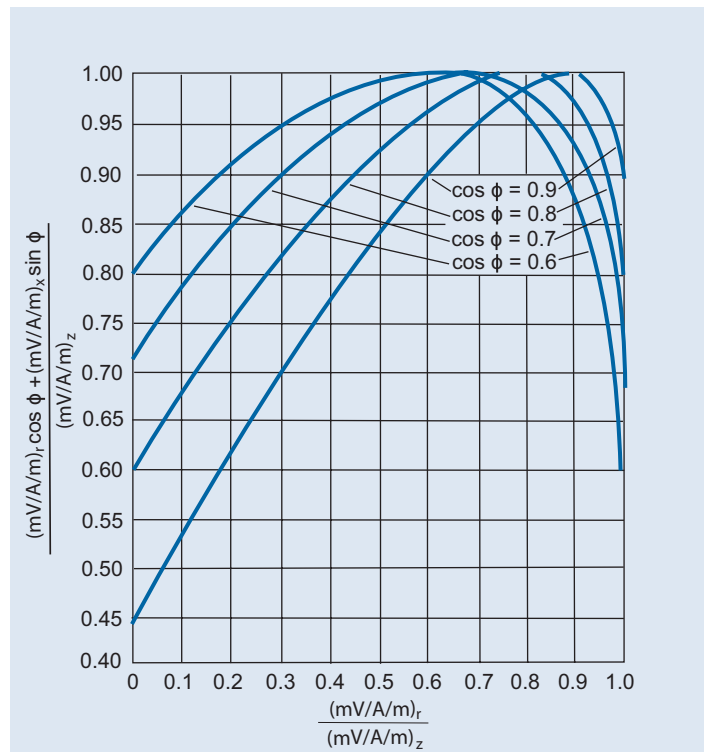

**Figure 2.5** Showing reduction in calculated voltage drop if load power factor is taken into account.

Thus:

$$\frac{(mV/A/m)_r}{(mV/A/m)_z} = \frac{0.12}{0.195} = 0.615$$

Figure 2.5 then indicates that calculating the voltage drop using  $[(mV/A/m)_r \cos \phi + (mV/A/m)_x \sin \phi]$  would give a value 0.9 times that calculated using  $(mV/A/m)_z$ .

As already stated, examination of the voltage drop sections of the tables in Appendix 4 of BS 7671 indicates that for conductors of the largest cross-sectional areas the  $(mV/A/m)_r$  values are much less than the  $(mV/A/m)_x$  values. For such cases one can ignore the  $(mV/A/m)_r$  values and calculate the voltage drop from:

$$\frac{(mV/A/m)_x \times \sin \phi \times I_b \times l}{1000} \text{ V}$$

or, of course, the designer may prefer to use the  $(mV/A/m)_z$  approach.

## The more accurate approach taking account of both conductor operating temperature and load power factor

The following examples show the calculations that are necessary where the designer wishes to take account of both the conductor operating temperature **and** the load power factor.

### Example 2.18

A single-phase circuit, run singly, uses two-core 90°C thermosetting insulated cable, clipped direct. The conductors are of copper and their cross-sectional area is 16 mm<sup>2</sup>.

If  $I_b = 65$  A,  $t_a = 50^\circ\text{C}$ , the load power factor is 0.7 lagging and  $l = 20$  m, what is the voltage drop?

### Answer

From Table 4E2A Column 6,  $I_{ta} = 107$  A.

$$t_p = 90^\circ\text{C} \text{ and } t_r = 30^\circ\text{C}$$

$$t_1 = 50 + \frac{65^2}{107^2} (90 - 30)^\circ\text{C} = 72.1^\circ\text{C}$$

Thus the reduction factor to be applied to the tabulated mV/A/m value to take account of  $t_1$  is

$$\frac{230 + 72.1}{230 + 90} = 0.94$$

From Table 4E2B Column 3 the tabulated mV/A/m value is 2.9 milliohms/m.

The voltage drop is therefore given by:

$$\frac{2.9 \times 0.94 \times 0.7 \times 65 \times 20}{1000} \text{ V} = 2.5 \text{ V}$$

Note that the reduction in the voltage drop caused by taking account of the load power factor is far greater than that caused by taking account of the conductor operating temperature.

### Example 2.19

A three-phase circuit is run, clipped direct and not grouped with other circuits, in a multicore armoured 70°C thermoplastic insulated cable having 95 mm<sup>2</sup> copper conductors.

If  $I_b = 160$  A,  $t_a = 45^\circ\text{C}$ , the load power is 0.8 lagging and  $l = 120$  m, what is the voltage drop?

### Answer

From Table 4D4A Column 3,  $I_{ta} = 231$  A, and from Column 4 of Table 4D4B  $(\text{mV/A/m})_r = 0.41$  milliohms/m and  $(\text{mV/A/m})_x = 0.135$  milliohms/m.

$$t_p = 70^\circ\text{C} \text{ and } t_r = 30^\circ\text{C}$$

Thus:

$$t_1 = 45 + \frac{160^2}{231^2} (70 - 30)^\circ\text{C} = 64.2^\circ\text{C}$$

The design  $(\text{mV}/\text{A}/\text{m})_r$  taking account of conductor operating temperature is given by:

$$\left( \frac{230 + 64.2}{230 + 70} \right) \times 0.41 \text{ milliohms}/\text{m} = 0.402 \text{ milliohms}/\text{m}$$

The design  $(\text{mV}/\text{A}/\text{m})_x$  remains the same as the tabulated value.

The voltage drop is given by:

$$[0.8 \times 0.402 + \sqrt{(1 - 0.8^2)} \times 0.135] \times \frac{160 \times 120}{1000} \text{ V} = 7.73 \text{ V}$$

## Voltage drop in ring circuits

Occasions may arise when it is necessary to calculate the voltage drop occurring in a ring circuit. The method to use is illustrated by Example 2.20 if the loads taken from the points of utilization and the cable lengths between those points are known.

### Example 2.20

Figure 2.6(a) shows a single-phase, 32 A, ring circuit wired in 2.5 mm<sup>2</sup> flat two-core (with cpc) 70°C thermoplastic insulated and sheathed cable. The figure gives the loads taken from each point of utilization. What is the voltage drop?

### Answer

The first stage is to determine the current distribution and as shown in Figure 2.6(b) a current given by  $I_x$  A is taken to flow in the first section,  $(I_x - 6)$  A in the second section, and so on.

If the resistance per metre of the phase conductor is denoted by 'r' then:

$$I_x 6r + (I_x - 6)4r + (I_x - 16)3r + (I_x - 22)6r + (I_x - 27)8r + (I_x - 32)4r = 0$$

From which:

$$I_x r(6 + 4 + 3 + 6 + 8 + 4) - r(24 + 48 + 132 + 216 + 128) = 0$$

Thus:  $I_x = 17.68 \text{ A}$

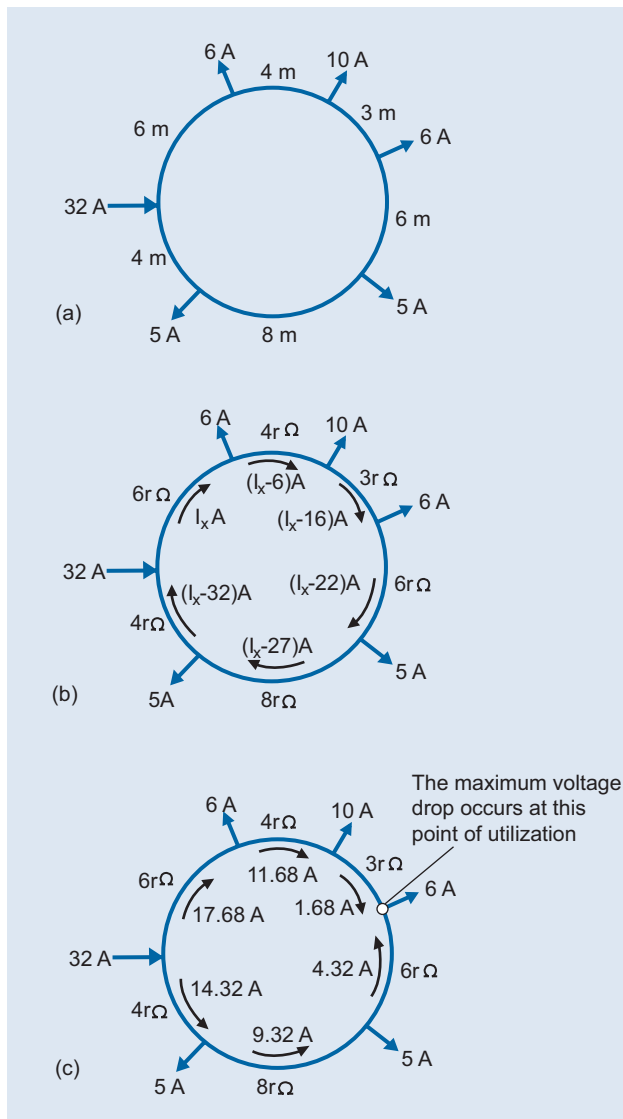

**Figure 2.6** Voltage drop in ring circuit.

The current distribution therefore is as shown in Figure 2.6(c) and it is now possible to calculate the voltage drop.

This is given by:

$$[(17.68 \times 6) + (1.68 \times 4) + (1.68 \times 3)] \times \frac{\text{mV/A/m}}{1000} \text{ V}$$

i.e.

$$\frac{157.84 \times \text{mV/A/m}}{1000} \text{ V}$$

From Table 4D2B Column 3 the mV/A/m value is found to be 18 milliohms/m.  
The voltage drop is therefore:

$$\frac{157.84 \times 18}{1000} \text{ V} = 2.84 \text{ V}$$

This can be checked by calculating the voltage drop in the anticlockwise direction to the point of utilization at which the maximum value occurs.

It can be shown that the maximum voltage drop that can occur in a ring circuit is when a load current equal to the nominal current of the overcurrent protective device of the circuit is taken from the midpoint of that circuit. On this basis the maximum length from the origin of the circuit to its midpoint for a 230 V single-phase 32 A ring circuit having a permitted 2.5% voltage drop (i.e. 5.8 V) is given by:

$$\frac{5800}{16 \times 18} \text{ m} = 20.1 \text{ m}$$

or, in other words, a maximum total length of 40.2 m.

Taking into account the fact that the circuit conductors are carrying only 16 A while their current-carrying capacity is 23 A if enclosed in conduit or 27 A if clipped direct (see Table 4D2A Column 4 and Table 4D5A Column 6) that maximum length of 40.2 m becomes 43.2 m or 44 m, respectively.

If one assumes, however, that the total load current, although still equal to the nominal current of the overcurrent protective device, is uniformly distributed around the ring, the maximum permitted length can be considerably greater.

For all the examples given in this chapter the design current of the circuit concerned has been stated and no indication has been given of the maximum permissible voltage drop.

The key regulation is Regulation 525.1, which does not directly specify what the latter shall be but requires the voltage at the terminals of any current-using equipment to be not less than the lower limit corresponding to the relevant British Standard. If that equipment is not the subject of a British Standard then the voltage at the terminals shall be such as not to impair the safe functioning of the equipment.

Regulation 525.3 states that Regulation 525.1 is deemed to be satisfied if the voltage drop between the origin of the installation and the current-using equipment does not exceed the values given in Appendix 12 of BS 7671. For installations supplied directly from the public distribution system the limits given in Appendix 12 are 3% for lighting systems and 5% for other circuits. Thus the designer could exceed 5% but still claim to satisfy Regulation 525.1. In determining what percentage could be allowed it must be borne in mind that the electricity supply industry has a statutory requirement to maintain the voltage at a consumer's terminals to within 94% to 110% of the nominal value.

It follows that having calculated the voltage drop inside the installation, the designer should add 6% of the nominal voltage to that voltage drop to determine the voltage at the points of utilization, and it is this value which may have to be compared with the limits given in the relevant British

Standard. It is felt there is no need to give an example illustrating this aspect but to devote the remainder of this chapter to the consideration of extra-low voltage circuits.

## Voltage drop in ELV circuits

Whichever type of extra-low voltage (ELV) circuit is used, whether it be safety ELV (SELV), or functional ELV (FELV), the calculation of voltage drop is of importance, particularly when the nominal voltage of the circuit is low, e.g. 12 V. Many of these circuits are fed from transformers and the first essential information required by the designer is the regulation of the transformer, where:

$$\text{Regulation} = \frac{U_{nl} - U_{fl}}{U_{nl}} \times 100\%$$

where:

$U_{nl}$  = output voltage at no-load, in volts

$U_{fl}$  = output voltage at full-load, in volts.

A 12 V luminaire may be fed from its own transformer in which case the output voltage at full load can be 12 V. If, however, a transformer is supplying a number of 12 V luminaires the full load output voltage will be less (say 11.8 V) to prevent overvoltage occurring should one of the lamps fail. Whichever method is used, the voltage at the luminaire should not be less than 11.4 V.

### Example 2.21

A 50 W 12 V luminaire is to be fed from a transformer having a full load output voltage of 12 V. If it is intended to use 70°C thermoplastic insulated and sheathed cable having 1.5 mm<sup>2</sup> copper conductors clipped direct, what is the maximum circuit length that can be tolerated if the voltage at the luminaire must not be less than 11.4 V? The ambient temperature  $t_a = 30^\circ\text{C}$ .

### Answer

From Table 4D2B Column 3, the mV/A/m = 29 milliohms/m.

$$I_b = \frac{50}{12} \text{ A} = 4.17 \text{ A}$$

Maximum permissible voltage drop = 0.6 V

Maximum permissible circuit length is given by:

$$\frac{0.6 \times 1000}{4.17 \times 29} \text{ m} = 4.96 \text{ m}$$

Note that  $I_{ta} = 19.5 \text{ A}$  (from Column 6 of Table 4D2A) and it is of interest to establish the maximum circuit length using the more accurate approach.

$$t_1 = 30 + \frac{4.17^2}{19.5^2} (70 - 30)^\circ\text{C} = 31.8^\circ\text{C}$$

The design mV/A/m is given by:

$$\left( \frac{230 + 31.8}{230 + 70} \right) \times 29 \text{ milliohms/m} = 25.3 \text{ milliohms/m}$$

The maximum circuit length is then given by:

$$\frac{0.6 \times 1000}{4.17 \times 25.3} \text{ m} = 5.69 \text{ m}$$

### Example 2.22

A 75 W 12 V luminaire together with others is to be fed from a transformer having a full load output voltage of 11.8 V. It is intended to use 90°C thermosetting insulated cables having 2.5 mm<sup>2</sup> copper conductors in conduit.

If  $t_a = 30^\circ\text{C}$ , what is the maximum circuit length that can be tolerated if the voltage at the luminaire must not be less than 11.4 V?

### Answer

From Table 4E2B Column 3, mV/A/m = 19 milliohms/m.

$$I_b = \frac{75}{12} \text{ A} = 6.25 \text{ A}$$

The maximum permissible voltage drop in the circuit is:

$$(11.8 - 11.4) \text{ V} = 0.4 \text{ V}$$

Maximum permissible circuit length is given by:

$$\frac{0.4 \times 1000}{19 \times 6.25} \text{ m} = 3.37 \text{ m}$$

Using the more accurate method, from Table 4E2A Column 4,  $I_{ta} = 30 \text{ A}$  and

$$t_1 = 30 + \frac{6.25^2}{30^2} (90 - 30)^\circ\text{C} = 32.6^\circ\text{C}$$

The design mV/A/m is given by:

$$\left( \frac{230 + 32.6}{230 + 90} \right) \times 19 \text{ milliohms/m} = 15.6 \text{ milliohms/m}$$

The maximum circuit length is then given by:

$$\frac{0.4 \times 1000}{15.6 \times 6.25} \text{ m} = 4.1 \text{ m}$$

It can be argued, however, that the more accurate method should not be used because it assumes only one luminaire is actually energized.

A decorative graphic at the top of the page features a blue background with various mathematical symbols and numbers. On the left, there's a large number '3'. In the center, there are several mathematical expressions like '11.4 x 28', '7.3 x 2', '4^2', '25', '8', and '2'. On the right, there's a detailed illustration of a blue calculator with a white keypad and a display screen showing '10 x 406'. The calculator has a percentage sign on the top right and a plus sign on the bottom right. The overall theme is technical and mathematical.

### 3

## Calculation of earth fault loop impedance

The most commonly used protective measure against indirect contact is that of automatic disconnection of supply using either the overcurrent protective devices (which also provide protection against overload and/or short circuit currents for the circuits concerned), residual current devices (RCDs) or combined devices (RCBOs).

Whichever type of device is chosen, it is necessary for the designer to calculate the earth loop impedance ( $Z_s$ ) of every circuit in the installation to check that these impedances do not exceed the maxima specified in BS 7671, Tables 41.4 to 41.5. The earth loop impedance that has to be considered is that which comprises the impedance of the source, the line conductor up to the fault plus the protective conductor from the fault to the source. Note that when an RCD or RCBO is used to provide automatic disconnection of the supply in a TN system, the calculation of  $Z_s$  is normally unnecessary, provided that continuity of the earth loop has been established.

Another reason for calculating the earth loop impedances is to check that the circuit protective conductors are adequately protected thermally, i.e. that they comply with the adiabatic equation given in Regulation 543.1.3. This aspect is the subject of Chapter 4.

One series of examples in this chapter shows the calculations that are necessary when the circuit conductors have a cross-sectional area of  $35\text{ mm}^2$  or less, where it has long been accepted that one can use conductor resistances instead of conductor impedances in those calculations. The other series of examples deals with the cases where conductor impedances should be used.

One question that remains unanswered in BS 7671:2008 is that of the conductor temperature at which the earth loop impedance should be calculated. Prior to Amendment 1 to BS 7671:1992 it was usual for the protective conductor impedance to be based on the average temperature attained during the fault, that is the average of the assumed initial temperature and the maximum permitted final temperature. Similarly for the phase conductor impedance it was usual to use the average of the maximum permitted normal operating temperature and the maximum permitted final temperature.

BS7671:1992 + Amd. 1:1994 included a regulation that required account to be taken of the increase in temperature and resistance of conductors as a result of the fault current. However, this Regulation also allowed a simpler approach to be taken under some conditions. For the devices listed in Appendix 3 of BS 7671:1994, see below, the requirement was deemed to be satisfied if the circuit loop impedance met the required when the conductors are at their normal operating temperature.

- (1) Fuses to BS 1361, up to 100 A
- (2) Semi-enclosed fuses to BS 3036, up to 100 A
- (3) Fuses to BS 88 Part 2 and Part 6, up to 200 A
- (4) Types B, C and D mcbs to BS EN 60898 and RCBOs to BS EN 61009, up to 125 A.

BS 7671:2008 contains no requirements in relation to the conductor temperature at which the earth loop impedance is calculated. However, the notes to the tables of maximum earth fault loop impedance, Tables 41.2 to 41.4, state that the tabulated values should not be exceeded when the conductors are at their normal operating temperature. These notes give the same information as the notes to the equivalent tables in BS 7671:1994. It is therefore reasonable to suggest that the conductor temperature that should be used in the calculation of fault loop impedance is determined on the same principle as that used to comply with BS 7671:1994.

Thus for the above devices the normal operating temperature for the phase conductor is generally taken to be the maximum permitted normal operating temperature.

Selection of the normal operating temperature of the protective conductor is less obvious. For a protective conductor incorporated in a cable or bunched with other cables, Table 54.3, the normal operating temperature is taken to be the maximum permitted normal operating temperature. For a protective conductor not incorporated in a cable and not bunched with other cables, Table 54.2B, it would appear reasonable to take the ambient temperature, 30°C, as the normal operating temperature. If the protective conductor has a much smaller cross-sectional area, then its temperature rise under fault conditions will be greater than that of the phase conductor. In such a case it would be prudent to base the impedance of the protective conductor on the maximum permitted normal operating temperature.

This method is not rigorously correct because it assumes that the conductor impedance does not increase significantly during a fault. The method is intended to take account of the effect of normal load currents on the operating characteristics of some protective devices. The operating characteristics given in Appendix 3 of BS 7671 are based on the device being at ambient temperature at the start of the fault. When a device such as a fuse carries the normal load current its temperature will increase and its operating time, in the event of a fault, will be less than that given by the characteristics given in Appendix 3 of BS 7671. The same principles apply to a circuit breaker operating on the thermal part of its characteristic.

The assumptions made above regarding conductor temperatures during fault conditions should only be used when calculating circuit impedance. The values of  $k$  given in Chapter 54 of BS 7671 should not be adjusted for lower final temperatures as this will reduce the value of  $k$  and consequently increase the conductor size required to comply with Regulation 543.1.3.

If the actual conductor operating temperature is known to be less than the maximum permitted normal operating temperature then the actual temperature can be used when calculating circuit impedance. The actual conductor temperature can also be used as the initial temperature to calculate a revised value of  $k$  (Chapter 4). This will be the case for circuits protected against overload by BS 3036 semi-enclosed fuses where the actual operating temperature will be less than the maximum potential operating temperature (Chapter 2 and Example 3.8).

For devices other than those listed above it is necessary to calculate the earth fault loop impedance for the conductors based on the average of the initial temperature and the maximum permitted final temperature. Again, if the actual conductor operating temperature, or ambient temperature, is known these can be used to calculate the average temperature during the fault.

Consider first of all final circuits connected directly to the source at an installation's main distribution board (in the smaller installation, a consumer unit) and where the source is the public low voltage supply network.

The Energy Networks Association has stated, in Engineering Recommendation P23, that typical maximum values for  $Z_E$ , defined as that part of the earth fault loop impedance external to the

installation, are 0.35 ohm for TN–C–S systems and 0.80 ohm for TN–S systems. These values are used for many of the examples for the purpose of illustration but in practice it is, of course, acceptable to use **measured** values of  $Z_E$ .

For the moment consideration is limited to cables having conductors of 35 mm<sup>2</sup> or less cross-sectional area and for the purposes of calculating  $Z_s$ , their reactances can be ignored.

Thus for radial circuits:

$$Z_s = Z_E + R_1 + R_2 \text{ ohm}$$

and for ring circuits:

$$Z_s = Z_E + 0.25 (R_{T1} + R_{T2}) \text{ ohm}$$

where:

$R_{T1}$  = resistance of the phase conductor prior to connecting the ends to form a ring;

$R_{T2}$  = resistance of the protective conductor prior to connecting the ends to form a ring.

It is important to note that when Table 54.2 applies, the values shown in Columns 3 and 5 of Table 3.1 can only be used for the combinations of phase conductor and protective conductors given in Columns 1 and 2 (when these conductors are of copper). Where the intended combination is not given, use the data given in Tables 3.3, 3.4 and 3.5.

For example, if the phase conductor has a cross-sectional area of 6 mm<sup>2</sup> and the protective conductor is 1.5 mm<sup>2</sup>,  $(R_1 + R_2)/m$  for 90°C thermosetting insulation is **not** (3.94 + 15.5) milliohms/m, i.e. 19.44 milliohms/m. For the correct figure see Example 6.3.

However, when Table 54.3 applies, the values shown in Columns 4 and 6 of Table 3.1 apply to any combinations of phase conductor and protective conductor, when they are of copper. A similar restriction applies to Table 3.2 when the conductors are of aluminium.

To assist the reader, Tables 3.1 and 3.2 have been developed for copper conductors and aluminium conductors respectively giving values for  $R_1/m$  and  $(R_1 + R_2)/m$  in milliohms per metre for 70°C thermoplastic insulated cable and 90°C thermosetting insulated cable. The tabulated values have been based on the simplified formula given in BS 6360 which uses the resistance–temperature coefficient of 0.004 per °C at 20°C.

The values given in Tables 3.1 and 3.2 are based on assumed normal operating temperatures. When the protective conductor complies with the conditions of Table 54.2 its normal operating temperature is taken to be 30°C and that of the associated phase conductor is taken to be its maximum permitted normal operating temperature. When the protective conductor complies with the conditions of Table 54.3 the normal operating temperature of both the phase and protective conductors is taken to be the maximum permitted operating temperature.

When the protective device is not of a type listed above, values of  $R_1$  and  $R_2$  can be calculated from the values given in Table 3.3 by using the factors given in brackets in the lower half of Table 3.4.

Table 52.3 of BS 7671 does not permit aluminium conductors of less than 16 mm<sup>2</sup> cross-sectional area.

**Table 3.1** Values of  $R_1/m$  and  $(R_1 + R_2)/m$  in milliohms/metre for copper conductors at their normal operating temperature

Conductor cross-sectional area, mm <sup>2</sup>		70°C thermoplastic insulation		90°C thermoplastic or thermosetting insulation	
Phase conductor	Protective conductor	When Table 54.2 applies	When Table 54.3 applies	When Table 54.2 applies	When Table 54.3 applies
1	2	3	4	5	6
1	—	21.7	21.7	23.2	23.2
1	1	40.5	43.4	42.0	46.3
1.5	—	14.5	14.5	15.5	15.5
1.5	1	33.3	36.2	34.3	38.7
1.5	1.5	27.1	29.0	28.1	31.0
2.5	—	8.89	8.89	9.48	9.48
2.5	1	27.7	30.6	28.3	32.7
2.5	1.5	21.5	23.4	22.1	25.0
2.5	2.5	16.6	17.8	17.2	19.0
4	—	5.53	5.53	5.90	5.90
4	1.5	18.1	20.1	18.5	21.4
4	2.5	13.2	14.4	13.6	15.4
4	4	10.3	11.1	10.7	11.8
6	—	3.70	3.70	3.94	3.94
6	2.5	11.4	12.6	11.6	13.4
6	4	8.49	9.23	8.74	9.84
6	6	6.90	7.39	7.15	7.88
10	—	2.20	2.20	2.34	2.34
10	4	6.99	7.73	7.14	8.24
10	6	5.40	5.89	5.55	6.28
10	10	4.10	4.39	4.25	4.68
16	—	1.38	1.38	1.47	1.47
16	6	4.58	5.08	4.68	5.41
16	10	3.28	3.58	3.38	3.81
16	16	2.58	2.76	2.67	2.94
25	—	0.872	0.872	0.931	0.931

**Table 3.1** (Continued)

Conductor cross-sectional area, mm <sup>2</sup>		70°C thermoplastic insulation		90°C thermoplastic or thermosetting insulation	
Phase conductor	Protective conductor	When Table 54.2 applies	When Table 54.3 applies	When Table 54.2 applies	When Table 54.3 applies
1	2	3	4	5	6
25	10	2.78	3.07	2.83	3.27
25	16	2.07	2.25	2.13	2.40
25	25	1.63	1.74	1.69	1.86
35	—	0.629	0.629	0.671	0.671
35	16	1.82	2.01	1.87	2.14
35	25	1.38	1.50	1.43	1.60
35	35	1.17	1.26	1.22	1.34

**Table 3.2** Values of  $R_1/m$  and  $(R_1 + R_2)/m$  in milliohms/metre for aluminium conductors at their normal operating temperature

Conductor cross-sectional area mm <sup>2</sup>		70°C thermoplastic insulation		90°C thermoplastic or thermosetting insulation	
Phase conductor	Protective conductor	When Table 54.2 applies	When Table 54.3 applies	When Table 54.2 applies	When Table 54.3 applies
1	2	3	4	5	6
16	—	2.29	2.29	2.44	2.44
16	6	—	—	—	—
16	10	—	—	—	—
16	16	4.28	4.58	4.43	4.89
25	—	1.44	1.44	1.54	1.54
25	10	—	—	—	—
25	16	3.43	3.73	3.52	3.98
25	25	2.69	2.88	2.78	3.07
35	—	1.04	1.04	1.11	1.11
35	16	3.03	3.33	3.10	3.56
35	25	2.29	2.48	2.36	2.65
35	35	1.94	2.08	2.01	2.22

## The simple approach

### Example 3.1

A single-phase circuit is run in single-core 70°C thermoplastic insulated and sheathed cables clipped direct and not bunched with cables of other circuits. Protection against indirect contact is provided by a device of a type listed earlier in this chapter.

If the conductors are copper, the cross-sectional area of the live conductors is 4 mm<sup>2</sup> and that of the protective conductor is 2.5 mm<sup>2</sup>,  $l$  is 45 m and  $Z_E$  is assumed to be 0.35 ohm (the supply being PME), what is the earth fault loop impedance?

### Answer

The relevant table is Table 54.2 so that the value of  $(R_1 + R_2)/m$  in milliohms/metre is obtained from Column 3 in Table 3.1. It is found to be 13.2 milliohms/m.

$$Z_s = 0.35 + \left( \frac{45 \times 13.2}{1000} \right) \text{ohm} = 0.94 \text{ ohm}$$

Note that as the protective conductor cross-sectional area does not comply with Table 54.7, it would be necessary to check that it was thermally protected by using the adiabatic equation of Regulation 543.1.3. To do this it is necessary to know the type and current rating of the protective device associated with the circuit and be in possession of its time/current characteristic (examples in Chapter 4).

### Example 3.2

A circuit is run in single-core 70°C thermoplastic insulated cables having copper conductors, these being bunched with cables of other circuits in conduit. Protection against indirect contact is provided by a device of a type listed earlier in this chapter.

If  $l = 20$  m, the cross-sectional area of the live conductors is 25 mm<sup>2</sup> and that of the protective conductor is 10 mm<sup>2</sup> and  $Z_E = 0.8$  ohm, what is the earth fault loop impedance?

### Answer

Because the circuit concerned is bunched with other circuits, the relevant table is Table 54.3.  $(R_1 + R_2)/m$  in milliohms per metre is obtained from Column 4 of Table 3.1 and is found to be 3.07 milliohms/m.

$$Z_s = 0.8 + \left( \frac{20 \times 3.07}{1000} \right) \text{ohm} = 0.861 \text{ ohm}$$

As in Example 3.1, the protective conductor does not comply with Table 54.7 and it would be necessary to check compliance with the adiabatic equation of Regulation 543.1.3.

**Example 3.3**

A single-phase ring circuit is run in 2.5 mm<sup>2</sup> 70°C thermoplastic insulated and sheathed flat cable (the protective conductor having therefore a cross-sectional area of 1.5 mm<sup>2</sup>). Protection against indirect contact is provided by a device of a type listed earlier in this chapter.

If  $l = 65$  m and  $Z_E = 0.35$  ohm, what is the earth fault loop impedance?

**Answer**

Because the protective conductor is an integral part of the cable, the relevant table is Table 54.3 and Column 4 of Table 3.1 applies.

From that column and table,  $(R_1 + R_2)/m = 23.4$  milliohms/m

$$Z_s = 0.35 + \left( \frac{0.25 \times 65 \times 23.4}{1000} \right) \text{ ohm} = 0.73 \text{ ohm}$$

Note the introduction of the factor 0.25 because the circuit concerned is a ring circuit. Also note the need to check against the adiabatic equation of Regulation 543.1.3.

To determine the earth fault loop impedance of a spur on a ring circuit, strictly it is necessary to estimate the fractional distance of that spur from the origin of the circuit. Denote that distance by 'y'.

Then the earth fault loop impedance at the remote end of the spur is given by:

$$Z_s = Z_E + y(1 - y)(R_{1T} + R_{2T}) + R_{1S} + R_{2S} \text{ ohm}$$

where:

$R_{1T}$  = total resistance of the phase conductor of the ring circuit, ohm

$R_{2T}$  = total resistance of the protective conductor of the ring circuit, ohm

$R_{1S}$  = resistance of the phase conductor of the spur, ohm

$R_{2S}$  = resistance of the protective conductor of the spur, ohm.

**Example 3.4**

A single-phase ring circuit is run in 2.5 mm<sup>2</sup> 70°C thermoplastic insulated and sheathed flat cable (the protective conductor cross-sectional area being 1.5 mm<sup>2</sup>). The total length of the ring circuit is 80 m. A spur taken from the ring is run in the same cable, the length of the spur being 12 m. Protection against indirect contact is provided by a device of a type listed earlier in this chapter.

If it is estimated that the spur is taken from the ring 30 m from the origin and  $Z_E = 0.35$  ohm, what is the earth fault loop impedance for the spur?

**Answer**

$$y = \frac{30}{80} = 0.375$$

The relevant table for both the ring and spur is Table 54.3 and Column 4 of Table 3.1 applies. From that column and table,  $(R_1 + R_2)/m = 23.4$  milliohms/m.

For the ring circuit:

$$(R_{1T} + R_{2T}) = \frac{23.4 \times 80}{1000} \text{ ohm} = 1.87 \text{ ohm}$$

For the spur:

$$(R_{1S} + R_{2S}) = \frac{23.4 \times 12}{1000} \text{ ohm} = 0.281 \text{ ohm}$$

Thus:

$$Z_s = 0.35 + (0.375 \times 0.625 \times 1.87) + 0.281 \text{ ohm} = 1.07 \text{ ohm}$$

The factor 0.625 in the above equation is, of course  $(1 - 0.375)$ , namely  $(1 - y)$ .

The alternative method, giving a pessimistically high result, is to calculate the earth fault loop impedance of the spur as if it was taken from the midpoint of the ring circuit. For the above example this would lead to:

$$Z_s = 0.35 + (0.25 \times 1.87) + 0.281 \text{ ohm} = 1.10 \text{ ohm}$$

### Example 3.5

A three-phase circuit, bunched with other circuits, is run in single-core 90°C thermosetting insulated cable having copper conductors, and the live and protective conductors being 16 mm<sup>2</sup> cross-sectional area. A device of a type not included in the earlier list provides protection against indirect contact.

If  $l = 30$  m and  $Z_E = 0.8$  ohm, what is the earth fault loop impedance?

### Answer

Because the circuit is bunched with other circuits, Table 54.3 is relevant and the values of  $R_1$  and  $R_2$  are obtained from Table 3.3 with the factors from Table 3.4.

Thus:

$$Z_s = 0.8 + \frac{(1.60 \times 1.15 + 1.60 \times 1.15)}{1000} \times 30 = 0.91 \text{ ohm}$$

Unlike those of the previous examples the protective conductor does comply with Table 54.7 and therefore it is not necessary to check compliance with the adiabatic equation of Regulation 543.1.3 provided the overcurrent protective device is intended to give **overload** protection. See also Example 4.1.

**Example 3.6**

A 230 V single-phase circuit is run in flat two-core (with cpc) 70°C thermoplastic insulated and sheathed cable, the cross-sectional area of the live conductors being 10 mm<sup>2</sup> and that of the protective conductor being 4 mm<sup>2</sup>. The circuit is protected by a 50 A BS 88–2.2 ‘gG’ fuse. Because this circuit is not covered by Regulation 411.3.2.2, Regulation 411.3.2.3 applies and a disconnection time of not more than 5 seconds is permitted.

If  $l = 30$  m, check whether the circuit complies with Table 41.4 of BS 7671 when  $Z_E = 0.6$  ohm.

**Answer**

From Table 41.4 the maximum permitted earth fault loop impedance is found to be 1.04 ohm.

Check the earth fault loop impedance ( $Z_s$ ).

As Table 54.3 applies, from Table 3.1 Column 4, the value of  $(R_1 + R_2)/m$  is 7.73 milliohms/m. Thus:

$$R_1 + R_2 = \frac{7.73 \times 30}{1000} \text{ ohm} = 0.232 \text{ ohm}$$

$$Z_s = (0.6 + 0.232) \text{ ohm} = 0.832 \text{ ohm}$$

The circuit therefore complies with Table 41.4.

**Example 3.7**

A 230 V single-phase final circuit is run in flat two-core (with cpc) 70°C thermoplastic insulated and sheathed cable, the cross-sectional area of the live conductors being 2.5 mm<sup>2</sup> and that of the protective conductor being 1.5 mm<sup>2</sup>. The circuit is protected by a 20 A BS 88–2.2 ‘gG’ fuse. The required disconnection time for this circuit is 0.4 seconds, Regulation 411.3.2.2, thus Table 41.2 applies.

If  $l = 50$  m, check whether the circuit complies with Table 41.2 of BS 7671 when  $Z_E = 0.8$  ohm.

**Answer**

From Table 41.2 the maximum permitted earth fault loop impedance is found to be 1.77 ohm.

Check the earth fault loop impedance ( $Z_s$ ).

As Table 54.3 applies, from Table 3.1 Column 4, the value of  $(R_1 + R_2)/m$  is 23.4 milliohms/m. Thus:

$$R_1 + R_2 = \frac{23.4 \times 50}{1000} \text{ ohm} = 1.17 \text{ ohm}$$

$$Z_s = (0.8 + 1.17) \text{ ohm} = 1.97 \text{ ohm}$$

The circuit therefore does not comply with Table 41.2. When the disconnection times required by Regulation 411.3.2.1 are not achieved, Regulation 411.3.2.6 requires that supplementary equipotential bonding is provided. Regulation 415.2 sets out the requirements for supplementary equipotential bonding. The effectiveness of the supplementary bonding can be checked using the equation given in Regulation 415.2.2:

$$R \leq \frac{50}{I_a}$$

where:

R = the resistance between simultaneously accessible exposed-conductive-parts and extraneous conductive parts;

$I_a$  = the operating current of the protective device, for fuses the current causing operation in 5 seconds.

In this example the protective device is a 20 A BS 88–2.2 fuse.

From Fig. 3.3A of Appendix 3,  $I_a = 79 \text{ A}$

$$R \leq \frac{50}{79} = 0.633 \text{ ohms}$$

If a sheathed 1.5 mm<sup>2</sup> supplementary bonding conductor is used and taking the ambient temperature to be 20°C, the resistance of the conductor is 12.1 milliohms/m. Thus the maximum permitted length, L, of any supplementary bonding conductor is:

$$L = \frac{0.633 \times 1000}{12.1} = 52.3 \text{ m}$$

As the supplementary bonding conductor is needed to join simultaneously accessible parts, it is unlikely to be more than a few metres long so this calculation will seldom be required.

The examples so far have followed the principle stated earlier. Where Table 54.2 applies, i.e. where the temperature of the circuit protective conductor is lower than that of the associated phase conductor, their resistances under fault conditions are calculated separately because their temperatures under those conditions are assumed to be different.

It will be seen from Table 3.1, for thermoplastic insulation and a particular combination of cross-sectional areas of the phase and circuit protective conductors that the difference between the Table 54.2 and Table 54.3 values is generally not more than 10%, the latter being the larger, similarly for Table 3.2.

Thus the designer has a further option of adopting the appropriate Table 54.3 value irrespective of the method of installation of the cable(s) concerned and without incurring an over-pessimistic calculated value of earth fault loop impedance. This also has the advantage of taking account of the greater temperature rise of a protective conductor which has a smaller cross-sectional area than the phase conductor.

## The more accurate approach taking account of conductor temperature

Bearing in mind that the formulae for determining the earth fault loop impedance are inherently approximate and that often the designer has to assume the value of  $Z_{E1}$ , there is no real justification for then attempting to make a more accurate calculation of earth fault loop impedance.

If a more accurate calculation is felt to be necessary, however, one possible method is based on using the actual ambient temperature ( $t_a$  °C) and not 30°C ( $t_r$  °C) when Table 54.2 applies, and using the calculated conductor operating temperature ( $t_1$  °C) instead of the maximum normal operating temperature ( $t_p$  °C) in calculating the earth fault loop impedance.

When Table 54.3 applies,  $t_1$  °C would be used in the calculation for both the live and protective conductors.

Tables 3.3 and 3.4 have been prepared, the former giving values of resistance per metre at 20°C for conductors up to and including 35 mm<sup>2</sup> while the latter gives the multipliers to be applied to those

**Table 3.3** Conductor resistances at 20°C in milliohms/metre

Cross-sectional area mm <sup>2</sup>	Copper	Aluminium
1	18.1	—
1.5	12.1	—
2.5	7.41	—
4	4.61	—
6	3.08	—
10	1.83	—
16	1.15	1.91
25	0.727	1.2
35	0.524	0.868

**Table 3.4** Multipliers to be applied to resistance values of Table 3.3 to give  $R_1/m$  and  $(R_1 + R_2)/m$  in milliohms/metre for impedance calculations

		70°C thermoplastic insulation <sup>a</sup>	90°C thermosetting insulation <sup>a</sup>
Protective device listed in Appendix 3 of BS 7671			
Where Table 54.2 applies	Protective conductor	$0.92 + 0.004t_a$	$0.92 + 0.004t_a$
	Phase conductor	$0.92 + 0.004t_1$	$0.92 + 0.004t_1$
Where Table 54.3 applies	Both conductors	$0.92 + 0.004t_1$	$0.92 + 0.004t_1$
Protective device <i>not</i> listed in Appendix 3 of BS 7671			
Where Table 54.2 applies	Protective conductor	$1.24 + 0.002t_a$ (1.30)	$1.42 + 0.002t_a$ (1.48)
	Phase conductor	$1.24 + 0.002t_1$ (1.38)	$1.42 + 0.002t_1$ (1.60)
Where Table 54.3 applies	Both conductors	$1.24 + 0.002t_1$ (1.38)	$1.42 + 0.002t_1$ (1.60)

<sup>a</sup> Values in brackets are based on an ambient temperature of 30°C and an initial temperature which is equal to the maximum permitted normal operating temperature.

**Table 3.5** Multipliers corresponding to  $t_a = 30^\circ\text{C}$  and various values of  $t_1$  to be applied to the resistance values of Table 3.3

Temperature $t_1$	70°C thermoplastic insulation	90°C thermosetting insulation
40	1.08	1.08
50	1.12	1.12
60	1.16	1.16
70	–	1.20
80	–	1.24

values, to determine the  $(R_1 + R_2)/m$  values for use in the earth fault loop impedance calculations. Table 3.5 gives factors, calculated from the first part of Table 3.4, for various values of  $t_1$ .

### Example 3.8

A circuit is run in single-core 90°C thermosetting insulated cables having copper conductors clipped direct, not grouped with the cables of other circuits. Protection against indirect contact is provided by a device of a type listed earlier in this chapter, other than a semi-enclosed fuse. The phase conductor has a cross-sectional area of  $10\text{mm}^2$  while the protective conductor has a cross-sectional area of  $4\text{mm}^2$ .

If  $t_a = 45^\circ\text{C}$ ,  $t_1 = 70^\circ\text{C}$ ,  $l = 40\text{m}$  and  $Z_E = 0.35\text{ohm}$ , what is the earth fault loop impedance?

### Answer

For the protective conductor, because Table 54.2 applies:

$$R_2 = \frac{4.61 \times [0.92 + (0.004 \times 45)] \times 40}{1000} \text{ohm} = 0.203 \text{ohm}$$

For the phase conductor:

$$R_1 = \frac{1.83 \times [0.92 + (0.004 \times 70)] \times 40}{1000} \text{ohm} = 0.088 \text{ohm}$$

Thus:

$$Z_s = (0.35 + 0.088 + 0.203) \text{ohm} = 0.641 \text{ohm}$$

Had the simpler approach been used, from Column 5 of Table 3.1  $(R_1 + R_2)/m = 7.14$  milliohms/m.

$$Z_s = 0.35 + \left( \frac{7.14 \times 40}{1000} \right) \text{ohm} = 0.634 \text{ohm}$$

Note that in this particular case the simpler approach gives a marginally lower calculated  $Z_s$ , because the higher temperature of the protective conductor has more effect than the low temperature of the phase conductor.

### Example 3.9

A single-phase circuit is protected against overload by a BS 3036 semi-enclosed fuse. The circuit is run in flat twin-core 70°C thermoplastic insulated and sheathed cable (with cpc) having copper conductors. The cross-sectional area of the phase conductor is 6 mm<sup>2</sup> and that of the protective conductor is 2.5 mm<sup>2</sup>.

If  $t_a = t_r = 30^\circ\text{C}$ ,  $l = 50\text{ m}$  and  $Z_E = 0.35\text{ ohm}$ , what is the earth fault loop impedance of the circuit?

### Answer

As indicated in Chapter 2, because the BS 3036 fuse is providing overload protection,  $t_1$  cannot exceed 51°C when  $t_a = 30^\circ\text{C}$ .

Table 54.3 applies and from Table 3.4 the multiplying factor is:

$$0.92 + (0.004 \times 51) = 1.124.$$

From Table 3.3,  $(R_1 + R_2)/\text{m}$  at 20°C = (3.08 + 7.41) milliohms/m.

Thus:

$$Z_s = 0.35 + \frac{1.124 \times (3.08 + 7.41) \times 50}{1000} \text{ ohm} = 0.940 \text{ ohm}$$

Had the simpler method been used,  $Z_s$  would have been 0.98 ohm. This demonstrates that the more accurate method for calculating  $Z_s$  gives only a slight difference in  $(R_1 + R_2)$  and hence in  $Z_s$ .

### Example 3.10

A three-phase circuit is run in single-core copper 70°C thermoplastic insulated and sheathed cables clipped direct and not grouped with cables of other circuits. The cross-sectional area of the phase conductors is 25 mm<sup>2</sup> and that of the protective conductor is 10 mm<sup>2</sup>. A device of a type not included in the earlier list provides protection against indirect contact.

If  $t_a = 5^\circ\text{C}$ ,  $t_1 = 70^\circ\text{C} = t_p$  (i.e. the maximum permitted normal operating temperature),  $Z_E = 0.8\text{ ohm}$  and  $l = 20\text{ m}$ , what is the earth fault loop impedance?

### Answer

Table 54.2 applies so that from Table 3.4 the multiplier for the protective conductor is:

$$1.24 + (0.002 \times 5) = 1.25$$

and the multiplier for the phase conductor is:

$$1.24 + (0.002 \times 70) = 1.38$$

Using the appropriate resistance per metre values from Table 3.3:

$$R_1 = \frac{1.38 \times 0.727 \times 20}{1000} \text{ ohm} = 0.0201 \text{ ohm}$$

$$R_2 = \frac{1.25 \times 1.83 \times 20}{1000} \text{ ohm} = 0.0458 \text{ ohm}$$

Thus:

$$Z_s = (0.8 + 0.0201 + 0.0458) \text{ ohm} = 0.866 \text{ ohm}$$

The only advantage gained by using this method in this particular case is a very marginal reduction in the calculated value of  $R_2$ . Had the simple method been used which assumes  $t_a = t_r = 30^\circ\text{C}$   $R_2$  would have been:

$$\frac{1.30 \times 1.83 \times 20}{1000} \text{ ohm} = 0.0476 \text{ ohm}$$

To complete this particular section it is of interest to show further how the tabulated mV/A/m values (or the (mV/A/m)<sub>r</sub> values for larger cables) given in Appendix 4 of BS 7671 can be used to determine conductor resistances at any temperature. Some readers might prefer this approach to that of using the tables given earlier in this chapter.

For single-phase circuits the resistance of **one conductor** in ohms at any temperature  $t_x^\circ\text{C}$  is given by:

$$\frac{\text{Tabulated mV/A/m}}{2 \times 1000} \times \left( \frac{230 + t_x}{230 + t_p} \right) \times \text{length of circuit in metres}$$

For three-phase circuits the resistance of **one conductor** in ohms at any temperature  $t_x^\circ\text{C}$  is given by:

$$\frac{\text{Tabulated mV/A/m}}{\sqrt{3} \times 1000} \times \left( \frac{230 + t_x}{230 + t_p} \right) \times \text{length of circuit in metres}$$

### Example 3.11

A single-phase circuit is run in 16 mm<sup>2</sup> two-core (with cpc) flat 70°C thermoplastic insulated and sheathed cable, the cross-sectional area of the protective conductor being 6 mm<sup>2</sup>. Protection against indirect contact is provided by a device of a type listed earlier in this chapter, other than a semi-enclosed fuse.

If  $l = 40\text{m}$  and  $t_x = 55^\circ\text{C}$ , calculate  $(R_1 + R_2)$  at that temperature.

**Answer**

Table 4D2B is the relevant table and  $t_p = 70^\circ\text{C}$ .

From Column 3 of Table 4D2B, tabulated  $\text{mV/A/m}$  for  $16\text{ mm}^2$  is 2.8 milliohms/m and tabulated  $\text{mV/A/m}$  for  $6\text{ mm}^2$  is 7.3 milliohms/m.

$$R_1 = \frac{2.8}{2 \times 1000} \times \left( \frac{230 + 55}{230 + 70} \right) \times 40 \text{ ohm} = 0.0532 \text{ ohm}$$

$$R_2 = \frac{7.3}{2 \times 1000} \times \left( \frac{230 + 55}{230 + 70} \right) \times 40 \text{ ohm} = 0.1387 \text{ ohm}$$

Therefore  $(R_1 + R_2) = 0.192 \text{ ohm}$

**Example 3.12**

A single-phase circuit is run in single-core non-armoured  $90^\circ\text{C}$  thermosetting insulated cables not bunched with cables of other circuits. The cross-sectional area of the live conductors is  $16\text{ mm}^2$  and that of the circuit protective conductor is  $10\text{ mm}^2$ . The conductors are of copper. The ambient temperature is  $50^\circ\text{C}$  and it has been calculated that the live conductors under normal load operate at  $72^\circ\text{C}$ . A device of a type not included in the earlier list provides protection against indirect contact.

If  $l = 45\text{ m}$ , calculate  $(R_1 + R_2)$  under earth fault conditions for the purpose of determining the earth fault loop impedance of the circuit.

**Answer**

Table 4E1B is the relevant table from which the  $\text{mV/A/m}$  for  $16\text{ mm}^2$  is 2.9 milliohms/m and for  $10\text{ mm}^2$  is 4.7 milliohms/m.

From Table 54.2 it is seen that for  $90^\circ\text{C}$  thermosetting insulation the maximum permitted final temperature is  $250^\circ\text{C}$ .

Thus for the phase conductor the average temperature under earth fault conditions is:

$$\frac{72 + 250}{2}^\circ\text{C} = 161^\circ\text{C}$$

$R_1$  is therefore:

$$\frac{2.9}{2 \times 1000} \times \left( \frac{230 + 161}{230 + 90} \right) \times 45 \text{ ohm} = 0.080 \text{ ohm}$$

For the protective conductor the average temperature under earth fault conditions is:

$$\frac{50 + 250}{2}^\circ\text{C} = 150^\circ\text{C}$$

$R_2$  is therefore:

$$\frac{4.7}{2 \times 1000} \times \left( \frac{230 + 150}{230 + 90} \right) \times 45 \text{ ohm} = 0.126 \text{ ohm}$$

Therefore  $(R_1 + R_2) = 0.206 \text{ ohm}$

### Example 3.13

A three-phase circuit is run in 16 mm<sup>2</sup> multicore non-armoured 70°C thermoplastic insulated cable having aluminium conductors. Protection against indirect contact is provided by a device of a type listed earlier in this chapter.

If  $l = 50 \text{ m}$ ,  $t_a = 15^\circ\text{C}$  and the calculated conductor temperature under normal load ( $t_1^\circ\text{C}$ ) is  $45^\circ\text{C}$ , calculate  $(R_1 + R_2)$  under earth fault conditions for the purpose of determining the earth fault loop impedance of the circuit.

### Answer

Table 4H2B is the relevant table and from Column 4 of the volt drop section mV/A/m is found to be 3.9 milliohms/m.

The assumed temperature under earth fault conditions for a phase conductor and the circuit protective conductor is  $45^\circ\text{C}$ .

Because Table 54.3 applies, the ambient temperature is not required for the calculations.  $(R_1 + R_2)$  is therefore:

$$\frac{2 \times 3.9}{\sqrt{3} \times 1000} \times \left( \frac{230 + 45}{230 + 70} \right) \times 50 \text{ ohm} = 0.206 \text{ ohm}$$

In the previous examples a value of  $Z_E$  has been given without its resistance and reactance components. Where these components are known, the earth fault loop impedance is calculated as follows.

Where the circuit concerned has conductors of cross-sectional area not exceeding 35 mm<sup>2</sup>:

$$Z_s = \sqrt{(R_E + R_1 + R_2)^2 + X_E^2} \text{ ohm}$$

or where the circuit concerned has conductors of cross-sectional area exceeding 35 mm<sup>2</sup>:

$$Z_s = \sqrt{(R_E + R_1 + R_2)^2 + (X_E + X_1 + X_2)^2} \text{ ohm}$$

In both the above expressions:

$R_E$  = resistance component of  $Z_E$ , ohm

$X_E$  = reactance component of  $Z_E$ , ohm.

Where the supply is three-phase,  $R_E$  and  $X_E$  are the per phase values.

## Calculations taking account of transformer impedance

### Example 3.14

A single-phase circuit is run in multicore non-armoured 90°C thermosetting insulated cable having copper conductors of 95 mm<sup>2</sup> cross-sectional area, its route length  $l = 20$  m. This circuit is fed from a 50 kVA distribution transformer having an internal resistance of 0.027 ohm and an internal reactance of 0.050 ohm (values obtained from the transformer manufacturer).

What is the earth fault loop impedance of the circuit at the normal operating temperature?

### Answer

To determine the earth fault loop impedance it is necessary to obtain the resistance and reactance values for the cable from the manufacturer, adjusting the former to the normal operating temperature.

As no information is given regarding the actual operating temperature of the phase conductor, the calculations are based on the assumption that the temperature is the maximum permitted normal operating temperature (90°C). The same temperature is assumed for the protective conductor.

The mV/A/m values in the voltage drop section of the tables in Appendix 4 of BS 7671 can be used as follows:

$$(R_1 + R_2) = \frac{(\text{mV/A/m})_r \times l}{1000} \text{ ohm}$$

$$(X_1 + X_2) = \frac{(\text{mV/A/m})_x \times l}{1000} \text{ ohm}$$

For the present case Table 4E2B applies and from this the  $(\text{mV/A/m})_r$  is found to be 0.50 milliohms/m and the  $(\text{mV/A/m})_x$  is 0.150 milliohms/m.

Thus:

$$(R_1 + R_2) = \frac{0.50 \times 20}{1000} \text{ ohm} = 0.010 \text{ ohm}$$

$$(X_1 + X_2) = \frac{0.150 \times 20}{1000} \text{ ohm} = 0.003 \text{ ohm}$$

$$\begin{aligned} Z_s &= \sqrt{(0.027 + 0.01)^2 + (0.050 + 0.003)^2} \text{ ohm} \\ &= \sqrt{0.00137 + 0.0028} \text{ ohm} \\ &= 0.065 \text{ ohm} \end{aligned}$$

### Example 3.15

A three-phase circuit is run in multicore non-armoured 70°C thermoplastic insulated cable having aluminium conductors of 70 mm<sup>2</sup>, its route length  $l = 45$  m. This circuit is fed from a three-phase transformer having an internal resistance of 0.005 ohm per phase and an internal reactance of 0.017 ohm per phase (values obtained from the transformer manufacturer).

What is the earth fault loop impedance at the remote end of the circuit?

**Answer**

As with the previous example, it is necessary to obtain the resistance and reactance values for the cable from the manufacturer, or alternatively use the mV/A/m values in the voltage drop section of the tables in Appendix 4 of BS 7671.

Again as no information is given regarding the actual operating temperature of the conductors, the calculations are based on the assumption that the temperature is the maximum permitted normal operating temperature (70°C).

Because the circuit is three-phase:

$$(R_1 + R_2) = \frac{2 \times (\text{mV/A/m})_r \times 1}{\sqrt{3} \times 1000} \text{ ohm}$$

$$(X_1 + X_2) = \frac{2 \times (\text{mV/A/m})_x \times 1}{\sqrt{3} \times 1000} \text{ ohm}$$

For the present case Table 4H2B applies and from this the  $(\text{mV/A/m})_r$  is found to be 0.9 milliohms/m and the  $(\text{mV/A/m})_x$  is 0.140 milliohms/m.

Thus:

$$(R_1 + R_2) = \frac{2 \times 0.9 \times 45}{\sqrt{3} \times 1000} \text{ ohm} = 0.0468 \text{ ohm}$$

$$(X_1 + X_2) = \frac{2 \times 0.14 \times 45}{\sqrt{3} \times 1000} \text{ ohm} = 0.0073 \text{ ohm}$$

$$\begin{aligned} Z_s &= \sqrt{(0.0468 + 0.005)^2 + (0.0073 + 0.017)^2} \text{ ohm} \\ &= \sqrt{0.0027 + 0.0006} \text{ ohm} \\ &= 0.057 \text{ ohm} \end{aligned}$$

**Calculations concerning circuits fed from sub-distribution boards**

Consider now the case where the final circuit concerned is fed from a sub-distribution board but again the installation is fed from the public low voltage network.

**Example 3.16**

In an installation which is part of a TN–C–S system, a final circuit is fed from a sub-distribution board. The distribution circuit from the main board to the sub-distribution board is run in single-core 70°C thermoplastic insulated cables having copper conductors, the live conductors being of 25 mm<sup>2</sup> cross-sectional area and the protective conductor 16 mm<sup>2</sup>, these being in trunking with cables of other circuits. The distance between the distribution boards is 27 m. The final circuit is run in 6 mm<sup>2</sup> flat twin (with cpc) 70°C thermoplastic insulated and sheathed cable,  $l = 22$  m. Protection against indirect contact is provided by a device of a type listed earlier in this chapter.

If  $Z_E = 0.35$  ohm, what is the earth fault loop impedance (a) at the sub-distribution board and (b) for the final circuit?

### Answer

Because of the absence of information on the ambient temperature and the design currents of the circuits, the simple method has to be used.

(a) For the distribution circuit Table 54.3 applies. From Table 3.1 Column 4  $(R_1 + R_2)/m$  is found to be 2.25 milliohms/m.

Thus  $Z_s$  at the sub-distribution board is:

$$0.35 + \frac{(2.25 \times 27)}{1000} \text{ ohm} = 0.41 \text{ ohm}$$

(b) For the final circuit Table 54.3 again applies. From Table 3.1 Column 4  $(R_1 + R_2)$  milliohms/m is found to be 12.6 milliohms/m (because the cpc is of  $2.5 \text{ mm}^2$  cross-sectional area).

For the final circuit:

$$(R_1 + R_2) = \frac{22 \times 12.6}{1000} \text{ ohm} = 0.28 \text{ ohm}$$

The designer has two options for calculating the earth fault loop impedance of the final circuit. The first of these is to add its  $(R_1 + R_2)$  value to the previously calculated earth fault loop impedance at the distribution board, giving:

$$(0.41 + 0.28) \text{ ohm} = 0.69 \text{ ohm}$$

This is a pessimistically high value because the 0.41 ohm at the sub-distribution board has assumed that the phase and protective conductors of the distribution circuit are at the maximum normal operating temperature ( $70^\circ\text{C}$  for thermoplastic insulation).

The temperature of the distribution circuit cable may be less than  $70^\circ\text{C}$ . The second option therefore is to estimate the initial temperature of the distribution circuit, say  $50^\circ\text{C}$ .

Using Table 3.3:

$$(R_1 + R_2) = \frac{(0.727 + 1.15) \times (230 + 50) \times 27}{1000 \times (230 + 20)} \text{ ohm}$$

$$= 0.057 \text{ ohm}$$

Thus  $Z_s$  for the final circuit is:

$$(0.35 + 0.057 + 0.28) \text{ ohm} = 0.69 \text{ ohm}$$

In this case there is no advantage over using the simple method.

If by using the simple method the resulting calculated earth fault loop impedances do not exceed the maximum values specified in BS 7671 for the overcurrent protective devices concerned, there is obviously no point whatsoever in proceeding to the more accurate approach.

Also, the  $(R_1 + R_2)$  value of the distribution circuit will be less, and in some cases considerably less, than that for a final circuit and therefore contributes little to the earth fault loop impedance of the latter.

In the following example sufficient information is available for either the simple method or the more rigorous one to be used.

### Example 3.17

In an installation which is part of a TN–C–S system, a single-phase distribution circuit from the main board to a sub-distribution board is run in single-core 90°C thermosetting insulated and sheathed cables, the live and protective copper conductors having a cross-sectional area of 35 mm<sup>2</sup>. The cables are clipped direct and not grouped with the cables of other circuits.  $I_b = 140\text{ A}$  and  $l = 30\text{ m}$ . A final circuit is taken from the sub-distribution board and is run in 4 mm<sup>2</sup> two-core (with cpc) 70°C thermoplastic insulated and sheathed cable having a cpc of 1.5 mm<sup>2</sup> cross-sectional area. The cable is clipped direct and is not bunched with other cables.  $I_b = 26\text{ A}$  and  $l = 20\text{ m}$ . Protection against indirect contact is provided by a device of a type listed earlier in this chapter.

If  $Z_E = 0.35\text{ ohm}$  and it can be assumed that the ambient temperature throughout the installation is the same as the reference value (30°C), determine the earth fault loop impedance (a) at the sub-distribution board and (b) for the final circuit.

### Answer

Using the simple method, first calculate  $(R_1 + R_2)$  for the distribution circuit. Table 54.2 applies.

From Table 3.1 Column 5,  $(R_1 + R_2)/\text{m}$  is found to be 1.22 milliohms/m.

Thus:

$$R_1 + R_2 = \frac{1.22 \times 30}{1000} \text{ ohm} = 0.037 \text{ ohm}$$

$Z_s$  at the sub-distribution board is given by:

$$(0.35 + 0.037) \text{ ohm} = 0.387 \text{ ohm}$$

Now calculate  $(R_1 + R_2)$  for the final circuit. Table 54.3 applies.

From Table 3.1 Column 4,  $(R_1 + R_2)/\text{m}$  is found to be 20.1 milliohms/m.

Thus:

$$(R_1 + R_2) = \frac{20.1 \times 20}{1000} \text{ ohm} = 0.402 \text{ ohm}$$

$Z_s$  for the final circuit is:

$$(0.387 + 0.402) \text{ ohm} = 0.789 \text{ ohm}$$

Now consider the more rigorous approach again taking the distribution circuit first.

From Table 4E1A Column 6 it is found that  $I_{ta} = 176\text{ A}$  for  $35\text{ mm}^2$  conductor cross-sectional area.

With  $I_b = 140\text{ A}$ :

$$t_1 = 30 + \left( \frac{140^2}{176^2} \times 60 \right) ^\circ\text{C} = 68^\circ\text{C}$$

From Tables 3.3 and 3.4, for under fault conditions:

$$R_1 = \frac{0.524 \times [0.92 + (0.004 \times 68)]}{1000} \times 30\text{ ohm} = 0.0187\text{ ohm}$$

$$R_2 = \frac{0.524 \times [0.92 + (0.004 \times 30)]}{1000} \times 30\text{ ohm} = 0.0163\text{ ohm}$$

$Z_s$  at the sub-distribution board is given by:

$$(0.35 + 0.0187 + 0.0163)\text{ohm} = 0.384\text{ohm}$$

It will be seen immediately that this value is effectively the same as that calculated by the simple method.

As regards the final circuit itself:

From Column 6 of Table 4D2A it is found that  $I_{ta}$  for  $4\text{ mm}^2$  cross-sectional area is  $36\text{ A}$ . Thus with  $I_b = 26\text{ A}$  the conductor operating temperature is given by:

$$30 + \left( \frac{26^2}{36^2} \times 40 \right) ^\circ\text{C} = 50.9^\circ\text{C}$$

Using Tables 3.3 and 3.4 then  $R_1$  is given by:

$$4.61 \times \frac{[0.92 + (0.004 \times 50.9)]}{1000} \times 20\text{ ohm} = 0.104\text{ ohm}$$

and  $R_2$  is given by:

$$12.1 \times \frac{[0.92 + (0.004 \times 50.9)]}{1000} \times 20\text{ ohm} = 0.272\text{ ohm}$$

Note that because the protective conductor is in the same cable as the live conductors, it is assumed that the former attains the same temperature as the latter.

$Z_s$  for the final circuit is given by:

$$(0.384 + 0.104 + 0.272)\text{ohm} = 0.76\text{ohm}$$

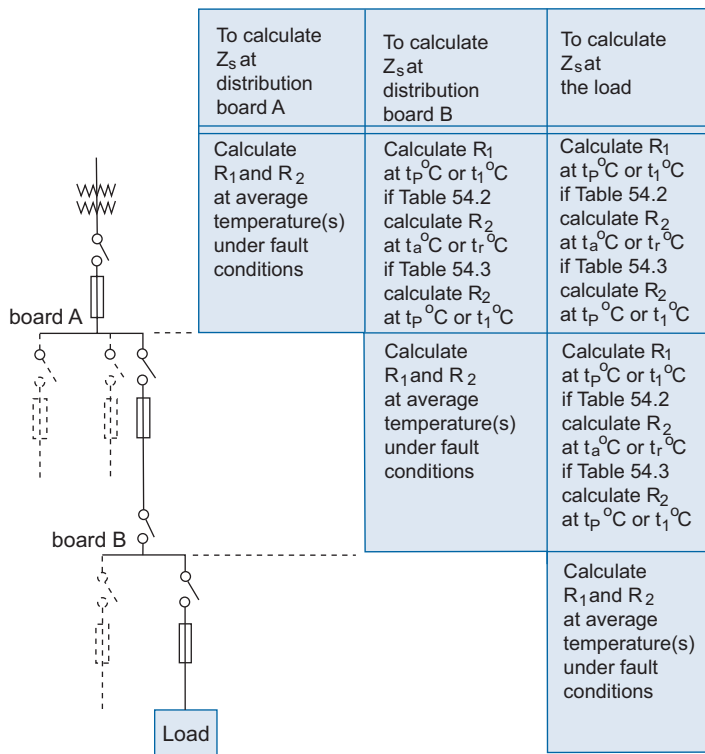

**Figure 3.1** Temperatures at which conductor resistances should be calculated when determining earth fault loop impedances.

It is a matter of personal judgement whether the more rigorous approach has been worthwhile. Certainly, had the simpler approach given impedance values less than the specified maximum there would be no advantage in then using the more rigorous method, as already indicated.

A simple approach to calculating earth fault loop impedance when the protective device is one of those listed earlier is to assume that all the conductors are at their maximum permitted normal operating temperature.

Where the protective device is not one of those listed earlier, the possible approaches are indicated in Figure 3.1. The following method is a compromise which has some merit where the protective device is not one of those listed earlier.

(a) To calculate the earth fault loop impedance at the sub-distribution board use the simple method based on Tables 3.1 and 3.2.

(b) To calculate the earth fault loop impedance for the final circuit, use the simple method to calculate its own ( $R_1 + R_2$ ) value. In calculating the contribution of the distribution circuit cable, base its ( $R_1 + R_2$ ) on the maximum permitted normal operating temperature for the cable insulation concerned and assume that any temperature rise due to an earth fault in the final circuit can be ignored. The temperature assumed for the protective conductor of the distribution circuit will depend on whether Table 54.2 or Table 54.3 applies.

**Example 3.18**

In an installation which is part of a TN–S system, a final circuit from a sub-distribution board is run, not bunched with other circuits, in single-core 90°C thermosetting insulated and sheathed cables having copper conductors, 6 mm<sup>2</sup> cross-sectional area for the live conductors and 2.5 mm<sup>2</sup> for the protective conductor.  $I_b = 33$  A and  $l = 28$  m.

The distribution circuit to the sub-distribution board is also run, not bunched with other circuits, in single-core 90°C thermosetting insulated and sheathed cables with copper conductors of 25 mm<sup>2</sup> cross-sectional area for the live and protective conductors. For this circuit  $l = 20$  m and  $I_b = 105$  A.  $Z_E$  is taken to be 0.8 ohm and the expected ambient temperature throughout the installation is 30°C.

What is the earth fault loop impedance for the final circuit?

**Answer**

Following the proposed compromise approach the  $(R_1 + R_2)$  contribution of the distribution circuit to the required earth fault loop impedance is calculated assuming that the circuit live conductors are operating at 90°C and, because Table 54.2 applies, its protective conductor is at the ambient temperature.

For the distribution circuit, from Table 3.1 Column 5:

$$(R_1 + R_2) = \frac{1.69 \times 20}{1000} = 0.0338$$

For the final circuit itself, from Table 3.1 Column 5 (because Table 54.2 again applies):

$$(R_1 + R_2) = \frac{11.6 \times 28}{1000} \text{ ohm} = 0.3248 \text{ ohm}$$

$Z_s$  for the final circuit is given by:

$$(0.8 + 0.0338 + 0.3248) \text{ ohm} = 1.16 \text{ ohm}$$

**Calculations where conduit or trunking is used as the protective conductor**

Regulation 543.2.2 lists those items which may be used as protective conductors and amongst these are:

- (a) the metallic sheaths, screens and armouring of cables;
- (b) metallic conduits or other enclosures for conductors.

Item (a) includes the sheaths of mineral-insulated cables and item (b) obviously includes trunking and ducting. All these items exhibit more than adequate thermal capacity under earth fault conditions, but there is a particular problem associated with these when it comes to assessing their contribution to the earth fault loop impedance of a circuit.

For mineral-insulated cables the cross-sectional area of the sheath is greater than, and in many cases considerably greater than, that of the associated live conductor and it would be unreasonable to assume that under earth fault conditions the sheath would attain the same temperature as the live conductor.

When intending to use mineral-insulated cables, the manufacturer of the cables should be consulted regarding the values of  $(R_1 + R_2)$  per metre under fault conditions.

Consider now the case where the circuit protective conductor is metallic conduit.

The basic problem when calculating the contribution of the conduit to earth fault loop impedance is that the impedance of the conduit varies with the magnitude of the fault currents. It rises to a peak between 50 A and 70 A and then decreases, the peak value being of the order of three times the d.c. resistance. It is therefore logical to adopt two values of the impedance of the circuit, one for fault currents up to 100 A and the other for fault currents in excess of 100 A.

A further problem with steel conduit is that its contribution to the earth fault loop impedance has both resistive and reactive components, the impedance angle being about  $33^\circ$ . However, since the available conduit impedances are based on empirical values and are likely to vary depending on the magnetic properties of the steel, for most purposes it is sufficiently accurate to add the conduit impedance to the conductor resistance.

The method is to first calculate the fault current using the higher of the impedance values, i.e. that for fault current up to 100 A. Should the result be less than 100 A the contribution of the conduit to the earth fault loop impedance is as calculated. Should the result be greater than 100 A the conduit contribution has to be recalculated using the lower value of the impedance in the relevant table.

Tables 3.6 and 3.7 give the impedance values in milliohms/metre for light gauge and heavy gauge conduit, respectively.

It is of course necessary, when determining the earth fault loop impedance, to calculate the resistance of the phase conductor and to do this the values given in Table 3.1 are used, if that conductor is of copper, or Table 3.2 when of aluminium. Alternatively Tables 3.3 or 3.4 may be used if 'correcting' the phase conductor resistance for operating temperature.

If the designer intends to use supplementary equipotential bonding, in accordance with Regulation 415.2, as the method of compliance with the requirements for automatic disconnection Regulation 411.3.2.6 the values given in Table 3.8 should be used to determine the contribution of the conduit to the R value of Regulation 415.2.2.

The values in Tables 3.6, 3.7 and 3.8 may be assumed to be independent of temperature.

**Table 3.6** Contribution of light gauge conduit to earth fault loop impedance

Nominal conduit size, mm	Conduit impedance, milliohms/m	
	When $I_{ef} \leq 100$ A	When $I_{ef} > 100$ A
1	2	3
16	7.8	5.0
20	5.4	4.0
25	3.5	2.2
32	2.4	1.5

**Table 3.7** Contribution of heavy gauge conduit to earth fault loop impedance

Nominal conduit size, mm	Conduit impedance, milliohms/m	
	When $I_{ef} \leq 100$ A	When $I_{ef} > 100$ A
1	2	3
16	7.6	3.8
20	4.7	2.5
25	3.2	1.7
32	2.0	1.1

**Table 3.8** Impedance of conduit related to Regulation 425.2.2 of BS 7671

Nominal conduit size, mm	Conduit impedance, milliohms/m	
	Light gauge	Heavy gauge
1	2	3
16	2.8	2.1
20	2.2	1.4
25	1.5	1.1
32	1.1	0.85

If it is considered necessary to deal with the resistive and reactive components of the conduit impedance independently, then values of  $R_2$  and  $X_2$  can be obtained from the impedances given in Tables 3.6 and 3.7 as follows:

$$\text{when } I_{ef} \leq 100 \text{ A, } R_2 = 0.83Z_2 \text{ and } X_2 = 0.56Z_2;$$

$$\text{when } I_{ef} > 100 \text{ A, } R_2 = 0.71Z_2 \text{ and } X_2 = 0.71Z_2.$$

### Example 3.19

A 230 V single-phase circuit is run in 6 mm<sup>2</sup> single-core 70°C thermoplastic insulated cables, having copper conductors in 25 mm metallic light gauge conduit and protection against indirect contact is provided by the overcurrent protective device which is a 32 A BS 88-2.2 'gG' fuse.

If  $l = 20$  m and  $Z_E = 0.35$  ohm, check that the circuit meets the maximum disconnection time of 5 s.

### Answer

From Table 3.1 Column 3,  $R_1 = 3.70$  milliohms/m. From Table 3.6 Column 2, the conduit contribution to  $Z_s$  is 3.5 milliohms/m.

Thus:

$$(R_1 + Z_2) = \frac{(3.70 + 3.5)}{1000} \times 20 \text{ ohm} = 0.144 \text{ ohm}$$

$$Z_s = (0.144 + 0.35) \text{ ohm} = 0.494 \text{ ohm}$$

$$I_{ef} = \frac{230}{0.494} \text{ A} = 466 \text{ A}$$

As  $I_{ef} > 100 \text{ A}$ ,  $Z_s$  has to be recalculated, the conduit contribution, from Column 3 of Table 3.6, being reduced to 2.2 milliohms/m.

Thus:

$$(R_1 + Z_2) = \frac{(3.70 + 2.2)}{1000} \times 20 \text{ ohm} = 0.118 \text{ ohm}$$

$$Z_s = (0.118 + 0.35) \text{ ohm} = 0.47 \text{ ohm}$$

The maximum value of  $Z_s$  (from Table 41.4) for 5 s disconnection time is 1.84 ohm so the circuit complies.

It is important to note that if there are other circuits in the conduit, as there might well be, each circuit has to be checked.

### Example 3.20

A 400 V three-phase circuit is run in 4 mm<sup>2</sup> single-core 90°C thermosetting insulated cables having copper conductors in 32 mm light gauge metallic conduit and protection against indirect contact is provided by the overcurrent protective devices which are 20 A Type B mcbs.

If  $l = 45 \text{ m}$  and  $Z_E = 0.8 \text{ ohm}$ , check the circuit meets the maximum disconnection time of 0.4 s.

### Answer

From Table 3.1 Column 5,  $R_1/m = 5.90 \text{ milliohms/m}$ . From Table 3.6 Column 2, the conduit contribution to  $Z_s$  is 2.4 milliohms/m.

Thus:

$$(R_1 + Z_2) = \frac{(5.90 + 2.4)}{1000} \times 45 = 0.374 \text{ ohm}$$

$$Z_s = (0.374 + 0.8) \text{ ohm} = 1.174 \text{ ohm}$$

$$\text{As } U_o = 230 \text{ V, } I_{ef} = \frac{230}{1.174} \text{ A} = 196 \text{ A}$$

Because this is greater than 100 A it is necessary to recalculate  $Z_s$ , the conduit contribution from Column 3 of Table 3.6 being reduced to 1.5 milliohms/m.

$$(R_1 + Z_2) = \frac{(5.90 + 1.5)}{1000} \times 45 \text{ ohm} = 0.333 \text{ ohm}$$

$$Z_s = (0.333 + 0.8) \text{ ohm} = 1.133 \text{ ohm}$$

From Table 41.3 the maximum value of  $Z_s$  for a disconnection time of 0.4 s is found to be 2.3 ohm so the circuit complies.

Note that in Table 41.3 the same value of earth fault loop impedance applies to both 0.4 s and 5 s maximum disconnection times for mcbs. This is because the impedance values are based on the so-called instantaneous disconnection time of 0.1 s.

BS 7671, however, allows the designer to adopt a different value of maximum permitted earth fault loop impedance for 0.4 s disconnection compared with that for 5 s where the characteristic of the circuit breaker is such that this differentiation can be made, but the examples used throughout this book are based on the 0.1 s disconnection time values.

### Example 3.21

A 400 V three-phase circuit is run in 6 mm<sup>2</sup> single-core 70°C thermosetting insulated cables having copper conductors in 16 mm light gauge metallic conduit and protection against indirect contact is provided by the overcurrent protective devices which are 25 A BS 88–2.2 ‘gG’ fuses.

If  $l = 85 \text{ m}$  and  $Z_E = 0.8 \text{ ohm}$ , check the circuit meets the maximum disconnection time of 0.4 s.

### Answer

From Table 3.1 Column 3,  $R_1/\text{m} = 3.70 \text{ milliohms/m}$ . From Table 3.6 Column 2 the conduit contribution to  $Z_s$  is 7.8 milliohms/m.

Thus:

$$(R_1 + Z_2) = \frac{(3.70 + 7.8)}{1000} \times 85 \text{ ohm} = 0.98 \text{ ohm}$$

$$Z_s = (0.98 + 0.8) \text{ ohm} = 1.78 \text{ ohm}$$

This exceeds the maximum permitted value of 1.44 ohm given in Table 41.2 for 0.4 s disconnection time.

But the earth fault current is given by:

$$I_{ef} = \frac{230}{1.78} \text{ A} = 129 \text{ A}$$

Because this is greater than 100 A it is necessary to recalculate  $Z_2$  and from Table 3.6 Column 3 it is found that the original value of 7.8 milliohms/m is reduced to 5 milliohms/m with fault currents in excess of 100 A.

The 'corrected'  $(R_1 + Z_2)$  is then given by:

$$\frac{(3.70 + 5)}{1000} \times 85 \text{ ohm} = 0.74 \text{ ohm}$$

and the 'corrected'  $Z_s$  is

$$(0.74 + 0.8) \text{ ohm} = 1.54 \text{ ohm.}$$

The 'corrected value' is nevertheless still greater than the permitted maximum value of 1.44 ohm. The disconnection time could be increased to 5 s, however, provided that supplementary equipotential bonding in accordance with regulation 415.2 is applied.

Where trunking is used as the cpc a similar approach to that used for conduit is suggested, except that instead of the changeover point being based on the earth fault current it is based on the design current for the circuit. This is because it is considered that trunking is not suitable as a cpc for circuits carrying more than 100 A unless particular attention is paid to the joints between sections of trunking. As with conduit, the impedance of trunking has both resistive and reactive components, but for most purposes it is considered sufficiently accurate to add the trunking impedance to the conductor resistance. Table 3.9 gives the trunking contribution to the earth fault loop impedance and Table 3.10 gives the trunking impedance relative to Regulation 415.2.2.

**Table 3.9** Contribution of trunking to earth fault loop impedance

Nominal trunking size, mm × mm	Trunking impedance, milliohms/m			
	When $I_b \leq 100 \text{ A}$		When $I_b > 100 \text{ A}$	
	$R_2$	$X_2$	$Z_2$	$Z_2$
1	2	3	4	5
50 × 38	2.23	2.12	3.08	2.13
50 × 50	1.85	1.76	2.55	1.77
75 × 50	1.32	1.26	1.82	1.26
75 × 75	1.03	0.98	1.42	0.98
100 × 50	1.16	1.10	1.60	1.10
100 × 75	0.94	0.88	1.29	0.88
100 × 100	0.65	0.62	0.90	0.63
150 × 50	0.80	0.76	1.10	0.76
150 × 75	0.65	0.62	0.90	0.63
150 × 100	0.48	0.46	0.66	0.46
150 × 150	0.38	0.36	0.52	0.37

**Table 3.10** Impedance of trunking relating to Regulation 415.2.2 of BS 7671

Nominal trunking size, mm × mm	Trunking impedance, milliohms/m
1	2
50 × 38	1.06
50 × 50	0.88
75 × 50	0.63
75 × 75	0.49
100 × 50	0.55
100 × 75	0.44
100 × 100	0.31
150 × 50	0.38
150 × 75	0.31
150 × 100	0.23
150 × 150	0.18

**Example 3.22**

A 230 V single-phase circuit is run in 16 mm<sup>2</sup> single-core 90°C thermosetting insulated cable having copper conductors in 75 mm × 50 mm trunking. Protection against indirect contact is provided by the overcurrent protective device which is a 63 A BS 88–2.2 ‘gG’ fuse.

If  $l = 35$  m and  $Z_e = 0.35$  ohm, check the circuit meets the maximum disconnection time of 5 s.

**Answer**

From Table 3.1 Column 5,  $R_1/m$  is 1.47 milliohms/m. From Table 3.9 Column 4 the contribution to the circuit  $Z_s$  is 1.82 milliohms/m.

Thus:

$$(R_1 + Z_2) = \frac{(1.47 + 1.82)}{1000} \times 35 \text{ ohm} = 0.115 \text{ ohm}$$

$$Z_s = (0.115 + 0.35) \text{ ohm} = 0.465 \text{ ohm}$$

As this is less than the maximum permitted value of 0.82 ohm given in Table 41.4, the circuit complies. If the more accurate approach of using  $R_2$  and  $X_2$  is adopted then  $Z_s$  is again 0.46 ohm.

## Calculations where cable armouring is used as the protective conductor

Finally in this present chapter consider the case where the cable armouring is used as the cpc.

Standards for armoured cables give resistance values based on 20°C for both the line conductors and the steel wire armouring. These resistance values for line conductors of up to and including 35 mm<sup>2</sup> cross-sectional area are given in Table 3.3 for both copper and aluminium.

The d.c. resistance values, given in the cable standards, for the steel wire armouring are multiplied by a factor of 1.1 to give the a.c. armour resistance, at 20°C, used in the calculation of the earth fault loop impedance. These increased values are given in Tables 3.11 to 3.14 and it will be seen that for cables of 50 mm<sup>2</sup> and greater cross-sectional area, a reactance of 0.3 milliohms/m is applicable as the reactive contribution of an armoured cable to the earth fault loop impedance.

To determine the contribution of the live conductor and the armouring to the earth fault loop impedance, the conductor resistance is corrected to the assumed temperature under earth fault conditions.

**Table 3.11** Impedance of steel wire armouring for 70°C thermoplastic insulated cables having stranded copper conductors at 20°C in milliohms/metre

Conductor cross-sectional area, mm <sup>2</sup>	Two-core		Three-core		Four-core (equal)		Four-core (reduced neutral)	
	R	X	R	X	R	X	R	X
1	2	3	4	5	6	7	8	9
1.5	10.7	—	10.2	—	9.5	—	—	—
2.5	9.1	—	8.8	—	7.9	—	—	—
4	7.5	—	7.0	—	4.6	—	—	—
6	6.8	—	4.6	—	4.1	—	—	—
10	3.9	—	3.7	—	3.4	—	—	—
16	3.5	—	3.2	—	2.2	—	—	—
25	2.6	—	2.4	—	2.1	—	2.1	—
35	2.4	—	2.1	—	1.9	—	1.9	—
50	2.1	0.3	1.9	0.3	1.3	0.3	1.7	0.3
70	1.9	0.3	1.4	0.3	1.2	0.3	1.2	0.3
95	1.3	0.3	1.2	0.3	0.98	0.3	1.0	0.3
120	1.2	0.3	1.1	0.3	0.71	0.3	0.73	0.3
150	1.1	0.3	0.74	0.3	0.65	0.3	0.67	0.3
185	0.78	0.3	0.68	0.3	0.59	0.3	0.60	0.3
240	0.69	0.3	0.60	0.3	0.52	0.3	0.54	0.3
300	0.63	0.3	0.54	0.3	0.47	0.3	0.49	0.3
400	0.56	0.3	0.49	0.3	0.34	0.3	0.35	0.3

**Table 3.12** Impedance of steel wire armouring of 70°C thermoplastic insulated cables having sector shaped solid aluminium conductors at 20°C in milliohms/metre

Conductor cross-sectional area, mm <sup>2</sup>	Two-core		Three-core		Four-core	
	R	X	R	X	R	X
1	2	3	4	5	6	7
16	3.7	—	3.4	—	2.4	—
25	2.9	—	2.5	—	2.3	—
35	2.7	—	2.3	—	2.0	—
50	2.4	0.3	2.0	0.3	1.4	0.3
70	2.1	0.3	1.4	0.3	1.3	0.3
95	1.5	0.3	1.3	0.3	1.1	0.3
120	—	—	1.2	0.3	0.78	0.3
150	—	—	0.82	0.3	0.71	0.3
185	—	—	0.73	0.3	0.64	0.3
240	—	—	0.65	0.3	0.57	0.3
300	—	—	0.59	0.3	0.52	0.3

Similarly the armour resistance is corrected to 60°C for 70°C thermoplastic insulated cables and 80°C for cables with thermosetting insulation and the temperatures are assumed to remain the same under earth fault conditions. The reactance value is independent of temperature.

For cables of 50 mm<sup>2</sup> and greater cross-sectional area, it is suggested that the mV/A/m<sub>r</sub> values given in Appendix 4 of BS 7671 are used, as shown in earlier examples, to determine the contribution of the phase conductor resistance to the earth fault loop impedance.

### Example 3.23

A single-phase circuit is run in two-core armoured 70°C thermoplastic insulated cable having copper conductors of 4 mm<sup>2</sup> cross-sectional area and protected by a BS 88–2.2 fuse.

If  $l = 34$  m and  $Z_e = 0.35$  ohm, calculate the earth fault loop impedance.

### Answer

From Table 3.1 Column 3,  $R_1/m = 5.53$  milliohms/m.

$R_1$  is given by:

$$R_1 = \frac{5.53 \times 34}{1000} \text{ ohm} = 0.188 \text{ ohm}$$

From Table 3.11 Column 2, the armour resistance is 7.5 milliohms/m at 20°C.

**Table 3.13** Impedance of steel wire armouring for cables having 90°C thermosetting insulation and stranded copper conductors at 20°C in milliohms/metre.

Conductor cross-sectional area, mm <sup>2</sup>	Two-core		Three-core		Four-core (equal)		Four-core (reduced neutral)	
	R	X	R	X	R	X	R	X
1	2	3	4	5	6	7	8	9
1.5	9.4	—	9.1	—	8.5	—	—	—
2.5	8.8	—	8.2	—	7.7	—	—	—
4	7.9	—	7.5	—	6.8	—	—	—
6	7.0	—	6.6	—	4.3	—	—	—
10	6.0	—	4.0	—	3.7	—	—	—
16	3.8	—	3.6	—	3.2	—	—	—
25	3.7	—	2.5	—	2.3	—	2.3	—
35	2.5	—	2.3	—	2.0	—	2.1	—
50	2.3	0.3	2.0	0.3	1.8	0.3	1.9	0.3
70	2.0	0.3	1.8	0.3	1.2	0.3	1.3	0.3
95	1.4	0.3	1.3	0.3	1.1	0.3	1.1	0.3
120	1.3	0.3	1.2	0.3	0.76	0.3	0.96	0.3
150	1.2	0.3	0.78	0.3	0.68	0.3	0.71	0.3
185	0.82	0.3	0.71	0.3	0.61	0.3	0.63	0.3
240	0.73	0.3	0.63	0.3	0.54	0.3	0.56	0.3
300	0.67	0.3	0.58	0.3	0.49	0.3	0.52 <sup>a</sup>	0.3
							0.49 <sup>b</sup>	
400	0.59	0.3	0.52	0.3	0.35	0.3	0.46	0.3

<sup>a</sup> With 150 mm<sup>2</sup> neutral.

<sup>b</sup> With 185 mm<sup>2</sup> neutral.

The armour resistance at 60°C is given by:

$$\frac{7.5 \times 34 \times 1.18}{1000} \text{ ohm} = 0.3 \text{ ohm}$$

The earth fault loop impedance is given by:

$$Z_s = (0.35 + 0.188 + 0.3) \text{ ohm} = 0.838 \text{ ohm}$$

**Table 3.14** Impedance of steel wire armouring for cables having 90°C thermosetting insulation and solid aluminium conductors at 20°C in milliohms/metre

Conductor cross-sectional area, mm <sup>2</sup>	Two-core		Three-core		Four-core	
	R	X	R	X	R	X
1	2	3	4	5	6	7
16	3.9	—	3.7	—	3.4	—
25	3.1	—	2.7	—	2.4	—
35	2.9	—	2.5	—	2.2	—
50	2.6	0.3	2.2	0.3	1.9	0.3
70	2.3	0.3	1.9	0.3	1.3	0.3
95	1.6	0.3	1.3	0.3	1.2	0.3
120	—	—	1.2	0.3	0.82	0.3
150	—	—	0.86	0.3	0.74	0.3
185	—	—	0.76	0.3	0.66	0.3
240	—	—	0.69	0.3	0.59	0.3
300	—	—	0.63	0.3	0.54	0.3

The factors for adjusting the 20°C resistance values to other temperatures for earth fault loop impedance calculations are:

- Phase conductors – adjust to maximum permitted normal operating temperature:
  - 1.20 for 70°C thermoplastic insulated conductors
  - 1.28 for 90°C thermosetting insulated conductors
- Phase conductors – adjust to average of working and maximum permitted final temperature:
  - 1.38 for 70°C thermoplastic insulated conductors, 1.34 for conductors greater than 300 mm<sup>2</sup>
  - 1.60 for 90°C thermosetting insulated conductors
- Steel-wire armour:
  - 1.18 for the steel-wire armour of 70°C thermoplastic insulated cables
  - 1.27 for the steel-wire armour of 90°C thermosetting insulated cables.

### Example 3.24

A three-phase circuit is run in 16 mm<sup>2</sup> three-core armoured 90°C thermosetting insulated cable having aluminium conductors. The protection against indirect contact is provided by the overcurrent protective device which is a 50 A Type B mcb (TP & N).

If  $l = 42$  m,  $R_E = 0.25$  ohm and  $X_E = 0.20$  ohm, check that the circuit earth fault loop impedance does not exceed 0.92 ohm as given in Table 41.3.

### Answer

From Table 4J4B Column 4, mV/A/m = 4.2 milliohms/m (at 90°C).

$$R_1 = \frac{4.2 \times 42}{\sqrt{3} \times 1000} \text{ ohm} = 0.102 \text{ ohm}$$

From Table 3.14 Column 4:

$$R_2 \text{ at } 80^\circ\text{C} = \frac{3.7 \times 1.27 \times 42}{1000} \text{ ohm} = 0.197 \text{ ohm}$$

Thus:

$$\begin{aligned} Z_s &= \sqrt{(0.25 + 0.102 + 0.197)^2 + 0.20^2} \text{ ohm} \\ &= 0.584 \text{ ohm} \end{aligned}$$

The circuit therefore complies.

### Example 3.25

A single-phase circuit is run in 50mm<sup>2</sup> two-core armoured 90°C thermosetting insulated cable having copper conductors. The protection against indirect contact is provided by the overcurrent protective device which is a 160 A BS 88–2.2 ‘gG’ fuse.

If  $l = 45 \text{ m}$ ,  $R_E = 0.08 \text{ ohm}$  and  $X_E = 0.13 \text{ ohm}$ , check that the circuit earth fault loop impedance does not exceed 0.25 ohm (as given in Table 41.4 for 5 s disconnection time).

### Answer

From Table 4E4B Column 3,  $(\text{mV}/\text{A}/\text{m})_r = 0.99 \text{ milliohms}/\text{m}$  at 90°C.

$$R_1 = \frac{0.99 \times 45}{2 \times 1000} \text{ ohm} = 0.022 \text{ ohm}$$

From Table 3.13 Columns 2 and 3 for the armouring:

$$R_2/\text{m} = 2.3 \text{ milliohms}/\text{m} \text{ at } 20^\circ\text{C}$$

$$R_2 \text{ at } 80^\circ\text{C} = \frac{2.3 \times 1.27 \times 45}{1000} \text{ ohm} = 0.131 \text{ ohm}$$

$$X_2/\text{m} = 0.3 \text{ milliohms}/\text{m}$$

$$X_2 = \frac{0.30 \times 45}{1000} \text{ ohm} = 0.0135 \text{ ohm}$$

Thus:

$$\begin{aligned} Z_s &= \sqrt{(0.08 + 0.022 + 0.131)^2 + (0.13 + 0.0135)^2} \text{ ohm} \\ &= 0.274 \text{ ohm} \end{aligned}$$

The circuit therefore does not comply. This leaves the designer with a number of options. These include:

- increasing the cable size;
- repeating the calculation using the operating temperature of the cable instead of the maximum permitted operating temperature;
- installing a supplementary circuit protective conductor in parallel with the armour of the cable.

For the purpose of this example the third option is chosen, the addition of a supplementary cpc.

Work was commissioned by ECA, and carried out by ERA Technology, to develop equations for calculating the earth loop impedance when an external cpc is run in parallel with the armour of a multicore cable. This work has shown that the resistance,  $R_p$ , of the parallel combination is given by:

$$R_p = \frac{1}{\frac{1}{1.1 \times R_a} + \frac{1}{R_{cpc}}}$$

and the contribution of the armoured cable with an external cpc to the reactance of the loop impedance is 0.4 milliohms/m.

In this example:

$$X_1 = \frac{0.40 \times 45}{1000} \text{ ohm} = 0.018 \text{ ohm}$$

hence:

$$Z_s = \sqrt{(0.08 + 0.022 + R_p)^2 + (0.13 + 0.018)^2} \text{ ohm}$$

$$Z_s = \sqrt{(0.102 + R_p)^2 + 0.022} \text{ ohm}$$

For  $Z_s = 0.25$  this equation can be rearranged to give:

$$0.25^2 = (0.102 + R_p)^2 + 0.022$$

$$0.0625 - 0.022 = (0.102 + R_p)^2$$

$$0.201 - 0.102 = R_p = 0.099 \text{ ohm}$$

The armour resistance as given above is 0.131 ohms. The following equation is then rearranged to determine  $R_{cpc}$ :

$$0.099 = \frac{1}{\frac{1}{0.131} + \frac{1}{R_{cpc}}}$$

$$R_{\text{cpc}} = 0.405 \text{ ohms} = \frac{0.405}{45} \times 1000 = 9 \text{ milliohms/m}$$

Thus the external cpc should be selected such that its resistance at the operating temperature of the surface of the multicore cable is not more than 9 milliohm/m. Rather than calculate the temperature of the external cpc, it is safe to assume it is at the maximum conductor temperature of the main cable, 90°C in this example. The conductor size for the cpc can then be selected by examining Column 5 of Table 3.1. This results in a 4 mm<sup>2</sup> external cpc having a resistance of 5.9 milliohm/m.

The work commissioned by ECA also concluded that it was necessary to check that the selected external cpc has the required fault current capacity in accordance with Chapter 54 of BS7671. It has been proposed that a simple rule, that the cross-sectional area of the external cpc is not less than a quarter of that of the line conductor, is adopted.

Rather than carry out the detailed calculation given above it is simpler to apply the quarter size rule first and calculate if the conductor size thus selected will achieve the required fault loop impedance.

For this example the line conductor is 50 mm<sup>2</sup> so the minimum acceptable size for an external cpc is 16 mm<sup>2</sup>.

From Table 3.1 Column 5  $R_{\text{cpc}} = 1.47 \text{ milliohms/m}$

$$R_{\text{cpc}} = \frac{1.47 \times 45}{1000} \text{ ohm} = 0.066 \text{ ohm}$$

$$R_{\text{p}} = \frac{1}{\frac{1}{0.131} + \frac{1}{0.066}} = 0.044 \text{ ohm}$$

$$Z_{\text{s}} = \sqrt{(0.08 + 0.022 + 0.044)^2 + (0.13 + 0.018)^2} \text{ ohm}$$

$$= 0.208 \text{ ohm}$$

Thus the circuit complies with a 16 mm<sup>2</sup> external cpc connected in parallel with the armour.



# 4

## Calculations concerning protective conductor cross-sectional area

The designer having calculated the earth fault loop impedances for the various circuits in an installation must then check that the calculated values do not exceed the maximum specified in BS 7671.

In those cases where the protective device concerned is not one for which BS 7671 gives a maximum value, the calculated value must be such that the specified maximum disconnection time for the circuit is not exceeded.

In BS 7671 the term 'Fault current' covers both faults to earth and faults between live conductors. To differentiate between these two types of fault in the following chapters the term 'earth fault' will be used to denote a fault to earth and the term 'short circuit' will be used to denote a fault between live conductors.

The next stage is to check that the protective conductors meet the thermal requirements prescribed in Chapter 54 of BS 7671. The key regulation is Regulation 543.1.1 which states that every protective conductor, other than any equipotential bonding conductor, shall either be subject to calculation using the adiabatic equation of Regulation 543.1.3 or selected in accordance with Table 54.7.

If the overcurrent protective device, in addition to providing protection against electric shock under fault conditions (fault protection), is also providing short circuit protection but not overload protection, the adiabatic equation must be used. This requirement applies even if the protective conductor cross-sectional area does comply with Table 54.7.

Example 4.1 illustrates this particular point.

### Example 4.1

A single-phase 230 V circuit is 30 m long and is run in a 4 mm<sup>2</sup> circular 70°C thermoplastic insulated and sheathed cable clipped direct having copper conductors. The circuit is taken from a sub-distribution board where the calculated prospective short circuit current is 8000 A. The overcurrent protective device is a 63 A BS 88-2.2 'gG' fuse intended to provide short circuit protection and fault protection only. The earth fault loop impedance at the sub-distribution board has been calculated to be 0.45 ohm.

Check that the circuit complies with Regulation 543.1.1.

**Answer**

Because the fuse is intended to give short circuit protection only, the requirements of the Regulations in Section 434 of BS 7671 are applicable. These regulations require the protective device to have adequate breaking capacity and to interrupt the flow of fault current within a time such that the permitted limiting temperature of any conductor is not exceeded. There are no requirements in this section that relate the nominal rating of the device to the steady state rating of the cables used in the circuit. Thus the nominal current of the fuse can be greater than  $I_{ta}$ , which because no correction factors apply, is also  $I_z$ , the effective current-carrying capacity.

The prospective short circuit current at the sub-distribution board has been calculated to be 8000 A.

Thus:

$$Z \text{ phase/neutral} = \frac{230}{8000} \text{ ohm} = 0.029 \text{ ohm}$$

The phase/neutral impedance of the circuit itself (as will be explained in Chapter 5), can be found using Table 3.1 and, as short circuit conditions are being considered, Column 4 of that table applies.

The phase/neutral impedance of the circuit, therefore, is given by:

$$\frac{11.06}{1000} \times 30 \text{ ohm} = 0.332 \text{ ohm}$$

Thus the short circuit current with the fault occurring at the remote end of the circuit is given by:

$$\frac{230}{0.332 + 0.029} \text{ A} = 637 \text{ A}$$

From the time/current characteristic for the fuse, as given in Appendix 3 of BS 7671, it is found that the disconnection time is approximately 0.17 s.

From the adiabatic equation, Regulation 434.5.2 of BS 7671, the maximum disconnection time that can be tolerated is given by:

$$t = \frac{k^2 S^2}{I^2} \text{ s} = \frac{115^2 \times 4^2}{637^2} \text{ s} = 0.52 \text{ s}$$

The circuit conductors are therefore adequately protected thermally under short circuit conditions.

Consider now the earth fault condition. The  $(R_1 + R_2)$  for the circuit is again 0.332 ohm because Table 54.3 applies. Thus the earth fault loop impedance for the circuit is:

$$(0.332 + 0.45) \text{ ohm} = 0.782 \text{ ohm.}$$

The maximum disconnection time under earth fault conditions is 5 s, from Regulation 411.3.2.3. From Table 41.4 the maximum earth fault loop impedance for a 63 A BS 88 ‘gG’ fuse is found to be 0.82 ohm. Thus as far as disconnection time is concerned the circuit complies.

The earth fault current is given by:

$$\frac{230}{0.782} \text{ A} = 294 \text{ A}$$

Again from the time/current characteristic for the 63 A fuse, the disconnection time is found to be approximately 4 s. But from the adiabatic equation the maximum disconnection time that can be tolerated is given by:

$$t = \frac{k^2 S^2}{I_{cf}^2} \text{ s} = \frac{115^2 \times 4^2}{294^2} \text{ s} = 2.45 \text{ s}$$

Thus the circuit is not protected thermally in the event of an earth fault. So that although the circuit meets Table 54.7, the earth fault loop impedance limitation and the requirements of Regulation 434.5.2 as regards the short circuit withstand capability of the conductors, it does not meet the requirements of Regulation 434.5.2 for the earth fault condition. Hence the requirement in Regulation 543.1.1 that where the overcurrent protective device is providing short circuit protection and not overload protection, the designer must check compliance with the adiabatic equation.

This example is readily illustrated by Figure 4.1 which shows the adiabatic line for a 4 mm<sup>2</sup> conductor cross-sectional area and a k of 115 superimposed on the time/current characteristic for the fuse.

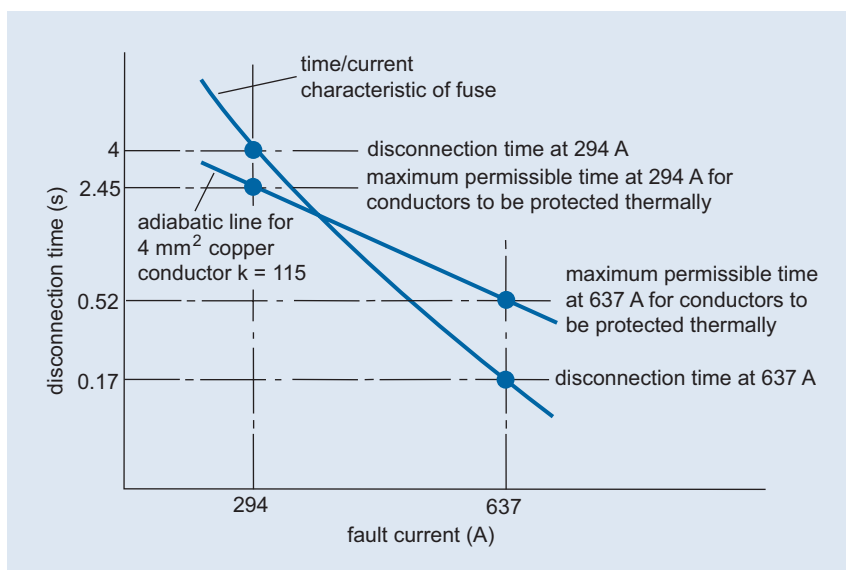

**Figure 4.1** Showing how a phase conductor protected thermally under short circuit conditions is not protected when an earth fault current of lower magnitude flows.

Example 4.1 has illustrated a particular case, but for the more general case where the overcurrent protective device is providing **overload** protection – with or without short circuit protection – the first stage should be to check if the protective conductor it is intended to use complies with Table 54.7.

If it does so, the designer is allowed to presume that the circuit conductors are adequately protected thermally in the event of an earth fault without the need to check against the adiabatic equation. For example, with mineral-insulated cables of the multicore type, the sheath cross-sectional area is considerably in excess of that demanded by Table 54.7. Similarly for single-core mineral-insulated cables where the sheaths are paralleled, the effective sheath cross-sectional area meets Table 54.7.

BS 7671 permits the use of metallic conduit, ducting and trunking as circuit protective conductors and where these enclosures are used for this purpose it will be found that their cross-sectional areas meet Table 54.7.

For instance, where the phase conductor has a cross-sectional area up to and including  $16\text{ mm}^2$ , the minimum cross-sectional area of the enclosure has to be  $k_1/k_2$  times that of the conductor where  $k_1$  is the  $k$  value for the conductor from Table 54.3 (which is the same as that given in Table 43.1) and  $k_2$  is the value of  $k$  for the enclosure from Table 54.5. Thus for  $70^\circ\text{C}$  thermoplastic insulated copper conductors in steel enclosures, the cross-sectional area of the latter has to be only 2.45 times that of the conductor to meet Table 54.7. Similarly the factor is 2.47 times for  $90^\circ\text{C}$  thermosetting insulated copper conductors in steel enclosures.

Similarly for armoured  $70^\circ\text{C}$  thermoplastic insulated cables where the armour is being used as the circuit protective conductor, it will be found that the cross-sectional area of the armour will often comply with Table 54.7. For  $90^\circ\text{C}$  thermosetting insulated cables it is found that more than half of the range of two-core and three-core cables do not meet the requirements of Table 54.7. However, detailed calculations in accordance with Regulation 543.1.3 for armoured  $90^\circ\text{C}$  thermosetting insulated cables protected against earth fault currents by BS 88–2.2 fuses show that only the  $120\text{ mm}^2$  and  $400\text{ mm}^2$  two-core cable are likely to have insufficient armour cross-section to meet the thermal requirements. Both of these cables fail to meet the requirements when protected by the largest fuse that meets the  $I_t \geq I_n$  requirement and the fault loop impedance leads to a disconnection time of 5 s. For a fault current that would lead to a disconnection time of 0.4 s both of these cables meet the thermal requirements.

Unfortunately, the very popular two-core and three-core ‘flat’  $70^\circ\text{C}$  thermoplastic insulated and sheathed cables, having live conductors up to and including  $16\text{ mm}^2$  cross-sectional area, have protective conductors of reduced cross-sectional area which do **not** comply with Table 54.7. When such cables are used the designer must **always** check the circuit design against the adiabatic equation.

## Calculations when the protective device is a fuse

### Example 4.2

A 230 V single-phase circuit is run in two-core  $70^\circ\text{C}$  thermoplastic insulated and sheathed cable, the cross-sectional area of the (copper) live conductors being  $16\text{ mm}^2$  and that of the protective conductor  $6\text{ mm}^2$ .

If  $l = 40\text{ m}$ ,  $t_a = 30^\circ\text{C}$ ,  $Z_E = 0.35\text{ ohm}$  and the circuit is protected against overload by an 80 A BS 88–2.2 ‘gG’ fuse, check that the circuit complies with Regulation 543.1.3.

### Answer

From Table 3.1 Column 4 (because Table 54.3 applies) it is found that  $(R_1 + R_2)/m$  is 5.08 milliohms/m.

$$R_1 + R_2 = \frac{5.08 \times 40}{1000} \text{ ohm} = 0.203 \text{ ohm}$$

$$Z_s = (0.203 + 0.35) \text{ ohm} = 0.553 \text{ ohm}$$

$$I_{ef} = \frac{230}{0.553} \text{ A} = 416 \text{ A}$$

From the time/current characteristic the disconnection time is found to be approximately 4 s.

Check if  $k^2 S^2 \geq I_{ef}^2 t$ .

$$k^2 S^2 = 115^2 \times 6^2 \text{ A}^2 \text{ s} = 476\,100 \text{ A}^2 \text{ s}$$

$$I_{ef}^2 t = 416^2 \times 4 \text{ A}^2 \text{ s} = 692\,224 \text{ A}^2 \text{ s}$$

Thus  $k^2 S^2$  is not greater than  $I_{ef}^2 t$  and therefore the circuit does not comply with Regulation 543.1.3.

### Example 4.3

A 400 V three-phase circuit is run in single-core non-armoured cables having copper conductors and 90°C thermosetting insulation, clipped direct, but bunched with cables of other circuits. The phase and neutral conductors have a cross-sectional area of 25 mm<sup>2</sup> and the protective conductor is 10 mm<sup>2</sup>.

If the circuit is protected against overload by a 63 A BS 88–2.2 ‘gG’ fuse and  $l = 40$  m, check compliance with Regulation 543.1.3 when the assumed value of  $Z_E$  is 0.25 ohm and the ambient temperature is 30°C.

### Answer

From Table 3.1 Column 6 (because Table 54.3 applies) the  $(R_1 + R_2)/m$  for the circuit is found to be 3.27 milliohms/m.

Thus:

$$R_1 + R_2 = \frac{3.27 \times 40}{1000} \text{ ohm} = 0.131 \text{ ohm}$$

$$Z_s = (0.131 + 0.25) \text{ ohm} = 0.381 \text{ ohm}$$

For a 400 V three-phase circuit  $U_o$ , the voltage to earth, is  $400/\sqrt{3}$  V, i.e. is 230 V (assuming this supply is taken from the star connected secondary windings of a transformer, the star point being earthed).

$$I_{ef} = \frac{230}{0.381} \text{ A} = 604 \text{ A}$$

From the time/current characteristic for the fuse, the disconnection time is found to be approximately 0.18 s.

Check if  $k^2 S^2 \geq I_{ef}^2 t$ .  $k$  from Table 54.3 is found to be 143.

$$k^2 S^2 = 143^2 \times 10^2 \text{ A}^2 \text{ s} = 2\,044\,900 \text{ A}^2 \text{ s}$$

$$I_{ef}^2 t = 607^2 \times 0.18 \text{ A}^2 \text{ s} = 66\,321 \text{ A}^2 \text{ s}$$

Therefore the circuit does comply with Regulation 543.1.3.

Example 4.3 illustrates the particular point that when a cable is grouped with the cables of other circuits it is associated with an overcurrent protective device having a lower nominal current than that which would be used with that cable run singly. It follows that compliance with the thermal constraints under fault conditions (and the limitation in earth fault loop impedance) is less onerous when the cable is bunched.

The option is open to the designer to take account of the conductor actual operating temperature and/or the actual ambient temperature, as considered in Chapter 3 when calculating earth fault loop impedances. If this option is taken up, it is then logical to adjust the  $k$  value accordingly.

The factor  $k$  is derived from the following formula:

$$k = \sqrt{\frac{Q_c (B + 20)}{\rho_{20}} \ln \frac{(t_f + B)}{(t_i + B)}}$$

where:

$Q_c$  = volumetric heat capacity of conductor material ( $\text{J}/^\circ\text{Cmm}^3$ )

$B$  = reciprocal of temperature coefficient of resistivity at  $0^\circ\text{C}$  for the conductor ( $^\circ\text{C}$ )

$\rho_{20}$  = electrical resistivity of conductor material at  $20^\circ\text{C}$  (ohm mm)

$t_i$  = initial temperature of conductor ( $^\circ\text{C}$ )

$t_f$  = final temperature of conductor ( $^\circ\text{C}$ )

$\ln$  =  $\log_e$ .

Values of these constants are shown in Table 4.1.

Figure 4.2 has been developed for copper conductors and various insulation materials, while Figure 4.3 is the equivalent for aluminium conductors. For each insulation material the  $k$  values are plotted against the initial temperature  $t_i$   $^\circ\text{C}$  while the final temperatures are those appropriate to the insulation material and as given in Tables 54.2, 54.3, 54.4 and 54.5.

It will be seen, somewhat unexpectedly, that each graph is a straight line and the equations give, in Table 4.2,  $k$  in terms of  $t_i$   $^\circ\text{C}$ , the initial temperature.

**Table 4.1** Values of constants

Material	B°C	$Q_c$ J/°C mm <sup>3</sup>	$\rho_{20}$ ohm mm
1	2	3	4
Copper	234.5	$3.45 \times 10^{-3}$	$17.241 \times 10^{-6}$
Aluminium	228	$2.5 \times 10^{-3}$	$28.264 \times 10^{-6}$
Lead	230	$1.45 \times 10^{-3}$	$214 \times 10^{-6}$
Steel	202	$3.8 \times 10^{-3}$	$138 \times 10^{-6}$

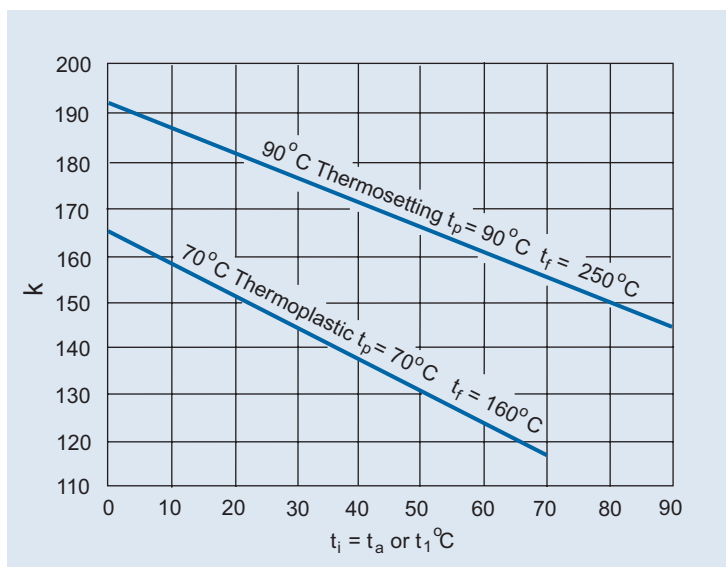
**Figure 4.2** Variation of the constant  $k$  with initial temperature – copper conductors.

Where Table 54.2 applies,  $t_i^{\circ}\text{C} = t_r$  or  $t_a^{\circ}\text{C}$  for the cpc and  $t_i^{\circ}\text{C} = t_p$  or  $t_1^{\circ}\text{C}$  for the live conductor.

Where Table 54.3 applies,  $t_i^{\circ}\text{C} = t_p$  or  $t_1^{\circ}\text{C}$  for both the cpc and live conductors.

For 70°C thermoplastic insulation the data given in the figures and in Table 4.2 apply to cross-sectional areas not exceeding 300 mm<sup>2</sup>.

It is not possible to indicate the potential advantage gained by using the design method which uses  $t_a^{\circ}\text{C}$  instead of  $t_r^{\circ}\text{C}$ ,  $t_1^{\circ}\text{C}$  instead of  $t_p^{\circ}\text{C}$  and the corresponding  $k$  values instead of those tabulated because of the interdependence of some of the factors involved.

An example now follows which gives the results from both the simple approach and the more rigorous approach, but it has to be emphasized that the comparisons made are particular to the example and should not be taken as being general.

It also shows the calculations necessary if the designer wishes to establish the minimum cross-sectional area that can be used for the circuit protective conductor.

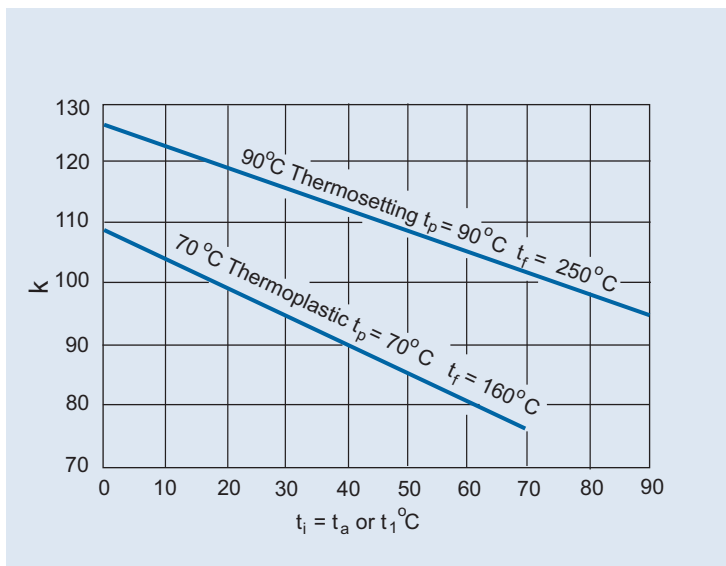

**Figure 4.3** Variation of the constant k with initial temperature – aluminium conductors.

**Table 4.2** Determination of k at different values of  $t_i^{\circ}\text{C}$

Cable insulation	For copper conductors	For aluminium conductors
<b>1</b>	<b>2</b>	<b>3</b>
70°C thermoplastic	$k = 164 - 0.7t_i$	$k = 109 - 0.47t_i$
90°C thermosetting	$k = 192 - 0.55t_i$	$k = 127 - 0.37t_i$

**Example 4.4**

A single-phase 230 V circuit is to be run in single-core 70°C thermoplastic insulated and sheathed cables having copper conductors, clipped direct, and not grouped with the cables of other circuits.

$I_b = 52\text{ A}$ ,  $t_a = 45^{\circ}\text{C}$ ,  $l = 35\text{ m}$  and  $Z_E = 0.70\text{ ohm}$

It is intended to protect the circuit against both overload and short circuit using a BS 88–2.2 ‘gG’ fuse. The disconnection time for the fuse is not to exceed 5 s.

Determine (a) the minimum nominal current for the fuse, and (b) the minimum cross-sectional area for both the live and protective conductors.

**Answer**

First, using the simple approach. As  $I_n \geq I_b$  select from the standard nominal ratings for BS 88–2.2 ‘gG’ fuses the next higher value greater than 52 A, i.e. 63 A.

From Table 4B1,  $C_a = 0.79$ .

Thus:

$$I_t = 63 \times \frac{1}{0.79} \text{ A} = 79.7 \text{ A}$$

From Table 4D1A Column 6 it is found that the minimum conductor cross-sectional area that can be used for the live conductors is 16 mm<sup>2</sup> having  $I_{ta} = 87 \text{ A}$ .

To determine the minimum protective conductor cross-sectional area may require a reiterative process. It is necessary also to check that the maximum permitted earth fault loop impedance (0.82 ohm from Table 41.4) is not exceeded and then, if necessary, that the adiabatic equation is met.

As  $Z_E = 0.70 \text{ ohm}$ ,  $(R_1 + R_2)$  under fault conditions  $\leq (0.82 - 0.70) \text{ ohm} \leq 0.12 \text{ ohm}$ . The maximum milliohms/m value that can be tolerated is therefore:

$$\frac{0.12 \times 1000}{35} \text{ milliohms/m} = 3.43 \text{ milliohms/m}$$

From Table 3.1 Column 3 a 10 mm<sup>2</sup> conductor is suitable for compliance with the limitation of earth fault loop impedance.

With the 10 mm<sup>2</sup> cpc  $(R_1 + R_2)/m = 3.28 \text{ milliohms/m}$ .

Thus:

$$R_1 + R_2 = \frac{3.28 \times 35}{1000} \text{ ohm} = 0.115 \text{ ohm}$$

$$Z_s = (0.70 + 0.115) \text{ ohm} = 0.815 \text{ ohm}$$

It remains to be checked if the 10 mm<sup>2</sup> protective conductor is adequately protected thermally, i.e. that it complies with the adiabatic equation.

$$I_{ef} = \frac{230}{0.815} \text{ A} = 282 \text{ A}$$

From the time/current characteristic given in Appendix 3 of BS 7671,  $t = 4 \text{ s}$  (approximately).

Check if  $k^2 S^2 \geq I_{ef}^2 t$ .  $k$  (from Table 54.2) is 143.

$$k^2 S^2 = 143^2 \times 10^2 \text{ A}^2 \text{ s} = 2\,044\,900 \text{ A}^2 \text{ s}$$

$$I_{ef}^2 t = 282^2 \times 4 \text{ A}^2 \text{ s} = 318\,096 \text{ A}^2 \text{ s}$$

Thus  $k^2 S^2$  is greater than  $I_{ef}^2 t$  so the protective conductor (and, of course, the phase conductor) is adequately thermally protected.

The next example illustrates the use of the more accurate approach where the circuit protective conductor is an integral part of the cable.

**Example 4.5**

A 230 V single-phase circuit is run in flat two-core cable (with cpc) 70°C thermoplastic insulated and sheathed, having copper conductors. The cable is clipped direct. The cross-sectional area of the live conductors is 16 mm<sup>2</sup> and that of the cpc is 6 mm<sup>2</sup>.  $Z_E = 0.35$  ohm and  $l = 38$  m.

If the circuit is to be protected against overload and short circuit by a 63 A BS 88–2.2 ‘gG’ fuse,  $I_b = 55$  A and  $t_a = 35^\circ\text{C}$ , check that the earth fault loop impedance does not exceed the specified maximum of 0.82 ohm and that the circuit complies with the requirements of Regulation 543.1.3.

**Answer**

The actual conductor operating temperature  $t_1$  °C is given by:

$$35 + \left( \frac{55^2}{85^2} \times 40 \right) ^\circ\text{C} = 51.7^\circ\text{C}$$

The factor 85 being the  $I_{ta}$  for the cable which is not grouped with cables of other circuits. From Table 4.2 because Table 54.3 applies:

$$k = 164 - (0.7 \times 51.7) = 128$$

From Table 3.3,  $(R_1 + R_2)/m$  at 20°C is (1.15 + 3.08) milliohms/m = 4.23 milliohms/m. From Table 3.4,  $(R_1 + R_2)$  is given by:

$$\frac{4.23 \times [0.92 + (0.004 \times 51.7)] \times 38}{1000} \text{ ohm} = 0.181 \text{ ohm}$$

Then  $Z_s = (0.35 + 0.181) \text{ ohm} = 0.531 \text{ ohm}$  and therefore is less than the specified maximum.

$$I_{ef} = \frac{230}{0.531} \text{ A} = 433 \text{ A}$$

From the time current characteristic the disconnection time is found to be approximately 0.7 s. For compliance with Regulation 543.1.3:

$$k^2 S^2 = 128^2 \times 6^2 \text{ A}^2\text{s} = 589\,824 \text{ A}^2\text{s}$$

$$I_{ef}^2 t = 433^2 \times 0.7 \text{ A}^2\text{s} = 131\,242 \text{ A}^2\text{s}$$

As  $k^2 S^2$  is greater than  $I_{ef}^2 t$ , Regulation 543.1.3 is met.

It has to be emphasized that in many cases there is no advantage in using other than the simple approach, as illustrated by Example 4.2.

Certainly for fuses up to and including those of 50 A nominal current rating it will be found that provided the maximum permitted earth fault loop impedances are not exceeded and not excessively reduced section protective conductors are used, compliance with Regulation 543.1.3 will be obtained.

## Calculations when an external cpc is in parallel with the armour

There may be circumstances where an external cpc is run in parallel with the armour of a multi-core cable to reduce the earth fault loop impedance to an acceptable level. Example 3.25 in Chapter 3 has shown how the fault loop impedance calculations are carried out for this arrangement. It has already been stated that, for most cases, the armour of a multicore cable will meet the requirements of Regulation 543.1.3. However if a relatively small conductor is run in parallel with the armour the division of fault current between the external cpc and the armour may lead to excessive current in the external cpc.

The results of work commissioned by ECA have shown that the current sharing between the armour and the external cpc can be calculated using the following equations.

As previously

$$I_{ef} = \frac{U_0}{Z_s}$$

The current carried by the external cpc,  $I_{cpc}$ , is given by:

$$I_{cpc} = I_f \frac{1.1 \times R_a}{(1.1 \times R_a + R_{cpc})}$$

The current carried by the armour,  $I_a$ , is given by:

$$I_a = I_f \frac{\sqrt{R_{cpc}^2 + 0.2^2}}{\sqrt{(1.1 \times R_a + R_{cpc})^2 + 0.2^2}}$$

### Example 4.6

This example is an extension of Example 3.25. A single-phase circuit is run in 50 mm<sup>2</sup> two-core armoured 90 °C thermosetting insulated cable having copper conductors. The protection against indirect contact is provided by the overcurrent protective device which is a 160 A BS 88–2.2 ‘gG’ fuse.

In Example 3.25 it has been shown that for  $l = 45$  m,  $R_E = 0.08$  ohm and  $X_E = 0.13$  ohm, a 4 mm<sup>2</sup> external cpc is required to achieve an earth fault loop impedance of less than 0.25 ohm. In that example a 16 mm<sup>2</sup> external cpc was selected to meet the recommendation that the external cpc should not be less than one quarter of the cross-sectional area of the line conductors. Check whether the 4 mm<sup>2</sup> external cpc meets the requirements of Regulation 543.1.3.

### Answer

The temperature of an external cpc run adjacent to a cable having 90 °C thermosetting insulation can be taken to be 70 °C.

From Tables 3.3 and 3.4:

$$R_{cpc} = 4.61 \times (0.92 + 0.004 \times 70) = 5.53$$

From Table 3.13  $R_a = 2.3$  milliohm/m

$$R_p = \frac{1}{\frac{1}{1.1 \times 2.3} + \frac{1}{5.53}} \times \frac{45}{1000} = 0.078 \text{ ohm}$$

From Example 3.25  $X_1 = 0.018$  ohm hence:

$$Z_s = \sqrt{(0.08 + 0.022 + 0.078)^2 + (0.13 + 0.018)^2} \text{ ohm}$$

$$= 0.233 \text{ ohm}$$

$$I_{ef} = \frac{230}{0.233} = 987 \text{ A}$$

From the time/current characteristics for the fuse, the disconnection time is found to be approximately 3.5 s.

$$I_{cpc} = 987 \times \frac{1.1 \times 2.3}{1.1 \times 2.3 + 5.53} = 310 \text{ A}$$

Check if  $k^2 S^2 \geq I^2 t$ . From Table 54.3,  $k = 143$ .

$$k^2 S^2 = 143^2 \times 4^2 \text{ A}^2 \text{s} = 327\,184 \text{ A}^2 \text{s}$$

$$I_{cpc}^2 t = 310^2 \times 3.5 = 336\,350 \text{ A}^2 \text{s}$$

Therefore the circuit with a 4 mm<sup>2</sup> external cpc does not comply with regulation 543.1.3.

Using the quarter size recommendation the external cpc is 16 mm<sup>2</sup>, check that this complies with regulation 543.1.3.

$$R_{cpc} = 1.15 \times (0.92 + 0.004 \times 70) = 1.38$$

$$R_p = \frac{1}{\frac{1}{1.1 \times 2.3} + \frac{1}{1.38}} \times \frac{45}{1000} = 0.040 \text{ ohm}$$

$$Z_s = \sqrt{(0.08 + 0.022 + 0.04)^2 + (0.13 + 0.018)^2} \text{ ohm}$$

$$= 0.205 \text{ ohm}$$

$$I_{ef} = \frac{230}{0.205} = 1122 \text{ A}$$

From the time/current characteristics for the fuse the disconnection time is found to be approximately 2.5 s.

$$I_{\text{cpc}} = 1122 \times \frac{1.1 \times 2.3}{1.1 \times 2.3 + 1.38} = 726 \text{ A}$$

Check if  $k^2S^2 \geq I^2t$ . From Table 54.3  $k = 143$ .

$$k^2S^2 = 143^2 \times 16^2 \text{ A}^2\text{s} = 5234944 \text{ A}^2\text{s}$$

$$I_{\text{cpc}}^2 t = 726^2 \times 2.5 = 1317690 \text{ A}^2\text{s}$$

Therefore the circuit with a 16 mm<sup>2</sup> external cpc complies with regulation 543.1.3.

## Calculations when the protective device is an mcb

When protection against indirect contact is provided by an mcb (or a circuit breaker having a similar time/current characteristic) the design approach has to be different.

As indicated in Figure 4.4 the first requirement is that the earth fault loop impedance at the remote end of the circuit being protected (or at the midpoint in the case of a ring circuit) has to be such that the disconnection time does not exceed 0.1 s (the specified so-called instantaneous time).

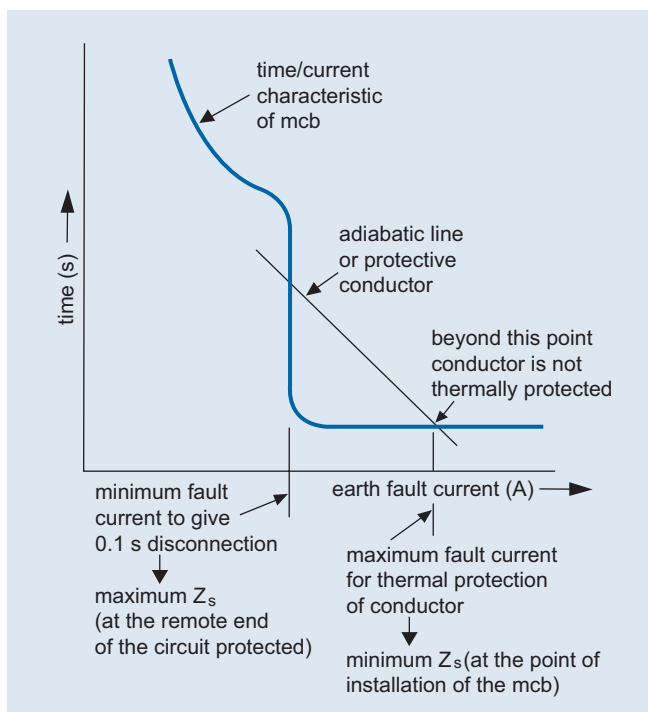

**Figure 4.4** Relationship between mcb time/current characteristic, conductor adiabatic line, and minimum and maximum values for earth fault current and earth fault loop impedance.

As indicated in Example 3.20, BS 7671 allows the designer to adopt a different value of maximum permitted earth fault loop impedance for 0.4 s disconnection compared with that for 5 s where the characteristic of the circuit breaker is such that this differentiation can be made. For the purposes of this analysis, however, the assumption is made that the designer is content to use the values given in Table 41.3 for the so-called instantaneous disconnection time of 0.1 s.

As the position of the fault approaches the mcb the earth fault loop impedance decreases so the fault current increases and the disconnection time will probably be the definite minimum time which, for mcbs to BS EN 60898 is approximately 0.01 s. Thus if the earth fault loop impedance **at the point of installation of the mcb** is less than that shown in Figure 4.4 the circuit protective conductor will no longer be thermally protected, i.e. beyond the point of intersection of the time/current characteristic and the adiabatic line. The current corresponding to this point of intersection is determined by the impedances of the source and of the circuit upstream of the mcb. Thus when an mcb is used, there is both a maximum value of  $Z_s$  for the circuit and a minimum value of  $Z_s$  at the point of installation of the mcb.

The maximum value of  $Z_s$  that can be tolerated is given by:

$$\frac{U_o}{aI_n} \text{ ohm}$$

where 'a' is the multiple of the nominal current ( $I_n$ ) of the mcb to give 0.1 s disconnection.

For Type B mcbs	$a = 5$
For Type C mcbs	$a = 10$
For Type D mcbs	$a = 20$ .

Assuming that the definite minimum time is 0.01 s, the minimum value of  $Z_s$  **at the mcb** is given by:

$$\frac{0.10 U_o}{kS} \text{ ohm}$$

For copper conductors of 1 mm<sup>2</sup> cross-sectional area and when  $U_o = 230$  V. Table 4.3 gives the values of this minimum  $Z_s$ .

As the cross-sectional area of the circuit protective conductor increases these values **decrease** in the same proportion and it is seen immediately that there should be no difficulty in meeting this requirement for installations connected to the low voltage public supply network, bearing in mind the values of  $Z_E$  that occur. In other words, it is extremely unlikely that the prospective earth fault current will be greater than that corresponding to the point of intersection of the time/current characteristic and the adiabatic line.

Many present-day mcbs are of the current limiting type and, as shown in Chapter 5 when dealing with short circuit conditions, even if the calculated fault current lies beyond the point of intersection of the adiabatic line and the time/current characteristic, comparison of the  $k^2S^2$  value for the conductor with the energy let-through ( $I^2t$ ) of the mcb will often show that the conductors **are** thermally protected.

When a circuit is protected by an mcb and that circuit is run in the standard flat two-core or three-core 70°C thermoplastic insulated and sheathed cables there is no difficulty in complying with

**Table 4.3** Minimum values of  $Z_s$  at the mcb

	70°C thermoplastic	90°C thermosetting
<b>1</b>	<b>2</b>	<b>3</b>
When Table 54.2 applies	0.161 ohm	0.131 ohm
When Table 54.3 applies	0.200 ohm	0.161 ohm

the thermal requirements of BS 7671 for the cpc. In fact, it will be found in many cases that a much reduced cpc cross-sectional area can be used, the limiting factor in design being the need to keep within the earth fault loop maxima specified in BS 7671.

Similarly when armouring or conduit or the like is used as the cpc, there should be no problem in complying with the thermal requirements under earth fault conditions.

### Example 4.7

A 230 V single-phase circuit is run in 6 mm<sup>2</sup> two-core (with cpc) 70°C thermoplastic insulated and sheathed cables having copper conductors (the cross-sectional area of the cpc is 2.5 mm<sup>2</sup>). The circuit is protected by a 40 A mcb (Type B) and  $l = 35$  m. It is assumed that  $Z_E = 0.35$  ohm.

Check that the circuit complies with Table 41.3 and that the protective conductor satisfies the adiabatic equation of Regulation 543.1.3.

### Answer

Table 54.3 applies,  $k = 115$ . From Table 3.1 Column 4,  $(R_1 + R_2)/m$  is found to be 12.6 milliohms/m.

$$R_1 + R_2 = \frac{12.6 \times 35}{1000} \text{ ohm} = 0.44 \text{ ohm}$$

$$Z_s = (0.35 + 0.44) \text{ ohm} = 0.79 \text{ ohm}$$

Table 41.3 indicates that the maximum permitted value of  $Z_s$  is 1.15 ohm.

The circuit therefore complies with Table 41.3.

The earth fault loop impedance at the mcb must not be less than:

$$\frac{0.10 \times 230}{115 \times 2.5} \text{ ohm} = 0.08 \text{ ohm}$$

This requirement is met because  $Z_E$  alone is greater. It remains to check compliance with the adiabatic equation.

The earth fault current  $I_{ef}$  is given by:

$$I_{ef} = \frac{230}{0.79} \text{ A} = 291 \text{ A}$$

It is necessary to obtain the time/current characteristic from the mcb manufacturer although because the designer knows that the disconnection time is less than 0.1 s he can either use the manufacturer's value or that from the time/current characteristics in Appendix 3 of BS 7671, from which it would appear the time is approximately 0.016 s.

$$k^2S^2 = 115^2 \times 2.5^2 \text{ A}^2\text{s} = 82\,656 \text{ A}^2\text{s}$$

$$I_{\text{ef}}^2 t = 291^2 \times 0.016 \text{ A}^2\text{s} = 1355 \text{ A}^2\text{s}$$

As  $k^2S^2$  is greater than  $I_{\text{ef}}^2 t$  the circuit complies with the adiabatic equation.

### Example 4.8

A 400 V three-phase circuit ( $U_o = 230 \text{ V}$ ) is run in single-core non-armoured 90°C thermosetting insulated cables having copper conductors, the cross-sectional area of the live conductors being 16 mm<sup>2</sup>. The cable is installed in conduit with cables of other circuits and is protected against overload and short circuit by a TP & N 32 A Type B mcb.

If  $t_a = 30^\circ\text{C}$  and  $l = 48 \text{ m}$ , determine the minimum cross-sectional area for the protective conductor for compliance with Table 41.3 and compliance with the adiabatic equation of Regulation 543.1.3.  $Z_E = 0.35 \text{ ohm}$ .

### Answer

Table 54.3 applies as the circuit is grouped with other circuits,  $k = 143$ . From Table 41.3,  $Z_s \leq 1.44 \text{ ohm}$ .

Thus the maximum tolerable value of  $(R_1 + R_2)$  is given by:

$$(1.44 - 0.35) \text{ ohm} = 1.09 \text{ ohm}$$

and the maximum tolerable value of  $(R_1 + R_2)$  in milliohms/m is:

$$\frac{1.09 \times 1000}{48} \text{ milliohms/m} = 22.71 \text{ milliohms/m}$$

As the value for 16 mm<sup>2</sup> cross-sectional area conductors is 1.47 milliohms/m (from Table 3.1 Column 6) the maximum value for the protective conductor is:

$$(22.71 - 1.47) \text{ milliohms/m} = 21.2 \text{ milliohms/m}$$

Inspection of Table 3.1 Column 5 shows that for compliance with Table 41.3 the minimum cross-sectional area for the protective conductor is 1.5 mm<sup>2</sup> having a value of 15.5 milliohms/m.

Thus:

$$(R_1 + R_2) = \frac{(1.47 + 15.5) \times 48}{1000} \text{ ohm} = 0.81 \text{ ohm}$$

$$Z_s = (0.35 + 0.81) \text{ ohm} = 1.16 \text{ ohm}$$

The circuit complies with Table 41.3.

The earth fault loop impedance at the mcb shall not be less than:

$$\frac{0.10 \times 230}{143 \times 1.5} \text{ ohm} = 0.107 \text{ ohm}$$

This requirement is met because  $Z_E$  alone is greater. It remains to check if the adiabatic equation is met.

The earth fault current  $I_{ef}$  is given by:

$$I_{ef} = \frac{230}{1.16} \text{ A} = 198 \text{ A}$$

From the time/current characteristics in Appendix 3 the disconnection time is found to be approximately 0.02 s.

$$k^2 S^2 = 143^2 \times 1.5^2 \text{ A}^2 \text{ s} = 46\,010 \text{ A}^2 \text{ s}$$

$$I_{ef}^2 t = 198^2 \times 0.02 \text{ A}^2 \text{ s} = 784 \text{ A}^2 \text{ s}$$

The circuit therefore meets the adiabatic equation.

Close to the mcbs the earth fault current will approach:

$$\frac{U_o}{Z_E} \text{ A} = \frac{230}{0.35} \text{ A} = 657 \text{ A}$$

The disconnection time will be 0.01 s and  $I_{ef}^2 t$  becomes:

$$657^2 \times 0.01 \text{ A}^2 \text{ s} = 4316 \text{ A}^2 \text{ s}$$

The circuit therefore is protected along its whole length. This last calculation, of course, is not needed as it has already been established that the earth fault loop impedance at the origin of the circuit is greater than the minimum required for a 1.5 mm<sup>2</sup> conductor cross-sectional area.

Note that a 1.5 mm<sup>2</sup> cpc is also found to be sufficient if the calculations are based on the method to be used when the protective device is not one of those listed in Appendix 3 of BS 7671.

The above is an example where although the live conductors are of 16 mm<sup>2</sup> cross-sectional area, it has been determined that the circuit protective conductor need have a cross-sectional area of only 1.5 mm<sup>2</sup>. Because the circuit is in an enclosure of a wiring system, namely conduit, the minimum requirement of 2.5 mm<sup>2</sup> cross-sectional area specified in Regulation 543.1.1 does not apply.

Cases will frequently occur in practice where the cross-sectional area of the circuit protective conductor can be justifiably considerably less than that of the associated live conductors and it becomes a matter of personal preference on the part of the designer as to whether or not the cross-sectional area of the circuit protective conductor is increased.

**Example 4.9**

A single-phase circuit is fed from the 110 V centre-tapped earth secondary of a transformer. It is run in single-core 70°C thermoplastic insulated cable having copper conductors, in conduit.

If this circuit is protected by 20 A Type C mcbs, the cross-sectional area of the live conductors is 4 mm<sup>2</sup>,  $l = 15$  m and the internal impedance of the transformer is 0.05 ohm, determine the minimum protective conductor cross-sectional area for compliance with Table 41.6, the adiabatic equation and that the earth fault loop impedance is not below the minimum required.

**Answer**

From Table 41.6 the maximum  $Z_s$  is 0.28 ohm

$$\text{Maximum tolerable } (R_1 + R_2) = (0.28 - 0.05) \text{ ohm} = 0.23 \text{ ohm}$$

$$\begin{aligned} \text{Maximum tolerable } (R_1 + R_2)/m &= \frac{0.23 \times 1000}{15} \text{ milliohms/m} \\ &= 15.3 \text{ milliohms/m} \end{aligned}$$

From Table 3.1 Column 4 it is found that the minimum protective conductor cross-sectional area is 2.5 mm<sup>2</sup>.

$$(R_1 + R_2) = \frac{14.4 \times 15}{1000} \text{ ohm} = 0.22 \text{ ohm}$$

$$Z_s = (0.05 + 0.22) \text{ ohm} = 0.27 \text{ ohm}$$

The circuit meets the requirements for maximum earth fault loop impedance.

The earth fault current  $I_{ef}$  is given by:

$$I_{ef} = \frac{55}{0.27} \text{ A} = 204 \text{ A}$$

From the time/current characteristic, the disconnection time is approximately 0.1 s. As  $k = 143$ :

$$k^2 S^2 = 143^2 \times 2.5^2 \text{ A}^2 \text{ s} = 127\,806 \text{ A}^2 \text{ s}$$

$$I_{ef}^2 t = 204^2 \times 0.1 \text{ A}^2 \text{ s} = 4162 \text{ A}^2 \text{ s}$$

As expected the circuit complies with the adiabatic equation. Finally check that at the origin of the circuit  $Z_s$  is not less than:

$$\frac{0.10 U_o}{kS} \text{ ohm}$$

i.e. is not less than

$$\frac{0.10 \times 55}{143 \times 2.5} \text{ ohm} = 0.015 \text{ ohm}$$

As the internal impedance of the transformer is 0.05 ohm this requirement is also met.

This example shows that the previous remarks based on circuits having  $U_o = 230 \text{ V}$  are equally applicable to circuits with other values of  $U_o$ . In this example the need to use a  $2.5 \text{ mm}^2$  protective conductor has been dictated by the maximum value of  $Z_s$  that can be tolerated.

Some manufacturers of mcbs in their time/current characteristics do not show the definite minimum time but instead provide  $I^2t$  characteristics. Where these are available the method previously described still applies, namely that the earth fault loop impedance at the remote end of the circuit is sufficiently low to give disconnection within 0.1 s and having determined the prospective earth fault current at the origin of the circuit the total let-through energy is obtained for that current and must be less than  $k^2S^2$ .

For instance, from one manufacturer's data, even if the earth fault loop impedance at the origin of the circuit is as low as 0.12 ohm, a  $1 \text{ mm}^2$  protective conductor would be adequately protected thermally by an mcb of any current rating up to 50 A.

Thus, as previously stated, the minimum cross-sectional area of the protective conductor will be frequently determined by the need not to exceed the maximum specified earth fault loop impedance for 0.1 s disconnection.

All the examples so far in this chapter have concerned protection against indirect contact using overcurrent protective devices.

## Calculations when the protective device is an RCD or RCBO

The remaining examples concern residual current devices (RCDs).

Where the installation is part of a TN system, the basic requirement is given in Regulation 411.4.5, i.e.:

$$Z_s \times I_a \leq U_0 \text{ volts}$$

For an RCD  $I_a$  is the rated residual operating current providing disconnection in the required time.

For TT systems the additional requirement that  $R_A \times I_{\Delta n} \leq 50 \text{ V}$  is given in Regulation 411.5.3. In this requirement  $R_A$  is the sum of the earth electrode resistance and the resistance of the protective conductor connecting it to the exposed conductive parts.

In the above expression, of course,  $I_{\Delta n}$  is in amperes. Limiting consideration to residual current circuit breakers (rccb) to BS EN 61008, the values of  $Z_s$  and  $I_{\Delta n}$  encountered in practice are such that there is no difficulty in meeting the requirement given above.

The earth fault current is limited by the value of  $Z_s$  and will be of the same order as occurs when fault protection (previously termed protection against indirect contact) is provided by overcurrent protective devices. It should be checked that the RCD complies with Regulation 531.2.8 which requires that it is capable of withstanding without damage the thermal and mechanical stresses caused by the earth fault current.

If an rccb to BS EN 61008 does not incorporate an intentional time delay it is required by the British Standard to operate within 0.04 s at a residual current of  $5I_{\Delta n}$  A and the designer merely has to check that the circuit is thermally protected for that time.

### Example 4.10

A 230 V single-phase circuit is run in two-core (with cpc) 70°C thermoplastic insulated and sheathed cable having copper conductors of 2.5 mm<sup>2</sup> cross-sectional area for the live conductors and 1.5 mm<sup>2</sup> for the protective conductor.

If  $l = 55$  m,  $Z_E = 0.8$  ohm and the circuit is protected by a 30 mA RCD check compliance with the adiabatic equation of Regulation 543.1.3.

### Answer

Table 54.3 applies. From Table 3.1:

$$(R_1 + R_2)/m = 23.4 \text{ milliohms/m}$$

$$R_1 + R_2 = \frac{23.4 \times 55}{1000} \text{ ohm} = 1.29 \text{ ohm}$$

$$Z_s = (1.29 + 0.8) \text{ ohm} = 2.09 \text{ ohm}$$

The earth fault current  $I_{ef}$  is given by:

$$I_{ef} = \frac{230}{2.09} \text{ A} = 110 \text{ A}$$

This is considerably in excess of  $5I_{\Delta n}$  so the rccb will operate within 0.04 s.  $k = 115$ :

$$k^2 S^2 = 115^2 \times 1.5^2 \text{ A}^2 \text{ s} = 29\,756 \text{ A}^2$$

$$I_{ef}^2 t = 110^2 \times 0.04 \text{ A}^2 \text{ s} = 484 \text{ A}^2 \text{ s}$$

The circuit therefore complies with the adiabatic equation.

This one example is sufficient to show that even had the rated residual operating current been considerably greater than 30 mA, the operating time would still be less than 0.04 s. Furthermore, if one wished to, an intentional time delay could have been introduced and compliance with the adiabatic equation would still have been maintained. The maximum time would have been given by

$$\frac{29\,756}{110^2} \text{ s} = 2.46 \text{ s}$$

This example suggests that if a circuit is run in single-core cables the circuit protective conductor can have a cross-sectional area considerably less than that of the associated live conductors.

### Example 4.11

A 400 V ( $U_o = 230\text{V}$ ) three-phase circuit is run in single-core non-armoured cables having 90°C thermosetting insulation and copper conductors, in conduit with the cables of other circuits.

If the live conductors have a cross-sectional area of 16 mm<sup>2</sup>,  $l = 30\text{m}$ ,  $Z_E = 0.35\text{ohm}$  and the circuit is to be protected by a 100 mA rccb (without an intentional time delay), what is the minimum cross-sectional area that can be used for the circuit protective conductor?

### Answer

Because the cables are grouped with cables of other circuits Table 54.3 applies and  $k = 143$ . Try 2.5 mm<sup>2</sup>.

From Table 3.1 Column 6:

$$(R_1 + R_2)/m = (1.47 + 9.48)\text{milliohms/m} = 10.95\text{milliohms/m}$$

$$R_1 + R_2 = \frac{10.95 \times 30}{1000}\text{ohm} = 0.329\text{ohm}$$

$$Z_s = (0.35 + 0.329)\text{ohm} = 0.679\text{ohm}$$

The earth fault current  $I_{ef}$  is given by:

$$I_{ef} = \frac{230}{0.679}\text{A} = 339\text{A}$$

This is considerably in excess of  $5I_{\Delta n}$  so that the disconnection time will not exceed 0.04 s.

$$k^2 S^2 = 143^2 \times 2.5^2 \text{A}^2\text{s} = 127\,806 \text{A}^2\text{s}$$

$$I_{ef}^2 t = 339^2 \times 0.04 \text{A}^2\text{s} = 4597 \text{A}^2\text{s}$$

Try 1 mm<sup>2</sup> (which is the minimum cross-sectional area for the type of cable concerned).

$$(R_1 + R_2)/m = (1.47 + 23.2)\text{milliohms/m} = 24.67\text{milliohms/m}$$

$$R_1 + R_2 = \frac{24.67 \times 30}{1000}\text{ohm} = 0.74\text{ohm}$$

$$Z_s = (0.35 + 0.74)\text{ohm} = 1.09\text{ohm}$$

The earth fault current  $I_{ef}$  is given by:

$$I_{ef} = \frac{230}{1.09}\text{A} = 211\text{A}$$

The disconnection time again will not exceed 0.04 s.

$$k^2 S^2 = 143^2 \times 1^2 \text{ A}^2 \text{ s} = 20\,449 \text{ A}^2 \text{ s}$$

$$I_{\text{ef}}^2 t = 211^2 \times 0.04 \text{ A}^2 \text{ s} = 1781 \text{ A}^2 \text{ s}$$

Again, the circuit meets the adiabatic equation. It may well be that the designer would not wish to use 1 mm<sup>2</sup> cross-sectional area but the above shows that a cpc having it would nevertheless comply with all the relevant requirements. (See the comment at the end of Example 4.12.)

For circuits where  $U_o = 230 \text{ V}$  and the installation is part of a TN system there is no doubt that the RCD will operate within 0.04 s provided that no intentional time delay has been incorporated within the RCD as already stated. Because of this there is another way of determining immediately if the cross-sectional area of a circuit protective conductor is adequate.

From the adiabatic equation with  $t = 0.04 \text{ s}$ :

$$k^2 S^2 \geq I_{\text{ef}}^2 \times 0.04 \text{ A}^2 \text{ s}$$

But

$$I_{\text{ef}} = \frac{U_o}{Z_s} \text{ A}$$

So

$$k^2 S^2 \geq \frac{U_o^2}{Z_s^2} \times 0.04 \text{ A}^2 \text{ s}$$

from which:

$$Z_s \geq 0.2 \times \frac{U_o}{kS} \text{ ohm}$$

Thus, for example, if  $k = 115$ ,  $U_o = 230 \text{ V}$ , and  $S = 1 \text{ mm}^2$ :

$$Z_s \geq \frac{0.2 \times 230}{115 \times 1} \text{ ohm}$$

i.e.  $Z_s \geq 0.40 \text{ ohm}$

Particularly if the system is TN-S,  $Z_E$  alone is likely to be greater than this minimum value for  $Z_s$  and if the system is TN-C-S the value of  $Z_E$  may be 0.35 ohm which is a significant portion of this minimum.

If  $U_o$  is greater than 230 V again there is no problem in complying with the basic requirement and hence obtaining the 0.04 s operation time, but for any given values of  $k$  and  $S$  the minimum value of  $Z_s$  will be greater than for the 230 V case.

If  $U_o$  is less than 230 V there is no problem in complying with the basic requirement and the minimum value of  $Z_s$  will be less than for the 230 V case.

### Example 4.12

A 230 V single-phase circuit is run in single-core 90°C thermosetting insulated cable having copper conductors, the cross-sectional area of the live conductors being 25 mm<sup>2</sup>. It is intended to provide fault protection by a 500 mA RCD.

If  $l = 40$  m,  $Z_E = 0.8$  ohm and there is no intentional time delay, what is the minimum cross-sectional area that can be used for the circuit protective conductor? The cable is not grouped with cables of other circuits and  $t_a = 30^\circ\text{C}$ .

### Answer

To comply with the adiabatic equation:

$$Z_s \geq \frac{0.2U_o}{kS} \text{ ohm (because } t \text{ will be less than } 0.04\text{s)}$$

Try 1 mm<sup>2</sup>.

$$Z_s \geq \frac{0.2 \times 230}{176 \times 1} \text{ ohm, i.e. } Z_s \geq 0.26 \text{ ohm}$$

As  $Z_E = 0.8$  ohm then  $Z_s$  will of course exceed 0.26 ohm and the 1 mm<sup>2</sup> protective conductor would comply with the adiabatic equation provided the earth fault current was sufficiently great to give 0.04 s disconnection.

Strictly speaking the values given in Table 3.1 cannot be used because in Column 3 relating to those cases where Table 54.2 applies, as in the present example, no values are given for  $R_2/m$ .

Using Tables 3.3 and 3.4:

$$R_2/m = 18.1 [0.92 + (0.004 \times 30)] \text{ milliohms/m} = 18.8 \text{ milliohms/m}$$

$$R_1 + R_2 = \frac{(0.931 + 18.8) \times 40}{1000} \text{ ohm} = 0.79 \text{ ohm}$$

$$Z_s = (0.8 + 0.79) \text{ ohm} = 1.59 \text{ ohm}$$

Whether the designer would use a 1 mm<sup>2</sup> circuit protective conductor is a matter of choice. For mechanical robustness he may decide to use a bigger conductor. In any event, remember that there is a requirement in Regulation 543.1.1 that if a protective conductor:

- (a) is not an integral part of a cable, or
- (b) is not formed by conduit, ducting or trunking, or
- (c) is not contained in an enclosure formed by a wiring system,

the cross-sectional area shall be not less than 2.5 mm<sup>2</sup> if sheathed or otherwise provided with mechanical protection and not less than 4 mm<sup>2</sup> if mechanical protection is not provided.

Now consider the case where an intentional time delay is incorporated in the RCD being used.

### Example 4.13

A 400 V three-phase circuit ( $U_o = 230$  V) is run in single-core 90°C thermosetting insulated cables having copper conductors in trunking with the cables of other circuits.  $l = 85$  m,  $Z_E = 0.35$  ohm. The live conductors are of 16 mm<sup>2</sup> cross-sectional area. Protection is given by a 100 mA RDC incorporating a time delay such that for fault currents of 500 mA or greater the disconnection time does not exceed 4 s.

Determine the minimum cross-sectional area for the circuit protective conductor.

### Answer

Try 2.5 mm<sup>2</sup> cross-sectional area. From Table 3.1 values (remembering that Table 54.3 applies):

$$R_1 + R_2 = \frac{(1.47 + 9.48) \times 85}{1000} \text{ ohm} = 0.93 \text{ ohm}$$

$$Z_s = (0.35 + 0.93) = 1.28 \text{ ohm}$$

$$Z_s I_{\Delta n} = 1.28 \times 0.1 \text{ V} = 0.128 \text{ V}$$

The circuit complies with the basic requirement of Regulation 411.4.5 and the disconnection time will not exceed 4 s (with the incorporated time delay).

$$k = 143$$

The earth fault current  $I_{ef}$  is given by:

$$I_{ef} = \frac{230}{1.28} \text{ A} = 180 \text{ A.}$$

$$k^2 S^2 = 143^2 \times 2.5^2 \text{ A}^2 \text{ s} = 127\,806 \text{ A}^2 \text{ s}$$

$$I_{ef}^2 t = 180^2 \times 4 \text{ A}^2 \text{ s} = 129\,600 \text{ A}^2 \text{ s}$$

The circuit therefore does **not** comply with the adiabatic equation, but the values obtained suggest one need only increase the cross-sectional area of the circuit protective conductor to 4 mm<sup>2</sup>.

Again from Table 3.1:

$$R_1 + R_2 = \frac{(1.47 + 5.90) \times 85}{1000} \text{ ohm} = 0.63 \text{ ohm}$$

$$Z_s = (0.35 + 0.63) \text{ ohm} = 0.98 \text{ ohm}$$

The earth fault current  $I_{ef}$  is given by:

$$I_{ef} = \frac{230}{0.98} \text{ A} = 235 \text{ A}$$

$$k^2 S^2 = 143^2 \times 4^2 \text{ A}^2 \text{ s} = 327\,184 \text{ A}^2 \text{ s}$$

$$I_{ef}^2 t = 235^2 \times 4 \text{ A}^2 \text{ s} = 220\,900 \text{ A}^2 \text{ s}$$

This time the circuit does comply.

Because the maximum time for disconnection is known (in the present case this is 4 s) there is a method which can be adopted which immediately gives the minimum cross-sectional area for the circuit protective conductor, the assumption being made that the disconnection time **will be** 4 s.

The minimum cross-sectional area is given by:

$$\frac{U_o \times \sqrt{t} - (p \times 1)}{\frac{k}{Z_E + R_1}} \text{ mm}^2$$

where  $p = 0.0221$  for a maximum operating temperature of  $90^\circ\text{C}$ .

For the present case:

$$\begin{aligned} \text{minimum } S &= \frac{\left( \frac{230 \times \sqrt{4}}{143} \right) - (0.0221 \times 85)}{0.35 + 0.125} \text{ mm}^2 \\ &= 2.82 \text{ mm}^2 \end{aligned}$$

Hence, as before, the minimum conductor cross-sectional area that can be used is  $4 \text{ mm}^2$ . Table 4.4 gives approximate values of  $p$  for copper and aluminium conductors at  $30^\circ\text{C}$ ,  $70^\circ\text{C}$  and  $90^\circ\text{C}$ .

When the installation is part of a TT system the earth fault loop impedance will be greater than those encountered in TN systems because both the earth electrode resistance at the source of energy and that at the installation itself will be part of the earth fault loop impedance. The earth fault loop impedance can be tens or hundreds of ohms but the circuit has to comply with Regulation 411.5.3.

Compliance with this regulation again will give disconnection within 0.04 s unless the RCD has an incorporated time delay and the methods given in regard to TN systems are equally applicable to TT systems.

**Table 4.4** Approximate values of  $p$  at various temperatures

Temperature, $^\circ\text{C}$	Copper	Aluminium
30	0.0179	0.0294
70	0.0207	0.0339
90	0.0221	0.0362



# 5

## Calculations related to short circuit conditions

The term 'short circuit' is no longer used in Chapter 43 of BS 7671. The term fault current now covers both earth fault current and short circuit current. The term 'short circuit' is used in this Chapter to denote a fault between live conductors. The calculations related to short circuit conditions fall into two categories:

- (a) those which have to be undertaken to determine whether the associated protective devices have adequate breaking capacity for compliance with Regulation 434.5.1, and
- (b) those which have to be undertaken to determine whether the conductors of the circuits concerned are protected thermally for compliance with Regulation 434.5.2.

In those cases where the prospective fault currents at the origin of an installation are less than the rated breaking capacity of any of the protective devices intended to be used in the installation no further assessments of the prospective fault currents are necessary in this regard.

The calculations for item (b) are very similar to those that are undertaken in relation to earth fault conditions and it is thought to be of some benefit for the purposes of this book to deal with them first.

Before doing so it is emphasized that Regulation 435.1 is of considerable importance because it allows the designer to assume compliance with Regulation 434.5.2, provided that the overcurrent protective device for the circuit concerned is intended to give both overload and short circuit protection and has adequate breaking capacity.

The adiabatic equation of Regulation 434.5.2 is exactly the same as that of Regulation 543.1.3 but stated differently. This is because when considering short circuit conditions the aim usually is to check that the overcurrent protective device disconnects the circuit concerned with sufficient rapidity.

It will be noted that the  $k$  values given in Table 43.1 are exactly the same as those given in Table 54.3. Also the assumed initial temperatures and limiting final temperatures are the same in both tables.

As with the calculation of earth fault loop impedance different assumptions are made about the conductor temperature under fault conditions depending on whether the type of protective device to be used is listed in Appendix 3 of BS 7671 or not.

If the protective device is of a type listed in Appendix 3 of BS 7671 then the conductor temperature under fault conditions can be assumed to be its normal operating temperature.

If the protective device is not of a type listed in Appendix 3 of BS 7671 then the conductor temperature under fault conditions can be assumed to be the average of its normal operating temperature and its limiting final temperature as given in Table 43.1 of BS 7671.

In either case the designer has two options. The first option is to assume that the normal operating temperature of the conductor is its maximum permitted normal operating temperature. The second option is to use the more rigorous method using the actual conductor temperature as the normal operating temperature, in this case the  $k$  value can be adjusted accordingly.

For consistency with the previous chapters, the nominal voltage, 230 V, has been used in the following examples. If it is known that the supply voltage is likely to be closer to the upper end of the tolerance band, then it is suggested that the open circuit voltage is used in calculating the prospective short circuit current. This will be an increase of about 4% in the prospective short circuit current.

### a.c. single-phase circuits

The basic equation for determining the short circuit current  $I_{sc}$  is

$$I_{sc} = \frac{U_p}{\sqrt{(R_B + R_N + R_1 + R_n)^2 + (X_B + X_N + X_1 + X_n)^2}} \text{ A} = \frac{U_p}{Z_{pn}} \text{ A}$$

where:

$R_B$  = internal resistance of the source of energy plus the resistance of the phase conductor of the supply circuit up to the point of installation of the overcurrent protective device, ohm;

$X_B$  = internal reactance of the source of energy plus the reactance of the phase conductor of the supply circuit up to that point, ohm;

$R_N$  = resistance of the neutral conductor of the supply circuit up to that point, ohm;

$X_N$  = reactance of the neutral conductor of the supply circuit up to that point, ohm;

$Z_{pn}$  = total phase and neutral impedance;

$R_1$  = resistance of the phase conductor of the protected circuit (as in earlier chapters), ohm;

$X_1$  = reactance of the phase conductor of the protected circuit, ohm;

$R_n$  = resistance of the neutral conductor of the protected circuit, ohm;

$X_n$  = reactance of the neutral conductor of the protected circuit, ohm;

$U_p$  = nominal voltage of the circuit, volts.

The values of  $R_1$  and  $R_n$  are at the assumed temperature under fault conditions but  $X_1$  and  $X_n$  are independent of temperature.  $R_B$  and  $R_N$  are at the normal operating temperature for the type of insulation used for the supply circuit cable(s).

Note that in some cases where there is not a neutral as such, e.g. where the circuit is supplied from a centre-tapped earthed secondary,  $(R_1 + R_n)$  becomes  $2R_1$ .

In many cases, such as for installations connected directly to the low voltage public supply network,  $R_B$ ,  $X_B$ ,  $R_N$  and  $X_N$  are not known separately and only the prospective short circuit current ( $I_{psc}$ ) at the origin of the installation is known. However, this immediately gives the phase-to-neutral impedance ( $Z_{pn}$ ) at the origin:

$$Z_{pn} = \frac{U_p}{I_{psc}} \text{ ohm}$$

where  $I_{psc}$  is the prospective short circuit current.

$$Z_{pn} = \sqrt{(R_B + R_N)^2 + (X_B + X_N)^2} \text{ ohm}$$

When only  $Z_{pn}$  is known the short circuit current at the remote end of the circuit concerned is given by:

$$I_{sc} = \frac{U_p}{Z_{pn} + \sqrt{(R_1 + R_n)^2 + (X_1 + X_n)^2}} \text{ A} = \frac{U_p}{Z_{pn}} \text{ A}$$

When the cross-sectional area of the conductors is less than  $35 \text{ mm}^2$  then their reactance can be ignored and the above equation becomes:

$$I_{sc} = \frac{U_p}{Z_{pn} + R_1 + R_n} \text{ A} = \frac{U_p}{Z_{pn}} \text{ A}$$

Having determined  $I_{sc}$  it is then necessary to obtain the corresponding disconnection time ( $t$ ) from the time/current characteristic of the overcurrent protective device and to then check that this time is less than  $k^2 S^2 / I_{sc}^2$  seconds.

Table 5.1 gives the values of  $(R_1 + R_n)/m$  for copper conductors of cross-sectional area up to and including  $35 \text{ mm}^2$ , assuming that the phase conductor and neutral conductor will have the same cross-sectional area. Table 5.2, likewise, gives the values of  $(R_1 + R_n)/m$  for aluminium conductors.

**Table 5.1** Values of  $(R_1 + R_n)/m$  for copper conductors at their normal operating temperature in milliohms/metre

Conductor cross-sectional area, $\text{mm}^2$	Insulation material				
	70°C thermoplastic	60°C thermosetting	90°C thermoplastic or thermosetting	MI 70°C sheath	MI 105°C sheath
1	2	3	5	6	7
1	43.4	42.0	46.3	43.7	49.1
1.5	29.0	28.1	31.0	29.2	32.8
2.5	17.8	17.2	19.0	17.9	20.1
4	11.1	10.7	11.8	11.1	12.5
6	7.39	7.15	7.88	7.44	8.35
10	4.39	4.25	4.68	4.42	4.96
16	2.76	2.67	2.94	2.78	3.12
25	1.74	1.69	1.86	1.76	1.97
35	1.26	1.22	1.34	1.27	1.42

**Table 5.2** Values of  $(R_1 + R_n)/m$  for aluminium conductors at their normal operating temperature in milliohms/metre

Conductor cross-sectional area, mm <sup>2</sup>	Insulation material	
	70°C thermoplastic	90°C thermosetting
1	2	3
16	4.58	4.89
25	2.88	3.07
35	2.08	2.22

For other assumed temperatures  $(R_1 + R_n)/m$  can be directly obtained from the single-phase mV/A/m values given in the volt drop sections of the tables in Appendix 4 of BS 7671.

$$(R_1 + R_n)/m = \text{tabulated mV/A/m} \times \left( \frac{230 + t_g}{230 + t_p} \right) \text{ milliohms/m}$$

where  $t_g$  °C is the assumed temperature under short circuit conditions and  $t_p$  °C, as before, is the maximum permitted normal operating temperature for the type of insulation concerned.

In the first series of examples it is assumed that the overcurrent protective device has a breaking capacity greater than the prospective short circuit current at the point at which it is installed. Where HBC fuses such as those in BS 88–2.2 are used their high breaking capacity is such that this assumption is fully justified in the majority of installations and there is no need to invoke the second paragraph of Regulation 434.5.1. That paragraph allows the breaking capacity to be lower than the prospective short circuit current provided there is another protective device upstream having the necessary breaking capacity and the characteristics of the devices are coordinated so that the energy let-through of the devices can be withstood by the circuit conductors.

As shown in Figure 5.1 the calculated phase-to-neutral impedance at the remote end of the circuit has to be such that the short circuit current is greater than that corresponding to the point of intersection of the adiabatic line of the conductor and the time/current characteristic of the fuse. This short circuit current with the fault at the remote end of the circuit is the minimum that can occur. Regulation 533.3 requires that account shall be taken of the minimum short circuit current where the device provides protection against fault current only.

As the position of the short circuit approaches the origin of the circuit so the short circuit current becomes increasingly greater and reaches its maximum value at the outgoing terminals of the fuse. Its maximum value is therefore the prospective fault current at the point of installation of the fuse and is determined by the phase-to-neutral impedance of the conductors upstream.

Should the short circuit occur close to the outgoing terminal of the fuse the disconnection time might well be less than 0.1 s and it then becomes necessary to check that the  $k^2S^2$  for the conductors is greater than the let-through energy ( $I^2t$ ) of the fuse, obtained from the  $I^2t$  characteristic provided by the fuse manufacturer. Figure 5.2 shows a typical example.

Some manufacturers provide this data in tabular form. In practice, when using HBC fuses it will generally be unnecessary to carry out this latter check, but in the following examples some indication is given of the  $I^2t$  values encountered.

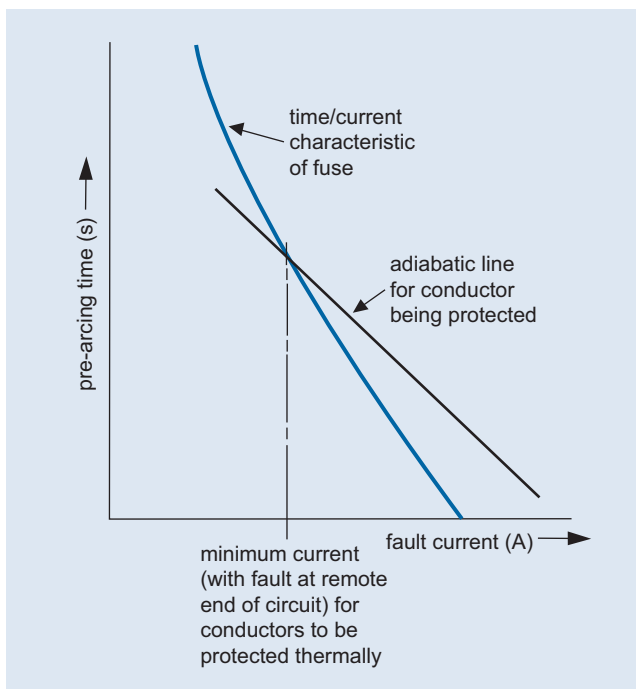

**Figure 5.1** Fuse time/current characteristic showing minimum fault current for thermal protection of conductors having the adiabatic line shown.

### Example 5.1

A 230 V single-phase circuit is run in two-core (with cpc) 70°C thermoplastic insulated and sheathed cable having copper conductors of 16 mm<sup>2</sup> cross-sectional area. It is protected only against short circuit by an 80 A BS 88–2.2 ‘gG’ fuse.

If  $l = 90$  m and the prospective short circuit current at the point of installation of the fuse is 3000 A, check that the circuit complies with Regulation 434.5.2.

### Answer

From Table 5.1 Column 2, for the circuit itself:

$$(R_1 + R_n)/m = 2.76 \text{ milliohms/m}$$

$$(R_1 + R_n) = \frac{2.76 \times 90}{1000} \text{ ohm} = 0.248 \text{ ohm}$$

$Z_{pn}$  at the point of installation of the fuse is given by

$$\frac{230}{3000} \text{ ohm} = 0.077 \text{ ohm}$$

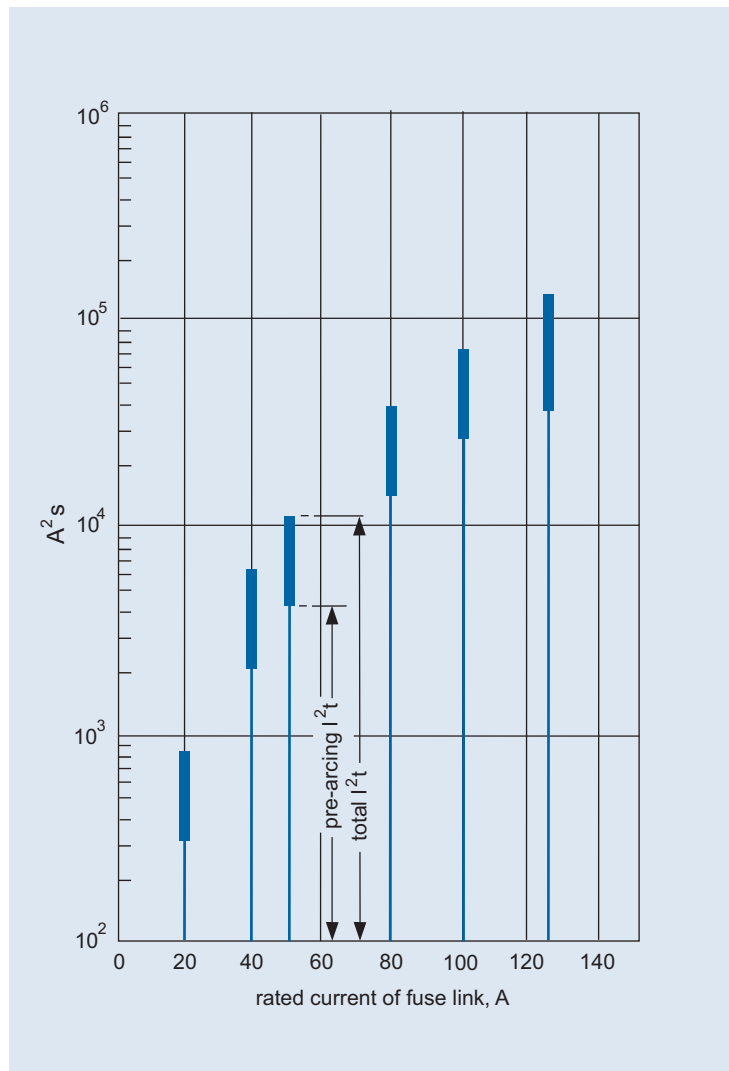

**Figure 5.2** Typical  $I^2t$  characteristics for BS 88-2.2 'gG' fuses.

$Z_{pn}$  at the remote end of the circuit is given by

$$(0.077 + 0.248) \text{ ohm} = 0.325 \text{ ohm}$$

$$I_{sc} = \frac{230}{0.325} \text{ A} = 708 \text{ A}$$

From the time/current characteristic of the fuse, as given in Appendix 3 of BS 7671, the disconnection time is 0.5 s.

From Table 43.1,  $k = 115$ .

$$k^2S^2 = 115^2 \times 16^2 \text{A}^2\text{s} = 3\,385\,600 \text{A}^2\text{s}$$

$$I_{sc}^2 t = 708^2 \times 0.5 \text{A}^2\text{s} = 250\,632 \text{A}^2\text{s}$$

Therefore Regulation 434.5.2 has been met, i.e. the circuit conductors are adequately protected against short circuit.

At the origin of the circuit, i.e. the point of installation of the overcurrent protective device, the short circuit current has been given as 3000 A. Examination of the time/current characteristic for the fuse shows that with this value of current the disconnection time is less than 0.01 s. Examination of the  $I^2t$  characteristic for the fuse indicates that its let-through energy is in the order of 30 000 A<sup>2</sup>s – far less than the calculated  $k^2S^2$  value for the conductors themselves. Thus even when the short circuit occurs close to the circuit origin the circuit conductors are adequately protected.

### Example 5.2

A single-phase circuit is fed from the 110V centre-tapped earth secondary of a transformer. The circuit is protected only against short circuit by a 63 A BS 88–2.2 ‘gG’ fuse and is run in multicore non-armoured cable having 90°C thermosetting insulation and copper conductors, clipped direct and not grouped with cables of other circuits. The live conductors are of 10 mm<sup>2</sup> cross-sectional area and  $l = 25$  m.

If the internal impedance of the transformer is 0.10 ohm, check that the circuit complies with the adiabatic equation of Regulation 434.5.2.

### Answer

From Table 5.1 Column 4, for the circuit itself:

$$(R_1 + R_n)/m = 4.68 \text{ milliohms/m}$$

$$(R_1 + R_n) = \frac{(4.68 \times 25)}{1000} \text{ ohm} = 0.117 \text{ ohm}$$

$Z_{pn}$  at the remote end of the circuit is given by:

$$(0.10 + 0.117) \text{ ohm} = 0.217 \text{ ohm:}$$

$$I_{sc} = \frac{110}{0.217} = 507 \text{ A}$$

Note that, whilst the terms  $(R_1 + R_n)$  and  $Z_{pn}$  have been used here, there is no ‘neutral’ as such.

From the time/current characteristic of the fuse, as given in Appendix 3 of BS 7671, the disconnection time is 0.4 s.

From Table 43.1,  $k = 143$ .

$$k^2 S^2 = 143^2 \times 10^2 \text{ A}^2 \text{ s} = 2\,044\,900 \text{ A}^2 \text{ s}$$

$$I_{\text{sc}}^2 t = 507^2 \times 0.4 \text{ A}^2 \text{ s} = 102\,820 \text{ A}^2 \text{ s}$$

Therefore Regulation 434.5.2 is met.

As the position of the short circuit approaches the transformer terminals the fault current approaches

$$\frac{110}{0.10} \text{ A} = 1100 \text{ A}$$

Examination of the  $I^2 t$  characteristic for the fuse would show the circuit conductors were still adequately protected thermally.

### Example 5.3

A 230 V single-phase circuit is run from a sub-distribution board at which the prospective short circuit current is 2500 A. The cables used are multicore armoured 90°C thermosetting insulated having copper conductors of 25 mm<sup>2</sup> cross-sectional area. The circuit is to be protected against short circuit by a 100 A BS 88 'gG' fuse.

If  $l = 47$  m check that the circuit complies with Regulation 434.5.2.

### Answer

From Table 5.1 Column 4, for the circuit itself:

$$(R_1 + R_n)/m = 1.86 \text{ milliohms/m}$$

$$(R_1 + R_n) = \frac{1.86 \times 47}{1000} \text{ ohm} = 0.087 \text{ ohm}$$

$Z_{\text{pn}}$  at the sub-distribution board is given by:

$$\frac{230}{2500} \text{ ohm} = 0.092 \text{ ohm}$$

$Z_{\text{pn}}$  at the remote end of the circuit is given by:

$$(0.087 + 0.092) \text{ ohm} = 0.179 \text{ ohm}$$

$$I_{\text{sc}} = \frac{230}{0.179} \text{ A} = 1285 \text{ A}$$

From the time/current characteristic of the fuse, as given in Appendix 3 of BS 7671, the disconnection time is 0.1 s.

From Table 43A,  $k = 143$ .

$$k^2 S^2 = 143^2 \times 25^2 \text{ A}^2 \text{ s} = 12\,780\,625 \text{ A}^2 \text{ s}$$

$$I_{sc}^2 t = 1285^2 \times 0.1 \text{ A}^2 \text{ s} = 165\,123 \text{ A}^2 \text{ s}$$

Therefore Regulation 434.5.2 is met.

One further example is given to show how one may use the mV/A/m values instead of resistance and reactance values.

### Example 5.4

A 230 V single-phase circuit is run in a multicore non-armoured 70°C thermoplastic insulated cable having aluminium conductors of 70 mm<sup>2</sup> cross-sectional area and  $l = 55$  m. The circuit is protected against short circuit only by an 80 A BS 88–2.2 ‘gG’ fuse. It is fed from a sub-distribution board at which the calculated  $(R_B + R_N)$  is 0.08 ohm and the calculated  $(X_B + X_N)$  is 0.17 ohm.

Check that the circuit complies with Regulation 434.5.2.

### Answer

From Table 4H2B Column 3,  $(\text{mV/A/m})_r$  is 1.05 milliohms/m and  $(\text{mV/A/m})_x$  is 0.165 milliohms/m. Thus  $(R_1 + R_n)/m$ , being numerically the same as  $(\text{mV/A/m})_r$  is 1.05 milliohms/m and  $(X_1 + X_n)/m$ , being numerically the same as  $(\text{mV/A/m})_x$  is 0.165 milliohms/m.

Thus:

$$(R_1 + R_n) \text{ for the circuit itself} = \frac{1.05 \times 55}{1000} \text{ ohm} = 0.058 \text{ ohm}$$

$$(X_1 + X_n) \text{ for the circuit itself} = \frac{0.165 \times 55}{1000} \text{ ohm} = 0.009 \text{ ohm}$$

$Z_{pn}$  at the remote end of the circuit is given by:

$$Z_{pn} = \sqrt{(0.058 + 0.08)^2 + (0.009 + 0.17)^2} \text{ ohm} = 0.226 \text{ ohm}$$

So that

$$I_{sc} = \frac{230}{0.226} \text{ A} = 1018 \text{ A}$$

From the time/current characteristic of the fuse the disconnection time is 0.1 s.  $k = 76$  (from Table 43.1).

$$k^2 S^2 = 76^2 \times 70^2 \text{ A}^2 \text{ s} = 28\,302\,400 \text{ A}^2 \text{ s}$$

$$I_{sc}^2 t = 1018^2 \times 0.1 \text{ A}^2\text{s} = 103\,632 \text{ A}^2\text{s}$$

Therefore Regulation 434.5.2 is met.

## The more rigorous method for a.c. single-phase circuits

As stated at the beginning of this chapter the second option open to the designer is to take account of the fact that the circuit conductors are probably not operating at the maximum permitted normal operating temperature for the type of insulation concerned. If this course of action is followed the conductor resistances under fault conditions will be adjusted as will be the value of  $k$ .

The method is exactly the same as the more rigorous method used for calculating earth fault loop impedances. Table 3.3 is used as the basis for the method, remembering this gives the resistance per metre for one conductor at 20°C. The relevant value has then to be multiplied by the factor appropriate to the type of cable insulation from the Table 5.3.

**Table 5.3** Adjustment factors

	Factor	
	Protective device listed in Appendix 3 of BS 7671	Protective device <i>not</i> listed in Appendix 3 of BS 7671
70°C thermoplastic	$0.92 + 0.004t_1$	$1.24 + 0.002t_1$
60°C thermosetting	$0.92 + 0.004t_1$	$1.32 + 0.002t_1$
90°C thermosetting	$0.92 + 0.004t_1$	$1.42 + 0.002t_1$

The ‘adjusted’  $k$  values are as given in Table 4.2 using the calculated operating temperature  $t_1$  instead of  $t_r$ .

### Example 5.5

A 230 V single-phase circuit is run in multicore armoured cable having 90°C thermosetting insulation and copper conductors of 16 mm<sup>2</sup> cross-sectional area, clipped direct. The circuit is protected against short circuit only by a 100 A BS 88–2.2 ‘gG’ fuse.

If  $Z_{pn}$  at the origin of the circuit is previously calculated to be 0.058 ohm,  $I_b = 80 \text{ A}$ ,  $t_a = t_r = 30^\circ\text{C}$  and  $l = 70 \text{ m}$  check compliance with Regulation 434.5.2.

### Answer

First calculate  $t_1$  °C.

From Table 4E4A Column 2,  $I_{ta} = 110 \text{ A}$ .

$$t_1 = 30 + \frac{80^2}{110^2} (90 - 30)^\circ\text{C} = 61.7^\circ\text{C}$$

From Table 3.3 and using the factor given above:

$$(R_1 + R_n) = \frac{2 \times 1.15 \times [0.92 + (0.004 \times 61.7)] \times 70}{1000} \text{ ohm} = 0.188 \text{ ohm}$$

$$Z_{pn} = (0.188 + 0.058) \text{ ohm} = 0.246 \text{ ohm}$$

Thus:

$$I_{sc} = \frac{230}{0.246} \text{ A} = 935 \text{ A}$$

From the time/current characteristic given in Appendix 3,  $t = 0.4 \text{ s}$ .

The  $k$  value from Table 4.2 is given by:

$$k = 192 \times (0.55 \times 61.7) = 158$$

Thus:

$$k^2 S^2 = 158^2 \times 16^2 \text{ A}^2 \text{ s} = 6\,390\,784 \text{ A}^2 \text{ s}$$

$$I_{sc}^2 t = 935^2 \times 0.4 \text{ A}^2 \text{ s} = 349\,690 \text{ A}^2 \text{ s}$$

The circuit therefore complies with Regulation 434.5.2.

Close to the origin of the circuit the short circuit current approaches

$$\frac{230}{0.058} \text{ A} = 3966 \text{ A}$$

Checking with the manufacturer's  $I^2 t$  characteristic would show if the circuit still complied.

### Example 5.6

A single-phase 230 V circuit is fed from a transformer having an internal resistance of 0.06 ohm and an internal reactance of 0.11 ohm. The circuit is run in single-core 90°C thermosetting insulated non-armoured cables with copper conductors of 50 mm<sup>2</sup> cross-sectional area installed on a perforated cable tray, not grouped with the cables of other circuits.

If  $t_a = 10^\circ\text{C}$ ,  $I_b = 150 \text{ A}$ ,  $l = 130 \text{ m}$  and the overcurrent protective device providing short circuit protection only is a 160 A BS 88-2.2 'gG' fuse, check that the circuit complies with Regulation 434.5.2.

### Answer

From Table 4E1A Column 8,  $I_{ta} = 242 \text{ A}$ .

$$t_1 = 10 + \frac{150^2}{242^2} (90 - 30)^\circ\text{C} = 33.1^\circ\text{C}$$

From Table 4E1B Column 4,  $(\text{mV/A/m})_r = 0.99$  milliohms/m and  $(\text{mV/A/m})_x = 0.18$  milliohms/m. So that:

$$(R_1 + R_n) = \frac{0.99}{1000} \times \left( \frac{230 + 33.1}{230 + 90} \right) \times 130 \text{ ohm} = 0.1058 \text{ ohm}$$

$$(X_1 + X_n) = \frac{0.18 \times 130}{1000} \text{ ohm} = 0.0234 \text{ ohm}$$

$$Z_{pn} = \sqrt{(0.1058 + 0.06)^2 + (0.0234 + 0.11)^2} \text{ ohm} = 0.213 \text{ ohm}$$

Thus:

$$I_{sc} = \frac{230}{0.213} \text{ A} = 1080 \text{ A}$$

From the time/current characteristic given in Appendix 3,  $t = 3$  s (approximately).

The  $k$  value from Table 4.2 is given by

$$k = 192 - (0.55 \times 33.1) = 173.8$$

$$k^2 S^2 = 173.8^2 \times 50^2 \text{ A}^2\text{s} = 75\,516\,100 \text{ A}^2\text{s}$$

$$I_{sc}^2 t = 1080^2 \times 3 \text{ A}^2\text{s} = 3\,499\,200 \text{ A}^2\text{s}$$

The circuit complies with Regulation 434.5.2.

### Example 5.7

A 230 V single-phase circuit from a sub-distribution board is run in single-core 70°C thermoplastic insulated cable in conduit. The cross-sectional area of the copper conductors is 16 mm<sup>2</sup>.  $Z_{pn}$  at the sub-distribution board has been previously calculated to be 0.09 ohm. The circuit is protected by a 63 A BS 88-2.2 'gG' fuse.

If  $Z_{pn}$  at the remote end of the circuit is calculated to be 0.22 ohm check that the circuit complies with Regulation 434.5.2.

### Answer

$$I_{sc} = \frac{230}{0.22} \text{ A} = 1045 \text{ A}$$

From the time/current characteristic in Appendix 3 of BS 7671, the disconnection time is found to be less than 0.1 s. It is therefore necessary to obtain the  $I^2t$  characteristic of the fuse from the

manufacturer. Let it be assumed it is found from this that the total  $I^2t = 11300 \text{ A}^2\text{s}$ .  $k = 115$  (from Table 43.1).

$$k^2S^2 = 115^2 \times 16^2 \text{ A}^2\text{s} = 3\,385\,600 \text{ A}^2\text{s}$$

As  $k^2S^2 > I_{sc}^2 t$  the circuit complies with Regulation 434.5.2.

Note from this example that because the disconnection time is less than 0.10 s irrespective of the position of the fault, the short circuit current at the point of installation of the fuse being 2667 A, the  $I^2t$  characteristic and not the time/current characteristic has to be consulted.

When dealing with d.c. circuits the design method is exactly the same as that just described for single-phase a.c. circuits except that one then has internal resistances of the source and, irrespective of the cross-sectional areas of the conductors under consideration, one uses their resistances only, as reactances are no longer present.

All the examples in this chapter so far have concerned fuses. When the overcurrent protective device is a circuit breaker the design approach is a little different.

Figure 5.3 shows the time/current characteristic for a circuit breaker on which is superimposed the adiabatic line for the conductor being protected. The prospective short circuit current at the origin of the circuit should not exceed  $I_{max}$  because if it did the circuit conductors would not be protected thermally over the whole length of the circuit.

Some manufacturers, in providing time/current characteristics, do not show the definite minimum time but do provide  $I^2t$  characteristics, a typical example being shown in Figure 5.4.

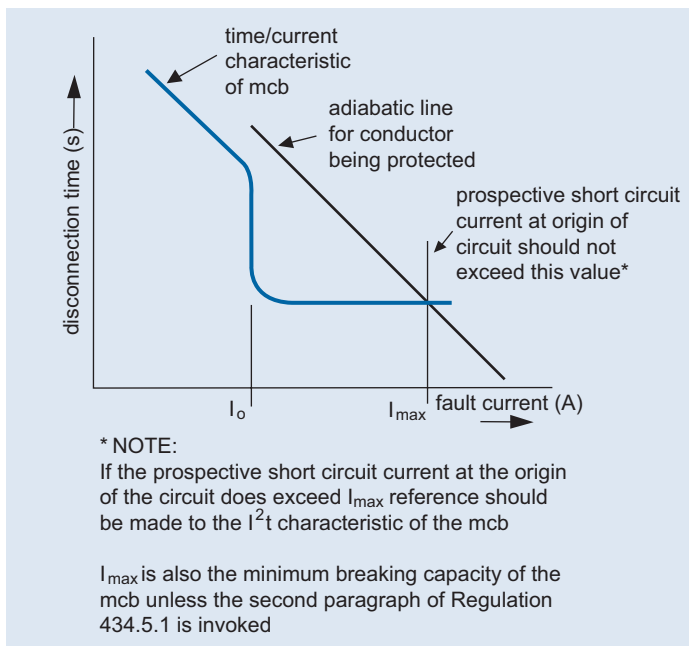

**Figure 5.3** Relationship between circuit breaker time/current characteristic and conductor adiabatic line showing maximum tolerable prospective short circuit current.

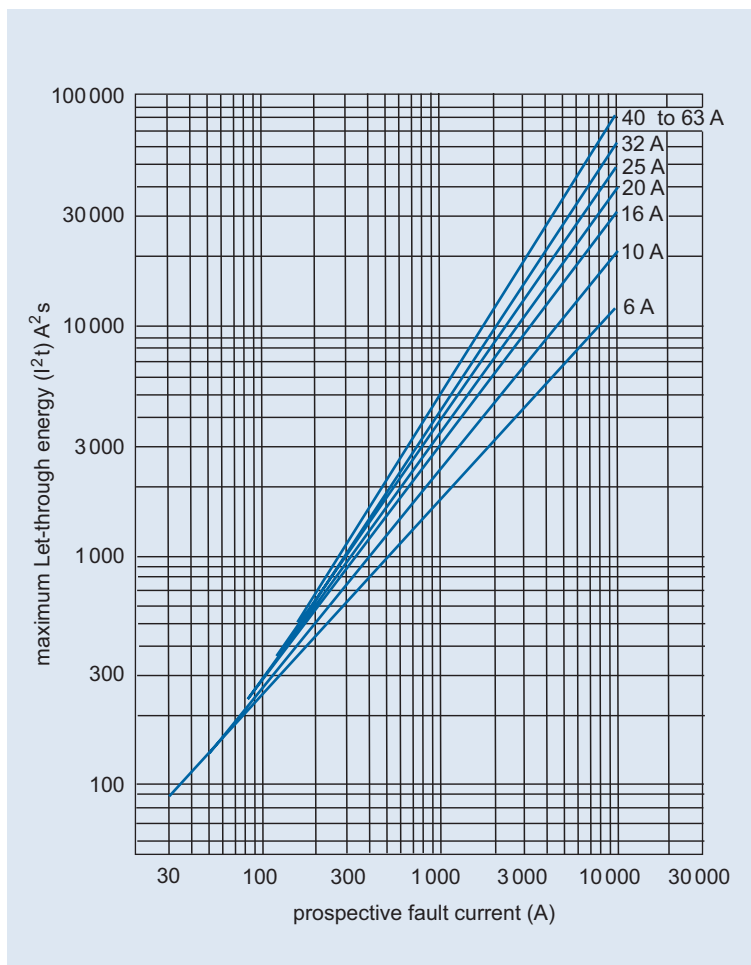

**Figure 5.4** Typical let-through energy characteristics for Type B mcb's with a breaking capacity of 10000A.

With current limiting mcb's, although  $I_{\max}$  of Figure 5.3 might be exceeded, examination of the relevant  $I^2t$  characteristic might well show that the circuit conductors are, in fact, thermally protected along the whole length of the circuit.

### Example 5.8

A 230 V single-phase circuit is run in a sheathed non-armoured cable having copper conductors and 90°C thermosetting insulation. The conductor cross-sectional area is 6 mm<sup>2</sup>. The circuit is taken from a sub-distribution board at which  $Z_{pn}$  is 0.028 ohm.

If the circuit length is 35 m and it is intended to give overload and short circuit protection by using a 40 A Type B mcb, determine the minimum breaking capacity of the mcb and check compliance with Regulation 434.5.2.

**Answer**

The short circuit current at the sub-distribution board is given by:

$$\frac{230}{0.028} \text{ A} = 8214 \text{ A}$$

The breaking capacity for the Type B mcb, selected from the standard values given in BS EN 60898, must be 10 000 A.

Despite complying with Regulation 435.1 it is worthwhile checking for compliance with Regulation 434.5.2. Because the fault current at the sub-distribution board is greater than that which will provide instantaneous operation of the mcb, according to the time/current characteristics given in Appendix 3 of BS 7671, manufacturer's  $I^2t$  data should be consulted. Typical data for a 40 A mcb indicate that the let-through energy at a prospective short circuit current of approximately 8000 A is about 60 000 A<sup>2</sup>s.

In the present case:

$$k^2S^2 = 143^2 \times 6^2 \text{ A}^2\text{s} = 736\,164 \text{ A}^2\text{s}$$

so if this particular make of mcb is used, the circuit is fully protected over its whole length and Regulation 434.5.2 is met.

**It is essential that where this approach is used the  $I^2t$  characteristic must be that from the manufacturer of the mcb it is intended to use, not those of another manufacturer.**

There is a need to check the current when the short circuit occurs at the remote end of the circuit.

From Table 5.1:

$$(R_1 + R_n)/m = 7.88 \text{ milliohms/m}$$

$$(R_1 + R_n) = \frac{7.88 \times 35}{1000} \text{ ohm} = 0.276 \text{ ohm}$$

$$I_{sc} = \frac{230}{0.028 + 0.276} \text{ A} = 757 \text{ A}$$

Again the prospective fault current is in excess of the maximum value given in Appendix 3 of BS 7671 for a 40 A Type B mcb and hence the manufacturer's let-through energy data should be consulted. However, it is clear from the previous calculation for the fault current at the sub-distribution board that the circuit is thermally protected.

Sometimes there is no need to carry out the last calculation.  $I_o$  in Figure 5.3 is also the minimum earth fault current to give protection against indirect contact and because of the impedances involved will in general be less than the short circuit current. Theoretically, however, if the installation is part of a TN-C-S system and mineral-insulated cable is used, the earth fault current will be greater than the short circuit current. It is therefore necessary to check that the latter is still sufficient to bring out the mcb within its so-called 'instantaneous' time, i.e. within 0.1 s.

### a.c. three-phase circuits

For three-phase circuits the calculations are a little more involved compared with those for single-phase circuits because there are now three types of short circuit to consider.

(a) The symmetrical three-phase short circuit current is given by:

$$I_{sc} = \frac{U_p}{\sqrt{(R_B + R_1)^2 + (X_B + X_1)^2}} \text{ A}$$

Note in particular the absence of  $R_N$ ,  $X_N$ ,  $R_n$  and  $X_n$  from the above.

(b) The short circuit current phase-to-phase is given by:

$$I_{sc} = \frac{0.87 U_p}{\sqrt{(R_B + R_1)^2 + (X_B + X_1)^2}} \text{ A}$$

Note again the absence of  $R_N$ ,  $X_N$ ,  $R_n$  and  $X_n$ .

(c) The short circuit current phase-to-neutral is given by:

$$I_{sc} = \frac{U_p}{\sqrt{(R_B + R_N + R_1 + R_n)^2 + (X_B + X_N + X_1 + X_n)^2}} \text{ A}$$

This is exactly the same as the expression for the single-phase case.

The above symbols have the same significance as before but  $R_B$  and  $X_B$  are for **one phase** of the supply and  $R_1$  and  $X_1$  are for **one of the line conductors** of the protected circuit.

$$U_p = \frac{\text{line-to-line voltage}}{\sqrt{3}} \text{ V}$$

The symmetrical three-phase fault current is always greater than the phase-to-phase short circuit current which, in turn, is always greater than the phase-to-neutral short circuit current.

Thus, as illustrated by Figure 5.5, when checking if the live conductors of a three-phase circuit are adequately protected thermally when the protective device is a fuse, i.e. that the circuit complies with the adiabatic equation, it is necessary to use the **minimum** of the three values. Thus if the neutral is not being distributed the short circuit current phase-to-phase has to be calculated and used in the adiabatic equation. If the neutral is distributed, the phase-to-phase value does not need to be calculated and compliance with the adiabatic equation is checked using the phase-to-neutral short circuit current.

When making the necessary calculations, the values of  $R_1$  and  $R_n$  are those at the assumed temperature under fault conditions taking into account, if one wishes, that the initial temperature may well be less than the maximum normal operating temperature. The values of  $R_B$  and  $R_N$  are assumed not to increase because of the fault in the final circuit and are taken to be those at the

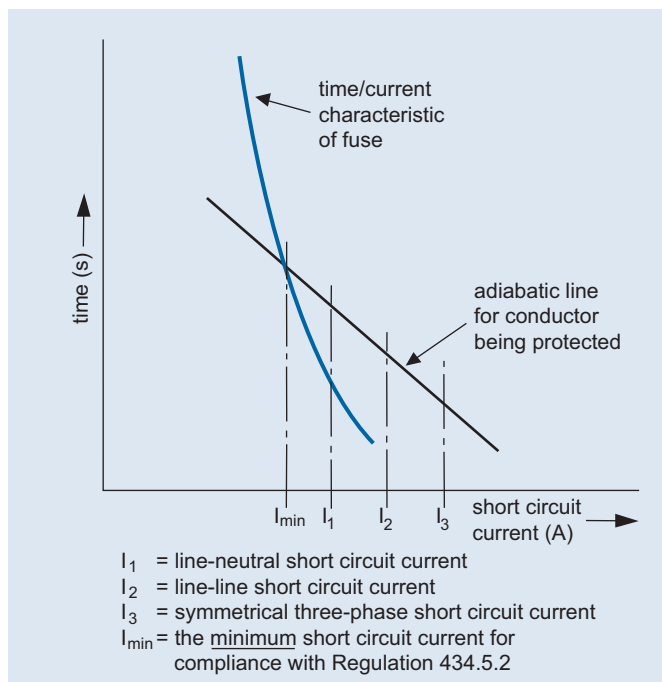

**Figure 5.5** Relationship between fuse time/current characteristic, conductor adiabetic line and three-phase short circuit currents.

maximum normal operating temperature for the cable insulation concerned, or if one wishes, at  $t_1$  °C, the actual operating temperature under normal load conditions.

In the next three examples, because short circuit protection is being provided by BS 88–2.2 ‘gG’ fuses, it is assumed that their breaking capacity is adequate and it is not necessary to invoke the second paragraph of Regulation 434–03–01.

### Example 5.9

A 400 V three-phase four-wire circuit is fed from a sub-distribution board. The previously calculated resistance of the source and distribution circuit per phase up to that board is 0.035 ohm and the reactance is 0.05 ohm. The circuit is run in a multicore armoured cable having 90°C thermosetting insulation and copper conductors of 50 mm<sup>2</sup> cross-sectional area. The cable is clipped direct,  $l = 60$  m and  $t_a = 30$ °C.

If the circuit is protected against short circuit only by a 200 A BS 88–2.2 ‘gG’ fuse, check that the circuit complies with Regulation 434.5.2.

### Answer

Because the neutral is distributed, only the phase-to-neutral short circuit current needs to be determined.

From Table 4E4B Column 4:

$$(mV/A/m)_r = 0.86 \text{ milliohms/m}; (mV/A/m)_x = 0.135 \text{ milliohms/m.}$$

Thus:

$$(R_1 + R_n) = \frac{2}{\sqrt{3}} \times \frac{0.86 \times 60}{1000} \text{ ohm} = 0.06 \text{ ohm}$$

$$(X_1 + X_n) = \frac{2}{\sqrt{3}} \times \frac{0.135 \times 60}{1000} \text{ ohm} = 0.0094 \text{ ohm}$$

The phase-to-neutral short circuit current is given by:

$$\frac{230}{\sqrt{(0.035 + 0.06)^2 + (0.05 + 0.0094)^2}} \text{ A} = 2053 \text{ A}$$

From Table 43.1,  $k = 143$ . From the time/current characteristic in Appendix 3 of BS 7671 the disconnection time is found to be 0.5 s.

$$k^2 S^2 = 143^2 \times 50^2 \text{ A}^2 \text{ s} = 51\,122\,500 \text{ A}^2 \text{ s}$$

$$I_{sc}^2 t = 2053^2 \times 0.5 \text{ A}^2 \text{ s} = 2\,107\,404 \text{ A}^2 \text{ s}$$

The circuit therefore complies with Regulation 434.5.2.

### Example 5.10

A 400 V three-phase circuit is fed from a sub-distribution board where the prospective short circuit current has already been estimated to be 14 000 A. The circuit is run in multicore armoured 90°C thermosetting insulated and sheathed cables having copper conductors of 10 mm<sup>2</sup> cross-sectional area.

If  $l = 62$  m and the circuit is protected against short circuit by 100 A BS 88–2.2 ‘gG’ fuses, check compliance with Regulation 434.5.2. The neutral is not distributed.

### Answer

Because the neutral is not distributed, the phase-to-phase short circuit current with the fault occurring at the remote end of the circuit has to be calculated.

$$Z_B = \frac{230}{14000} \text{ ohm} = 0.016 \text{ ohm}$$

From Table 5.1 Column 4:

$$R_1/m = \frac{(R_1 + R_n)/m}{2} = \frac{4.68}{2} \text{ milliohms/m} = 2.34 \text{ milliohms/m}$$

$$R_1 = \frac{2.34 \times 62}{1000} \text{ ohm} = 0.145 \text{ ohm}$$

The short circuit current phase-to-phase is given by:

$$I_{sc} = \frac{0.87 \times 230}{0.016 + 0.145} \text{ A} = 1243 \text{ A}$$

From the time/current characteristic given in Appendix 3 of BS 7671 the disconnection time is found to be approximately 0.1 s. From Table 43.1,  $k = 143$ .

$$k^2 S^2 = 143^2 \times 10^2 \text{ A}^2 \text{ s} = 2\,044\,900 \text{ A}^2 \text{ s}$$

$$I_{sc}^2 t = 1243^2 \times 0.1 \text{ A}^2 \text{ s} = 154\,505 \text{ A}^2 \text{ s}$$

The circuit therefore complies with Regulation 434.5.2.

A typical value for the energy let-through  $I^2 t$  for a 100 A fuse will be in the order of 60 000 A<sup>2</sup>s so there is no doubt that the circuit complies irrespective of the position of the fault along its length.

### Example 5.11

A 400 V three-phase circuit is fed from a distribution board where  $R_b$  has been previously calculated to be 0.02 ohm and  $X_b$  to be 0.06 ohm. The circuit is run in single-core armoured 70°C thermoplastic insulated cables having aluminium conductors of 50 mm<sup>2</sup> cross-sectional area (in trefoil touching), protected against short circuit by 160 A BS 88 'gG' fuses.

If the circuit length is 85 m and the neutral is not distributed, check for compliance with Regulation 434.5.2.

### Answer

From Table 4H3B Column 5,  $(mV/A/m)_r = 1.35$  milliohms/m and  $(mV/A/m)_x = 0.195$  milliohms/m.

As the neutral is not distributed, the phase-to-phase short circuit current with the fault at the remote end of the circuit has to be calculated.

$$R_1/m = \frac{1.35}{\sqrt{3}} \text{ milliohms/m} = 0.78 \text{ milliohms/m}$$

$$R_1 = \frac{0.78 \times 85}{1000} \text{ ohm} = 0.066 \text{ ohm}$$

$$X_1/m = \frac{0.195}{\sqrt{3}} \text{ milliohms/m} = 0.113 \text{ milliohms/m}$$

$$X_1 = \frac{0.113 \times 85}{1000} \text{ ohm} = 0.01 \text{ ohm}$$

The short circuit current phase-to-phase is given by:

$$\frac{0.87 \times 230}{\sqrt{(0.02 + 0.066)^2 + (0.06 + 0.01)^2}} \text{ A} = 1805 \text{ A}$$

From the time/current characteristic in Appendix 3 of BS 7671 the disconnection time is approximately 0.3 s.

From Table 43.1,  $k = 76$ .

$$k^2 S^2 = 76^2 \times 50^2 \text{ A}^2 \text{ s} = 14\,440\,000 \text{ A}^2 \text{ s}$$

$$I_{sc}^2 t = 1805^2 \times 0.3 \text{ A}^2 \text{ s} = 977\,407 \text{ A}^2 \text{ s}$$

The circuit therefore complies with Regulation 434.5.2.

The symmetrical three-phase currents are given:

(a) at the point of installation of the fuses by:

$$\frac{230}{\sqrt{0.02^2 + 0.06^2}} \text{ A} = 3637 \text{ A}$$

(b) at the remote end of the circuit by:

$$\frac{1805}{0.87} \text{ A} = 2075 \text{ A}$$

and it will be found the circuit still complies.

Figure 5.6 shows the time/current characteristic for an mcb on which is superimposed the adiabatic line for the conductor being protected and the various short circuit currents that occur in three-phase circuits. All the previous remarks concerning single-phase circuits protected by mcbs still apply.

As shown in Figure 5.6 the three types of short circuit current should be between  $I_o$  and  $I_{max}$ .  $I_{max}$  is again the prospective short circuit current at the origin of the circuit and is also the minimum breaking capacity for the mcb unless the second paragraph of Regulation 434.5.1 is invoked, but now  $I_{max}$  is related to the symmetrical three-phase short circuit condition.

Whilst  $I_{max}$  has been described as the current above which the circuit conductors will not be protected thermally, it must be reiterated that with current-limiting mcbs the  $I^2t$  characteristics for the device should be referred to and that, even with currents in excess of  $I_{max}$ , compliance with Regulation 434.5.2 may well be obtained.

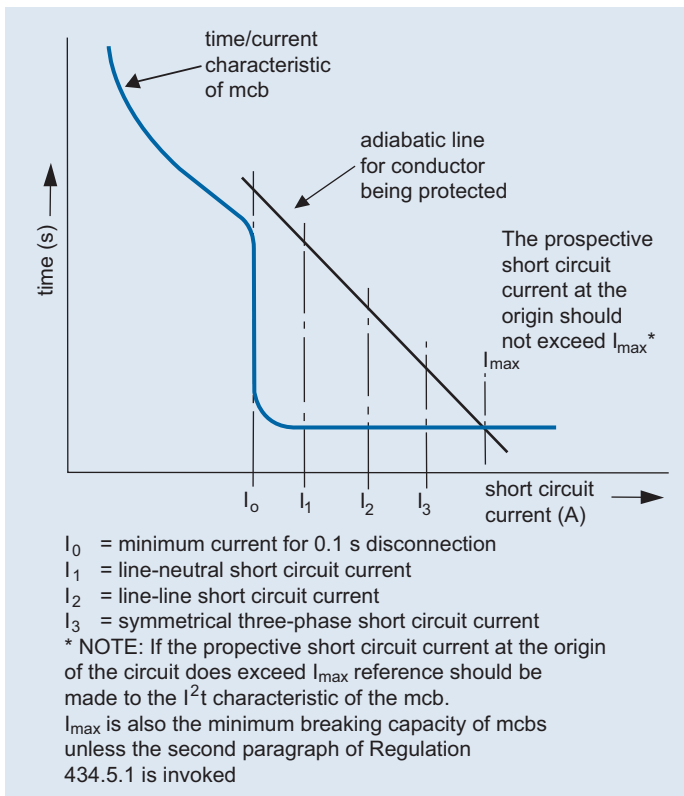

**Figure 5.6** Relationship between mcb time/current characteristic, conductor adiabatic line and three-phase short circuit currents.

**Example 5.12**

A 400 V three-phase four-wire circuit is run in a multicore 90°C thermosetting insulated and sheathed cable having copper conductors of 16 mm<sup>2</sup> cross-sectional area installed in trunking with other cables. The circuit is fed from a sub-distribution board where the previously calculated value of  $R_B$  is 0.045 ohm and of  $X_B$  is 0.02 ohm. The previously calculated value of  $R_N$  is 0.015 ohm and of  $X_N$  is 0.01 ohm.

If the length of the circuit is 90 m and it is to be protected against overload and short circuit by 50 A Type B mcbs, determine the minimum breaking capacity of the mcb and check compliance with Regulation 434.5.2.

**Answer**

The symmetrical three-phase short circuit current at the origin of the circuit is given by:

$$\frac{230}{\sqrt{0.045^2 + 0.02^2}} \text{ A} = 4671 \text{ A}$$

The breaking capacity of the mcb should be greater than 4671 A. The selection of an mcb with a breaking capacity of at least 6000 A is therefore acceptable.

Assume that from the manufacturer's  $I^2t$  characteristics the let-through energy for a 50 A mcb at the prospective short circuit current is 32 000 A<sup>2</sup>s.  $k = 143$ , so that:

$$k^2S^2 = 143^2 \times 16^2 \text{ A}^2\text{s} = 5\,234\,944 \text{ A}^2\text{s}$$

The conductors are thermally protected.

**(According to Regulation 435.1 there is no need to carry out this check.)**

As the neutral is distributed, now check that the phase-to-neutral short circuit current with the fault at the remote end of the circuit is sufficient to give disconnection in 0.1 s.

From Table 5.1 Column 4:

$$(R_1 + R_n)/m = 2.94 \text{ milliohms/m}$$

$$R_1 + R_n = \frac{2.94 \times 90}{1000} \text{ ohm} = 0.265 \text{ ohm}$$

The phase-to-neutral short circuit current is given by:

$$\frac{230}{\sqrt{(0.045 + 0.015 + 0.265)^2 + (0.02 + 0.01)^2}} \text{ A} = 705 \text{ A}$$

This prospective fault current is in excess of the maximum value given in Appendix 3 of BS 7671 for a 50 A Type B mcb and hence the manufacturer's let-through energy data should be consulted.

If the manufacturer's data indicate that the let-through energy of a 50 A mcb, for a fault current of about 750 A, is 3300 A<sup>2</sup>s, then this is less than  $k^2S^2$  for the cable, as calculated above. Thus the conductors are protected thermally for all short circuit conditions along the whole length of the circuit.

It is not the purpose of this book to make comparisons between fuses and mcbs (or mccbs), but in the present context it has to be said that one disadvantage of mcbs is that their breaking capacities are significantly less than those of HBC fuses to BS 88-2.2. Thus, cases arise when mcbs are to be installed where the prospective short circuit current is greater than their breaking capacity and it becomes necessary for the designer to invoke the second paragraph of Regulation 434.5.1. The most common example of this is the consumer unit using mcbs.

The Energy Networks Association has stated in Engineering Recommendation P25 that the maximum design value of the prospective short circuit current at the point of connection of the service cable to an Electricity Supply Company's main low voltage distribution should be taken as 16 kA. In areas other than those served by London Electricity, attenuation by the service cable can be allowed for in estimating the prospective short circuit current at the origin of the installations. Electricity companies have provided data to enable the attenuation in the service cable to be calculated.

Because many mcbs have breaking capacities less than 16 kA, it was decided to introduce in the British Standard for consumer units the concept of a conditional rating for the combination of the mcb concerned and the back-up protection afforded by the electricity company's 100 A cut-out fuse.

More generally, manufacturers are now producing data which enable the designer to correctly co-ordinate the characteristics of devices where the second paragraph of Regulation 434.5.1 has to be invoked, one example being shown in Figure 5.7.

This shows that for a 32A mcb of one particular manufacturer, which has a breaking capacity of 10000A and is in accordance with BS EN 60898, this may be installed at a point where the prospective short circuit current is greater than 10000A. This is only acceptable provided that upstream there is a BS 88–2.2 ‘gG’ fuse having a current rating of up to 160A.

Some indication of the increase of prospective short circuit current over the rated breaking capacity of moulded case circuit breakers to BS EN 60947–2 that can be tolerated where back-up protection is provided, can be obtained by first determining the cut-off current of the fuse providing that protection. This cut-off current is obtained from the manufacturer’s characteristics, an example

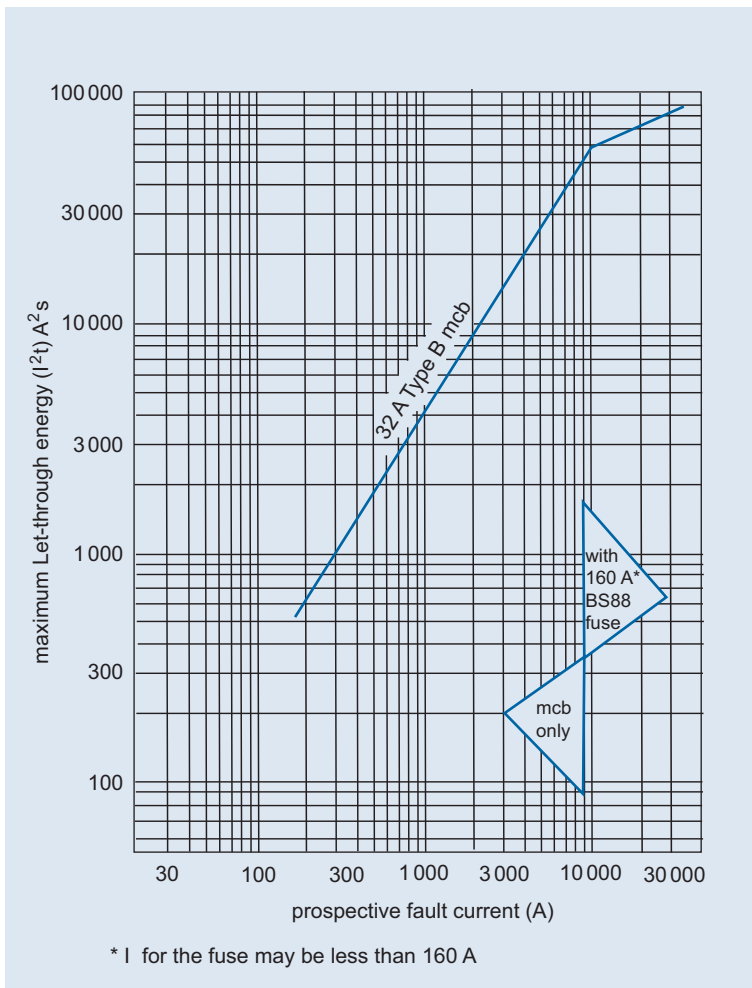

**Figure 5.7** Typical let-through energy characteristic for a Type B mcb with a breaking capacity of 10000A showing the effect of back-up protection by BS 88–2.2 ‘gG’ fuse.

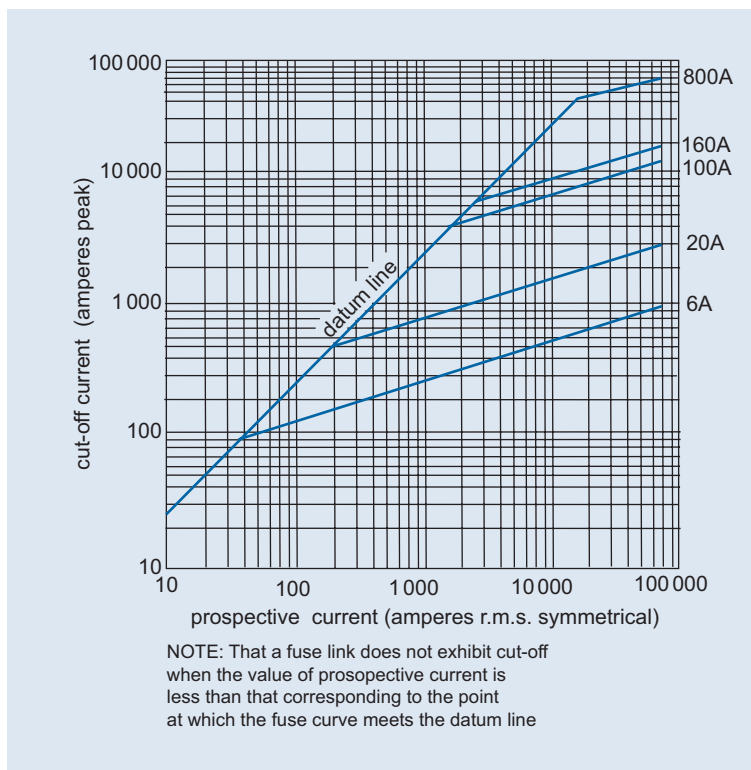

**Figure 5.8** Typical cut-off current characteristic for BS 88–2.2 ‘gG’ fuses.

being given in Figure 5.8 from which it is seen that the cut-off currents in **peak** amperes are plotted against prospective current in rms symmetrical amperes.

Having calculated the prospective short circuit current at the point of installation **of the mcb** the corresponding peak cut-off current is obtained from the cut-off characteristic of the fuse.

BS EN 600947–2 gives factors of minimum short circuit making capacity to rated short circuit breaking capacity as in Table 5.4.

**Table 5.4** Factor for minimum making capacity to rated breaking capacity

Rated breaking capacity ( $I_{cn}$ ) ka	Factor
$4.5 < I_{cs} \leq 6$	1.5
$6 < I_{cs} \leq 10$	1.7
$10 < I_{cs} \leq 20$	2.0
$20 < I_{cs} \leq 50$	2.1
$50 < I_{cs}$	2.2

For proper co-ordination to be achieved the rated breaking capacity of the mccb has to be such that when multiplied by the factor given in Table 5.4 the resulting product has to be greater than the peak cut-off current of the fuse.

A similar approach can be used for mcbs to BS EN 60898, although this standard makes no distinction between values of short circuit making capacity and short circuit breaking capacity.

### Example 5.13

A 400 V three-phase three-wire circuit is taken from a distribution board at which the prospective short circuit current (symmetrical three-phase) has been previously calculated to be 30 kA. The circuit is run in multicore armoured 90°C thermosetting-insulated cable having copper conductors of 4 mm<sup>2</sup> cross-sectional area, the cable being clipped direct and not grouped with other cables.  $l = 55$  m. The circuit is protected against overload and short circuit by a 32 A Type B mcb having a breaking capacity of 10 000 A. The circuit to the distribution board is protected by 100 A BS 88 'gG' fuses.

Check that the circuit complies with Regulation 434.5.1.

### Answer

Because the prospective short circuit current at the point of installation is greater than the breaking capacity of the mcb, data need to be obtained from the manufacturer.

Assume that information is as given in Figure 5.7. From this it is seen that the maximum total let-through energy with the stated prospective short circuit current of 30 000 A is approximately 85 000 A<sup>2</sup>s.

From Table 43.1 of BS 7671,  $k = 143$ . Thus:

$$k^2 S^2 = 143^2 \times 4^2 \text{ A}^2\text{s} = 327\,184 \text{ A}^2\text{s}$$

As this is greater than the  $I^2t$  for the mcb plus fuse, the circuit complies.

Because the neutral is not distributed, check the phase-to-phase short circuit current when the fault is at the remote end of the circuit.

From Table 5.1 Column 4:

$$(R_1 + R_n)/m = 11.8 \text{ milliohms/m}$$

so that:

$$R_1/m = 5.9 \text{ milliohms/m}$$

$$R_1 = \frac{5.9 \times 55}{1000} \text{ ohm} = 0.325 \text{ ohm}$$

Only  $Z_B$  is known and is given by:

$$Z_B = \frac{230}{30\,000} \text{ ohm} = 0.0077 \text{ ohm}$$

The phase-to-phase short circuit current with the fault occurring at the far end is given by:

$$I_{sc} = \frac{0.87 \times 230}{0.0077 + 0.325} \text{ A} = 601 \text{ A}$$

The time/current characteristics in Appendix 3 of BS 7671 indicate that, for this level of fault current, the let-through energy should be taken from the manufacturer's data. If these data are as given in Figure 5.7, then the let-through energy would be approximately 2400 A<sup>2</sup>s.

In all the examples so far there has been no need to calculate the relevant impedances from the source of energy to the origin of the circuit under consideration, because that information has been provided in some form or other.

When calculating the prospective short circuit current at the origin of a circuit this, of course, is determined by the impedances upstream of that origin. As the worst case is being calculated, those impedances should be calculated at ambient temperature values because the fault could occur in a 'cold' installation, i.e. in one which has just begun to supply load current. For this purpose the ambient temperature is taken to be 20°C (some designers use a lesser value) and not the reference ambient temperature of 30°C associated with the tables of current-carrying capacities in Appendix 4 of BS 7671.

As the cross-sectional areas of cable conductors increase it will be found that the reactance component of the impedance becomes greater than the resistance component so any advantage gained in correcting the latter to the actual operating temperature decreases. For the largest sizes,

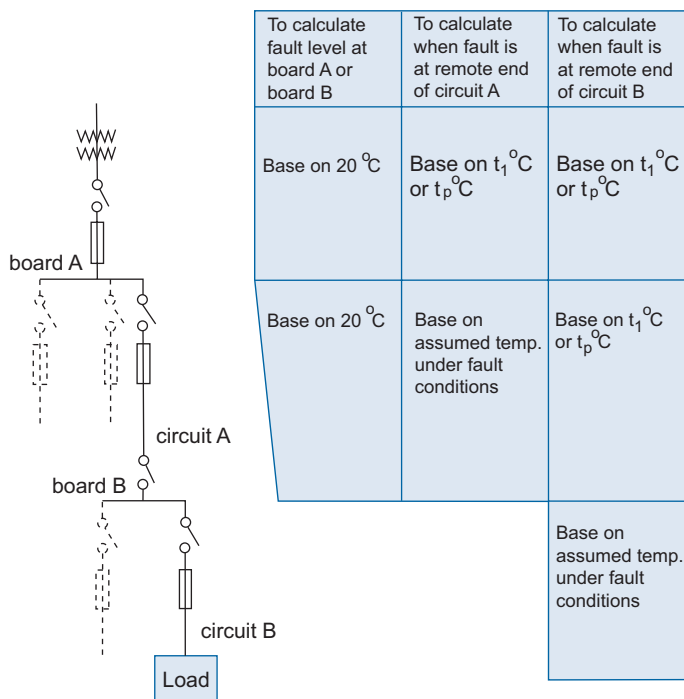

**Figure 5.9** Temperatures at which conductor resistances should be calculated.

particularly for single-core cables, the reactance component is considerably greater than the resistance component and it is quite common practice to use the former (which is independent of temperature) to calculate prospective fault currents.

When calculating the fault current at the remote end of a circuit to check that the circuit conductors are thermally protected, the impedance values for the circuit itself are those at the assumed temperature under fault conditions. Any circuit upstream of it is taken to be at the appropriate maximum normal operating temperature ( $t_p$  °C) or at the calculated actual operating temperature ( $t_1$  °C). This is shown diagrammatically in Figure 5.9 and an example is given in Chapter 6.



# 6

## Combined examples

The previous chapters have dealt with individual aspects of the design of circuits.

- Chapter 1 dealt with the calculation of conductor cross-sectional areas for compliance with Regulation 523.1: namely that under normal load conditions the maximum permitted normal operating temperature is not exceeded.
- Chapter 2 dealt with the calculation of voltage drop which in very many cases is the limiting factor in design.
- Chapter 3 dealt with the calculation of earth fault loop impedance for compliance with the requirement concerning maximum disconnection times of protective devices being used for fault protection.
- Chapter 4 dealt with the calculations concerning protective conductor cross-sectional areas for compliance with Regulation 543.1.1.
- Chapter 5 dealt with the calculations associated with short circuit conditions.

In each of these chapters a simple design method is given and, where appropriate, a more accurate or rigorous design method, together with some indication of the advantage that might be gained by the use of the latter. The purpose of this chapter, as its title indicates, is to combine all the calculations to completely design a circuit.

In undertaking the 'manual' design of any circuit one should **always** use the simple method. Only if the resulting design leads to non-compliance with the relevant requirements should consideration be given to redesigning using the more accurate or rigorous methods because these might avoid the need to increase conductor cross-sectional areas and hence the material costs.

Circumstances might arise where, in any event, it may be cheaper to increase conductor cross-sectional areas than to incur additional design costs. Each case has to be treated on its own merits and the experience of the designer should indicate the appropriate course of action to take.

Where computer programs are used there is no reason why these should not adopt some, if not all, of the more rigorous design methods.

Where it is intended to use the so-called standard circuit arrangements, such as the 32A ring circuit or the 20A radial circuit the design requirement is normally limited to ensuring that the circuit lengths are such that the resulting impedances are within the specified maxima. Only if such circuits are grouped or are operating in a high ambient temperature are any circuit calculations required. For this reason the great majority of the examples in this chapter are of 'non-standard' circuit arrangements.

Having chosen the type of cable to use and the method of installation, e.g. whether grouped or run singly and whether clipped direct or enclosed, the route the circuit concerned is intended to take is determined and the circuit route length then estimated. That estimation should be as accurate as is reasonably practicable because this determines, to some extent, the accuracy of the calculated values of the resistances and impedances of the circuit conductors. This point is an important one because the calculation of conductor resistances and impedances is a major part of the design of circuits.

Ignoring for the present the assessment of the breaking capacities of protective devices, the calculations used in designing circuits are:

- (a) those for determining the minimum conductor cross-sectional areas that can be used for compliance with Regulation 523.1 and, where appropriate, with the requirements for overload protection prescribed in Regulation 433.1.1;
- (b) those for checking compliance with the voltage drop limitation prescribed in Regulation 525;
- (c) those for determining conductor resistances or impedances in order to check compliance, where appropriate, with the requirements of Section 413 (fault protection using automatic disconnection of supply), Regulation 434.5.2 (short circuit protection) and Section 543 (protective conductors).

For item (c) the designer is faced with a particular dilemma because, as shown in Figures 3.1 and 5.9, he may have to calculate the circuit resistances and impedances at more than one temperature. Furthermore, whilst for item (b) the designer may use the tabulated mV/A/m values these are really resistance and impedance values at the maximum permitted normal operating temperature for the type of cable insulation concerned.

Having carried out all the necessary calculations the designer has to indicate to the person carrying out the tests to verify compliance with BS 7671, the values of resistance and impedance which should not be exceeded in those tests. Obviously the tester does not want to correct the values specified by the designer to the temperature at which the tests will be undertaken. The tester will expect that conversion to be done by the designer.

It is suggested that 20°C is a reasonable temperature to pick as the test temperature although, in practice, cases will arise where the actual ambient temperature may be considerably different and in such cases some account has to be taken of that fact. Even if a circuit has been designed say for a high ambient temperature, it does not necessarily follow that that will be the actual temperature during the tests for compliance.

It is therefore not possible to lay down a hard and fast rule on this matter, but for the purposes of illustration in some of the following examples the test values of conductor resistance or impedance are based on 20°C.

The first series of examples are for individual circuits where the assumption has been made that the breaking capacity of the associated protective device is adequate.

### **Example 6.1**

A 230 V single-phase circuit is to be run in flat two-core (with cpc) 70°C thermoplastic insulated and sheathed cable having copper conductors clipped direct and not grouped with the cables of other circuits. The circuit is to be protected by a BS 88–2.2 ‘gG’ fuse against overload and short circuit. This fuse is also to give protection against indirect contact with a maximum disconnection time of 5 s.

If  $I_b = 42\text{A}$ ,  $l = 27\text{m}$ ,  $t_a = 40^\circ\text{C}$  and  $Z_E = 0.8\text{ohm}$ , determine the nominal rating of the fuse and the minimum conductor cross-sectional area that can be used if the voltage drop is not to exceed 4% of the nominal voltage.

### Answer

Because  $I_n \geq I_b$  choose from the standard ratings of BS 88-2.2 'gG' fuses  $I_n = 50\text{A}$ .

From Table 4B1,  $C_a = 0.87$ .

As  $C_g = 1$  and  $C_i = 1$ :

$$I_t = 50 \times \frac{1}{0.87} \text{ A} = 57.5 \text{ A}$$

From Table 4D5A Column 6 it is found that the minimum conductor cross-sectional area that can be used is  $10\text{mm}^2$  having  $I_{ta} = 64\text{A}$ .

From Column 3 Table 4D2B the  $\text{mV/A/m} = 4.4$  milliohms/m. Hence:

$$\text{voltage drop} = \frac{4.4 \times 42 \times 27}{1000} \text{ V} = 5 \text{ V} = 2.17\% \text{ of } 230 \text{ V}$$

The circuit therefore meets the limitation in voltage drop.

The cross-sectional area of the protective conductor for this standard cable is  $4\text{mm}^2$ .

Table 54.3 applies and from Table 3.1 Column 4,  $(R_1 + R_2)/\text{m}$  is found to be  $7.73$  milliohms/m.

$$R_1 + R_2 = \frac{7.73 \times 27}{1000} \text{ ohm} = 0.21 \text{ ohm}$$

$$Z_s = (0.8 + 0.21) \text{ ohm} = 1.01 \text{ ohm}$$

The circuit therefore meets the maximum value of  $1.04\text{ohm}$  given in Table 41.4.

It remains to check whether the cpc meets the adiabatic equation given in Regulation 543.1.3.

From Table 54.3,  $k = 115$ .

The earth fault current  $I_{ef}$  is given by:

$$\frac{230}{1.01} \text{ A} = 228 \text{ A}$$

From the time/current characteristic given in Appendix 3 of BS 7671 the disconnection time is found to be approximately  $4\text{s}$ .

For compliance  $k^2S^2 \geq I^2t$ .

$$k^2S^2 = 115^2 \times 4^2 \text{ A}^2\text{s} = 211\,600 \text{ A}^2\text{s}$$

$$I_{ef}^2t = 228^2 \times 4 \text{ A}^2\text{s} = 207\,936 \text{ A}^2\text{s}$$

The adiabatic equation is therefore met.

To obtain the **test** value for  $(R_1 + R_2)$  use Table 3.3 from which it is found to be:

$$\frac{(1.83 + 4.61) \times 27}{1000} \text{ ohm} = 0.174 \text{ ohm at } 20^\circ\text{C}$$

Having assumed that the BS 88–2.2 ‘gG’ fuse has adequate breaking capacity, Regulation 435.1 applies and there is no need to check that the circuit complies with the adiabatic equation under **short circuit** conditions, because that fuse is providing overload as well as short circuit protection.

As the circuit complies with all the requirements there has been no point in using other than the simple design approach. Remembering that the mV/A/m values for single-phase circuits are numerically twice the milliohms/m values for a single conductor, however, one could have used these to determine  $(R_1 + R_2)$ .

From Column 3 of Table 4D2B, mV/A/m for  $4\text{mm}^2 = 11$  milliohms/m and mV/A/m for  $10\text{mm}^2 = 4.4$  milliohms/m. Thus:

$$(R_1 + R_2)/\text{m at } 70^\circ\text{C} = \frac{11 + 4.4}{2} \text{ milliohms/m} = 7.7 \text{ milliohms/m}$$

$$(R_1 + R_2)/\text{m at } 20^\circ\text{C} = \left( \frac{230 + 20}{230 + 70} \right) \times 7.7 \text{ milliohms/m} = 6.42 \text{ milliohms/m}$$

Using these values one would obtain:

$$(R_1 + R_2) \text{ at } 70^\circ\text{C} = 0.208 \text{ ohm}$$

$$(R_1 + R_2) \text{ at } 20^\circ\text{C} = 0.173 \text{ ohm.}$$

### Example 6.2

A 230 V single-phase circuit is to be run in single-core  $90^\circ\text{C}$  thermosetting insulated cables having copper conductors, in trunking with five other similar circuits. The circuit is to be protected by a BS 88–2.2 ‘gG’ fuse against overload and short circuit. This fuse is also to give protection against indirect contact with a maximum disconnection time of 5 s.

If  $I_b = 38\text{ A}$ ,  $l = 90\text{ m}$ ,  $t_a = 45^\circ\text{C}$ ,  $Z_E = 0.8\text{ ohm}$  and the power factor of the load is 0.8 lagging, determine the minimum live and protective conductor cross-sectional area that can be used. The voltage drop is not to exceed  $2\frac{1}{2}\%$  of the nominal voltage.

### Answer

Because  $I_n \geq I_b$  choose from the standard ratings of BS 88 Pt 2 fuses  $I_n = 40\text{ A}$ .

From Table 4C1,  $C_g = 0.57$ . From Table 4B1,  $C_a = 0.87$ .

$$I_t = 40 \times \frac{1}{0.57} \times \frac{1}{0.87} \text{ A} = 80.7 \text{ A}$$

From Table 4E1A Column 4 it is found that the minimum conductor cross-sectional area that can be used is  $16 \text{ mm}^2$  having  $I_{ta} = 100 \text{ A}$ .

Check for voltage drop.

From Column 3 of Table 4E1B  $(\text{mV/A/m}) = 2.9$  milliohms/m.

The voltage drop (using the simple approach) is given by:

$$\frac{2.9 \times 38 \times 90}{1000} \text{ V} = 9.9 \text{ V} = 4.3\% \text{ of } 230 \text{ V}$$

This is in excess of the permitted maximum voltage drop. Although consideration could be given to the effect of power factor and operating temperature, it is unlikely that these effects would be sufficient to bring the voltage drop down to 2.5%. Thus the next largest conductor size,  $25 \text{ mm}^2$ , is selected.

From Column 3 of Table 4E1B  $(\text{mV/A/m})_t = 1.85$  milliohms/m,  $(\text{mV/A/m})_x = 0.31$  milliohms/m and  $(\text{mV/A/m})_z = 1.90$  milliohms/m.

The voltage drop (using the simple approach) is given by:

$$\frac{1.9 \times 38 \times 90}{1000} \text{ V} = 6.5 \text{ V} = 2.8\% \text{ of } 230 \text{ V}$$

This is in excess of the permitted maximum voltage drop, but in this case advantage should be taken of the power factor of the load. As this is 0.8, the value of  $\sqrt{1 - \cos^2 \phi} = 0.6$ .

Thus the voltage drop is given by:

$$\frac{(0.8 \times 1.9) + (0.6 \times 0.31)}{1000} \times 38 \times 90 \text{ V} = 5.8 \text{ V} = 2.54\%$$

Again the circuit does not meet the limitation of voltage drop. The calculated voltage drop is close to the required value, however, and so the effect of operating temperature should be considered.

$$C_t = \frac{230 + 90 - \left( 0.87^2 \times 0.57^2 - \frac{38^2}{40^2} \right) (90 - 30)}{230 + 90} = 0.88$$

Now the voltage drop is given by:

$$\frac{(0.8 \times 1.9 \times 0.88) + (0.6 \times 0.31)}{1000} \times 38 \times 90 \text{ V} = 5.2 \text{ V} = 2.26\%$$

The circuit therefore does meet the limitation of voltage drop.

The next stage is to determine the minimum cross-sectional area for the circuit protective conductor.

From Table 41.4 the maximum value of  $Z_s$  that can be tolerated is 1.35 ohm.

Thus the maximum value of  $(R_1 + R_2)$  that can be tolerated is  $(1.35 - 0.8) \text{ ohm} = 0.55 \text{ ohm}$ .

The maximum value of  $(R_1 + R_2)/\text{m}$  that can be tolerated is therefore given by:

$$\frac{0.55 \times 1000}{90} \text{ milliohms/m} = 6.1 \text{ milliohms/m}$$

As Table 54.3 applies (because the circuit is grouped with other circuits), from Table 3.1 Column 6 the  $R_1/m$  for  $25 \text{ mm}^2$  is  $0.931 \text{ milliohms/m}$ .

Thus the maximum  $R_2/m$  that can be tolerated is  $5.17 \text{ milliohms/m}$  and therefore the minimum cross-sectional area for the circuit protective conductor is  $6 \text{ mm}^2$  having a value of  $3.94 \text{ milliohms/m}$ .

$$(R_1 + R_2) = \frac{(0.931 + 3.94) \times 90}{1000} \text{ ohm} = 0.44 \text{ ohm}$$

$$Z_s = (0.8 + 0.44) \text{ ohm} = 1.24 \text{ ohm}$$

The earth fault current  $I_{ef}$  is given by:

$$I_{ef} = \frac{230}{1.24} \text{ A} = 185 \text{ A}$$

From the time/current characteristic in Appendix 3 of BS 7671 the disconnection time is found to be approximately  $4 \text{ s}$ .  $k = 143$ .

$$k^2 S^2 = 143^2 \times 6^2 \text{ A}^2 \text{ s} = 736\,164 \text{ A}^2 \text{ s}$$

$$I_{ef}^2 t = 185^2 \times 4 \text{ A}^2 \text{ s} = 136\,900 \text{ A}^2 \text{ s}$$

The circuit protective conductor is therefore thermally protected.

The test value for  $(R_1 + R_2)$  at  $20^\circ\text{C}$  is found from Table 3.3 to be:

$$\frac{(0.727 + 3.08) \times 90}{1000} \text{ ohm} = 0.343 \text{ ohm}$$

In this example there has been no point in considering whether the circuits are liable to simultaneous overload or not. The ratio  $I_b/I_n$  is  $38/40 = 0.95$  and inspection of Figure 1.2 immediately shows that there is no real advantage to be gained as the reduction factor is very close to unity.

### Example 6.3

A  $230 \text{ V}$  single-phase circuit is intended to be run in single-core non-armoured cables having  $90^\circ\text{C}$  thermosetting insulation and copper conductors, in conduit but not with the cables of other circuits. The circuit is to be protected against fault current by a BS 88–2.2 ‘gG’ fuse which also is to provide fault protection, the maximum permitted disconnection time being  $5 \text{ s}$ .

If  $I_b = 28 \text{ A}$ ,  $t_a = 50^\circ\text{C}$ ,  $l = 24 \text{ m}$  and  $Z_E = 0.35 \text{ ohm}$ , what is the minimum cross-sectional area of the live and protective conductors that can be used? The short circuit current at the point of installation of the fuse has previously been calculated to be  $4000 \text{ A}$  and the voltage drop is not to exceed  $2\frac{1}{2}\%$  of the nominal voltage.

## Answer

As the fuse is not providing overload protection, the design current  $I_b$  is used to determine the minimum cross-sectional area for the live conductors.

From Table 4B1,  $C_a = 0.82$ .

Thus:

$$I_t = 28 \times \frac{1}{0.82} \text{ A} = 34 \text{ A}$$

From Table 4E1A Column 4 it is immediately seen that the minimum cross-sectional area for the live conductors appears to be  $4 \text{ mm}^2$  having  $I_{ta} = 42 \text{ A}$ .

First check the voltage drop.

From Column 3 Table 4E1B the  $\text{mV/A/m}$  is 12 milliohms/m.

The voltage drop is given by:

$$\frac{12 \times 28 \times 24}{1000} \text{ V} = 8.06 \text{ V} = 3.5\%$$

The circuit therefore does not meet the voltage drop limitation. The maximum  $\text{mV/A/m}$  value which can be tolerated is given by:

$$\frac{5750}{28 \times 24} \text{ milliohms/m} = 8.56 \text{ milliohms/m}$$

Re-inspection of Column 3 shows that it is necessary to use conductors of  $6 \text{ mm}^2$  cross-sectional area having  $\text{mV/A/m}$  of 7.9 milliohms/m and  $I_{ta} = 54 \text{ A}$ .

Now determine the minimum cross-sectional area of the circuit protective conductor. It is first necessary to determine  $I_n$  to establish the maximum earth fault loop impedance that can be tolerated. Whilst  $I_n$  must always be equal to or greater than  $I_b$ , however, as only short circuit protection is intended  $I_n$  can be **greater** than the effective current-carrying capacity of the conductor  $I_z$ .

In the present case:

$$I_z = 54 \times 0.82 \text{ A} = 44.3 \text{ A}$$

Let it be assumed that because of the characteristics of the load it is decided to use a fuse having  $I_n = 50 \text{ A}$ .

From Table 41.4 the maximum permitted  $Z_s$  is 1.04 ohm.

The maximum value of  $(R_1 + R_2)$  is therefore:

$$(1.04 - 0.35) \text{ ohm} = 0.69 \text{ ohm}$$

The maximum value of  $(R_1 + R_2)/\text{m}$  that can be tolerated is given by:

$$\frac{0.69 \times 1000}{24} \text{ milliohms/m} = 28.75 \text{ milliohms/m}$$

Table 54.3 applies, if a check is to be made to see if the protective conductors can have a cross-sectional area of  $1.5 \text{ mm}^2$ , use Table 3.1, from which:

$$R_2/m = 15.5 \text{ milliohms/m}$$

$$R_1/m = 3.94 \text{ milliohms/m}$$

Thus  $(R_1 + R_2)/m = 19.44 \text{ milliohms/m}$  and it would seem that  $1.5 \text{ mm}^2$  cross-sectional area can be used for the circuit protective conductor. Thus:

$$(R_1 + R_2) = \frac{19.44 \times 24}{1000} \text{ ohm} = 0.467 \text{ ohm}$$

$$Z_s = (0.35 + 0.467) \text{ ohm} = 0.817 \text{ ohm}$$

The earth fault current is given by:

$$\frac{230}{0.817} \text{ A} = 282 \text{ A}$$

From the time/current characteristic given in Appendix 3 of BS 7671 the disconnection time is 1.6 s.

From Table 54.3,  $k = 143$ . Thus:

$$k^2 S^2 = 143^2 \times 1.5^2 \text{ A}^2 \text{ s} = 46\,010 \text{ A}^2 \text{ s}$$

$$I_{\text{ef}}^2 t = 282^2 \times 1.6 \text{ A}^2 \text{ s} = 127\,238 \text{ A}^2 \text{ s}$$

As  $k^2 S^2 < I_{\text{ef}}^2 t$  the circuit does not meet the requirements of Regulation 543.1.3.

Try  $2.5 \text{ mm}^2$  cross-sectional area for the protective conductor.

From Table 3.1 Column 5,  $(R_1 + R_2)/m$  is found to be  $13.4 \text{ milliohms/m}$ .

Thus:

$$R_1 + R_2 = \frac{13.4 \times 24}{1000} \text{ ohm} = 0.322 \text{ ohm}$$

$$Z_s = (0.35 + 0.322) \text{ ohm} = 0.672 \text{ ohm}$$

$$I_{\text{ef}} = \frac{230}{0.672} \text{ A} = 342 \text{ A}$$

From the time/current characteristic,  $t = 0.5 \text{ s}$ . Thus:

$$k^2 S^2 = 143^2 \times 2.5^2 \text{ A}^2 \text{ s} = 131\,406 \text{ A}^2 \text{ s}$$

$$I_{cf}^2 t = 342^2 \times 0.5 \text{ A}^2\text{s} = 58482 \text{ A}^2\text{s}$$

As  $k^2 S^2 > I_{cf}^2 t$  the circuit with a cpc of  $2.5 \text{ mm}^2$  cross-sectional area meets the requirements of Regulation 543.1.3.

There remains the check that the circuit is adequately protected thermally under short-circuit conditions.

From Table 5.1 Column 4,  $(R_1 + R_n)/m$  is found to be 7.88 milliohms/m so total phase/neutral impedance is given by:

$$\frac{230}{4000} + \left( \frac{7.88 \times 24}{1000} \right) \text{ ohm} = 0.247 \text{ ohm}$$

The short circuit current is given by:

$$\frac{230}{0.247} \text{ A} = 931 \text{ A}$$

From the time/current characteristics the disconnection time is found to be less than 0.01 s and it would be necessary to obtain the  $I^2 t$  characteristic from the fuse manufacturer to check compliance with Regulation 434.5.2.

The test value for  $(R_1 + R_2)$  is obtained from Table 3.3 and is given by:

$$\frac{(3.08 + 7.41) \times 24}{1000} \text{ ohm} = 0.252 \text{ ohm}$$

In this example one step that should have been taken has been omitted. When it was found that  $4 \text{ mm}^2$  live conductors apparently failed to meet the 2½% voltage drop limitation, a recalculation taking account of the actual conductor temperature should have been made.

With the  $4 \text{ mm}^2$  cross-sectional area conductor:

$$\frac{I_b}{I_{ta}} = \frac{28}{42} = 0.67$$

From Figure 2.2 for this value of  $I_b/I_{ta}$  and  $t_a = 50^\circ\text{C}$ , the reduction factor is found to be approximately 0.955.

The more correct voltage drop would therefore have been:

$$3.5 \times 0.955\% = 3.3\%$$

Thus, in this case, taking account of the actual conductor temperature has not avoided the need to increase the cross-sectional area to  $6 \text{ mm}^2$ .

### Example 6.4

A 400 V three-phase four-wire circuit is to be taken from a sub-distribution board where the prospective short circuit current has been calculated to be 5500 A, the resistance component of

the earth fault loop impedance is 0.2 ohm and the reactance component 0.08 ohm. The circuit is to be run in multicore non-armoured 90°C thermosetting insulated cable having copper conductors, clipped direct and not grouped with the cables of other circuits. Protection against overload and short circuit is to be provided by BS 88–2.2 ‘gG’ fuses. These are also to give fault protection with a maximum disconnection time 5 s.

If  $t_a = 45^\circ\text{C}$ ,  $I_b = 41\text{ A}$  and  $l = 105\text{ m}$ , design the circuit for compliance with the relevant regulations, the maximum recommended voltage drop being 2½% of the nominal voltage.

### Answer

Select the nominal current of the fuse from the standard ratings.

$$I_n = 50\text{ A}$$

The only correction factor is that for ambient temperature.

From Table 4B1,  $C_a = 0.87$ . Thus:

$$I_t = 50 \times \frac{1}{0.87}\text{ A} = 57.5\text{ A}$$

From Table 4E2A Column 7 the minimum cross-sectional area for the live conductors is found to be 10 mm<sup>2</sup> having  $I_{ta} = 71\text{ A}$ . The cross-sectional area for the cpc is then 6 mm<sup>2</sup>.

Now check the voltage drop.

From Table 4E2B Column 4, mV/A/m = 4.0 milliohms/m.

$$\text{Voltage drop} = \frac{4.0 \times 105 \times 41}{1000}\text{ V} = 17.2\text{ V}$$

This is greater than the permitted maximum voltage drop of 10 V. If a 16 mm<sup>2</sup> conductor is selected,  $I_{ta} = 96\text{ A}$ , mV/A/m = 2.5 milliohms/m. The voltage drop is then 10.8 V. This is only marginally greater than the permitted voltage drop.

From Figure 2.2 for  $t_a = 45^\circ\text{C}$  and  $I_b/I_{ta} = 41/96 = 0.43$  it will be seen that the design mV/A/m can be taken to be approximately 0.89 times the tabulated value. Thus the ‘corrected’ voltage drop is given by:

$$10.8 \times 0.89\text{ V} = 9.6\text{ V}$$

There is therefore no further need to increase the conductor cross-sectional area.

A more accurate estimation of the voltage drop, if considered necessary, means first calculating  $t_1$ .

$$t_1 = 45 + \frac{41^2}{96^2} (90 - 30)^\circ\text{C} = 55.9^\circ\text{C}$$

so that:

$$\text{design mV/A/m} = \left( \frac{230 + 55.9}{230 + 90} \right) \times 2.5 \text{ milliohms/m} = 2.2 \text{ milliohms/m}$$

and

$$\text{voltage drop} = \frac{2.2 \times 105 \times 41}{1000} \text{ V} = 9.5 \text{ V}$$

Now check that protection against indirect contact is obtained, using the simple approach. From Table 3.1 Column 6 (because Table 54.3 applies):

$$(R_1 + R_2)/m = 5.41 \text{ milliohms/m}$$

$$R_1 + R_2 = \frac{5.41 \times 105}{1000} \text{ ohm} = 0.57 \text{ ohm}$$

The earth fault loop impedance is given by:

$$Z_s = \sqrt{(0.2 + 0.57)^2 + 0.08^2} \text{ ohm} = 0.774 \text{ ohm}$$

From Table 41.4 it is found that the maximum value of  $Z_s$  for a disconnection time of 5 s is 1.04 ohm so the circuit meets this requirement.

It remains to check the thermal adequacy of the protective circuit.

Table 54.3 applies so that  $k = 143$ .

The earth fault current is given by:

$$\frac{230}{0.774} \text{ A} = 297 \text{ A}$$

From the time/current characteristic in Appendix 3 of BS 7671 the disconnection time is found to be approximately 1.0 s.

$$k^2 S^2 = 143^2 \times 6^2 \text{ A}^2 \text{ s} = 736\,164 \text{ A}^2 \text{ s}$$

$$I_{\text{ef}}^2 t = 297^2 \times 1.0 \text{ A}^2 \text{ s} = 88\,209 \text{ A}^2 \text{ s}$$

The circuit conductors are adequately protected.

Because the fuses are intended to give both overload and short circuit protection, Regulation 435.1 applies and no further checks are required.

### Example 6.5

A 400 V three-phase three-wire circuit is run in multicore armoured 70°C thermoplastic insulated cable having copper conductors. The cable is clipped direct and it is intended to use the armouring as the cpc. The circuit is to be protected against overload and short circuit by a T.P. Type B mcb.  $I_b$

= 26 A,  $t_a = 40^\circ\text{C}$  and  $l = 48\text{ m}$ . The voltage drop must not exceed 5% of the nominal voltage and the disconnection time under earth fault conditions is not to exceed 5 s.

If  $R_b = 0.06\text{ ohm}$ ,  $X_b = 0.10\text{ ohm}$ ,  $R_E = 0.12\text{ ohm}$  and  $X_E = 0.16\text{ ohm}$  at the point of installation of the mcb, design the circuit for compliance with BS 7671.

### Answer

Select the nominal current for the mcb from the standard ratings. Thus  $I_n = 32\text{ A}$ .

The symmetrical three-phase short circuit current at the point of installation of the mcb is given by:

$$\frac{230}{\sqrt{0.06^2 + 0.10^2}}\text{ A} = 1972\text{ A}$$

A Type B mcb to BS EN 60989 having a 3000 A breaking capacity is therefore suitable.

First determine the cable conductor cross-sectional area.

From Table 4B1,  $C_a = 0.87$ .

$$I_t = 32 \times \frac{1}{0.87}\text{ A} = 36.8\text{ A}$$

From Table 4D4A Column 3 it is found that the minimum conductor cross-sectional area is  $6\text{ mm}^2$  having  $I_{ta} = 42\text{ A}$ .

Check for voltage drop.

From Table 4D4B Column 4,  $\text{mV/A/m} = 6.4\text{ milliohms/m}$ .

$$\text{Voltage drop} = \frac{26 \times 6.4 \times 48}{1000}\text{ V} = 8\text{ V} = 2\%$$

The voltage drop is therefore within the required maximum.

Now check the circuit under earth fault conditions.

From Table 3.11 the resistance of the steel wire armour is:

$4.6\text{ milliohms/m}$  at  $20^\circ\text{C} = 4.6 \times 1.18\text{ milliohms/m}$  at  $60^\circ\text{C} = 5.43\text{ milliohms/m}$

From Table 3.1 the resistance of a phase conductor is  $3.70\text{ milliohms/m}$ .

Thus:

$$(R_1 + R_2) = \frac{(3.70 + 5.43)}{1000} \times 48\text{ ohm} = 0.438\text{ ohm}$$

$$Z_s = \sqrt{(0.438 + 0.12)^2 + 0.16^2}\text{ ohm} = 0.58\text{ ohm}$$

From Table 41.3 the maximum permitted value for  $Z_s$  is  $1.44\text{ ohm}$  so the circuit complies.

It remains to check whether the cpc is adequate. To do this it is necessary to consult the cable manufacturer's data.

Assume that the armour cross-sectional area is found to be  $37\text{ mm}^2$ .

From Table 54.3,  $k$  for the conductor is 115, and from Table 54.4,  $k$  for the armour is 51. To comply with Table 54.7 the minimum armour cross-sectional area should be:

$$\frac{115}{51} \times 6 \text{mm}^2, \text{ i.e. } 13.53 \text{mm}^2$$

The armour does comply and therefore there is no need to check that the circuit complies with the adiabatic equation.

Because the mcb is providing both overload and short circuit protection and has adequate breaking capacity, there is no need to check compliance with the adiabatic equation under short circuit conditions.

One could, of course, provide many more examples of final circuits but it is felt that those which have been given show the approach that should be used.

When designing installations such as those shown in Figures 3.1 and 5.9, the first task facing the designer is to determine the most suitable locations for the sub-distribution boards. The route lengths of the distribution circuits can then be calculated and an assessment made of the design current in those circuits. That assessment requires a detailed knowledge of the complete installation including the operating conditions that will be encountered. Armed with this information the designer will be able to determine the appropriate diversity factors in order to obtain the design currents in the distribution circuits.

BS 7671 does not **demand** that diversity be taken into account but, for the economic design of an installation, diversity cannot be ignored. The diversity factors used must not be optimistic; an adequate margin of safety must always be allowed.

As indicated in Regulation 433.1, which gives the general requirement concerning overload protection, circuits shall be so designed that small overloads of long duration are unlikely to occur. This could well happen if the assessment of the design current in distribution circuits was based on optimistic diversity factors.

The designer should also consider the possible future growth of the installation. The subject of diversity is, however, outside the scope of this present book.

The next stage in design is to apportion the permitted voltage drop between the distribution circuits and the final circuits. Regulation 525.3 points towards Appendix 12 for the acceptable total voltage drop, i.e. between the origin of the installation and the current-using equipment. The values of 3% for lighting circuits and 5% for other circuits have a 'deemed to satisfy' status.

Regulations 525.1 and 525.2, which are the basic regulations, allow higher voltage drops provided that the resulting voltage at the terminals of the current-using equipment is not less than any lower limit specified in the relevant British Standard or, where there is no British Standard, is such as not to impair the safe functioning of that equipment. Note that there may be conditions where a voltage drop lower than that given in Appendix 12 is required. Having decided on the voltage drop which can be permitted in the final circuits, the detailed design of those circuits can be undertaken. At this stage these designs are provisional because it may be that the calculated conductor cross-sectional areas are unduly large. For example, it might be that the conductors could not be accommodated in the equipment or accessory terminations.

It may therefore be necessary to examine the number of final circuits grouped together, whether circuits running through areas of high ambient temperature or in contact with thermally insulating material could be re-routed, and so on. These changes should be deferred until after the distribution

circuits have been designed because if their voltage drops are well within their allocated values, some increase in the voltage drops in some of the final circuits may be possible.

Here let it be assumed that the final circuits have been designed and it remains to calculate the conductor cross-sectional areas for the distribution circuits, to check the voltage drops and to check compliance with the requirements for protection against indirect contact both for meeting maximum disconnection times and for the thermal adequacy of the circuit live and protective conductors under earth fault conditions.

Furthermore the prospective short circuit currents at the distribution boards have to be calculated to check that there is adequate co-ordination between protective devices and, unless Regulation 435.1 is invoked, the adequacy of the thermal protection of the circuit conductors.

The design approach consists of calculating the appropriate circuit resistances and impedances but, as already indicated in earlier chapters, these are based on different temperatures depending on which aspect is being checked.

### Example 6.6

The installation as shown in Figure 6.1 is fed from a 200 kVA three-phase delta/star transformer having a nominal secondary voltage (on load) of 400 V between phases and 230 V phase-to-neutral, the neutral being distributed throughout the installation. The resistance per phase of the transformer is 0.016 ohm and the reactance per phase is 0.04 ohm. The ambient temperature throughout the installation can be assumed to be 30°C.

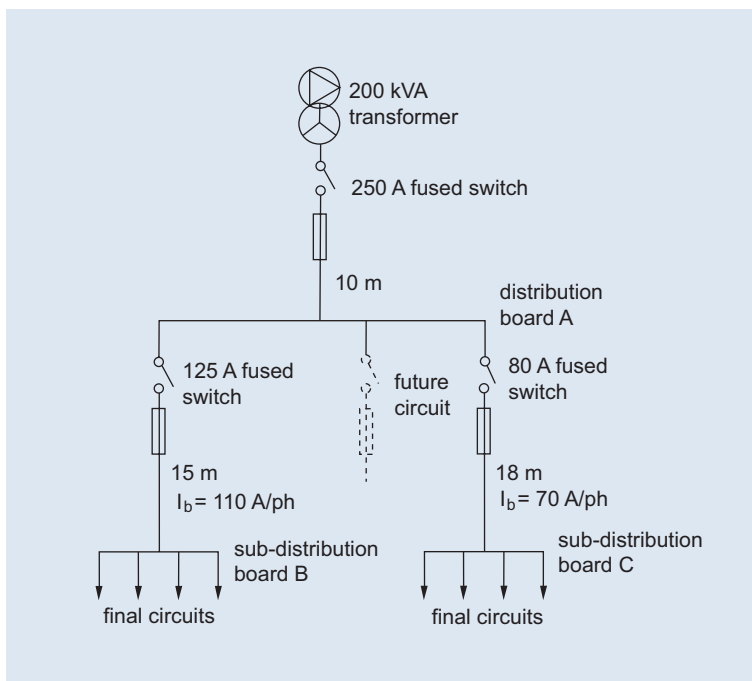

Figure 6.1 Installation schematic diagram for Example 6.6.

The estimated currents in the distribution circuits are as shown in the figure together with the nominal ratings of the fused switches (fuses to BS 88–2.2 ‘gG’) intended in all cases to give both overload and short circuit protection to the distribution circuits concerned. The distribution circuits are to be run in multicore armoured 90°C thermosetting insulated cables, clipped direct, and the estimated route lengths are as shown. Each circuit is not grouped with other circuits. The voltage drop from the transformer to distribution board A is not to exceed 1.5 V line-to-line. For each of the distribution circuits from distribution board A to the sub-distribution boards B and C, the voltage drop is not to exceed 3 V line-to-line.

Determine the conductor cross-sectional areas of the distribution cables and check compliance with the requirements for overcurrent protection and protection against indirect contact.

### Answer

First determine the conductor cross-sectional areas. As the ambient temperature can be taken to be 30°C and there is no grouping, there are no correction factors to be applied.

Thus from the transformer to distribution board A:

$$I_t = I_n = 250 \text{ A}$$

From Table 4E4A Column 3 it is found that the minimum conductor cross-sectional area that can be used is 95 mm<sup>2</sup> having  $I_{ta} = 289 \text{ A}$ .

From distribution board A to sub-distribution board B, again from Table 4E4A Column 3, the minimum conductor cross-sectional area is 35 mm<sup>2</sup> having  $I_{ta} = 154 \text{ A}$ .

From distribution board A to sub-distribution board C,  $I_t = I_n = 80 \text{ A}$ . From Table 4E4A Column 3 the minimum conductor cross-sectional area for this cable is 16 mm<sup>2</sup> having  $I_{ta} = 94 \text{ A}$ .

At this point in design the above conductor cross-sectional areas give compliance only with the requirements for overload protection. As the prospective short circuit circuits have not yet been determined it is too early to claim that the overcurrent protective devices have adequate breaking capacity and it is not possible to invoke Regulation 435.1, i.e. it is not possible to claim the circuits concerned are adequately protected against short circuit.

But first check the voltage drops.

Table 6.1 compiled from Column 4 of Table 4E4B gives the values of mV/A/m.

As no indication is given of the power factor in any of the distribution circuits the  $(\text{mV/A/m})_z$  values are used in each case and the voltage drops are calculated as follows.

From the transformer to distribution board A:

$$\text{voltage drop} = \frac{0.45 \times 10 \times 250}{1000} \text{ V} = 1.125 \text{ V}$$

**Table 6.1** Voltage drop values of mV/A/m (milliohms/m)

	$(\text{mV/A/m})_r$	$(\text{mV/A/m})_x$	$(\text{mV/A/m})_z$
16 mm <sup>2</sup>	—	—	2.5
35 mm <sup>2</sup>	1.15	0.135	1.15
95 mm <sup>2</sup>	0.43	0.130	0.45

(Here  $I_n = 250\text{ A}$  has been used because, as indicated, there is a further distribution circuit to be taken from distribution board A.)

From distribution board A to sub-distribution board B:

$$\text{voltage drop} = \frac{1.15 \times 15 \times 110}{1000} \text{ V} = 1.9 \text{ V}$$

From distribution board A to sub-distribution board C:

$$\text{voltage drop} = \frac{2.50 \times 18 \times 70}{1000} \text{ V} = 3.15 \text{ V}$$

This voltage drop does not meet the specified limit so the conductor cross-sectional area is increased to  $25\text{ mm}^2$  having  $I_t = 124\text{ A}$  and  $(\text{mV/A/m})_r = 1.6$ ,  $(\text{mV/A/m})_x = 0.140$ ,  $(\text{mV/A/m})_z = 1.65$ . The voltage drop from distribution board A to sub-distribution board C is now  $2.08\text{ V}$ .

All the circuits now meet the specified limitation in voltage drop.

Now determine the prospective short circuit currents.

At the terminals of the transformer:

$$I_{\text{psc}} = \frac{230}{\sqrt{0.016^2 + 0.04^2}} \text{ A} = 5339 \text{ A}$$

As a matter of interest another way of determining this prospective short circuit current is to use the %Z of the transformer, this being given on the transformer rating plate and:

$$I_{\text{psc}} = \frac{\text{kVA rating} \times 1000}{\sqrt{3} \times U_L} \times \frac{100}{\%Z} \text{ A}$$

The other important relationships with transformers are:

$$Z \text{ phase} = \frac{U_L^2 \times \%Z}{\text{kVA rating} \times 100\,000} \text{ ohm}$$

$$R \text{ phase} = \frac{U_L^2 \times \%R}{\text{kVA rating} \times 100\,000} \text{ ohm}$$

$$X \text{ phase} = \frac{U_L^2 \times \%X}{\text{kVA rating} \times 100\,000} \text{ ohm}$$

where:

%R is the percentage resistance

%X is the percentage reactance

$U_L$  is the line-to-line voltage.

In the present case:

$$Z_{ph} = \sqrt{0.016^2 + 0.04^2} \text{ ohm} = 0.0431 \text{ ohm}$$

$$\%Z = \frac{0.0431 \times 200 \times 100\,000}{400^2} = 5.4\%$$

Using this to obtain the prospective short circuit current:

$$I_{psc} = \frac{200 \times 1000}{\sqrt{3} \times 400} \times \frac{100}{5.4} \text{ A} = 5346 \text{ A}$$

Because the prospective short circuit is only 5346 A and the protective devices for the two circuits from distribution board A to the sub-distribution boards B and C are BS 88-2.2 'gG' fuses having breaking capacities considerably in excess of 5346 A there is strictly no need to determine the prospective short circuit current at distribution board A.

In the present case, because all the fuses are providing overload protection as well as short circuit protection and have adequate breaking capacity, Regulation 435.1 applies. So it is not necessary to check the thermal capabilities of the cables under short circuit conditions using the adiabatic equation of Regulation 434.5.2.

Notwithstanding the above remarks and simply to illustrate the method to be used, the prospective short circuit currents at the three distribution boards are now calculated. The resistance and reactance of one phase conductor of the circuit concerned at 20°C (or some other temperature, if appropriate, because the premise is that the fault could occur in a 'cold' installation) need to be known to calculate these prospective short circuit currents. The resistance and reactance of the neutral conductor are not needed.

The necessary resistance/metre and reactance/metre values may be obtained directly from the cable manufacturer's data because these sometimes give these values at 20°C.

Alternatively the mV/A/m values given in Appendix 4 of BS 7671 can be used, 'correcting' them to 20°C.

Using the latter method, for the main incoming circuit:

$$\begin{aligned} R_1 &= \frac{(\text{mV/A/m})_r \times 1 \times (230 + 20)}{\sqrt{3} \times 1000 \times (230 + 90)} \text{ ohm} \\ &= \frac{0.43 \times 10 \times 250}{\sqrt{3} \times 1000 \times 320} \text{ ohm} \\ &= 0.0019 \text{ ohm} \end{aligned}$$

$$\begin{aligned} X_1 &= \frac{(\text{mV/A/m})_x \times 1}{\sqrt{3} \times 1000} \text{ ohm} \\ &= \frac{0.130 \times 10}{\sqrt{3} \times 1000} \text{ ohm} \\ &= 0.00075 \text{ ohm} \end{aligned}$$

The prospective short circuit current at distribution board A is given by:

$$I_{\text{psc}} = \frac{230}{\sqrt{(0.016 + 0.0019)^2 + (0.04 + 0.00075)^2}} \text{ A} = 5168 \text{ A}$$

Similarly for the circuit from distribution board A to sub-distribution board B:

$$R_1 = \frac{1.15 \times 15 \times 250}{\sqrt{3} \times 1000 \times 320} \text{ ohm}$$

$$= 0.0078 \text{ ohm}$$

$$X_1 = \frac{0.135 \times 15}{\sqrt{3} \times 1000} \text{ ohm}$$

$$= 0.0012 \text{ ohm}$$

The prospective short circuit current at distribution board B is given by:

$$I_{\text{psc}} = \frac{230}{\sqrt{(0.016 + 0.0019 + 0.0078)^2 + (0.04 + 0.00075 + 0.0012)^2}} \text{ A} = 4675 \text{ A}$$

For the circuit from distribution board A to sub-distribution board C:

$$R_1 = \frac{1.6 \times 8 \times 250}{\sqrt{3} \times 1000 \times 320} \text{ ohm}$$

$$= 0.013 \text{ ohm}$$

$$X_1 = \frac{0.140 \times 18}{\sqrt{3} \times 1000} \text{ ohm}$$

$$= 0.0015 \text{ ohm}$$

The prospective short circuit current at distribution board C is given by:

$$I_{\text{psc}} = \frac{230}{\sqrt{(0.016 + 0.0019 + 0.013)^2 + (0.04 + 0.00075 + 0.0015)^2}} \text{ A} = 4394 \text{ A}$$

The next stage in design is to check the earth fault loop impedances for the circuits concerned and, at the same time, whether the circuit conductors are thermally protected. To calculate the earth fault loop impedance at distribution board A it is necessary to use the value of  $R_1$  for the main distribution circuit at the assumed temperature under earth fault conditions, i.e. 90°C.

Again the  $(\text{mV}/\text{A}/\text{m})_r$  value can be used:

$$R_1 = \frac{0.43 \times 10}{\sqrt{3} \times 1000} \text{ ohm} = 0.0025 \text{ ohm}$$

$X_1 = 0.00075 \text{ ohm}$  (as before)

The resistance and reactance per metre for the steel wire armour are obtained from Table 3.13 Columns 6 and 7 respectively.

The resistance value has to be corrected to 80°C by multiplying by 1.27. Thus:

$$R_2 = \frac{1.1 \times 10 \times 1.27}{1000} \text{ ohm} = 0.0140 \text{ ohm}$$

$$X_2 = \frac{0.3 \times 10}{1000} \text{ ohm} = 0.003 \text{ ohm}$$

The earth fault loop impedance at distribution board A is given by:

$$\begin{aligned} Z_s &= \sqrt{(0.016 + 0.0025 + 0.0140)^2 + (0.04 + 0.00075 + 0.003)^2} \text{ ohm} \\ &= \sqrt{(0.0325)^2 + (0.0438)^2} \text{ ohm} \\ &= 0.055 \text{ ohm} \end{aligned}$$

The time/current characteristics in Appendix 3 of BS 7671 do not include that for 250 A fuses, hence it is necessary to obtain it from the fuse manufacturer.

A typical earth fault current to give 5 s disconnection time is 1500 A giving a maximum earth fault loop impedance of 0.15 ohm. The main incoming circuit complies for disconnection time.

From the cable manufacturer's data it is found that the gross cross-sectional area of the armour wires is 147 mm<sup>2</sup>.

First check if this cross-sectional area complies with Table 54.7 of BS 7671.

According to that table the cross-sectional area should be at least:

$$\frac{143}{46} \times \frac{95}{2} \text{ mm}^2 = 147.7 \text{ mm}^2$$

Strictly speaking the cable does not comply with Table 54.7, but because this table is known to be an approximation the designer could accept that the difference between 147 and 147.7 mm<sup>2</sup> is within tolerances and the cable is acceptable. However, a computer program would probably reject the cable size selected. A check with the equation given in Regulation 543.1.3 gives the required cross-sectional area of the armour as:

$$\frac{\sqrt{1500^2 \times 5}}{46} = 72.9 \text{ mm}^2$$

The cable therefore complies with Regulation 543.1.1.

To determine the earth fault loop impedance at distribution boards B and C it is first necessary to recalculate the resistance of the phase conductor of the main distribution circuit at the normal operating temperature (90°C for thermosetting insulation). To do this the (mV/A/m)<sub>r</sub> value is used without a correction factor. The reactance remains the same.

The armour temperature was assumed not to rise significantly under earth fault conditions and was previously calculated at the normal operating temperature of 80°C (i.e. 10°C less than the conductor operating temperature). Thus no change is needed.

$$R_1 = \frac{0.43 \times 10}{\sqrt{3} \times 1000} \text{ ohm} = 0.0025 \text{ ohm}$$

$$X_1 = 0.00075 \text{ ohm (as before)}$$

$$R_2 = 0.0140 \text{ ohm (as before)}$$

$$X_2 = 0.003 \text{ ohm (as before)}$$

For the distribution circuit from distribution board A to sub-distribution board B:

$$R_1 = \frac{1.15 \times 15}{\sqrt{3} \times 1000} \text{ ohm}$$

$$= 0.01 \text{ ohm}$$

$$X_1 \text{ as before} = 0.0012 \text{ ohm}$$

From Table 3.13 Columns 6 and 7:

$$R_2 = \frac{2.0 \times 15 \times 1.27}{1000} \text{ ohm}$$

$$= 0.038 \text{ ohm}$$

$$X_2 = 0 \text{ (i.e. negligible)}$$

The earth fault loop impedance at sub-distribution board B is then obtained as follows. Its resistance component is made up of:

● Internal resistance of the transformer	0.016 ohm
● $R_1$ for phase conductor of main distribution circuit (at 90°C)	0.0025 ohm
● $R_2$ for armouring of main distribution circuit (at 80°C)	0.014 ohm
● $R_1$ for phase conductor of distribution circuit to board B (at 90°C)	0.01 ohm
● $R_2$ for armouring of distribution cable to board B (at 60°C)	0.038 ohm
● <b>Total resistance</b>	<b>0.0805 ohm</b>

Its reactance component is made up of:

● Internal reactance of the transformer	0.04 ohm
● $X_1$ for phase conductor of main distribution circuit	0.00075 ohm
● $X_2$ for armouring of main distribution circuit	0.003 ohm
● $X_1$ for phase conductor of distribution circuit to board B	0.0012 ohm
● $X_2$ for armouring of distribution circuit to board B is negligible	0
● <b>Total reactance</b>	<b>0.0449 ohm</b>

Thus:

$$Z_s = \sqrt{0.0805^2 + 0.0449^2} \text{ ohm} = 0.092 \text{ ohm}$$

From Table 41.4 of BS 7671 the maximum earth fault loop impedance for 5 s disconnection is 0.33 ohm so the circuit complies.

To be able to apply Table 54.7 the cross-sectional area for the armour wires has to be at least

$$\frac{143}{46} \times 16 \text{ mm}^2 = 50 \text{ mm}^2$$

A check of the cable manufacturer's data has to be made and it will be found that Table 54.7 will be met, a typical value being 78 mm<sup>2</sup> for the armour cross-sectional area.

For the distribution circuit from distribution board A to sub-distribution board C:

$$R_1 = \frac{1.6 \times 18}{\sqrt{3} \times 1000} \text{ ohm}$$

$$= 0.017 \text{ ohm}$$

$$X_1 \text{ as before} = 0.0015 \text{ ohm}$$

From Table 3.13, Columns 6 and 7:

$$R_2 = \frac{2.3 \times 18 \times 1.27}{1000} \text{ ohm}$$

$$= 0.053 \text{ ohm}$$

$$X_2 = 0 \text{ (i.e. negligible)}$$

The earth fault loop impedance at sub-distribution board C is then obtained as follows.

Its resistance component is made up of:

● Internal resistance of the transformer	0.016 ohm
● $R_1$ for phase conductor of main distribution circuit (at 90°C)	0.0025 ohm
● $R_2$ for armouring of main distribution circuit (at 80°C)	0.014 ohm
● $R_1$ for phase conductor of distribution circuit to board C (at 90°C)	0.017 ohm
● $R_2$ for armouring of distribution cable to board C (at 80°C)	0.053 ohm
● <b>Total resistance</b>	<b>0.1017 ohm</b>

Its reactance component is made up of:

● Internal reactance of the transformer	0.04 ohm
● $X_1$ for phase conductor of main distribution circuit	0.00075 ohm
● $X_2$ for armouring of main distribution circuit	0.003 ohm

- $X_1$  for phase conductor of distribution circuit to board C 0.0015 ohm
- $X_2$  for armouring of distribution cable to board C is negligible 0
- **Total reactance** **0.0452 ohm**

Thus:

$$Z_s = \sqrt{0.1017^2 + 0.0452^2} \text{ ohm} = 0.111 \text{ ohm}$$

This is well within the maximum value of  $Z_s$  for an 80 A BS 88–2.2 ‘gG’ fuse given in Table 41.4, i.e. 0.57 ohm.

Again it will be found that Table 54.7 is met and there is no need to check further the thermal capacity of the armouring under earth fault conditions.



## Appendix: The touch voltage concept

See also: *Touch Voltages in Electrical Installations*, B.D. Jenkins (Blackwell Science, 1993).

The object of BS 7671 includes the provision of requirements concerning protection against electric shock.

Two forms of protection against electric shock are recognized in BS 7671: the first of these is termed 'basic protection', which is protection against contact of persons or livestock with live parts and the second is 'fault protection', which is protection against contact of persons or livestock with exposed-conductive-parts made live by a fault.

The touch voltage concept is concerned with the latter form of electric shock. It is used to determine the magnitude of the voltage to which the person at risk would be subjected in the event of an earth fault occurring in an installation. By assuming values of body resistance, the touch voltage concept can be extended to give an indication of the severity of the electric shock that could be experienced by that person.

A study of the touch voltage concept, which is a very simple concept, gives the installation designer, and others concerned with electrical installations, a fuller understanding of the requirements given in BS 7671 for fault protection.

One often hears or reads the statement that provided an item of electrical equipment (intended to be earthed) is properly earthed it is not possible for a person to receive an electric shock in the event of a fault. The touch voltage concept shows such a statement to be totally incorrect.

The connection of all exposed- and extraneous-conductive-parts, either directly or indirectly, to a common terminal, i.e. the main earthing terminal of the installation, leads to the creation of touch voltages in the event of an earth fault and hence to the shock risk. In a correctly designed and erected electrical installation such a shock risk is **not** eliminated. Where the protective measure is automatic disconnection of supply then in the event of an earth fault, the speed of disconnection should be such that should the person at risk experience an electric shock it will not be a harmful one.

Figure A.1 is the basic simplified schematic diagram for a TN-S system comprising a source of energy and an installation.

- $E_o$  = induced emf (to earth of the source), V
- $Z_1$  = internal impedance of the source, ohm
- $Z_1$  = impedance of the circuit phase conductor, ohm
- $Z_2$  = impedance of the circuit protective conductor, ohm
- $Z_3$  = impedance of the supply cable protective conductor, ohm
- $Z_4$  = impedance of the supply cable phase conductor, ohm

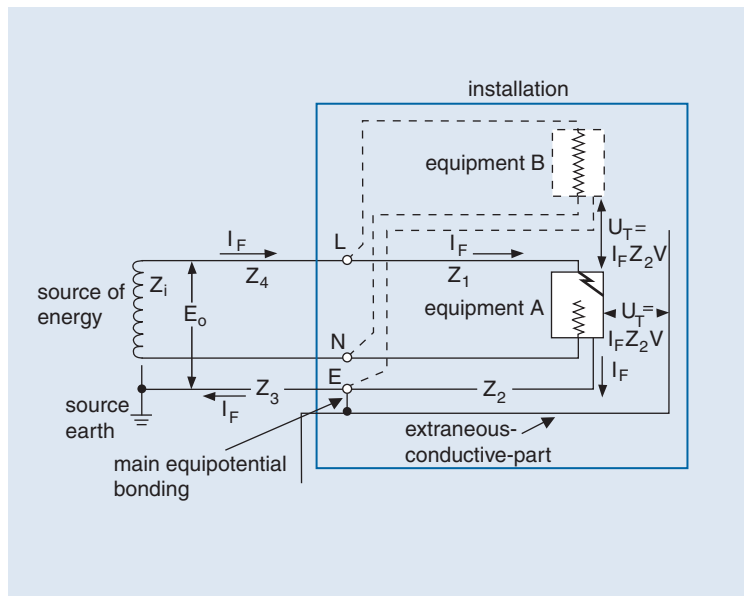

**Figure A.1** Basic schematic diagram for a TN-S system showing touch voltages created by an earth fault.

As shown in Figure A.1 an earth fault has occurred in equipment A, the phase conductor coming into contact with the metallic enclosure of the equipment. The assumption is made that the fault itself is of negligible impedance and is accompanied by an open circuit in the equipment so that no part of the equipment impedance is in the earth fault loop.

The earth fault current,  $I_F$  is given by:

$$I_F = \frac{E_o}{Z_i + Z_1 + Z_2 + Z_3 + Z_4} \text{ A} = \frac{E_o}{Z_s} \text{ A} \quad (1)$$

$Z_s$  is the earth fault loop impedance.

Now  $Z_i + Z_3 + Z_4 = Z_E$ , i.e. that part of  $Z_s$  which is external to the installation, so that:

$$I_F = \frac{E_o}{Z_E + Z_1 + Z_2} \text{ A} \quad (2)$$

When the circuit conductors have a cross-sectional area of less than  $35 \text{ mm}^2$ , their resistance may be used instead of their impedance and a sufficient degree of practical accuracy is obtained if  $U_o$ , the nominal voltage to earth of the supply, is used instead of  $E_o$ . Thus:

$$I_F = \frac{U_o}{Z_E + R_1 + R_2} \text{ A} \quad (3)$$

If consideration is limited to the case where the person at risk is inside the shock protection zone (i.e. the so-called equipotential zone created by the main equipotential bonding) and therefore is not directly in contact with the general mass of earth, then in the event of an earth fault as shown in Figure A.1, if the person simultaneously touches the extraneous-conductive-part and the exposed-conductive-part of the faulty equipment while the fault current is allowed to persist, he or she will be subjected to the voltage  $U_T$ .  $U_T$  is the touch voltage:

$$U_T = I_F R_2 \text{ V} = U_o \left( \frac{R_2}{Z_E + R_1 + R_2} \right) \text{ V} \quad (4)$$

‘Touch voltage’ is a term which does not appear in BS 7671, but the term ‘Prospective Touch Voltage’ is defined in the International Electrotechnical Vocabulary as ‘Voltage between conductive parts when those parts are not being touched by a person or an animal’. The term is also used in BS EN 61140, ‘Protection against electric shock. Common aspects for installation and equipment’, in relation to protection by automatic disconnection of supply. In this Appendix the term is taken to be ‘the voltage between simultaneously accessible exposed- and extraneous-conductive-parts’ that may exist in the event of an earth fault.

Again for conductors of cross-sectional area not exceeding 35 mm<sup>2</sup>, if the phase and protective conductors of a circuit are of the same material and are run over the same route:

$$\frac{R_2}{R_1} = \frac{A_1}{A_2} = m$$

where  $A_1$  = cross-sectional area of the phase conductor, in mm<sup>2</sup>

$A_2$  = cross-sectional area of the protective conductor, in mm<sup>2</sup>

Equation 4 then becomes:

$$U_T = U_o \frac{m}{(Z_E/R_1) + 1 + m} \text{ V} \quad (5)$$

Equation 5 is, therefore, the basic touch voltage equation.

From it a number of important points emerge.

For a particular value of  $Z_E$  and of ‘m’, as  $R_1$  increases, the denominator decreases so that  $U_T$  increases. In other words, for a particular circuit, the maximum touch voltage occurs when the earth fault is at the remote end (for a ring circuit, when the earth fault is at the midpoint).

For a particular value of  $R_1$  and of ‘m’, as  $Z_E$  decreases, the denominator decreases so that  $U_T$  increases. In other words, for a particular circuit the touch voltage can approach but never quite reach the value obtained by putting  $Z_E = 0$  in equation 5 (the basic touch voltage equation).

This gives the asymptotic value denoted here by  $U_A$ . Thus:

$$U_A = U_o \left( \frac{m}{m+1} \right) \text{ V}$$

Table A.1 is based on the flat twin-core and three-core with cpc 70°C thermoplastic insulated and sheathed cables, but it is equally applicable to single-core cables.

**Table A.1** Values of  $m$  and  $U_A/U_o$  for flat twin cable.

Phase conductor cross-sectional area, mm <sup>2</sup>	Protective conductor cross-sectional area, mm <sup>2</sup>	$m$	$U_A/U_o$	$U_A$ when $U_o = 230$ V, volts
1	1	1	0.5	115
1.5	1	1.5	0.6	138
2.5	1.5	1.67	0.625	144
4	1.5	2.67	0.728	167
6	2.5	2.4	0.706	162
10	4	2.5	0.714	164
16	6	2.67	0.728	167

Figure A.2 shows a family of curves, each curve for a particular value of  $m$ , of  $U_T$  plotted against  $R_1$  when  $U_o = 230$  V and  $Z_E = 0.8$  ohm. Figure A.3 shows a family of curves, each curve for a particular value of  $Z_E$  when  $U_o = 230$  V and  $m = 2.5$  and superimposed on this family are vertical lines giving values of  $R_1$  for different values of  $I_b$  to give a 5% voltage drop in a 230 V single-phase circuit.

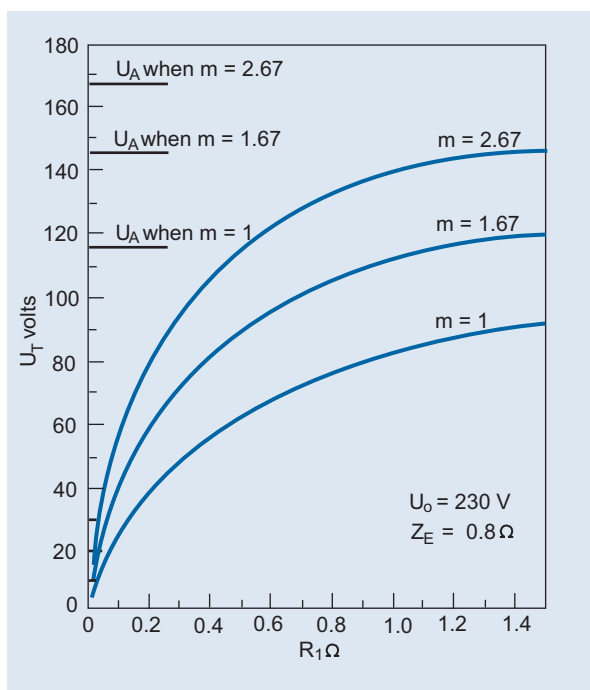
**Figure A.2** Touch voltage against resistance of phase conductor ( $R_1$ ) for various  $m$  values when  $U_o = 230$  V and  $Z_E = 0.80$  ohm.

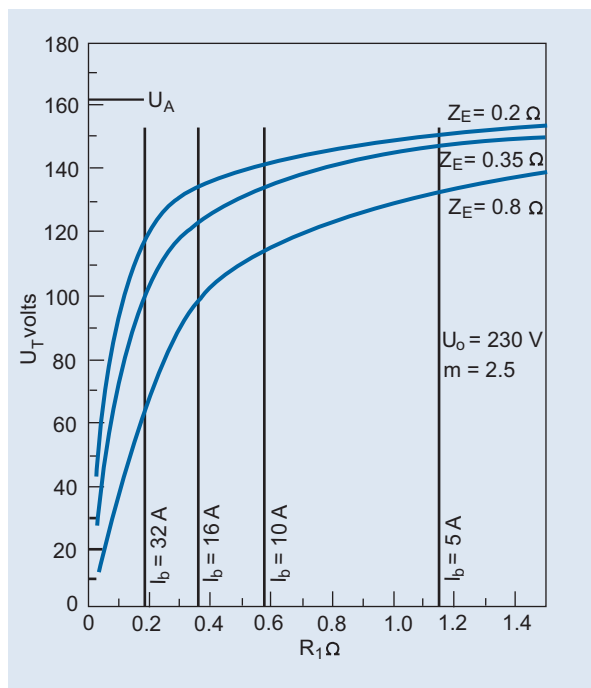

**Figure A.3** Touch voltage against resistance of phase conductor ( $R_1$ ) for various  $Z_E$  values when  $U_o = 230$  V and  $m = 2.5$ . The vertical lines for various values of  $I_b$  correspond to a permitted voltage drop of 5%.

Returning for the moment to Figure A.1 it will be seen that the touch voltage,  $U_T = I_f Z_2$  V also exists between the exposed conductive parts of the faulty equipment and those of the healthy equipment fed by another circuit because of the common connection of the protective conductors of both circuits to the main earthing terminal (E) of the installation.

Figure A.4 shows the schematic diagram for a multi-outlet radial circuit and the earth fault is at the remote outlet.  $x_1$ ,  $x_2$  and  $x_3$  are the fractional distances of the protective conductor ( $x_1 + x_2 + x_3 = 1$ ). It will be seen that touch voltages of different magnitudes exist, even between exposed conductive parts of two healthy equipments, but the maximum value occurs between the exposed-conductive-part of the faulty equipment and extraneous-conductive-parts.

Thus, in the event of an earth fault, the zone created by the main equipotential bonding is far from 'equipotential', hence the preference for calling the zone the 'protected' zone. The zone is truly equipotential only when the earth fault occurs outside the zone. When this happens the main earthing terminal will take up some potential with respect to true earth and all the exposed- and extraneous-conductive-parts will take up that potential.

Having considered the magnitude of the touch voltages occurring in an installation, at least those related to a circuit connected directly at the origin of the installation and not via, for example, a sub-distribution board, there remains the aspect of what is considered to be the time for which those touch voltages can persist without causing danger.

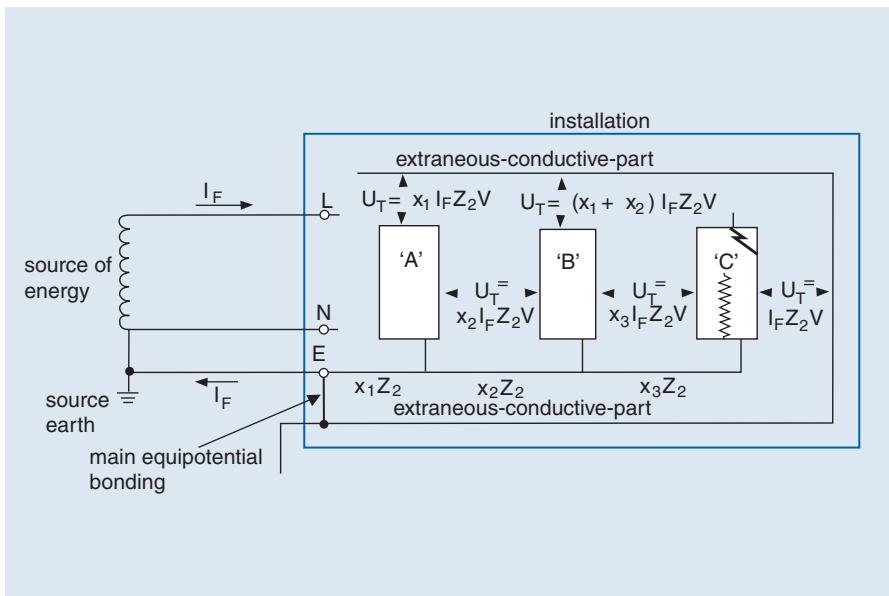

**Figure A.4** Basic schematic diagram for a multi-outlet circuit in a TN-S system showing touch voltages created by an earth fault.

Based on the data given in the IEC Technical Specification 60479-1:2005 *Effects of current on human beings and livestock* – (identical to the BSI Publication DD IEC/TS 60479-1) and using certain values for the resistance of the human body, the current/time zones of that publication were translated into the two touch voltage duration curves as shown in Figure A.5 for 50 Hz a.c.

The curve L1 relates to Condition 1, defined as normally dry situations, where the surface on which the person at risk is standing presents some resistance (to the general mass of earth) and that person is assumed to have dry or moist skin.

The curve L2 relates to Condition 2, defined as wet locations, where that surface does not present any resistance and the person is assumed to have wet skin.

The international committee IEC TC 64 decided not to adopt these touch voltage duration curves into the international Chapter 41 but adopted the maximum disconnection time used in BS 7671 of 0.4 s for circuits having  $U_o = 230 V$  in TN systems.

Limiting consideration to Condition 1 it will be noted that when the touch voltage is 50 V the disconnection time can be 5 s **or greater**. In other words, if the touch voltage is 50 V or less automatic disconnection of the supply is not required from consideration of electric shock. Disconnection is required, however, from thermal considerations. This value of 50 V is known as the conventional touch voltage limit ( $U_T$ ).

The earth fault loop impedance,  $Z_s$ , at the remote end of a radial circuit (or at the midpoint of a ring circuit) determines the magnitude of the earth fault current,  $I_F$ . This in turn determines the time of disconnection of the overcurrent protective device being used to provide protection against indirect contact. The maximum touch voltage which can be tolerated for that disconnection time is

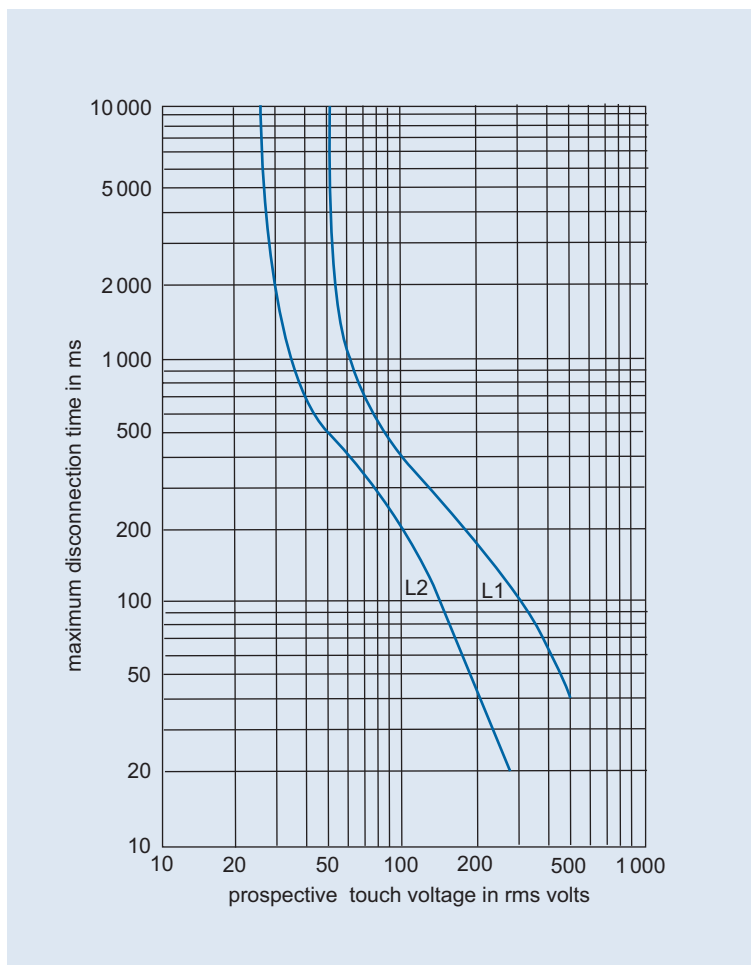
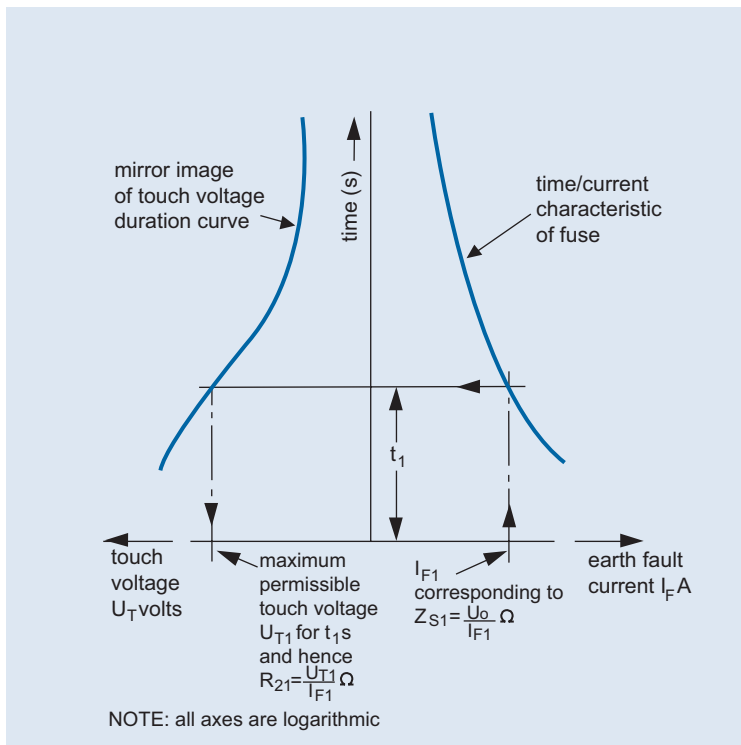

**Figure A.5** Touch voltage duration curves derived from IEC Publication.

then obtained from the relevant touch voltage duration curve. It is an easy matter to check whether the resistance of the circuit protective conductor ( $R_2$ ) is such that the calculated touch voltage is less.

There is, however, a very simple graphical method that can be used, developed by one of the authors of this book some years ago, which requires the production of what are called 'impedance characteristics' for fuses and miniature circuit breakers (mcbs). These are obtained in the following manner.

Figure A.6 shows the time/current characteristic for an HBC fuse and the touch voltage duration curve, but solely for the purpose of explanation the mirror image of the latter has been used.



**Figure A.6** Derivation of an impedance characteristic.

Take any value of earth fault current such as  $I_{F1}$ . This corresponds to an earth fault loop impedance  $Z_{S1}$  given by:

$$Z_{S1} = \frac{U_o}{I_{F1}} \text{ ohm}$$

From the time/current characteristic, obtain the corresponding disconnection time  $t_1$ . Then from the touch voltage duration curve, obtain the maximum value of the touch voltage  $U_{T1}$  which can be allowed to persist for this time  $t_1$ .

The maximum permitted value of the circuit protective conductor resistance is then given by:

$$R_{21} = \frac{U_{T1}}{I_{F1}}$$

On plain graph paper plot  $R_{21}$  against  $Z_S$ .

This procedure is then repeated for other chosen values of earth fault current.

In producing an impedance characteristic there is no point in considering values of the disconnection time  $t$  below that value on the touch voltage duration curve corresponding to  $U_T$  being equal to  $U_o$ .

For values of  $Z_s$  greater than that corresponding to a 5 s disconnection time, the maximum permissible value of  $R_2$  is no longer dependent on the time/current characteristic of the protective device concerned but varies linearly with  $Z_s$  and is given by:

$$R_2 = \frac{U_L}{U_o} \times Z_s \text{ ohm}$$

For Condition 1,  $U_L = 50 \text{ V}$  and if  $U_o = 230 \text{ V}$ ,  $R_2 = 0.217 Z_s$ .

Using the above procedure the following impedance characteristics have been developed, all for  $U_o = 230 \text{ V}$  and Condition 1.

- Figure A.7 25 A BS 88 fuse
- Figure A.8 30 A BS 3036 fuse
- Figure A.9 20 A BS EN 60898 Type B mcb

When the resistance of the cpc is limited to the nadir value,  $R_{2N}$ , the 0.4 s maximum disconnection time for socket outlet circuits can be increased to 5 s. But it also means that, even if the earth fault itself has some impedance or if part of the load impedance is on the earth fault path, the circuit will still comply with the touch voltage curve.

Examination of the time/current characteristics for mcbs given in Appendix 3 of BS 7671 shows that, for a particular type and rating of mcb, the prospective currents for 0.1 s, 0.4 s and 5 s disconnection times are of one value. Thus there is no practical use of the nadir value for mcbs because the maximum permitted earth fault loop impedances for these times are of one value. In any event, the 0.1 s disconnection time is below the 0.16 s maximum allowed in the touch voltage duration curve for a touch voltage of 230 V and within the so-called equipotential zone of an installation having  $U_o = 230 \text{ V}$  the touch voltage cannot, in fact, attain that value.

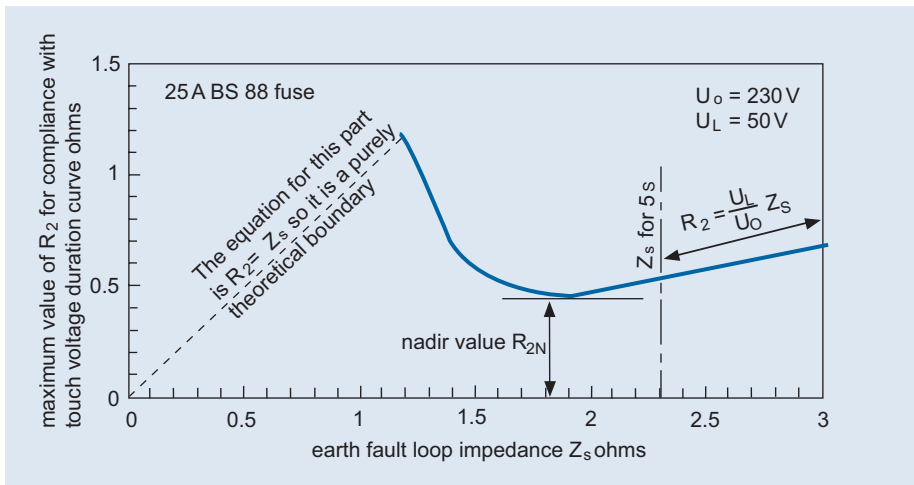

Figure A.7 Impedance characteristic for a BS 88 'gG' fuse.

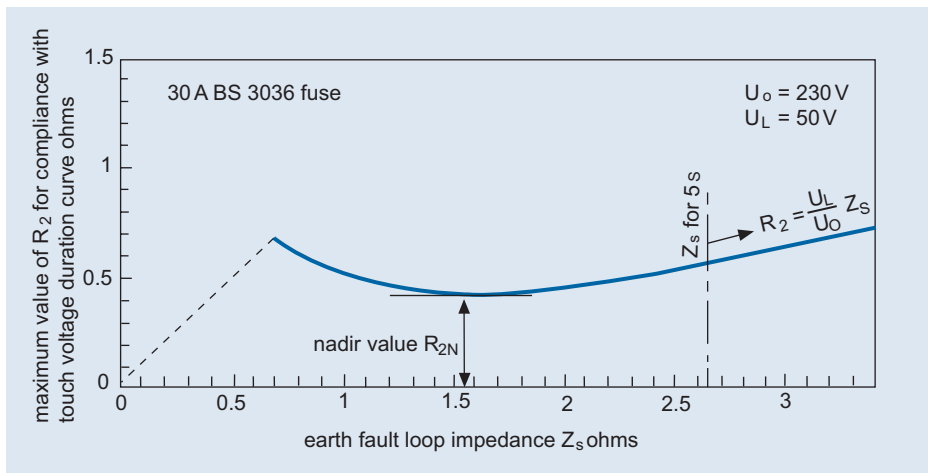

Figure A.8 Impedance characteristic for a BS 3036 semi-enclosed fuse.

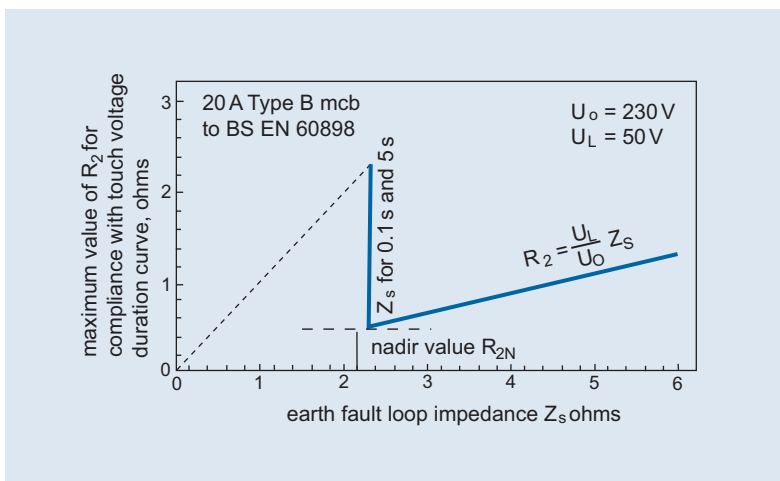
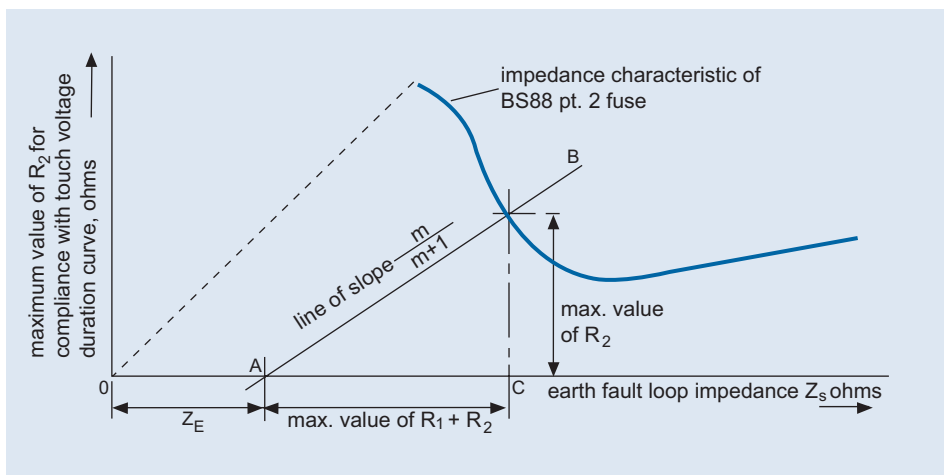
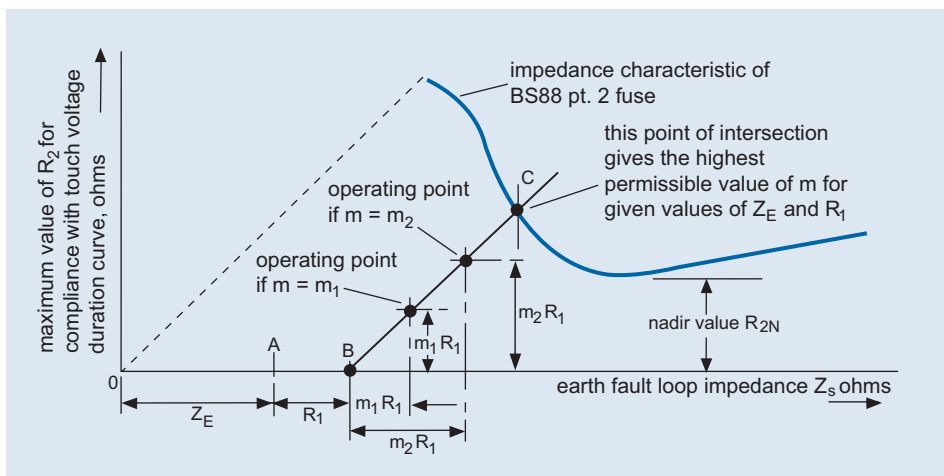

Figure A.9 Impedance characteristics for a Type B mcb.

Figures A.10 and A.11 show the two basic ways in which the impedance characteristic may be used for design purposes. Figure A.10 is used for cases where the ‘m’ value is known, e.g. in flat two-core and three-core thermoplastic insulated and sheathed cables. The line AB is the locus of operation and where it meets the impedance characteristic this gives the maximum value of  $(R_1 + R_2)$  that can be tolerated and this can then be translated into maximum circuit length. Figure A.11 is used for cases where  $Z_E$  and  $R_1$  are known and one wishes to determine the maximum value of ‘m’ which can be tolerated, i.e. the minimum cross-sectional area for the circuit protective conductor. The line BC is the locus of operation and its point of intersection with the impedance characteristic gives the maximum tolerable value of ‘m’.



**Figure A.10** Using impedance characteristic to determine maximum tolerable value of  $(R_1 + R_2)$  and  $R_2$ .

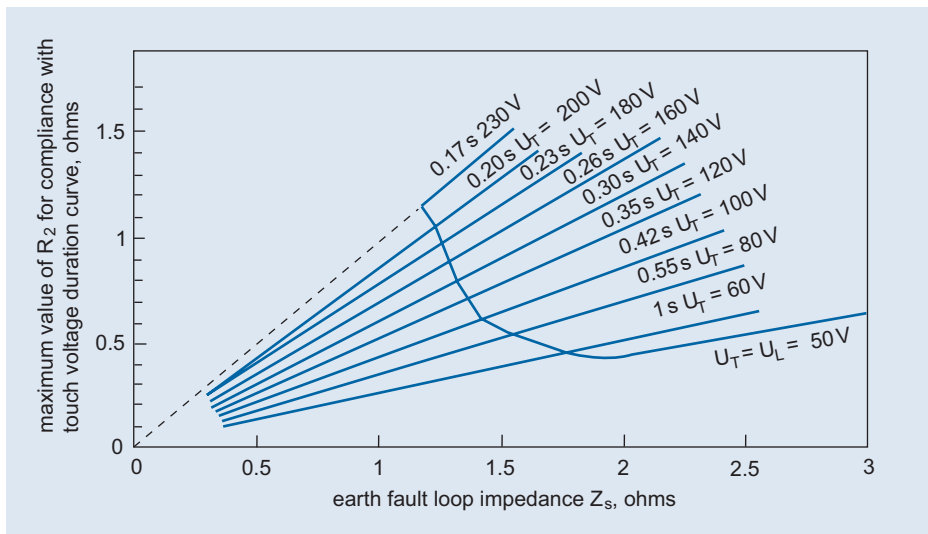

**Figure A.11** Using impedance characteristic to determine maximum tolerable value of  $m$ .

It is necessary in both cases to check that the circuit meets the thermal requirements of Chapter 54 of BS 7671.

The particular advantage of using impedance characteristics is that there is no need to calculate the touch voltage as such, but various values of touch voltage can be constructed on the impedance characteristic as indicated in Figure A.12.

For a touch voltage of  $U_T$  the slope of the corresponding line is given by  $U_T/U_o$ . It would therefore seem that the impedance characteristic (and the touch voltage concept itself) could be used as a design approach and it would be practicable to check compliance by measuring  $Z_E$  and  $(R_1 + R_2)$ .



**Figure A.12** Impedance characteristic and superimposed touch voltage lines.

Certainly for single-phase circuits meeting a 5% limitation in voltage drop, there is no difficulty in meeting the touch voltage duration curve and often meeting the  $R_{2N}$  limit presents no problem. For three-phase circuits compliance with the touch voltage duration curve is a little more difficult but not impossible.

In practice the problem arises because either deliberate supplementary bonding is used or there is a fortuitous contact between exposed-conductive-parts and extraneous-conductive-parts. For example, returning to Figure A.1, the exposed-conductive-parts of equipment A could be locally bonded to the extraneous-conductive-part, because the metallic enclosure of the equipment could be bolted to a stanchion or other metallic part of the building structure.

In either case the touch voltage between the exposed-conductive-parts of the faulty equipment and such parts of other circuits or extraneous-conductive-parts not associated with the local bonding is far less than the design value. As indicated in Figure A.13, the locus of operation will no longer be a straight line. As shown in Figure A.13 the design value is outside the impedance characteristic but, either because of supplementary bonding or a fortuitous earth current path, the circuit actually complies with the touch voltage duration curve. The touch voltage between the exposed-conductive-parts of the faulty equipment and the extraneous-conductive-part to which the bonding has been made will be usually very low.

All the previous comments have related to the shock risk hand-to-hand. Referring back to Figure A.1, the exposed-conductive-parts of the faulty equipment will attain a potential above that of the reference Earth. The floor on which the person is standing is considered to be an extraneous-conductive-part and that person is subjected to the shock risk hand-to-feet when he touches the exposed-conductive-parts of the faulty equipment.

The potential of those exposed-conductive-parts above the reference Earth can be taken to be  $I_F(Z_2 + Z_3)V$ , but the current through the person's body hand-to-feet will now be determined by the resistance of the body, that of the floor on which the person is standing, and that of the person's footwear.

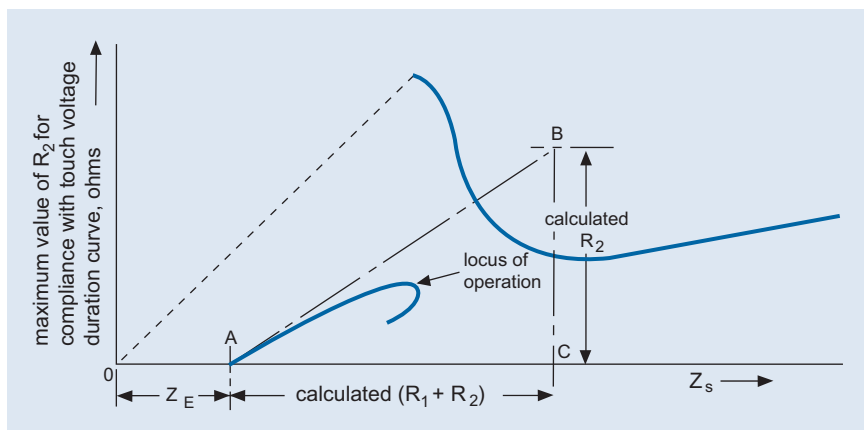

**Figure A.13** Showing effect of supplementary bonding.

Finally, consider the case of final circuits fed from a sub-distribution board, as shown in Figure A.14, where  $R_{21}$  is the resistance of the protective conductor of one of the final circuits and  $R_{22}$  is the resistance of the protective conductor to the sub-distribution board.

When there is no local equipotential bonding (or fortuitous path to earth) at the board and the fault has occurred in a final circuit rated at more than 32 A, which normally has no limitation for touch voltage but should disconnect within 5 s, the touch voltage from exposed-conductive-parts of a **healthy** circuit feeding socket-outlets to the extraneous-conductive-part could be higher than the acceptable value.

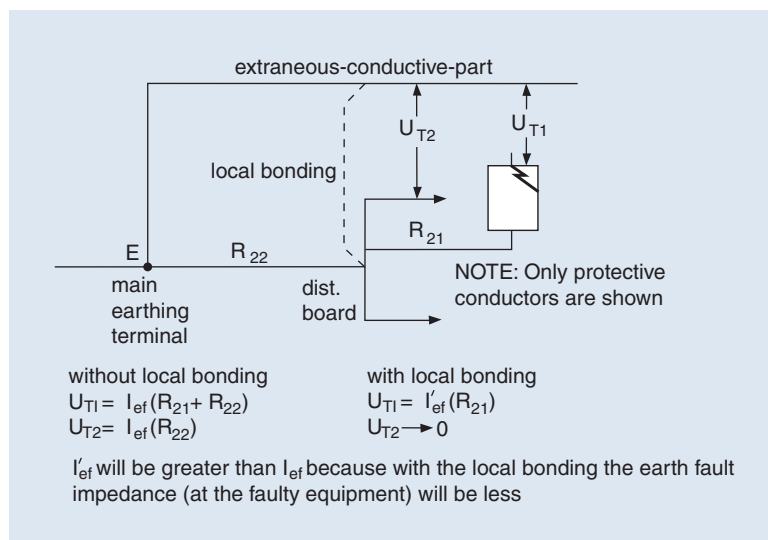

**Figure A.14** Touch voltages with and without local equipotential bonding.

The treatment of touch voltage in TT systems is different to that explained for TN systems, but it is sufficient here to indicate that the touch voltage hand-to-hand in the equipotential zone created by the main bonding will be less in the former. But an installation in a TT system may be protected by only one RCD at the origin, so account has to be taken of the case where the person protected may be outside the equipotential zone.



## Index

- a.c. single-phase circuits
  - more rigorous method 135–40
  - short circuit conditions 127–40
- a.c. three-phase circuits, short circuit conditions 141–52
- ambient temperatures, low *see* low ambient temperatures
- buried in the ground circuits, cross-sectional areas of circuit live conductors 2, 14–18
- cable armouring as protective conductor, earth fault loop impedance 94–100
- cable sizes admixtures in enclosures, cross-sectional areas of circuit live conductors 33–8
- change of parameters of already installed circuits, cross-sectional areas of circuit live conductors 30–3
- combined examples 153–74
  - single-phase circuit, in flat two-core (with cpc) 70°C thermoplastic insulated and sheathed cable (not grouped) 154–6
  - single-phase circuit, in single-core 90°C thermosetting insulated cables having copper conductors, in trunking with five other similar circuits 156–8
  - single-phase circuit, in single-core non-armoured cables having 90°C thermosetting insulation and copper conductors, in conduit but not with the cables of other circuits 158–61
  - three-phase delta/star transformer, secondary voltage (on load) of 400 V between phases and 230 V phase-to-neutral 166–74
  - three-phase four-wire circuit, in multicore non-armoured 90°C thermosetting insulated cable (not grouped) 162–3
  - three-phase three-wire circuit, in multicore armoured 70°C thermoplastic insulated cable having copper conductors 163–6
- conductor operating temperature: accurate approach
  - earth fault loop impedance 75–80
  - voltage drop 43–55, 58–9
- conduit/trunking as protective conductor, earth fault loop impedance 87–93
- correction factors
  - cross-sectional areas of circuit live conductors 3–4, 24–6
  - low ambient temperatures 24–6
- cross-sectional areas of circuit live conductors 1–39
  - buried in the ground circuits 2, 14–18
  - cable sizes admixtures in enclosures 33–8
  - change of parameters of already installed circuits 30–3
  - correction factors 3–4, 24–6
  - current factors 3–4
  - design requirements 1–2
  - enclosed trenches 11–14
  - general circuits 4–5

- grouped circuits not liable to simultaneous overload 18–24
- grouped ring circuits 26–7
- grouping of cables having different insulation 39
- low ambient temperatures 24–6
- mineral-insulated cables 9–10
- motor circuits subject to frequent stopping and starting 27–9
- parameters changes of already installed circuits 30–3
- perforated metal cable trays 10–11
- requirements for calculation 1–2
- size admixtures of cables in enclosures 33–8
- star-delta starting of motors 29–30
- thermally insulating material 6
- thermally insulating walls 5–6
- trenches, enclosed 11–14
- trenches, ventilated 8–9
- varying external influences and installation conditions 6–8
- ventilated trenches 8–9
- cross-sectional areas of protective conductors 101–25
  - external cpc in parallel with the armour 111–13
  - fuses 104–10
  - mcb 113–19
  - residual current devices (RCDs) 119–25
- current factors, cross-sectional areas of circuit live conductors 3–4
- definitions xv–xix
- design requirements, cross-sectional areas of circuit live conductors 1–2
- duration curves, touch voltage duration curves 180–6
- earth fault loop impedance 65–100
  - accurate approach: conductor operating temperature 75–80
  - cable armouring as protective conductor 94–100
  - conductor operating temperature: accurate approach 75–80
  - conduit/trunking as protective conductor 87–93
  - protective conductors 87–100
  - reasons for calculating 65
  - simple approach 70–4
  - single-phase circuits 70–4
  - sub-distribution boards 82–7
  - three-phase circuits 72
  - transformer impedance 81–2
- ELV circuits *see* extra-low voltage circuits
- enclosed trenches, cross-sectional areas of circuit live conductors 11–14
- external cpc in parallel with the armour, cross-sectional areas of protective conductors 111–13
- extra-low voltage (ELV) circuits, voltage drop 62–4
- flat twin cable, touch voltage concept 177–8
- fuses
  - BS 88 ‘gG’ fuse, touch voltage concept 183
  - BS 3036 semi-enclosed fuse, touch voltage concept 183
  - cross-sectional areas of protective conductors 104–10
- general circuits, cross-sectional areas of circuit live conductors 4–5
- grouped circuits not liable to simultaneous overload, cross-sectional areas of circuit live conductors 18–24
- grouped ring circuits, cross-sectional areas of circuit live conductors 26–7
- grouping of cables having different insulation, cross-sectional areas of circuit live conductors 39
- IEC publication, touch voltage concept 180–1
- impedance characteristics, touch voltage concept 181–6
- insulation differences, cross-sectional areas of circuit live conductors 39

- live conductors, cross-sectional areas *see* cross-sectional areas of circuit live conductors
- load power factor: accurate approach, voltage drop 55–9
- local equipotential bonding, touch voltage concept 187
- low ambient temperatures
  - correction factors 24–6
  - cross-sectional areas of circuit live conductors 24–6
- mcb, cross-sectional areas of protective conductors 113–19
- mineral-insulated cables, cross-sectional areas of circuit live conductors 9–10
- motor circuits subject to frequent stopping and starting, cross-sectional areas of circuit live conductors 27–9
- parameters changes of already installed circuits, cross-sectional areas of circuit live conductors 30–3
- perforated metal cable trays, cross-sectional areas of circuit live conductors 10–11
- Prospective Touch Voltage, touch voltage concept 177
- protective conductors, earth fault loop impedance 87–100
- protective conductors, cross-sectional areas *see* cross-sectional areas of protective conductors
- RCBOs *see* residual current devices (RCDs)
- RCDs *see* residual current devices
- requirements for calculation, cross-sectional areas of circuit live conductors 1–2
- residual current devices (RCDs), cross-sectional areas of protective conductors 119–25
- ring circuits, voltage drop 59–62
- short circuit conditions 126–52
  - a.c. single-phase circuits 127–40
  - a.c. three-phase circuits 141–52
- single-phase circuit, in flat two-core (with cpc) 70°C thermoplastic insulated and sheathed cable (not grouped) 154–6
- single-phase circuit, in single-core 90°C thermosetting insulated cables having copper conductors, in trunking with five other similar circuits 156–8
- single-phase circuit, in single-core non-armoured cables having 90°C thermosetting insulation and copper conductors, in conduit but not with the cables of other circuits 158–61
- single-phase circuits
  - a.c. single-phase circuits, short circuit conditions 127–40
  - earth fault loop impedance 70–4
  - voltage drop 44–55
- size admixtures of cables in enclosures, cross-sectional areas of circuit live conductors 33–8
- star-delta starting of motors, cross-sectional areas of circuit live conductors 29–30
- sub-distribution boards, earth fault loop impedance 82–7
- supplementary bonding, touch voltage concept 185–7
- symbols xiii–xiv
- thermally insulating material, cross-sectional areas of circuit live conductors 6
- thermally insulating walls, cross-sectional areas of circuit live conductors 5–6
- three-phase circuits
  - a.c. three-phase circuits, short circuit conditions 141–52
  - earth fault loop impedance 72
  - voltage drop 45–55
- three-phase delta/star transformer, secondary voltage (on load) of 400 V between phases and 230 V phase-to-neutral 166–74
- three-phase four-wire circuit, in multicore non-armoured 90°C thermosetting insulated cable (not grouped) 162–3

- three-phase three-wire circuit, in multicore
  - armoured 70°C thermoplastic insulated cable having copper conductors 163–6
- TN-S system, touch voltage concept 175–7, 179–80
- touch voltage concept 175–87
  - BS 88 ‘gG’ fuse 183
  - BS 3036 semi-enclosed fuse 183
  - duration curves 180–6
  - flat twin cable 177–8
  - IEC publication 180–1
  - impedance characteristics 181–6
  - local equipotential bonding 187
  - Prospective Touch Voltage 177
  - supplementary bonding 185–7
  - TN-S system 175–7, 179–80
  - Type B mcb 184
- transformer impedance, earth fault loop impedance 81–2
- trenches *see* enclosed trenches; ventilated trenches
- varying external influences and installation conditions, cross-sectional areas of circuit live conductors 6–8
- ventilated trenches, cross-sectional areas of circuit live conductors 8–9
- voltage drop 40–64
  - accurate approach: conductor operating temperature 43–55, 58–9
  - accurate approach: load power factor 55–9
  - conductor operating temperature: accurate approach 43–55, 58–9
  - extra-low voltage (ELV) circuits 62–4
  - load power factor: accurate approach 55–9
  - normal load conditions 40–64
  - ring circuits 59–62
  - simple approach 40–3
  - single-phase circuits 44–55
  - three-phase circuits 45–55