

Quality Management in Construction Projects



Abdul Razzak Rumane



CRC Press
Taylor & Francis Group

Quality Management in Construction Projects

Industrial Innovation Series

Series Editor

Adedeji B. Badiru

*Department of Systems and Engineering Management
Air Force Institute of Technology (AFIT) – Dayton, Ohio*

PUBLISHED TITLES

Computational Economic Analysis for Engineering and Industry

Adedeji B. Badiru & Olufemi A. Omitaomu

Conveyors: Applications, Selection, and Integration

Patrick M. McGuire

Global Engineering: Design, Decision Making, and Communication

Carlos Acosta, V. Jorge Leon, Charles Conrad, and Cesar O. Malave

Handbook of Industrial and Systems Engineering

Adedeji B. Badiru

Handbook of Military Industrial Engineering

Adedeji B. Badiru & Marlin U. Thomas

Knowledge Discovery from Sensor Data

*Auroop R. Ganguly, João Gama, Olufemi A. Omitaomu, Mohamed Medhat Gaber,
and Ranga Raju Vatsavai*

Industrial Project Management: Concepts, Tools, and Techniques

Adedeji B. Badiru, Abidemi Badiru, and Adetokunboh Badiru

Inventory Management: Non-Classical Views

Mohamad Y. Jaber

**Moving from Project Management to Project Leadership: A Practical Guide
to Leading Groups**

R. Camper Bull

Quality Management in Construction Projects

Abdul Razzak Rumane

Social Responsibility: Failure Mode Effects and Analysis

Holly Alison Duckworth & Rosemond Ann Moore

STEP Project Management: Guide for Science, Technology, and Engineering Projects

Adedeji B. Badiru

Systems Thinking: Coping with 21st Century Problems

John Turner Boardman & Brian J. Sauser

Techonomics: The Theory of Industrial Evolution

H. Lee Martin

Triple C Model of Project Management: Communication, Cooperation, Coordination

Adedeji B. Badiru

FORTHCOMING TITLES

Essentials of Engineering Leadership and Innovation
Pamela McCauley-Bush & Lesia L. Crumpton-Young

Handbook of Industrial Engineering Calculations and Practice
Adedeji B. Badiru & Olufemi A. Omitaomu

Industrial Control Systems: Mathematical and Statistical Models and Techniques
Adedeji B. Badiru, Oye Ibidapo-Obe, & Babatunde J. Ayeni

Innovations of Kansei Engineering
Mitsuo Nagamachi & Anitawani Mohd Lokmanr

Kansei/Affective Engineering
Mitsuo Nagamachi

Kansei Engineering - 2 volume set
Mitsuo Nagamachi

Learning Curves: Theory, Models, and Applications
Mohamad Y. Jaber

Modern Construction: Productive and Lean Practices
Lincoln Harding Forbes

Project Management: Systems, Principles, and Applications
Adedeji B. Badiru

Research Project Management
Adedeji B. Badiru

Statistical Techniques for Project Control
Adedeji B. Badiru

Technology Transfer and Commercialization of Environmental Remediation Technology
Mark N. Goltz

Quality Management in Construction Projects

Abdul Razzak Rumane



CRC Press

Taylor & Francis Group

Boca Raton London New York

CRC Press is an imprint of the
Taylor & Francis Group, an **informa** business

CRC Press
Taylor & Francis Group
6000 Broken Sound Parkway NW, Suite 300
Boca Raton, FL 33487-2742

© 2011 by Taylor and Francis Group, LLC
CRC Press is an imprint of Taylor & Francis Group, an Informa business

No claim to original U.S. Government works

Printed in the United States of America on acid-free paper
10 9 8 7 6 5 4 3 2 1

International Standard Book Number-13: 978-1-4398-3872-3 (Ebook-PDF)

This book contains information obtained from authentic and highly regarded sources. Reasonable efforts have been made to publish reliable data and information, but the author and publisher cannot assume responsibility for the validity of all materials or the consequences of their use. The authors and publishers have attempted to trace the copyright holders of all material reproduced in this publication and apologize to copyright holders if permission to publish in this form has not been obtained. If any copyright material has not been acknowledged please write and let us know so we may rectify in any future reprint.

Except as permitted under U.S. Copyright Law, no part of this book may be reprinted, reproduced, transmitted, or utilized in any form by any electronic, mechanical, or other means, now known or hereafter invented, including photocopying, microfilming, and recording, or in any information storage or retrieval system, without written permission from the publishers.

For permission to photocopy or use material electronically from this work, please access www.copyright.com (<http://www.copyright.com/>) or contact the Copyright Clearance Center, Inc. (CCC), 222 Rosewood Drive, Danvers, MA 01923, 978-750-8400. CCC is a not-for-profit organization that provides licenses and registration for a variety of users. For organizations that have been granted a photocopy license by the CCC, a separate system of payment has been arranged.

Trademark Notice: Product or corporate names may be trademarks or registered trademarks, and are used only for identification and explanation without intent to infringe.

Visit the Taylor & Francis Web site at
<http://www.taylorandfrancis.com>

and the CRC Press Web site at
<http://www.crcpress.com>

Contents

Foreword	xv
Acknowledgments	xix
About the Author	xxi
Introduction	xxiii
Abbreviations	xxix
1 Overview of Quality	1
1.1 Quality History	1
1.2 Quality Definition	6
1.3 Quality Inspection	9
1.4 Quality Control	11
1.5 Quality Assurance	19
1.6 Quality Engineering	21
1.7 Quality Management	24
1.8 Quality Gurus	28
1.8.1 Philip B. Crosby	29
1.8.2 W. Edwards Deming	30
1.8.2.1 PDCA Cycle	30
1.8.2.2 Statistical Process Control	31
1.8.2.3 14 Principles for Transformation	32
1.8.2.4 The Seven-Point Action Plan	32
1.8.3 Armand V. Feigenbaum	32
1.8.4 Kaoru Ishikawa	33
1.8.5 Joseph M. Juran	40
1.8.6 John S. Oakland	42
1.8.7 Shigeo Shingo	42
1.8.8 Genichi Taguchi	44
1.8.9 Summary of Philosophies	44
1.9 Total Quality Management	48
1.9.1 Changing Views of Quality	48
1.9.2 Principles of Total Quality Management	51
1.10 Quality Function Deployment	57
1.11 Six Sigma	59
1.11.1 Introduction	59
1.11.2 Six Sigma Methodology	61
1.11.2.1 Leadership Principles	63
1.11.2.2 Six Sigma Team	64
1.11.3 Analytic Tool Sets	66
1.11.3.1 The DMAIC Process	68

1.11.4	Six Sigma in Construction Projects	72
1.11.4.1	The DMADV Process	72
1.12	TRIZ	78
1.12.1	TRIZ Methodology	78
1.12.2	Application of TRIZ	79
1.12.3	TRIZ Process	80
1.13	Quality in Use of CAD Software	80
1.13.1	Building Information Modeling	82
1.14	Value Methodology	83
1.14.1	Value	83
1.14.2	Value Engineering	85
1.14.2.1	Objective of Value Engineering	85
1.14.2.2	Value Engineering Team	85
1.14.2.3	Approach	86
1.14.2.4	Timings of Value Engineering	88
1.14.2.5	Stages of Value Engineering Study	93
1.14.2.6	Function Analysis System Technique (FAST)	95
1.14.2.7	The Benefits of Value Engineering	95
2	Integrated Quality Management	97
2.1	Introduction	97
2.2	Quality Standards	97
2.3	Standards Organizations	99
2.4	International Organization for Standardization (ISO)	102
2.5	ISO 9000 Quality Management System	107
2.5.1	Quality System Documentation	108
2.6	ISO Certification	109
2.7	ISO 14000 Environmental Management System	116
2.7.1	Benefits of ISO 14000	116
2.8	Occupational Health and Safety Assessment Series (OHSAS) 18000	116
2.8.1	Benefits of OHSAS Management System	117
2.9	Integrated Quality Management	117
3	Construction Projects	121
3.1	Project Definition	121
3.2	Construction Projects	122
3.3	Construction and Manufacturing	126
3.4	Quality Cost	129
3.4.1	Introduction	129
3.4.2	Categories of Costs	129
3.4.3	Reasons for Poor Quality	131
3.4.4	Quality Cost in Construction	134
3.4.5	Quality Performance Management System	137

3.5	Systems Engineering	138
3.5.1	Introduction	138
3.5.2	System Definition.....	139
3.5.3	Systems Engineering	140
3.6	Construction Project Life Cycle	141
4	Quality in Construction Projects	149
4.1	Quality in Construction Projects	149
4.1.1	Design/Bid/Build	160
4.1.2	Design/Build	161
4.1.3	Project Manager	162
4.1.4	Construction Manager	162
4.1.5	Guaranteed Maximum Price	163
4.1.6	Build–Own–Operate–Transfer.....	165
4.1.7	The Turnkey Contract	165
4.2	Conceptual Design.....	168
4.2.1	Identification of Need.....	169
4.2.2	Feasibility	170
4.2.3	Identification of Project Team	172
4.2.4	Identification of Alternatives.....	174
4.2.5	Financial Implications/Resources	175
4.2.6	Time Schedule	179
4.2.7	Development of Concept Design.....	179
4.3	Preliminary Design	183
4.3.1	General Scope of Works/Basic Design	184
4.3.2	Regulatory Approval.....	185
4.3.3	Budget.....	185
4.3.4	Schedule	185
4.3.5	Contract Terms and Conditions.....	186
4.3.6	Value Engineering Study	186
4.4	Detailed Design.....	186
4.4.1	Detail Design of the Works	187
4.4.1.1	Architectural Design	189
4.4.1.2	Concrete Structure	191
4.4.1.3	Elevator Works.....	192
4.4.1.4	HVAC Works.....	193
4.4.1.5	Fire Protection System	194
4.4.1.6	Plumbing Works.....	194
4.4.1.7	Drainage System.....	194
4.4.1.8	Electrical System.....	195
4.4.1.9	Fire Alarm System.....	196
4.4.1.10	Telephone/Communication System	196
4.4.1.11	Public Address System	196
4.4.1.12	Audiovisual System	197
4.4.1.13	Security System/CCTV	197

	4.4.1.14 Security System Access Control.....	198
	4.4.1.15 Landscape.....	198
	4.4.1.16 External Works (Infrastructure and Road).....	199
	4.4.1.17 Bridges	200
	4.4.1.18 Highways.....	201
	4.4.1.19 Furnishings/Furniture (Loose).....	202
	4.4.2 Regulatory/Authorities' Approval	207
	4.4.3 Contract Documents and Specifications.....	207
	4.4.4 Detail Plan.....	215
	4.4.5 Budget.....	217
	4.4.6 Cash Flow.....	217
	4.4.7 Tender/Bidding	218
4.5	Construction	222
	4.5.1 Mobilization.....	225
	4.5.2 Execution of Works.....	226
	4.5.3 Planning and Scheduling.....	230
	4.5.4 Management Resources/Procurement	241
	4.5.5 Monitoring and Control.....	247
	4.5.5.1 Subcontractors Submittal and Approval Log.....	252
	4.5.5.2 Shop Drawings and Materials Logs—E1	253
	4.5.5.3 Procurement Log—E2	256
	4.5.5.4 Equipment and Manpower Logs	256
	4.5.5.5 Project Payment/Progress Curve (S-Curve).....	257
	4.5.5.6 Time Control	258
	4.5.5.7 Cash and Time Control.....	258
	4.5.5.8 Progress Reports and Meetings	258
	4.5.5.9 Variation Orders	266
	4.5.6 Quality Control	274
	4.5.6.1 Shop Drawings Approval	278
	4.5.6.2 Materials Approval	288
	4.5.6.3 Contractor's Quality Control Plan	305
	4.5.6.4 Site Safety	318
	4.5.6.5 5S for Construction Projects	323
	4.5.7 Inspection.....	324
4.6	Testing, Commissioning, and Handover.....	326
	4.6.1 Testing	326
	4.6.2 Commissioning.....	330
	4.6.3 Authorities' Approval	330
	4.6.4 As-Built Drawings	330
	4.6.5 Technical Manuals and Documents.....	331
	4.6.6 Training of User's Personnel	332
	4.6.7 Handover of Facility to Owner/End User.....	332
	4.6.8 Move-In Plan	333
	4.6.9 Substantial Completion.....	335

5	Operation and Maintenance.....	339
5.1	Operation and Maintenance.....	339
5.2	Categories of Maintenance	339
5.2.1	Preventive Maintenance	340
5.2.2	Scheduled Maintenance.....	340
5.2.3	Breakdown Maintenance.....	340
5.2.4	Routine Maintenance	340
5.2.5	Replacement of Obsolete Items	340
5.2.6	Predictive Testing and Inspection.....	340
5.3	O&M Program.....	341
6	Facility Management.....	347
6.1	Facility Management	347
6.2	Facility Management Outsourcing.....	350
6.3	Computer-Aided Facility Management (CAFM).....	352
6.4	Benefits of FM.....	352
6.5	Quality Requirements of FM.....	354
7	Assessment of Quality.....	357
7.1	Introduction	357
7.2	Assessment Categories.....	357
7.2.1	Cost of Poor Quality	357
7.2.2	Organization’s Standing in the Marketplace.....	358
7.2.3	Quality Cultures in the Organization	358
7.2.4	Operation of Quality Management System	361
7.3	Self-Assessment.....	362
	Appendix A: Design Review Checklists	365
	Appendix B: Major Activities in Building Construction Projects.....	381
	Appendix C: Content of Contractor’s Quality Control Plan.....	391
	Bibliography.....	415
	Index	417

Foreword

My first awareness of Abdul Razzak Rumane came from simply viewing his name on a list several years ago. As chancellor of Kennedy-Western University, it was my pleasant task to select a student commencement speaker, and at that time, Mr. Rumane was on schedule to graduate. Since his academic department was an area completely separate from mine, I had not encountered him before as a student. I was impressed, however—even sight unseen—to know that he had completed the requirements for his doctoral degree.

The university had a well-established history of providing a quality education to midcareer professionals, and that was long before the Internet became a reality. Of course, the technology, as it was developed and refined, became more and more beneficial. Even so, it takes a special sort of person to undertake, let alone complete, a degree program, especially a *graduate* degree program at the level of a Ph.D. via distance learning. Suffice it to say, I sensed a positive regard for Mr. Rumane long before I met the man.

When commencement day arrived, I made it a point before the ceremony to greet each of the graduates, provide some brief instructions, and try to allay any anxiety they might have. After all, they had come together as classmates of an unusual sort—long-distance colleagues who had never actually met each other—from all across the United States and beyond. Some brought partners, parents, children, and others to celebrate the achievement of their common goal, but they all came to celebrate.

It was heartwarming to see them congratulate each other. They all knew very well the kinds of sacrifices that resulted in each one's presence on that auspicious occasion.

With the limited time we had together, and continuing through a lovely reception following all of the pomp and circumstance, my initial impression of all those students was definitely confirmed. Mr. Rumane, especially, struck me as a man of hard work and determination, as well as one whose passion and compassion were evident. He was one who would go further still along the path he had started; he would be one who really tried to make a difference.

During the commencement, I was charged with the responsibilities of conducting the ceremony, addressing the graduates, hooding those receiving advanced degrees, and conferring the degrees at the bachelor's, master's, and doctoral levels. One bit of wisdom I always tried to impart to the students was the concept of balancing justifiable pride in their accomplishments with humility and gratefulness for the opportunity that was theirs.

My challenge to each group of graduates was always to use their education as a vehicle for service. I told them if ever they were tempted to use it as a weapon to demean or intimidate another person, they might very well be missing the point.

On that graduation day, Mr. Rumane became Dr. Rumane. Since that time he has evolved even further toward his dream, and it appears he has taken my advice to heart. As an expert in quality assurance processes, particularly as they apply to the construction industry, Dr. Rumane has become a gatekeeper.

I use the term “gatekeeper” deliberately, because it represents the same standard to which I hold myself as an educator. And now, as a university department chair, I expect my faculty as well to function at that level.

Esteemed educational and healthcare administration philosopher Patrick M. Vance once stated (with regard to working with students in general): “They’re doing what they *have* to do to get by. What *we* have to do is make it so they *can’t* get by without doing some worthwhile things.”

As we work through the processes of education and career, and to some extent life itself, each step of the way there are individuals whose job it is to determine whether we have done what was necessary—make the grade, accomplish the objectives, meet the standards, fulfill the commitments—to merit moving forward. They are the gatekeepers, the ones whose responsibility it is to determine the extent to which we have done those worthwhile things. Although we might sometimes dread what the gatekeepers have to say, we are always proud when we know we have satisfactorily completed what was required to earn our “promotion” to the next level.

In this book, Dr. Rumane makes connections that should be of emergent concern to everyone. Even though his focus on the surface might seem fairly limited, consider the concept of quality assurance in the construction industry from a larger perspective. There appears to be an ongoing tendency for Americans to take for granted the quality of our societal infrastructure, yet how often do we encounter graphic evidence that contradicts our pervasive, perhaps even arrogant, assumption that U.S. products and services are safe and effective?

The media far too frequently report on the devastation of buildings or other structures buckling under the stress of a heavy blanket of snow or twisting in the intense power of an unusual windstorm. The past few years have been replete with examples.

Who among us can deny the helplessness and horror of watching the Twin Towers of the World Trade Center collapse as a result of the intense heat generated by the terrorist attack of September 11 in 2001?

Even now, is it not almost inconceivable that a natural disaster of the magnitude of Hurricane Katrina could destroy so much of one of America’s great cities?

Have not the integrity and safety of freeway bridges and overpasses legitimately come under more intense scrutiny since the collapse of the I-35 span in Minneapolis in 2007?

Although some disasters are inevitable or unavoidable, some truly are. Our best hope for creating and maintaining the highest quality possible,

therefore ensuring the highest possible degree of safety and reliability, is for those who plan and supervise construction to take seriously and apply the concepts promoted by gatekeepers such as Dr. Rumane. And so, here's to them!

Ted Coleman, Ph.D., CHES

*Professor and Department Chair, Health Science and Human Ecology
California State University, San Bernardino
Former Chancellor, Kennedy-Western University*

Acknowledgments

Share the knowledge with others is the motto of this book.

Many colleagues and friends extended help by arranging reference material while I was preparing this book. Many thanks to all of them for their support.

I thank the publishers and authors whose writings are included in this book for extending their support by allowing me to reprint their material.

I thank the reviewers from various professional organizations for their valuable input to improve my writing. I thank members of ASQ Design & Construction Division, The Institution of Engineers (India) and the Kuwait Society of Engineers for their support to bring out this book.

I thank Series Editor Dr. Adedeji B. Badiru and Senior Acquisitions Editor Cindy Renee Carelli of CRC Press and other staff for their support and contribution to make this construction-related book a reality.

I thank Raymond R. Crawford of Parsons Binckerhoff for his valuable and timely suggestions during my writing. I thank Dr. N. N. Murthy of Jagruti Kiran Consultants for his support.

Most of the data discussed in this book are from the author's practical and professional experience and are accurate to the best of the author's knowledge and ability. However, if any discrepancies are observed in the presentation, I would appreciate having them communicated to me.

I extend my thanks to Dr. Ted Coleman for his thoughtful foreword.

I thank my well-wishers who inspired me to complete this book.

The contributions of my son Atallah, my daughter Farzeen, and daughter-in-law Ferha are worth mentioning here. They encouraged me and helped me in my preparatory work to achieve the final product. I thank my parents and other family members for their support and encouragement during the writing.

Finally, I thank my wife, Noor Jehan, for her patience as she had to suffer a lot because of my busy schedule.

About the Author



Abdul Razzak Rumane Ph.D., is a certified consultant engineer in electrical engineering. He obtained a Bachelor of Engineering (electrical) degree from Marathwada University (now Dr. Babasaheb Ambedkar Marathwada University, India) in 1972, and received his Ph.D. from Kennedy-Western University (now Warren National University) in 2005. His dissertation topic was "Quality Engineering Applications in Construction Projects." Dr. Rumane's professional career exceeds 37 years, including 10 years in manufacturing industries and about 27 years in construction projects.

Presently he is employed with SSH International Engineering Consultants, an A&E firm in Kuwait.

Dr. Rumane is associated with a number of professional organizations. He is a fellow of The Institution of Engineers (India) and has an honorary fellowship from the Chartered Management Association (Hong Kong). He is also a senior member of the Institute of Electrical and Electronics Engineers (U.S.A.), a senior member of the American Society for Quality, a member of the Kuwait Society of Engineers, a member of SAVE International (The Value Society), and is a certified AVS (Associate Value Specialist) member of the Project Management Institute. He is also an associate member of the American Society of Civil Engineers, a member of the London Diplomatic Academy, and a member of the Board of Governors of the International Benevolent Research Forum.

As an accomplished engineer, Dr. Rumane has been awarded an honorary doctorate in engineering from Yorker International University. The Albert Schweitzer International Foundation honored him with its gold medal for "outstanding contribution in the field of electrical engineering/consultancy in construction projects in Kuwait"; the European Academy of Informatisation awarded him the "International World Order of Science-Education-Culture" and the title of "Cavalier," and the Sovereign Order of the Knights of Justice in England honored him with its Meritorious Service Medal. He was selected as one of the Top 100 Engineers of IBC (International Biographical Centre, Cambridge U.K.) in 2009. He was also the honorary chairman of the Institute of Engineers (India), Kuwait Chapter, from 2005 to 2007.

Introduction

Quality is a universal phenomenon that has been a matter of great concern throughout recorded history. It was always the determination of builders and makers of products to ensure that their products meet the customer's desire.

With the advent of globalization and the competitive market, the emphasis on quality management has increased. Quality has become the most important single factor for the survival and success of today's companies. Customer demands for better products and services at the lowest possible costs have put tremendous pressure on firms to improve the quality of products, services, and processes to compete in the market and improve business results. It became important that construction projects be more qualitative, competitive, and economical to meet owner's expectations.

Construction projects have the involvement of many participants including the owner, designer, contractor, and many other professionals from construction-related industries. Each of these participants is involved in implementing quality in construction projects. These participants are both influenced by and depend on each other in addition to "other players" involved in the construction process. Therefore, the construction projects have become more complex and technical, and extensive efforts are required to reduce rework and costs associated with time, materials, and engineering.

This book has been developed to provide significant information on quality issues to professional practitioners involved in construction projects (mainly civil construction projects and commercial/A&E projects) and construction-related industries, stressing the importance of quality, various quality control principles, procedures, concepts, methods, and tools and their applications to various activities/components/subsystems at different phases in the life cycle of a construction project to improve construction processes to conveniently manage projects and make them more qualitative, competitive, and economical. The book contains useful materials and information for students interested in acquiring knowledge about quality in the fields of construction projects, quality engineering, construction management, and project management. The book will also provide specific information to academics about the practices followed in construction projects.

The data discussed and derived in the book is from the author's practical and professional experience in the construction field focusing on quality during the design and construction process. It also includes the reference writings of well-known quality "philosophers" whose work has dominated the quality movement. Their ideas and approaches to address specific quality issues have become part of accepted wisdom in the quality field. The book contains many tables and figures to support the author's writings and

to make understanding of the subject easy. Different types of forms and transmittals used to plan, monitor, and control the project at different stages are included for the benefit of readers.

Quality has been of great concern throughout the recorded history of human beings. Examples of specification and inspection can be found in the Bible dating back to at least 500 BCE. The desire for products that do as well or better than the customer's needs and requirements has always been a constant in human history, matched only by the determination of builders and makers to meet that desire.

Quality control was primarily carried out by inspection of goods before sale. Growth of commerce and science and technology greatly expanded the extent and variety of nonnatural goods and services. With the advent of the Industrial Revolution, the situation changed dramatically. This period in history marked the beginning of quality control through inclusion of process in quality practices. The practices began to be employed consistently to meet higher standards. Quality concepts moved through different stages such as inspection, quality control, quality assurance, and total quality to reach the quality concept called Total Quality Management (TQM). The value analysis concept started in the mid-1940s and also was applied in construction projects to improve the value of the project. Introduction of Six Sigma by Motorola in 1987 improved business results, and TRIZ methodology is used for generating innovative ideas for problem resolution, resulting in low-cost quality improvement solutions. Continuous improvement in quality tools, techniques, and philosophies of quality management is taking place on a regular basis. Quality concepts, principles, methods, and processes, along with quality systems, environmental systems, and health and safety provisions, are integrated to create a new quality concept known as the Integrated Quality Management System.

As product quality requirements rose, producers acquired greater skills in technical quality disciplines geared to technology and the product. Further, there was pressure to reduce the price to the consumer, and because of these economics, work became more competitive. Quality took a major step forward with the move from inspection to the concept of conformity to standards. Automation led to greater standardization. For a number of years, the standards-based quality culture and the new concepts of continuous improvements, customer focus, and process control evolved. Thus, the quality concept started shifting from inspection to standardization and standardization to quality management.

The beginning of the 20th century marked inclusion of process in quality practices. Inspection and quality control teams assumed greater importance in production. Shewhart introduced the concept of statistical quality control (SQC) to quality problems. Quality control in this form was the norm in manufacturing until the early 1960s. Different types of control charts are being used for problem solving and continuous improvement of quality. This was followed by the concept of quality assurance.

Quality is a distinguishing characteristic of products or services, which satisfy the customer. Most production or services systems are of a repetitive nature and are designed for mass production or batch (lot) production. The definition of quality for construction project is different from that of manufacturing or services industries. In the case of mass production and batch-oriented production systems, quality can be achieved by getting feedback from the process by observing the actual performance and regulating the process to meet the established standards. Whereas, because of the nonrepetitive nature of construction projects, it is not possible to compare actual performance of the project as past experience may be of limited value. The quality management of manufactured products is performed by the manufacturer's own team, which has control over all the activities of the product life cycle, whereas construction projects have a diversity of interactions and relationships between owners, architects/engineers, and contractors. Construction projects differ from manufacturing or production. Construction projects are custom oriented and custom designed, having specific requirements set by the customer/owner to be completed within a finite duration and assigned budget. Every project has elements that are unique. No two projects are alike. It is always the owner's desire that his project be unique and better. To a great extent, each project has to be designed and built to serve a specified need. Construction projects are more customized than a routine and repetitive business.

Research in the construction industry has proved that utilization of quality management concepts has a great influence on the cost-effectiveness results of construction projects and achieving successful project performance. This can be brought about by applying various quality procedures and principles at different phases and stages of construction projects to conveniently manage the projects through each activity and improve the control and planning of the construction project.

For the sake of proper understanding, the book is divided into seven chapters, and each chapter is divided into number of sections covering quality-related topics that have importance or relevance for understanding quality concepts for construction projects.

Chapter 1 is an overview of quality and is focused on the historical importance and background of quality. Quality has moved into different forms through distinct phases under an array of names such as inspection, statistical quality control, quality assurance, and strategic quality management, leading to the concept of quality being known as Total Quality Management (TQM). Periodical changes in the quality system and cultural changes needed in various areas to meet TQM are also discussed. This part includes principles and basic components of TQM. Brief descriptions of various quality control tools with representative figures are to be found in this chapter to illustrate their applications in practical usage. Quality function deployment is discussed to show how it can be applied by construction project design professionals. An introduction to Six Sigma and its analytic tools, preparing

a contractor's construction schedule using DMADV, and a brief introduction to TRIZ are also discussed. Factors related to quality in the use of computer-aided design (CAD) software are reviewed here. There are prominent researchers and practitioners, known as "quality gurus," whose works have dominated the quality movement. This chapter elaborates on the contribution of their philosophies, methods, and approaches in addressing specific quality issues. Value engineering–related basic topics such as the objectives of value engineering, timing of value engineering, and the benefits of value engineering are outlined.

Chapter 2 is about Integrated Quality Management. This chapter covers a brief introduction to standards and standardization bodies, the ISO certification process, quality system documentation and how an Integrated Quality Management System can be used to develop the contractor's Quality Control Plan.

Chapter 3 is about construction projects. Project definition, types of construction projects, and comparisons between construction and manufacturing are discussed. This part covers cost of quality, categories of costs, reasons for poor quality, and brief information about the quality performance management system. A definition of systems engineering, its principles and applications, and an approach to construction projects are reviewed. This part also includes a chapter on the construction project life cycle, which is developed based on systems engineering principles, and details how construction projects can be divided into the five most common phases (conceptual design; preliminary design; detailed design; construction; and testing, commissioning, and handover) and further subdivided into various elements/activities/subsystems with a functional relationship to conveniently manage the construction projects.

Chapter 4 details quality in construction projects and discusses various concepts of quality, principles, methods, tools, and processes that can be applied to all the phases of a construction project right from the inception of the project until the issuance of a substantial completion certificate and handover of project. Brief information about different types of contract deliverable systems, contract documents, and contract types based on the form of payment is also discussed in this part. This part discusses the owner's role while defining the project and terms of reference (TOR). This chapter includes information regarding the designer's role and responsibilities to prepare design drawings and documents by properly specifying important parameters and features of the required services/systems. (Design review checklists are included in Appendix A.) This chapter also elaborates on different procedures the contractor has to follow during the construction process. This chapter also includes guidelines to contractors about preparation and submission of construction programs, logs, product data, and shop drawings. Various procedures and principles followed during the construction phase are discussed and implemented. These include mobilization, execution, planning, scheduling, monitoring, control, quality, and testing to

achieve the desired quality results for the project. A summary of probable reasons for rejection of work executed by the contractor is presented in a tabular form.

Chapter 5 is on operation and maintenance, which covers brief information of posthandover activities such as operation and maintenance.

Chapter 6 is about facility management and Chapter 7 relates to assessment of quality.

The importance of a work breakdown structure is discussed and a list of major activities used in preparation of a contractor's construction program is included as Appendix B. General requirements to prepare a contractor's quality control plan and an example contractor's quality control plan are included as Appendix C. Brief information about site safety and 5S for construction projects is also discussed here.

The book, I am certain, will meet the requirements of construction professionals, students, and academics, and satisfy their needs.

Abbreviations

AAMA: American Architectural Manufacturers Association
ACI: American Concrete Institute
ACMA: American Composites Manufacturers Association
AISC: American Institute of Steel Construction
ANSI: American National Standards Institute
API: American Petroleum Institute
ARI: American Refrigeration Institute
ASCE: American Society of Civil Engineers
ASHRAE: American Society of Heating, Refrigerating and Air-Conditioning Engineers
ASQ: American Society for Quality
ASTM: American Society for Testing and Materials
BMS: Building Management System
BREEAM: Building Research Establishment Environmental Assessment Method
BSI: British Standards Institution
CEN: Comité Européen de Normalization (European Committee for Standardization); European Committee for Standardization
CIBSE: Chartered Institution of Building Services Engineers
CIE: Commission International d'Éclairage (International Commission on Illumination)
CII: Construction Industry Institute
CSC: Construction Specifications, Canada
CSI: Construction Specifications Institute
CTI: Cooling Tower Institute
DIN: Deutsches Institut für Normung
EIA: Electronic Industries Alliance
EN: European Norms
FIDIC: Fédération International des Ingénieurs-Conseils
HQE: Higher Quality Environmental
ICE: Institution of Civil Engineers (UK)
IEC: International Electrotechnical Commission
IEEE: Institute of Electrical and Electronics Engineers
IP: Ingress Protection
ISO: International Organization for Standardization
LEED: Leadership in Energy and Environmental Design
NEC: National Electrical Code
NEMA: National Electrical Manufacturers Association (USA)
NFPA: National Fire Protection Association

NWWDA: National Wood Window and Door Association

PMBOK: Project Management Book of Knowledge

PMI: Project Management Institute

QS: Quantity Surveyor

RFID: Radio Frequency Identification

SDI: Steel Door Institute

TIA: Telecommunications Industry Association

UL: Underwriters Laboratories

1

Overview of Quality

1.1 Quality History

Quality issues have been of great concern throughout the recorded history of humans. During the New Stone Age, several civilizations emerged, and some 4000–5000 ago, considerable skills in construction were acquired. The pyramids in Egypt were built approximately 2589–2566 BCE. Hammurabi, the king of Babylonia (1792–1750) BCE codified the law, according to which, during the Mesopotamian era, builders were responsible for maintaining the quality of buildings and were given the death penalty if any of their construction collapsed and their occupants were killed. The extension of Greek settlements around the Mediterranean after 200 BCE left records showing that temples and theaters were built using marble. India had strict standards for working in gold in the fourth century BCE.

According to *A History of Managing for Quality* (J. M. Juran, editor-in-chief) China's recorded quality history can be traced back to earlier than 200 BCE. China had instituted quality control in its handicrafts during the Zhou dynasty between 1100 and 250 BCE. During this period, the handicraft industry was mainly engaged in producing ceremonial artifacts. Table 1.1 presents a sample of surviving writings that are related to quality management in China during ancient days. This industry survived the long succession of dynasties that followed up to 1911 CE.

Scandinavian shipbuilders were using quality improvement techniques over the whole first two millennia BCE and the first millennium CE. Examples of specification and inspection can be found in the Bible dating from at least 500 BCE and, at about the same time, the Greeks were using tight quality control methods in the building of their temples. The Romans standardized nearly everything they touched from 300 BCE to 300 CE. According to Sebestyeny (1998), "Marcus Vitruvius Pollo, the first century BCE military and civil engineer, published his 10 books (i.e., a book with 10 chapters) in Rome. This was the world's first major publication on architecture and construction, and it dealt with building materials, the style and design of building types, the construction process, building physics, astronomy and building machines" (p. 2).

TABLE 1.1

A Sample of Ancient Chinese Writings on Quality Management

<i>Kao Gong Ji</i> (Records in inspecting the works)	403 BCE	A recognition of quality as the combined result of “the time of heaven, the energy of earth, the beauty of material, and the skill of the workman”
<i>Tang Lu Shu Yi Za Lu Men</i> (Introduction to the laws of the Tang dynasty, miscellaneous categories)	Complied in 635–640 CE	A law stipulating that measuring tools were to be checked every August and were to be used only after the seals were affixed
<i>Wu Jing Zong Yao</i> (Compendium of the most important military techniques)	650–950 CE	Subject: weapons manufacture
<i>Ying Zao Yi Xun</i> (Architecture rules and methods)	Song dynasty (960–1219 CE)	Subject: architecture
<i>Zi Re Yi Xun</i> (Teachings of the deceased)	Yuan dynasty (1279–1368 CE)	Subject: textiles
<i>Long Jiang Chuan Chang Zhi</i> (Records of the Long Jiang shipyard)	Ming dynasty (1368–1644 CE)	Subject: shipbuilding
<i>Cong Cheng Zuo Fa Gui Ze</i> (Regulations in engineering projects)	Qing dynasty (1644–1911 CE)	Subject: construction
<i>Tian Gong Kai Wu</i> (Technology and manufacture)	1637 CE by Sung Yingxing	Subject: manufacturing

Source: Juran, J.M., and Godfrey, A.B. *Juran's Quality Handbook*. Reprinted with permission from The McGraw-Hill Companies.

During the Middle Ages, guilds took the responsibility for quality control upon themselves. Guilds and governments carried out quality control; consumers, of course, carried out informal quality inspection throughout history.

The guilds' involvement in quality was extensive. All craftsmen living in a particular area were required to join the corresponding guild and were responsible for controlling the quality of their own products. If any of the items was found defective, then the craftsman discarded the faulty items. The guilds also initiated punishments for members who turned out shoddy products. They maintained inspections and audits to ensure that artisans followed quality specifications. The guild hierarchy consisted of three categories of workers: apprentice, journeyman, and master. The guilds had established specifications for input materials, manufacturing processes, and finished products, as well as methods of inspection and testing. They were active in managing quality during middle ages until the Industrial Revolution marginalized their influence.

The Industrial Revolution began in Europe in the mid-19th century. It gave birth to factories, and the goals of the factories were to increase productivity and reduce costs. Prior to the Industrial Revolution, items were produced

by individual craftsman for individual customers, and it was possible for workers to control the quality of their products. Working conditions then were more conducive to professional pride. Under the factory system, the tasks needed to produce a product were divided among several or many factory workers. Under this system, large groups of workmen were performing similar types of work, and each group was working under the supervision of a foreman who also took on the responsibility of controlling the quality of the work performed. Quality in the factory system was ensured by means of skilled workers, and the quality audit was done by inspectors.

The broad economic result of the factory system was mass production at low costs. The Industrial Revolution changed the situation dramatically with the introduction of a new approach to manufacturing.

In the early 19th century, the approach to manufacturing in the United States tended to follow the craftsmanship model used in European countries. In the late 19th century, Fredrick Taylor's system of "Scientific Management" was born. Taylor's goal was to increase production. He achieved this by assigning planning to specialized engineers, and execution of the job was left to supervisors and workers. Taylor's emphasis to increase production had a negative effect on quality. With this change in the production method, inspection of finished goods became the norm rather than inspection at every stage. To remedy the decline in quality, factory managers created inspection departments having their own functional bosses. These departments were known as quality control departments.

The beginning of the 20th century marked the inclusion of process in quality practices. During World War I, the manufacturing process became more complex. Production quality was the responsibility of quality control departments. The introduction of mass production and piecework created quality problems as workmen were interested in earning more money by the production of extra products, which in turn led to bad workmanship. This situation made factories introduce full-time quality inspectors, which marked the real beginning of inspection quality control and thus the introduction of quality control departments headed by superintendents. Walter Shewhart introduced statistical quality control in the process. His concept was that quality is not relevant to the finished product but to the process that created the product. His approach to quality was based on continuous monitoring of process variation. The statistical quality control concept freed manufacturers from the time-consuming 100% quality control system because it accepted that variation is tolerable up to certain control limits. Thus, the quality control focus shifted from the end of line to the process.

The systematic approach to quality in industrial manufacturing started during the 1930s when some attention was given to the cost of scrap and rework. With the impact of mass production, which was required during World War II, it became necessary to introduce a more stringent form of quality control. This was instituted by manufacturing units and was identified as Statistical Quality Control (SQC). SQC made a significant contribution in that it provided a

sampling rather than 100% product inspection. However, SQC was instrumental in exposing the underappreciation of the engineering of product quality.

In his books, Juran (Juran and Godfrey 1999) has detailed that, prior to World War II, Japanese research on and applications of modern quality control were limited. Japanese product quality was poor relative to international levels. These poor products were sold only at ridiculously low prices, and it was difficult to secure repeat sales. Among the exceptions were the high-technology products of some Japanese companies, primarily for military use, which were manufactured without the successful application of mass production techniques.

The concepts and techniques of modern quality control were introduced in Japan from the United States immediately after World War II. The General Headquarters (GHQ) of the allied occupation forces in Japan was experiencing difficulties with the poor state of the country's communication systems and the defective quality and late delivery of communication equipment and components ordered from Japanese manufacturers. The GHQ's Civil Communication Section (CSS) was instructed to provide communication equipment manufacturers with business management guidance, including advice on quality control. Many Japanese manufacturing companies received help from the members of the section. (Juran, 1999, p. 41.2)

Juran further states:

In Europe quality was considered as a cultural issue first and a technical issue second. In western Europe as in other areas of the Western world, from the 1950's to the 1970's, quality was considered a priority issue mainly in defense aerospace, telecommunications, electro-nuclear energy and energy in general, chemicals and their high technology sectors. An indication of the level of interest in quality disciplines (specifically, in statistical quality control) was the formation of national quality associations in many European countries during the early 1950s. In the area of consumer durables and consumer goods in general, which were enjoying a period of high demand, a capacity for innovation and the ability to produce large volumes at low cost were the main priorities. Healthy market performance meant staying more or less in line with the typical (and often mediocre) quality standards of the relevant price/performance class, which, given the lack of specific competitive estimate, tended to remain stable. Certain niches, brands or even entire geographical areas stood out for high quality and reliability of their products, but as a rule, higher quality positioned a product in a higher price class compared with products offering similar performance. Countries like Germany, for instance, had a reputation for superior product quality, especially in niche markets (e.g., luxury automobiles, electric home appliances), but since this quality stemmed from the high professional skills and craftsmanship, product prices were usually higher. (p. 38.2)

Harold Kerzner (2001) has given the quality history of the past 100 years:

During the past 100 years the views of quality have changed dramatically. Prior to World War I, quality was viewed predominantly as inspection, sorting out the good items from the bad. Emphasis was on problem identification. Following World War I and up to the early 1950s, emphasis

was still on sorting good items from bad. However, quality control principles were now emerging in the form of

- Statistical and mathematical techniques.
- Sampling tables.
- Process control charts.

He further states that, from the early 1950s to the late 1960s, quality control evolved into quality assurance, with its emphasis on problem avoidance rather than problem detection. Additional quality assurance principles emerged, such as

- The cost of quality
- Zero-defect programs
- Reliability engineering
- Total quality control

Kerzner (2001) has gone further, saying that

Today, emphasis is being placed on strategic quality management, including such topics as

- Quality is defined by the customer.
- Quality is linked with profitability on both the market and cost sides.
- Quality has become a competitive weapon.
- Quality is now an integral part of the strategic planning process.
- Quality requires an organization wide commitment. (p. 1087)

Thomas Pyzdek (1999) has stated that, in the last century, quality has moved through four distinct “quality eras”: inspection, statistical quality control, quality assurance, and strategic quality management. A fifth era is emerging—complete integration of quality into the overall business system. Managers in each era were responding to the problems they faced at the time (p. 12).

From the foregoing writings and many others on the history of quality, it is evident that the quality system in its different forms has moved through distinct quality eras such as

1. Quality inspection
2. Quality control
3. Quality assurance
4. Total quality

However, quality actually emerged as a dominant thinking only since World War II, becoming an integral part of overall business system focused on

The International Organization for Standardization (ISO, 1994a) defines quality as “the totality of characteristics of an entity that bears on its ability to satisfy stated or implied needs.”

Pyzdek (1999) views that there is no single generally accepted definition of quality. He has quoted five principal approaches to defining quality that have been described by Garvin (1988). These are as follows:

1. *Transcendent*—“Quantity cannot be defined, you know what it is.” (Persig 1974, p. 213)
2. *Product-based*—“Differences in quality amount to differences in the quantity of some desired ingredient or attribute.” (Abbott 1955, pp. 126–127)
 “Quality refers to the amounts of the unpriced attributes contained in each unit of the priced attribute.” (Leflore 1982, p. 952)
3. *User-based*—“Quality consists of the ability to satisfy wants.” (Edwards 1968, p. 37)
 “In the final analysis of the market place, the quality of a product depends on how well it fits patterns of consumer preference.” (Kuehn and Day 1954, p. 831).
 “Quality is fitness for use.” (Juran 1974, p. 2-2)
4. *Manufacturing-based*—“Quality (means) conformance to requirements.” (Crosby 1979, p. 15)
 “Quality is the degree to which a specific product conforms to a design or specification.” (Gilmore 1974, p. 16)
5. *Value-based*—“Quality is the degree of excellence at an acceptable price and the control of variability at an acceptable cost.” (Broh 1982, p. 3)
 “Quality means best ‘for certain customer conditions.’ These conditions are (a) the actual use, and (b) the selling price of the product.” (Feigenbaum 1991, pp. 1, 25)

The above definitions can further be summarized under the name of those contributors to the quality movement whose philosophies, methods, and tools have been proved useful in quality practices. They are called the “quality gurus.” Their definitions are of quality are

1. *Philip B. Crosby*—Conformance to requirements not as “goodness” nor “elegance.”
2. *W. Edward Deming*—Quality should be designed into both product and the process.
3. *Armand V. Feigenbaum*—Best for customer use and selling price.

4. *Kaoru Ishikawa*—Quality of the product as well as after-sales services, quality of management, the company itself, and the human being.
5. *Joseph M. Juran*—Quality is fitness for use.
6. *John S. Oakland*—Quality is meeting customer's requirements.

Based on these definitions, it is possible to evolve a common definition of quality, which is mainly related to the manufacturing, processes, and service industries as follows:

- Meeting the customer's need
- Fitness for use
- Conforming to requirements

However, the definition of quality for construction projects is different from that of manufacturing or services industries as the product is not repetitive but a unique piece of work with specific requirements. Quality in construction projects is not only the quality of product and equipment used in the construction of a facility but the total management approach to complete the facility. The quality of construction depends mainly upon the control of construction, which is the primary responsibility of the contractor.

Quality in manufacturing is spread over a series of processes. Material and labor are input into these processes out of which a product is obtained. The output is monitored by inspection and testing at various stages of production. Any nonconforming product is identified as repaired, reworked, or scrapped, and proper steps are taken to eliminate problem causes. Statistical process control methods are used to reduce the variability and increase the efficiency of the process. However, in construction projects, the scenario is not the same. If anything goes wrong, the nonconforming work is very difficult to rectify, and remedial action is sometimes not possible.

The authors of *Quality in the Constructed Project* (2000) by the American Society of Civil Engineers (ASCE) have defined quality as

the fulfillment of project responsibilities in the delivery of products and services in a manner that meets or exceeds the stated requirements and expectations of the owner, design professional, and constructor. Responsibilities refer to the tasks that a participant is expected to perform to accomplish the project activities as specified by contractual agreement and applicable laws and licensing requirements, codes, prevailing industry standards, and regulatory guidelines. Requirements are what a team member expects or needs to receive during and after his or her participation in a project. (p. xv)

Chung (1999) states, "Quality may mean different things to different people. Some take it to represent customer satisfaction, others interpret it as compliance with contractual requirements, yet others equate it to attainment of prescribed standards" (p. 3). As regards quality of construction, he further

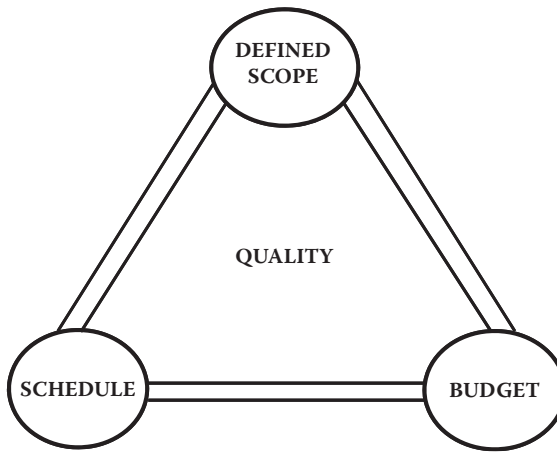

FIGURE 1.2
Construction project trilogy.

states, “Quality of construction is even more difficult to define. First of all, the product is usually not a repetitive unit but a unique piece of work with specific characteristics. Secondly, the needs to be satisfied include not only those of the client but also the expectations of the community into which the completed building will integrate. The construction cost and time of delivery are also important characteristics of quality” (p. 3).

Based on the foregoing, the quality of construction projects can be defined as follows: Construction project quality is the fulfillment of the owner’s needs per defined scope of works within a budget and specified schedule to satisfy the owner’s/user’s requirements. The phenomenon of these three components can be called the “construction project trilogy” and is illustrated in Figure 1.2.

1.3 Quality Inspection

Prior to the Industrial Revolution, items were produced by an individual craftsman, who was responsible for material procurement, production, inspection, and sales. In case any quality problems arose, the customer would take up issues directly with the producer. The Industrial Revolution provided the climate for continuous quality improvement. In the late 19th century, Fredrick Taylor’s system of Scientific Management was born. It provided the backup for the early development of quality management through inspection. At the time when goods were produced individually by craftsmen, they inspected their own work at every stage of production and discarded faulty items. When production increased with the development of technology, scientific

management was born out of a need for standardization rather than craftsmanship. This approach required each job to be broken down into its component tasks. Individual workers were trained to carry out these limited tasks, making craftsmen redundant in many areas of production. The craftsmen's tasks were divided among many workers. This also resulted in mass production at lower cost, and the concept of standardization started resulting in interchangeability of similar types of bits and pieces of product assemblies. One result of this was a power shift away from workers and toward management.

With this change in the method of production, inspection of the finished product became the norm rather than inspection at every stage. This resulted in wastage because defective goods were not detected early enough in the production process. Wastage added costs that were reflected either in the price paid by the consumer or in reduced profits. Due to the competitive nature of the market, there was pressure on manufacturers to reduce the price for consumers, which in turn required cheaper input prices and lower production costs. In many industries, emphasis was placed on automation to try to reduce the costly mistakes generated by workers. Automation led to greater standardization, with many designs incorporating interchanges of parts. The production of arms for the 1914–1918 war accelerated this process.

An inspection is a specific examination, testing, and formal evaluation exercise and overall appraisal of a process, product, or service to ascertain if it conforms to established requirements. It involves measurements, tests, and gauges applied to certain characteristics in regard to an object or an activity. The results are usually compared to specified requirements and standards for determining whether the item or activity is in line with the target. Inspections are usually nondestructive. Some of the nondestructive methods of inspection are

- Visual
- Liquid dyed penetrant
- Magnetic particle
- Radiography
- Ultrasonic
- Eddy current
- Acoustic emission
- Thermography

The degree to which inspection can be successful is limited by the established requirements. Inspection accuracy depends on

1. Level of human error
2. Accuracy of the instruments
3. Completeness of the inspection planning

Human errors in inspection are mainly due to

- Technique errors
- Inadvertent errors
- Conscious errors
- Communication errors

Most construction projects specify that all the contracted works are subject to inspection by the owner/consultant/owner's representative.

1.4 Quality Control

The quality control era started at the beginning of the 20th century. The Industrial Revolution had brought about the mechanism and marked the inclusion of process in quality practices. The ASQ termed the quality control era as process orientation that consists of product inspection and statistical quality control.

Thomas Pyzdek (1999) has described the start of the quality control era as follows:

The Inspection-based approach to quality was challenged by Walter A. Shewhart. In 1931, Shewhart's landmark book *Economic Control of Quality of Manufacturing* introduced the modern era of quality management. In 1924, Shewhart was part of a group working at Western Electric's Inspection Engineering Department of Bell Laboratories. Other members of the group included Harold Dodge, Harry Romig, G.D. Edwards, and Joseph Juran, a veritable "who's who" of the modern quality movement. (p. 13)

Pyzdek further states:

Quality continued to evolve after World War II. Initially, few commercial forms applied the new, statistical approach. However, those companies that did, achieved spectacular results, and the results were widely reported in the popular and business press. Interest groups, such as the Society of Quality Engineers (1945), began to form around the country. In 1946, the Society of Quality Engineers joined with other groups to form the American Society for Quality (ASQ). In July 1944, the Buffalo Society of Quality Engineers published *Industrial Quality Control*, the first journal devoted to the subject of management discipline. (p. 15)

According to Feigenbaum (1991), the definition of control in industrial terminology is "a process for delegating responsibility and authority for a

management activity while retaining the means of assuring satisfactory results." He further states:

The procedure for meeting the industrial goal is therefore termed quality 'Control,' just as the procedure for measuring production and cost goals are termed, respectively, production 'Control' and cost 'Control.' There are normally four steps in such control:

1. *Setting Standards.* Determining the required cost-quality, performance-quality, safety-quality, and reliability-quality standards for the products.
2. *Appraising Conformance.* Comparing the conformance of the manufactured product, or the offered service to the standards.
3. *Acting When Necessary.* Correcting problems and their causes throughout the full range of those marketing, design, engineering, production, and maintenance factors that influence user satisfaction.
4. *Planning of Improvements.* Developing a continuing effort to improve the cost, performance, safety, and reliability standards. (p. 10)

Kerzner (2001) describes that "quality Control is a collective term for activities and techniques, within the process, that are intended to create specific quality characteristics. Such activities include continually monitoring process, identifying and eliminating problem causes, use of statistical process control to reduce the variability and to increase the efficiency of the process. Quality control certifies that the organization's quality objectives are being met" (p. 1099).

Gryna (2001) refers to quality control as the process employed to consistently meet standards. The control process involves observing actual performances, comparing it with some standards, and then taking action if observed performance is significantly different from the standard. The control process is in the nature of a feedback loop as shown in Figure 1.3.

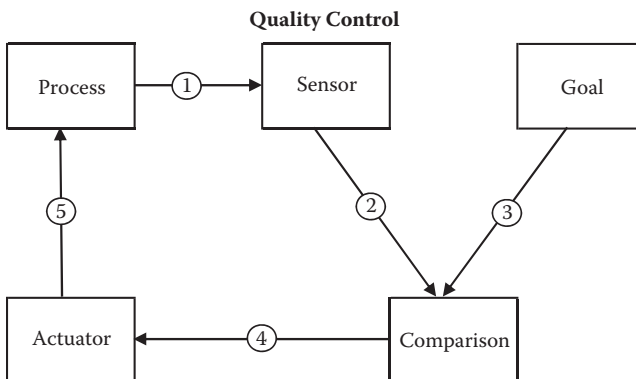

FIGURE 1.3

The feedback loop. (From F. Gryna, *Quality Planning & Analysis*, 2001. Reprinted with permission of McGraw-Hill.)

Control involves a universal sequence of steps as follows:

1. Choose the control subject, that is, choose what we intend to regulate.
2. Establish measurement.
3. Establish standard of performance, product goal, and process goals.
4. Measure actual performance.
5. Compare actual measured performance against standards.
6. Take action on the difference.

Juran (1999, p. 4.2) defines quality control as a universal managerial process for conducting operation so as to provide stability to prevent adverse change and to "maintain the status quo." To maintain stability, the quality control process evaluates actual performance, compares actual performance to goals and takes action on the difference.

Chung (1999, p. 4) defines quality control as referring to the activities that are carried out on the production line to prevent or eliminate causes of unsatisfactory performance. In the manufacturing industry, including production of ready-mixed concrete and fabrication of precast units, the major functions of quality control are control of incoming materials, monitoring of the production process, and testing of the finished product.

From the foregoing, quality control can be defined as a process of analyzing data collected through statistical techniques to compare with actual requirements and goals to ensure its compliance with some standards.

Quality control in construction projects is performed at every stage through the use of various control charts, diagrams, checklists, etc. and can be defined as

Checking of executed/installed works to confirm that works have been performed/executed as specified, using specified/approved materials, installation methods and specified references, codes, standards to meet intended use

Controlling budget

Planning, monitoring and controlling project schedule

A control chart is a graphical representation of the mathematical model used to detect changes in a parameter of the process. Charting statistical data is a test of the null hypothesis that the process from which the sample came has not changed. A control chart is employed to distinguish between the existence of a stable pattern of variation and the occurrence of an unstable pattern. If an unstable pattern of variation is detected, action may be initiated to discover the cause of the instability. Removal of the assignable cause should permit the process to return to stable state.

There are a variety of methods, tools, and techniques that can be applied for quality control and the improvement process. These are used to create an idea, engender planning, analyze the cause, analyze the process, foster evaluation, and create a wide variety of situations for continuous quality improvement. These tools can also be used during various stages of a construction project. The following are the most commonly used quality control tools for a variety of applications to improve the quality process:

1. Cause-and-effect diagram
2. Check sheet
3. Control chart
4. Data collection
5. Flow chart
6. Histogram
7. Pareto analysis
8. Pie chart
9. Run chart
10. Scatter diagram

These tools can be applied at various stages of construction projects to analyze causes of rejection and take necessary preventive or remedial action; develop a system for the preparation and processing of design drawings and documents, execution/installation of work, processing of shop drawings; tabulation of data in the form of a checklist; preparation of construction schedule requirements; and many other applications.

A brief definition of these quality tools is as follows (values shown in the figures are indicative only):

1. The cause-and-effect diagram is also called an Ishikawa diagram or fishbone diagram. It is used to organize and graphically display multiple causes with a particular effect. Figure 1.4 illustrates an example of a cause-and-effect diagram for bad concrete (failure to comply with design concrete strength).
2. A check sheet is a structured list, prepared from the collected data, to indicate how often each item occurs. Table 1.2 illustrates a checksheet for approval record.
3. The control chart is the fundamental tool of statistical process control. It is a graph used to analyze variation in a process. By comparing current data to historically determined lines, one can arrive at a conclusion regarding whether the process is stable or is being affected by special cause of variation. There are many types of control charts. Each is designed for a specific kind of process or data.

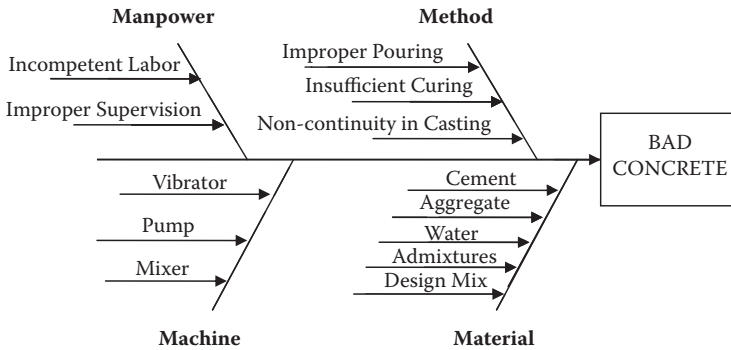

FIGURE 1.4
Cause-and-effect diagram for bad concrete.

TABLE 1.2
Check Sheet

	Approval Record for a Particular Month			
	Approved	Not Approved	Total	% Not Approved
Shop drawing			15	20
Material			10	30
Checklists			25	12

A control chart is employed to distinguish between the existence of a stable pattern of variation and the occurrence of an unstable pattern. Figure 1.5 illustrates sound level results of an audiovisual system.

4. Data collection objectives are to

- Identify the problem
- Report the problem
- Verify the problem
- Analyze the problem
- Correct the problem

5. A flowchart is a pictorial tool that is used for representing a process in sequential order. Flowcharts can be applied at all stages of the project life cycle. Figure 1.6 illustrates a flowchart for concrete casting.

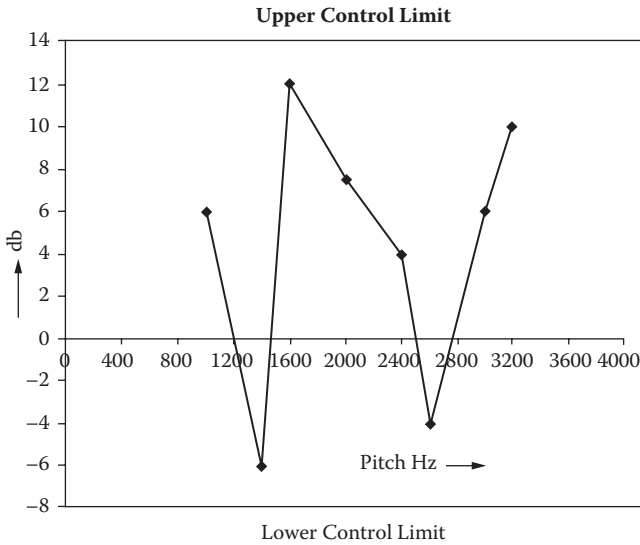

FIGURE 1.5
Control chart for A/V system.

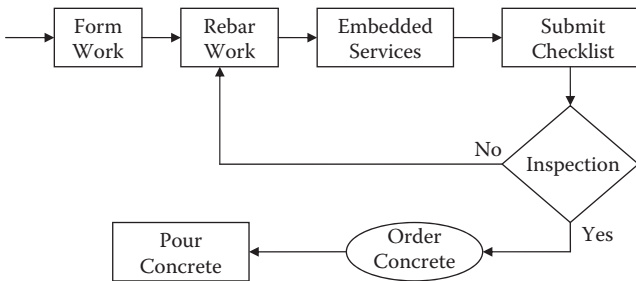

FIGURE 1.6
Flowchart for concrete casting.

6. The histogram is a pictorial representation of a set of data. It is created by grouping measurements into cells, and it displays how often the different values occur. Figure 1.7 illustrates a histogram for manpower for a period of one month.
7. Pareto analysis is a graphical representation of frequency of occurrence. Pareto charts are used to identify those factors that have the greatest cumulative effect on the system, and thus, less significant factors can be screened out from the process. Pareto analysis can be

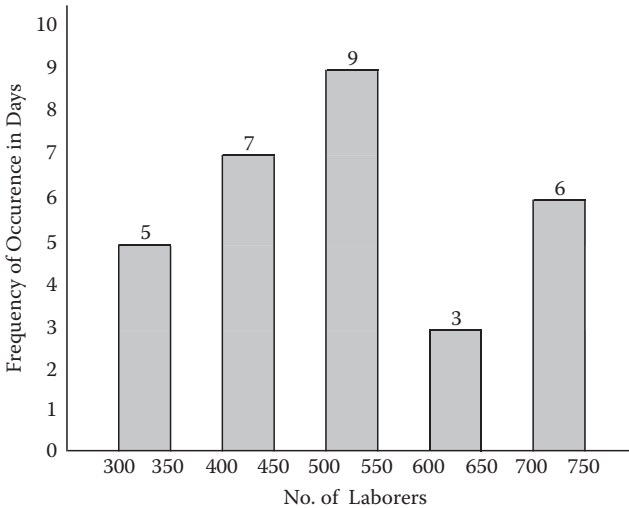

FIGURE 1.7
Histogram for manpower.

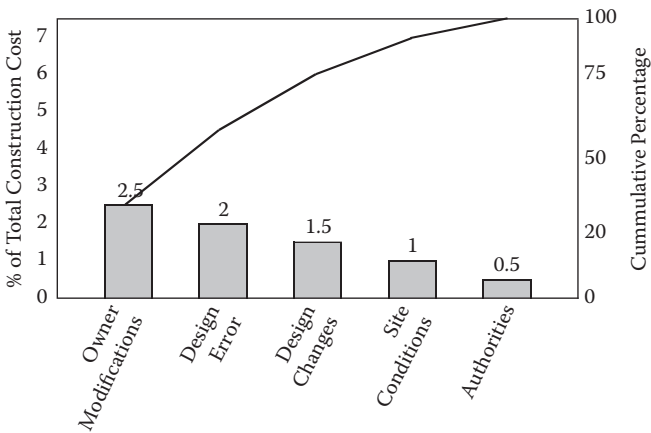

FIGURE 1.8
Pareto analysis for variation cost.

used at various stages in a quality improvement program to determine which step to take next. Figure 1.8 illustrates a Pareto chart for variation cost.

- The pie chart is a circle divided into wedges to depict proportion of data or information in order to understand how they make up the whole. The portions of entire circle or pie sum up to 100%. Figure 1.9 illustrates the contents of construction project cost.

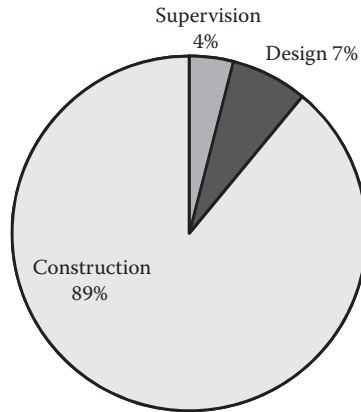

FIGURE 1.9
Pie chart for content of construction project cost.

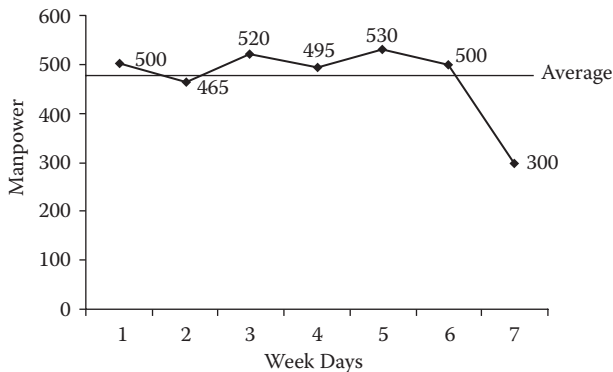

FIGURE 1.10
Run chart for manpower.

9. The run chart is a graph plotted by showing measurement (data) against time. Run charts are used to know the trend or changes in the average and also to determine if the pattern can be attributed to common causes of variation, or if special causes of variation were present. Figure 1.10 illustrates a run chart for manpower at a site for a particular week. It is similar to the control chart but does not show control limits.
10. The scatter diagram is a plot of one variable versus another. It is used to identify potential root cause of problems and to evaluate cause-and-effect relationship. Figure 1.11 illustrates a scatter diagram for length versus height of rods.

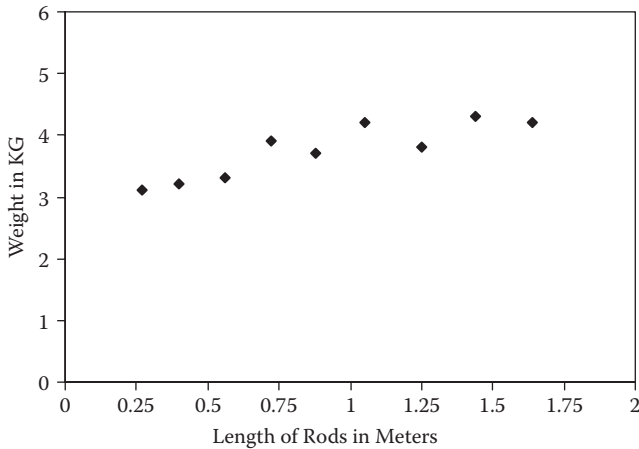

FIGURE 1.11
Scatter diagram.

1.5 Quality Assurance

Quality assurance is the third era in the quality management system.

The ASQ defines quality assurance as “all the planned and systematic activities implemented within the quality system that can be demonstrated to provide confidence a product or service will fulfill requirements for quality.”

ASQ details this era:

After entering World War II in December 1941, the United States enacted legislation to help gear the civilian economy to military production. At that time, military contracts were typically awarded to manufacturers who submitted the lowest competitive bid. Upon delivery, products were inspected to ensure conformance to requirements.

During this period, quality became a means to safety. Unsafe military equipment was clearly unacceptable, and the armed forces inspected virtually every unit of product to ensure that it was safe for operation. This practice required huge inspection forces and caused problems in recruiting and retaining competent inspection personnel. To ease the problems without compromising product safety, the armed forces began to utilize sampling inspection to replace unit-by-unit inspection. With the aid of industry consultants, particularly the Bell Laboratories, they adapted sampling tables and published them in a military standard: Mil-Std-105. The tables were incorporated into the military contracts themselves. In addition to creating military standards, the armed forces helped their suppliers improve their quality by sponsoring training courses in Shewhart’s statistical quality

control (SQC) techniques. While the training led to quality improvements in some organizations, most companies had little motivation to truly integrate the techniques. As long as government contracts paid the bills, organizations' top priority remained meeting production deadlines. Most SQC programs were terminated once the government's contracts came to an end.

According to ISO 9000 (or BS 5750), quality assurance is "those planned and systematic actions necessary to provide adequate confidence that product or service will satisfy given requirements for quality." ISO 8402-1994 defines quality assurance as "all the planned and systematic activities implemented within the quality system, and demonstrated as needed, to provide adequate confidence that an entity will fulfill requirements for quality."

The third era of quality management saw the development of quality systems and their application principally to the manufacturing sector. This was due to the impact of the following external environment upon the development take-up of quality systems at this time:

- Growing, and more significantly, maturing populations
- Intensifying competition

These converging trends contributed greatly to the demand for more, cheaper, and better quality products and services. The result was the identification of quality assurance schemes as the only solution to meet this challenge.

Harold Kerzner (2001) has defined quality assurance as the collective term for the formal activities and managerial processes that are planned and undertaken in an attempt to ensure that products and services are delivered at the required quality level. Quality assurance also includes efforts external to these processes that provide information for improving the internal processes. It is the quality assurance function that attempts to ensure that the project scope, cost, and time function are fully integrated (p. 1098).

According to Frank M. Gryna (2001),

Quality Assurance is the activity of providing evidence to establish confidence that quality requirements will be met. . . . Quality Assurance is similar to the concept of the financial audit, which provides assurance of financial integrity by establishing, through "independent" audit, that the plan of accounting is (1) such that, if followed, it will correctly reflect the financial condition of the company, and (2) that it is actually being followed. Today, independent financial auditors (certified public accountants) have become an influential force in the field of finance. (p. 659)

Brian Thorpe, Peter Sumner, and John Duncan (1996) have described quality assurance as the evolution of QA from techniques of final inspection in the 1930s, followed by quality control, mainly in the manufacturing industries, during 1940s and 1950s, then a further extension of controls into the engineering/design phases of these industries during the 1960s.

They further state:

The term “quality assurance” unfortunately tends to make people think of the finished product and services, whereas it is something far greater; in fact, today’s quality system is not something imposed on top of other business systems; it is the system of the business. Our definition of quality assurance is a structural approach to business management and control, which enhances the ability to consistently provide products and services to specification, program and cost. (p. 9)

Quality assurance is the activity of providing evidence to establish confidence among all concerned that quality-related activities are being performed effectively. All these planned or systematic actions are necessary to provide adequate confidence that a product or service will satisfy given requirements for quality.

Quality assurance covers all activities from design, development, production/construction, installation, and servicing to documentation, and also includes regulations of the quality of raw materials, assemblies, products, and components; services related to production; and management, production, and inspection processes.

Quality assurance in construction projects covers all activities performed by the design team, contractor and quality controller/auditor (supervision staff) to meet owners’ objectives as specified and to ensure that the project/facility is fully functional to the satisfaction of the owners/end users.

1.6 Quality Engineering

Feigenbaum (1991) defines quality engineering technology as “the body of technical knowledge for formulating policy and for analyzing and planning product quality in order to implement and support that quality system which will yield full customer satisfaction at minimum cost” (p. 234).

Figure 1.12 illustrates the counterpart triangle for quality engineering.

Quality engineering becomes the field, or apex, of the triangle. The technical work area of the discipline—quality systems implementation—is shown in the first tier. The second tier then shows the principal techniques of quality engineering technology. Quality engineering relates the particular requirements of the plant and companies to the available quality technology—including both hardware equipment and planning and control actions—to put in place much of the ongoing operating detail of the quality systems framework for the firm.

Quality engineering technology thus provides the technical areas to deal with such questions as the following: What are the specific details of the control activities to take place during the development and production and service cycles? Will these quality activities best be accomplished through the

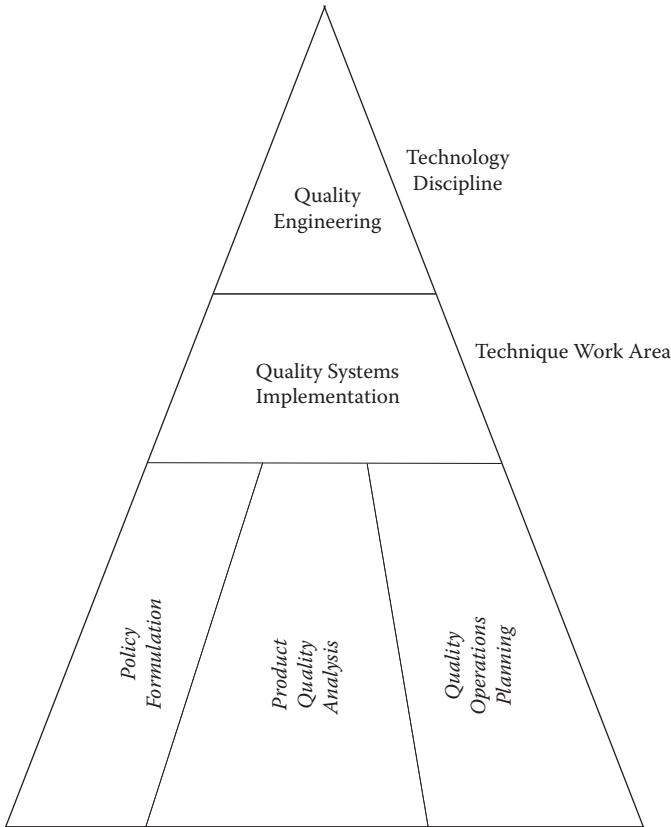

FIGURE 1.12

Quality engineering triangle. (From A.V. Feigenbaum, *Total Quality Control*, 1991. Reprinted with permission of The McGraw-Hill Companies.)

use of quality information equipment or by the use of people guided by procedures? What information and material inputs will be needed? What type of information data is required? How should it be analyzed, and what sort of feedback should be used?

Depending upon the differences in the product-quality levels encountered, what criteria are there for alternative courses of corrective action?

Feigenbaum (1991) has further elaborated the entire range of techniques used in quality engineering technology by grouping them under three major headings:

1. *Formulating of quality policy.* Included here are techniques for identifying the quality objectives and quality policy of a particular company as a foundation for quality analysis and systems implementation.
2. *Product-quality analysis.* Techniques for analyzing include those for isolating and identifying the principal actors that relate to the quality

- of the product in its served market. These factors are then studied for their effects toward producing the desired quality result.
3. *Quality operations planning.* Techniques for implementing the quality system emphasize the development in advance of a proposed course of action and methods for accomplishing the desired quality result. These are the quality planning techniques underlying—and required by—the documentation of key activities of the quality system. (p. 237)

Table 1.3 lists the major work elements normally performed by quality specialists.

TABLE 1.3

Work Elements

Reliability engineering	Establishing reliability goals Reliability apportionment Stress analysis Identification of critical parts Failure mode, effects, and criticality analysis (FMECA) Reliability prediction Design review Supplier selection Control of reliability during manufacturing Reliability testing Failure reporting and corrective action system
Quality engineering	Process capability analysis Quality planning Establishing quality standards Test equipment and gage design Quality troubleshooting Analysis of rejected or returned material Special studies (measurement error, etc.)
Quality assurance	Write quality procedures Maintain quality manual Perform quality audits Quality information systems Quality certification Training Quality cost systems
Inspection and test	In-process inspection and test Final product inspection and test Receiving inspection Maintenance of inspection records Gage calibration
Vendor quality	Preaward vendor surveys Vendor quality information systems Vendor surveillance Source inspection

Source: Pyzdek, T. (1999). *Quality Engineering Handbook*. Reprinted with permission from Quality America, Inc.

1.7 Quality Management

The ASQ glossary defines quality management as “the application of quality management system in managing a process to achieve maximum customer satisfaction at the lowest overall cost to the organization while continuing to improve the process.”

Thomas Pyzdek (1999) has described the evolution of the quality management concept:

The quality assurance perspective suffers from a number of serious shortcomings. Its focus is internal. Specifications are developed by the designers, often with only a vague idea of what customers really want. The scope of quality assurance is generally limited to those activities under the direct control of the organization; important activities such as transportation, storage, installation, and service are typically either ignored or given little attention. Quality assurance pays little or no attention to the competition's offerings. The result is that quality assurance may present a rosy picture, even while quality problems are putting the firm out of business. Such a situation existed in the United States in the latter 1970s.

The approaches taken to achieve the quality edge vary widely among different firms. Some quality leaders pioneer and protect their positions with patents or copyrights. Others focus on relative image or service. Some do a better job of identifying and meeting the needs of special customer segments. And others focus on value-added operations and technologies.

Once a firm obtains a quality advantage, it must continuously work to maintain it. As markets mature, competition erodes any advantage. Quality must be viewed from the customer's perspective, not as conformance to self-imposed requirements. Yet a quality advantage often cannot be obtained only by soliciting customer input, since customers usually are not aware of potential innovations. (p. 19)

Figure 1.13 depicts the Total Quality System (TQS) process. The TQS makes it clear that the quality specialist shares responsibility for quality with many others in the company.

According to Juran and Godfrey (1999, p. 41.7),

At the end of World War II, the former Japanese military and political leaders were no longer in power, having been replaced in large part by relatively young industrialists who wanted Japan to advance as an industrialized country and not to fall back into the old agricultural economy of the type prevalent in some parts of developing countries. After this decision was made, however, they faced a difficult road: poor product quality was a principal obstacle; no one wanted to repeatedly buy such low quality goods. For a country so lacking in raw materials, the inability to sell finished goods for export also meant an inability to

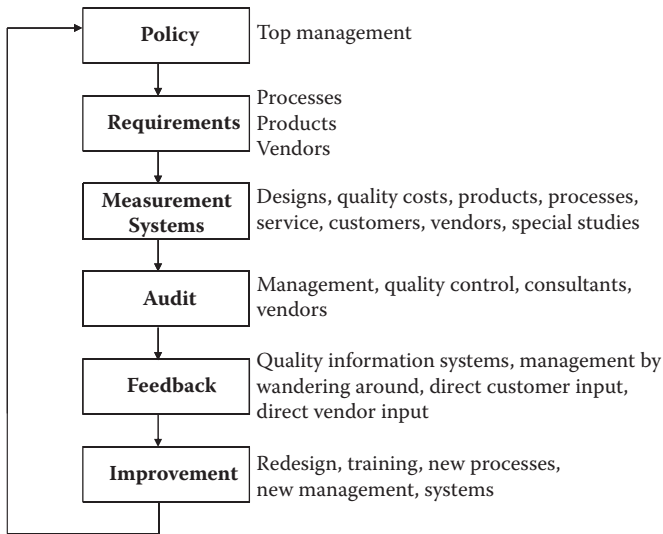

FIGURE 1.13 Total quality system. (From T. Pyzdek, *Quality Handbook*, 1999. Reprinted with permission from Quality America, Inc.)

earn foreign currency and hence an inability to buy the materials needed to create an upward spiral of industrial development. Thus, a revolution in product quality became essential. This quality revolution has been taking place in Japan since the early 1950s as the result of efforts to apply the concepts and techniques of statistical quality control on a company wide scale.

Juran (Juran and Godfrey 1999, p. 41.11) further states:

Introduction and promotion of company wide quality control led to a revolution in management philosophy, which required lengthy, preserving efforts in education and training. Thus, since the early 1950s, education and training in quality control have been continued for everyone from top management to first time workers in each and every department, including research and development designing, manufacturing, inspection, purchasing, marketing, sales and administration.

According to Feigenbaum (1991),

Systems Engineering and Management is the foundation for Total Quality Control. . . . Total-Quality-Control work requires effective ways to integrate the efforts of large numbers of people with large numbers of machines and huge quantities of information. Hence, it involves systems,

questions of significant proportions, and a systems approach is inherent in total quality control.

Historically, the meaning of the word “systems” has varied over a complete spectrum—from a “paperwork” office procedure at one extreme through a “software” computer program to a “hardware” equipment system at the other extreme. In quality control, the term “systems” has meant anything from factory troubleshooting procedures to a shelf of operating “manuals” and “handbooks” covering all product inspection and test routines.

Experience has shown that these approaches have been too narrow. Effective quality control requires the strong coordination of all the relevant paperwork and software and hardware and handbook activities. It requires the integration of the quality actions of the people, the machines, and the information into strong total quality systems. This book refers to this comprehensive systems approach when it uses the phrase “quality system,” or as a definition.

A quality system is the agreed on, companywide and plant wide operating work structure, documented in effective, integrated technical and managerial procedures, for guiding the coordinated actions of the people, the machines, and the information of the company and plant in the best and most practical ways to assure customer quality satisfaction and economical costs of quality.

A clearly defined and thoroughly installed total quality system is a powerful foundation for total quality control, organizationwide, and for total quality management. Without such systematic integration in a company, “quality management by anticipation” may remain a slogan and a conversation piece, but the actual condition can be quality management by crises and reaction to complaints. Quality can be a consequence rather than the result of carefully planned objectives and activities; it can be the end product of individual, sometimes unlinked, actions throughout the entire marketing–engineering–production–service–quality process. It can be based upon sincere intentions but not guided by firm, quantitative customer quality targets implemented by clear organizationwide programs.

In contrast to this, strong quality systems provide a management and engineering basis for effective prevention-oriented control that deals economically and soundly with the present levels of human, machine, and informational complexity that characterize today’s company and plant operations.

The new technologies of systems engineering and systems management are important bases for the establishment and the continuing operation and administration of quality systems. That this is so has fundamental technical and managerial impacts upon the work of the quality-control function as follows:

- Systems engineering is likely to provide what might be thought of as the fundamental “design technology” of the modern quality engineer.

- Systems management is likely to become a fundamental management guide for the quality manager.
- Systems economics, particularly with respect to formalized total quality cost accounting, is likely to provide a major business guide-control point for the general manager.

Gryna (2001) states:

Following World War II, two major forces emerged that have had a profound impact on quality. The first force was the Japanese revolution in quality. Prior to World War II, many Japanese products were perceived, throughout the world, to be poor in quality. To help sell their products in international markets, the Japanese took some revolutionary steps to improve quality:

1. Upper-level managers personally took charge of leading the revolution.
2. All levels and functions received training in the quality disciplines.
3. Quality improvement projects were undertaken on a continuing basis at a revolutionary pace.

The Japanese success has been almost legendary. The second major force to affect quality was the prominence of product quality in the public mind. Several trends converged to highlight this prominence: product liability cases; concern about the environment; some major disasters and near disasters; pressure by consumer organizations; and the awareness of the role of quality in trade; weapons and other areas of international competition. (p. 2)

According to Gryna, "During the 20th century, a significant body of knowledge emerged on achieving superior quality. Many individuals contributed to this knowledge, and five names deserve particular attention: Juran, Deming, Feigenbaum, Crosby and Ishikawa." He further states, "The approaches of these matters have similarities as well as differences,—particularly in the relative emphasis as managerial, statistical, technological and behavioral elements" (p. 3).

According to J.L. Ashford (1989):

After the second World War the economy of Japan was in ruins. To attain their military objectives, all available resources of capital and of technical manpower had been directed to armaments manufacture, while their civilian economy gained an unenviable reputation for producing poor quality copies of products designed and developed elsewhere. Unless they were able to raise the quality of their products to a level which could compete, and win, in the international marketplace, they stood no chance of becoming a modern industrialized nation.

To learn how to regenerate their industries, they sent a team abroad to study the management practices of other countries and they invited foreign experts to provide advice. Among the latter were two Americans, J.M. Juran and W.E. Deming, who brought a new message, which can be summarized as follows.

1. The management of quality is crucial to company survival and merits the personal attention and commitment of top management.
2. The primary responsibility for quality must lie with those doing the work. Control by inspection is of limited value.
3. To enable a production department to accept responsibility for quality, management must establish systems for the control and verification of work, and must educate and indoctrinate the work force in their application.
4. The costs of education and training for quality, and other costs which might be incurred, will be repaid many times over by greater output, less waste, a better quality product and higher profits.

These are the basic principles of management concepts which have since become identified under the generic term of quality management. (p. 5)

Thus, the concept of quality management started after World War II, broadening into the development of initiatives that attempt to engage all employees in the systematic effort for quality. Quality management resulted from the work of the “quality gurus” and their theories. Extension of quality management concepts gave birth to Total Quality Management (TQM).

1.8 Quality Gurus

The TQM approach was developed immediately after World War II. There are prominent researchers and practitioners whose work has dominated this movement. Their ideas, concepts, and approaches in addressing specific quality issues have become part of the accepted wisdom in TQM, resulting in a major and lasting impact within the field. These persons have become known as “quality gurus.” They all emphasize involvement of organizational management in the quality efforts. These philosophers are

1. Philip B. Crosby
2. W. Edwards Deming
3. Armand V. Feigenbaum
4. Kaoru Ishikawa
5. Joseph M. Juran
6. John S. Oakland
7. Shigeo Shingo
8. Genichi Taguchi

A brief summary of their philosophy and approaches is given next.

1.8.1 Philip B. Crosby

Crosby’s philosophy is seen by many to be encapsulated in his five “Absolute Truths of Quality Management.” These are

1. Quality is defined as conformance to requirement, not as “goodness” or “elegance.”
2. There is no such thing as a quality problem.
3. It is always cheaper to do it right the first time.
4. The only performance measurement is the cost of quality.
5. The only performance standard is zero defects.

Crosby’s perspective on quality has three essential beliefs:

1. A belief in qualification
2. Management leadership
3. Prevention rather than cure

Crosby’s principal method is his 14-step program for quality management and is illustrated in Figure 1.14. His main emphasis is the quantitative, that is, the performance standard of “zero defects.”

Step	Description of Quality Program
Step 1	Establish management commitment
Step 2	Form quality improvement teams
Step 3	Establish quality measurements
Step 4	Evaluate the cost of quality
Step 5	Raise quality awareness
Step 6	Take action to correct problems
Step 7	Zero defects planning
Step 8	Train supervisors and managers
Step 9	Hold a “Zero Defects” day to establish the attitude and expectation within the company
Step 10	Encourage the setting of goals for improvement
Step 11	Obstacle reporting
Step 12	Recognition for contributors
Step 13	Establish quality councils
Step 14	Do it all over again

FIGURE 1.14 Fourteen-step quality program. (From P.B. Crosby, *Quality Is Free*, McGraw-Hill, 1979. Reprinted with permission of The McGraw-Hill Companies.)

1.8.2 W. Edwards Deming

Deming was perhaps the best-known figure associated with the quality field and is considered its founding father. His philosophy is based on four principal methods:

1. The Plan–Do–Check–Act (PDCA) Cycle
2. Statistical process control
3. The 14 principles of transformation
4. The seven-point action plan

1.8.2.1 PDCA Cycle

Figure 1.15 illustrates the PDCA cycle: Plan, Do, Check, and Act. This cycle is iterative; once it has been completed, it recommences without ceasing. The approach is seen as reemphasizing the responsibility of management to be actively involved in the organization's quality program. The PDCA cycle is also known as the Plan–Do–Study–Act (PDSA) cycle.

Nancy R. Tague (2005, p. 391) has elaborated on the PDCA cycle as follows:

Description

The PDCA or PDSA cycle consists of a four-step model for carrying out change. Just as a circle has no end, the PDCA cycle should be repeated again and again for continuous improvement. PDCA is a basic model that can be compared to the continuous improvement process, which can be applied on a small scale.

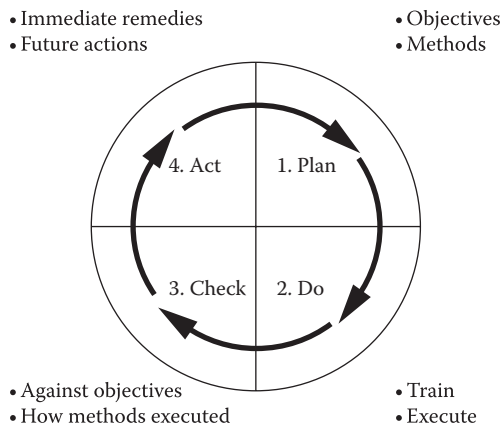

FIGURE 1.15

PDCA cycle. (Adapted from H. Kerzner, *Project Management*, 2001. Reprinted with permission of John Wiley & Sons, Inc.)

When to use

- As a model for continuous improvement
- When starting a new improvement project
- When developing a new or improved design of process, product, or service
- When defining a repetitive work process
- When planning data collection and analysis in order to verify and prioritize problems or root causes
- When implementing any change

Procedure

1. *Plan.* Recognize an opportunity and plan the change.
2. *Do.* Test the change; carry out a small-scale study.
3. *Check.* Review the test, analyze the results, and identify learnings.
4. *Act.* Take action based on what you learned in the study step. If the change did not work, go through the cycle again with a different plan. If you were successful, incorporate the learning from the test into wider changes. Use what you learned to plan new improvements, beginning the cycle again.

PDCA is mainly used for continuous-process improvement. The PDCA cycle, when used as a process improvement tool for design improvement/design conformance in construction projects to meet owner's requirements, shall indicate the following actions:

Plan: Establish scope.

Do: Develop design.

Check: Review and compare.

Act: Implement comments, take corrective action, and/or release contract documents to construct/build the project/facility.

Figure 1.16 illustrates the PDCA cycle model for conformance of construction projects designed to owner requirements/scope of work.

1.8.2.2 Statistical Process Control

Statistical Process Control (SPC) is a quantitative approach based on the measurement of process control. Deming believed in the use of SPC charts as the key method for identifying special and common causes and assisting diagnosis of quality problems. His aim was to remove "outliers," that is, quality problems relating to the special causes of failure. This was achieved through training, improved machinery and equipment, and so on. SPC enabled the production process to be brought "under control."

The remaining quality problems were considered to be related to common causes, that is, they were inherent in the design of the production process.

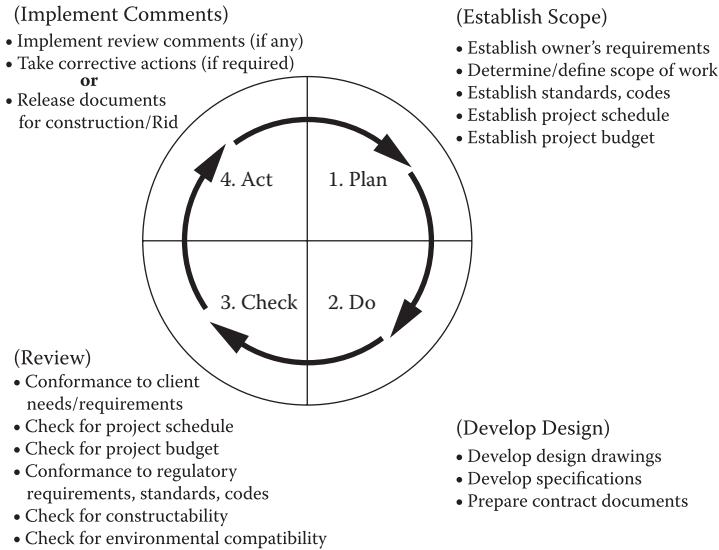

FIGURE 1.16
PDCA cycle for construction projects (design phases).

Eradication of special causes enabled a shift in focus to common causes to further improve quality.

Gryna (2001) describes statistical process control as the application of statistical methods to the measurement and analysis of variation in a process. This technique applies to both in process parameters and end process (product) parameters (p. 495). He further states that “a statistical control chart compares process performance data to computed ‘statistical control limits,’ drawn as limit lines on the chart” (p. 498).

Table 1.4 illustrates types of charts and applications.

Table 1.5 compares three basic control charts.

1.8.2.3 14 Principles for Transformation

Deming’s 14 principles for transformation are listed in Table 1.6.

1.8.2.4 The Seven-Point Action Plan

In order to implement the 14 principles, Deming proposed a seven-point action plan. These are listed in Figure 1.17.

1.8.3 Armand V. Feigenbaum

Feigenbaum defines quality as “best for the customer use and selling price,” and quality control as an effective method for co-coordinating the quality

TABLE 1.4
Types of Control Charts and Applications

Variables Charts	Attributes Charts
\bar{X} and R charts: To observe changes in the mean and range (variance) of a process	p charts: For the fraction of attributes nonconforming or defective in a sample of varying size
\bar{X} and s charts: For a variable average and standard deviation	np charts: For the number of attributes nonconforming or defective in a sample of constant size
\bar{X} and s^2 charts: For a variable average and variance	c charts: For the number of attributes nonconforming or defects in a single item within a subgroup, lot, or sample area of constant size
	u charts: For the number of attributes nonconforming or defects in a single item within a subgroup, lot, or sample area of varying size

Source: Kerzner, H. (2001). *Project Management*. Reprinted with permission of John Wiley & Sons, Inc.

maintenance and quality improvement efforts at the various groups in an organization, so as to enable production at the most economical levels that allow for full customer satisfaction. Feigenbaum’s philosophy of quality has a four-step approach. These are:

- Step 1. Set quality standards
- Step 2. Appraise conformance to standards
- Step 3. Act when standards are not met
- Step 4. Plan to make improvements

Figure 1.18 illustrates Feigenbaum’s technology triangle, relating the engineering technologies to the overall field of total quality control.

1.8.4 Kaoru Ishikawa

The founding philosophy of Ishikawa approach is “companywide quality control.” He has identified 15 effects of companywide quality control. Ishikawa’s approach deals with organizational aspects and is supported by the “quality circles” technique and the “seven tools of quality control.” Quality circles are Ishikawa’s principal method for achieving participation, composed of 5 to 15 workers from the same area of achieving, and led by a foreman or supervisor who acts as a group leader to liaison between the workers and the management. The function of quality circles is to

TABLE 1.5

Comparison of Some Control Charts

Statistical Measure Plotted	Average \bar{X} and Range R	Percentage Nonconforming (p)	Number of Nonconformities (c)
Type of data required	Variable data (measured values of a characteristic)	Attribute data (number of defective units of product)	Attribute data (number of defects per unit of product)
General field of application	Control of individual characteristics	Control of overall fraction defective of a process	Control of overall number of defects per unit
Significant advantages	Provides maximum utilization of information available from data Provides detailed information on process average and variation for control of individual dimensions	Data required are often already available from inspection records Easily understood by all personnel Provides an overall picture of quality	Same advantages as p chart but also provides a measure of defectiveness
Significant disadvantages	Not understood unless training is provided; can cause confusion between control limits and tolerance limits Cannot be used with go/no go type of data	Does not provide detailed information for control of individual characteristics Does not recognize different degrees of defectiveness in units of product	Does not provide detailed information for control of individual characteristics
Sample size	Usually four or five	Use given inspection results or samples of 25, 50, or 100	Any convenient unit of product such as 100 feet of wire or one television set

Source: Gryna, F. (2001). *Quality Planning & Analysis*. Reprinted with permission of The McGraw-Hill Companies.

identify local problems and recommend the solutions. The aim of quality circles is to

- Contribute to the improvement and development of the enterprise
- Respect human relations and build a happy workshop offering job satisfaction
- Deploy human capabilities fully and draw out infinite potential

TABLE 1.6

14 Principles of Transformation: W. Edwards Deming

THE QUALITY GURUS	
W. Edwards Deming	
Principle 1	Create constancy of purpose to improve product and service.
Principle 2	Adopt a new philosophy for the new economic age with management learning what their responsibilities are and by assuming leadership for change.
Principle 3	Cease dependence on mass inspection to achieve quality by building quality into the product.
Principle 4	End awarding business on price. Award business on total cost and move toward single suppliers.
Principle 5	Aim for continuous improvement of the system of production and service to improve productivity and quality and to decrease costs.
Principle 6	Institute training on the job.
Principle 7	Institute leadership with the aim of supervising people to help them to do a better job.
Principle 8	Drive out fear so that everyone can work effectively together for the organization.
Principle 9	Break down barriers between departments. Encourage research, design, sales and production to work together to foresee difficulties in production and use.
Principle 10	Eliminate slogans, exhortations and numerical targets for the workforce since they are divisory and difficulties belong to the whole system.
Principle 11	Eliminate quotas or work standards and management by objectives or numerical goals; leadership should be substituted instead.
Principle 12	Remove barriers that rob people of their right to pride in their work.
Principle 13	Institute a vigorous education and self-improvement program.
Principle 14	Put everyone in the company to work to accomplish the transformation.

Source: Deming, W.E., *Out of Crisis*, 2000. Reprinted with permission of MIT Press.

Kerzner (2001) states:

Quality circles are small groups of employees who meet frequently to help resolve company quality problems and provide recommendations to management. Quality circles were initially developed in Japan and only recently have achieved some degree of success in United States. The employees involved in quality circles meet frequently either at someone's home or at the plant before the shift begins. The group identifies problems, analyzes data, recommends solutions, and carries out management-approved changes. The success of quality circles is heavily based upon management's willingness to employ recommendations.

He further states:

The key elements of quality circles include

- They are a team effort.
- They are completely voluntary.
- Employees are trained in group dynamics, motivation, communications, and problem solving.

Point 1	Management must agree on the meaning of the quality program, its implications and the direction to take.
Point 2	Top management must accept and adopt the new philosophy.
Point 3	Top management must communicate the plan and the necessity for it to the people in the organization.
Point 4	Every activity must be recognized as a step in a process and the customers of that process identified. The customers are responsible for the next stage of the process.
Point 5	Each stage must adopt the “Deming” or “Shewhart” cycle—Plan, Do, Check, Action—as the basis of quality improvement.
Point 6	Team work must be engendered and encouraged to improve inputs and outputs. Everyone must be enabled to contribute to this process.
Point 7	Construct organization for quality with the support of knowledgeable statisticians.

FIGURE 1.17

Seven-point action plan. (Adapted from Deming, W.E., *Out of the Crisis*, 2000. Reprinted with permission of MIT Press.)

- Members rely upon each other for help.
- Management support is achieved but as needed.
- Creativity is encouraged.
- Management listens to recommendations.

And the benefits of quality circles include

- Improved quality of products and services
- Better organizational communications
- Improved worker performance
- Improved morale (p. 1131)

Table 1.7 lists the points to be considered for the formation of the quality circle.

The quantitative techniques of the Ishikawa approach are referred as “Ishikawa’s Seven Tools of Quality Control,” listed in Figure 1.19. The approach includes both quantitative and qualitative aspects, which, taken together, focus on achieving companywide quality.

These form a set of pictures of quality, representing in diagrammatic or chart form the quality status of the operation of process being reviewed. Ishikawa considered that all staff should be trained in these techniques as they have a useful role to play in managing quality.

Ishikawa developed a technique of graphically displaying the causes of any quality problem. His method is called by several names, such as the Ishikawa diagram, fishbone diagram, and cause-and-effect diagram. The Ishikawa diagram is essentially an end or goal-oriented picture of a problem situation. It is based around a set of “M” causes such as Manpower (personnel), Machine (plant and equipment), Material (raw material and parts), Method (techniques and technology), Measurement (sampling, instrumentation), and Mother Nature (environment). Figure 1.20 illustrates the Ishikawa diagram.

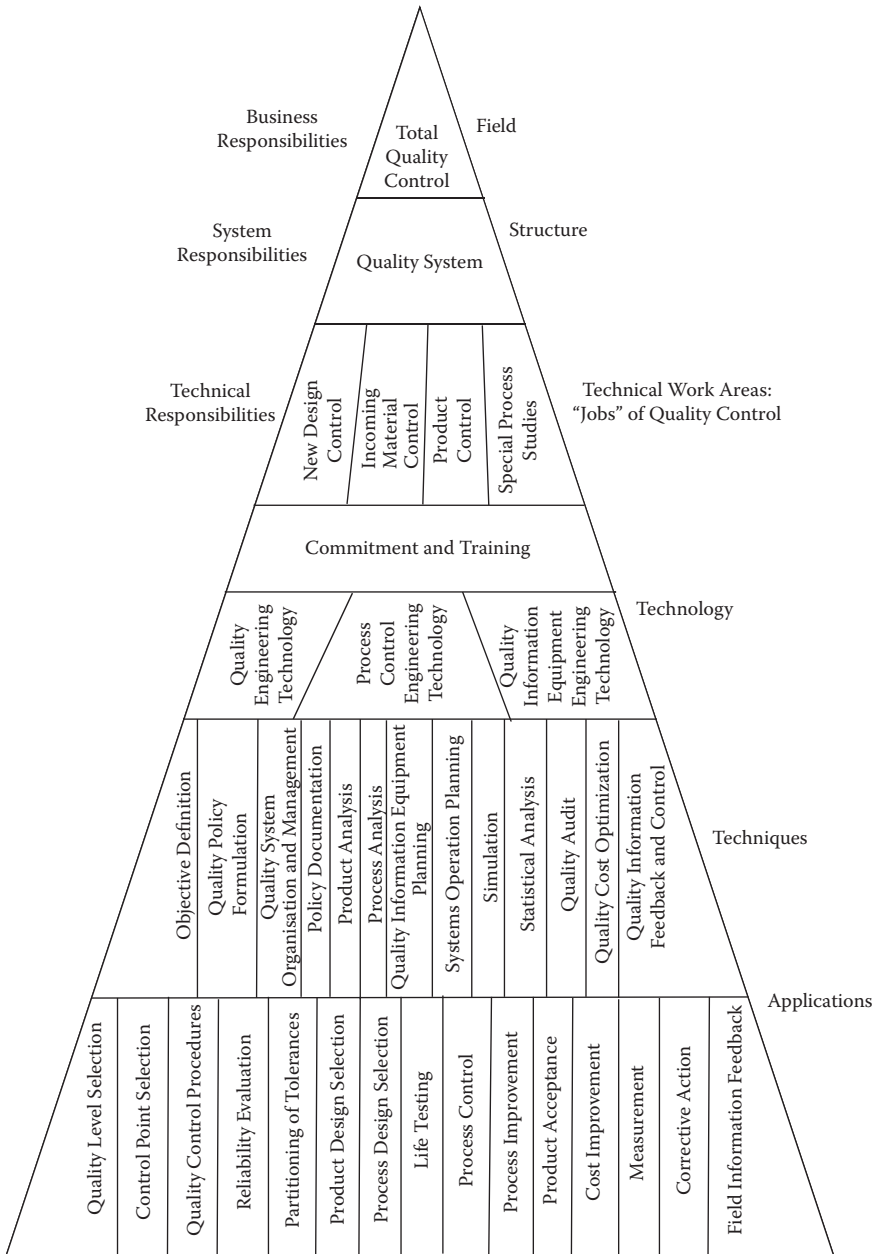

FIGURE 1.18 Technological triangle. (From A.V. Feigenbaum, *Total Quality Control*, 1991. Reprinted with permission of The McGraw-Hill Companies.)

TABLE 1.7

Four Points for Formation of Quality Circles: Kaoru Ishikawa

THE QUALITY GURUS
Kaoru Ishikawa

1. Voluntarism: Circles are to be created on voluntary basis, and not by a command from above. Begin circle activities with people who wish to participate.
 2. Self-development: Circle members must be willing to study.
 3. Mutual development: Circle members must aspire to expand their horizons and cooperate with other circles.
 4. Eventual total participation: Circles must establish their ultimate goal of full participation of all workers in the same workplace.
-

Source: Ishikawa, K. (1985). *What is Total Quality Control? The Japanese Way*. D. J. Lu, tr. Reprinted with permission from Pearson Education, Inc.

There are six steps that are used to perform a cause-and-effect analysis. These are

Step 1. Identify the problem to analyze its technical cause.

Step 2. Select an interdisciplinary brainstorm team.

Step 3. Draw a problem box and prime arrows.

Step 4. Specify major categories contributing to the problem.

Step 5. Identify a defect cause.

Step 6. Identify corrective action and perform the analysis in the same manner as for the cause and effect analysis.

Nancy R. Tague (2005, p. 248) has elaborated on the fishbone diagram as follows:

Description

The Fishbone Diagram identifies many possible causes for an effect or problem. It can be used to structure a brainstorming session. It immediately sorts ideas into useful categories.

When to use

- When identifying possible causes of a problem
- When the team's thinking tends to fall into ruts

Procedure

1. Agree on a problem statement (effect). Write it at the center right of the flipchart or whiteboard. Draw a box around it and draw a horizontal arrow running to it.
2. Brainstorm the major categories of causes of the problem. If there is difficulty here, use generic headings: method,

Serial No.	Name of Quality Tool	Usage
Tool 1	Pareto charts Ishikawa/fishbone diagrams	Used to identify the most significant cause or problem.
Tool 2		Charts of cause and effect in processes. Layer charts which place each set of data successively on top of the previous one. How is the data made up?
Tool 3	Stratification	
Tool 4	Check sheets	To provide a record of quality. How often it occurs?
Tool 5	Histogram	Graphs used to display frequency of various ranges of values of a quantity.
Tool 6	Scatter diagram	To determine whether there is a correlation between two factors.
Tool 7	Control charts	A device in statistical process control to determine whether or not the process is stable.

FIGURE 1.19
Seven tools of quality control.

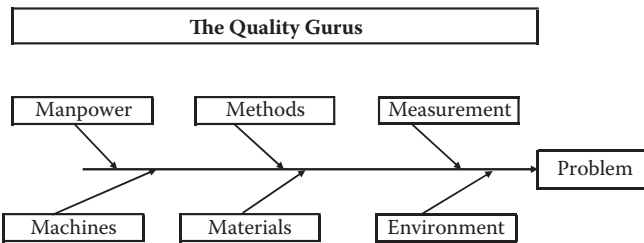

FIGURE 1.20
The Ishikawa fishbone diagram.

machines (equipment), people (manpower), materials, measurement, and environment. Write the categories of causes as branches from the main arrow.

3. Brainstorm all the possible causes of the problem. Ask “Why does this happen?” As each idea is given, the facilitator writes it as a branch from the appropriate category. Causes can be written in several places if they relate to several categories or multiple relationships.
4. Ask again, “Why does this happen?” about each cause. Write subcauses branching off the causes. Continue to ask “Why” and generate deeper levels of causes. Layers of branches indicate causal relationships.
5. When the team runs out of ideas, focus attention on places on the fishbone where ideas are few.

Summarizing Ishikawa's approach, it can be seen to contain both quantitative and qualitative aspects, which, taken together, focus on achieving companywide quality.

1.8.5 Joseph M. Juran

Juran's philosophy is perhaps best summed as "Quality does not happen by accident; it has to be planned."

The emphasis of Juran's work is on planning organizational issues, management's responsibility for quality, and the need to set goals and targets for improvement. Juran's definition of quality is "Fitness for use or purpose." His thinking on quality is an operational framework of three quality processes. These are

1. Quality planning
2. Quality control
3. Quality improvement

These are best known as Juran's quality trilogy.

Shtub, Bard, and Globerson (1994, p. 284) describe the Juran trilogy as follows:

- *Quality planning.* In preparing to meet organizational goals, the end result should be a process that is capable of meeting those goals under operating conditions. Quality planning might include identifying internal and external customers, determining customer needs, developing a product or service that responds to those needs, establishing goals that meet the needs of customers and suppliers at a minimum cost, and proving that the process is capable of meeting quality goals under operating conditions. A necessary step is for managers to engage cross-functional teams and openly supply data to team members so that they may work together with unity of purpose.
- *Quality control.* At the heart of this process is the collection and analysis of data for the purpose of determining how best to meet project goals under normal operating conditions. One may have to decide on control subjects, units of measurement, standards of performance, and degrees of conformance. To measure the difference between the actual performance before and after the process or system has been modified, the data should be statistically significant and the process or system should be in statistical control. Task forces working on various problems need to establish baseline data so that they can determine if the implemented recommendations are responsible for the observed improvements.
- *Quality improvement.* This process is concerned with breaking through to a new level of performance. The end result is that the

particular process or system is obviously at a higher level of quality in delivering either a product or a service.

Juran’s approach, like those of his colleagues, stresses the involvement of employees in all phases of a project. The philosophy and procedures require that managers listen to employees and help them rank the processes and systems that need improving.

Juran’s quality trilogy of planning control and improvement offers the guidelines for his approach. Figure 1.21 summarizes his steps on quality planning. Figure 1.22 illustrates the quality control procedure, whereas Table 1.8 summarizes Juran’s steps for continuous quality improvement

Step	Description
Step 1	Choose control subject
Step 2	Establish standards/objectives
Step 3	Monitor actual performance
Step 4	Compare objectives with achievements
Step 5	Take corrective action to reduce the differences

FIGURE 1.21

The quality control steps. (From J.M. Juran and A.B. Godfrey, *Juran’s Quality Handbook*, 1999. Reprinted with permission of The McGraw-Hill Companies.)

Step	Description
Step 1	Prove the need for quality improvement
Step 2	Identify project
Step 3	Set goals for continuous improvement
Step 4	Build a team to achieve goals by establishing a quality council, identifying problems, selecting a project, appointing teams and selecting facilitators
Step 5	Train team members
Step 6	Diagonize the causes
Step 7	Prepare report
Step 8	Formulate theories
Step 9	Provide remedial action
Step 10	Prove that the remedies are effective
Step 11	Deal with resistance to change
Step 12	Incorporate improvement into the company’s regular systems and processes and control to hold the gain

FIGURE 1.22

Steps to continuous quality improvement. (From J.M. Juran and A.B. Godfrey, *Juran’s Quality Handbook*, 1999. Reprinted with permission of The McGraw-Hill Companies.)

TABLE 1.8

The Quality Planning Steps

Step	Description
Step 1	Establish the project.
Step 2	Identify the customers.
Step 3	Identify the needs of those customers.
Step 4	Analyze and prioritize customer needs.
Step 5	Develop a product that can respond to customer needs.
Step 6	Optimize the product features so as to meet the organization's product range as well as customer needs.
Step 7	Identify process and goals.
Step 8	Develop a process that is able to produce the product.
Step 9	Optimize the process features and goals.
Step 10	Prove that the process can produce the product under operating conditions.
Step 11	Identify control needs.
Step 12	Transfer the process to operations.

1.8.6 John S. Oakland

Oakland's philosophy of quality is "We cannot avoid seeing how quality has developed into the most important competitive weapon, and many organizations have realized that TQM is the [sic] way of managing for the future (Oakland, 1993, Preface)." He gives absolute importance to the pursuit of quality as the cornerstone of organizational success.

Oakland's view is that "quality starts at the top," with quality parameters inherent in every organizational decision. He offers his own overarching approach for TQM on the many well-established methods, tools, and techniques for achieving quality, and some new insight. The overarching method is his "Ten Points for Senior Management." Figure 1.23 illustrates this.

Figure 1.24 illustrates Oakland's major features in his "Total Quality Management model."

1.8.7 Shigeo Shingo

Shingo's early philosophy embraced the "scientific management ideas" originated by Fredrick Taylor in the early part of the 20th century. Shingo believed that statistical methods detect error too late in the manufacturing process. He suggested that, instead of detecting errors, it was better to engage in preventative measures aimed at eliminating error sources. Shingo continues to believe in mechanizing the monitoring of error, considering that human assessment was "inconsistent" and prone to error and introduction of controls within a process. He used people to identify underlying causes and produce preventative solutions. Shingo has a clear belief, like Crosby, in a "zero defects" approach. His approach emphasizes zero defects through good engineering and process investigation and rectification.

Point 1	Long-term commitment.
Point 2	Change the culture to “right first time.”
Point 3	Train people to understand the customer–supplier relationship.
Point 4	Buy products and services on total cost
Point 5	Recognize that system improvement must be managed
Point 6	Adopt modern methods of supervision and training and eliminate fear
Point 7	Eliminate barriers, manage processes, improve communications and teamwork.
Point 8	Eliminate arbitrary goals, standards based only on numbers, barriers to pride of workmanship, fiction (use the correct tools to establish facts)
Point 9	Constantly educate and remain the in-house experts
Point 10	Utilize a systematic approach to TQM implementation

FIGURE 1.23

Ten points for senior management. (From J.S. Oakland, *TQM*, 2003. Reprinted with permission from Oakland Consulting PLC.)

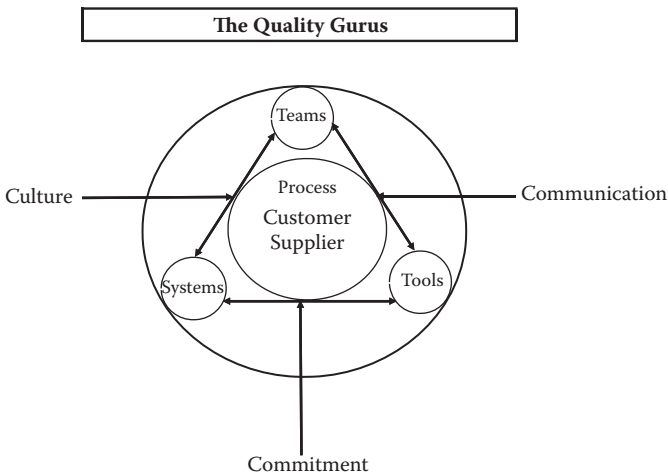

FIGURE 1.24

Total Quality Management model. (From J.S. Oakland, *TQM*, 2003. Reprinted with permission from Oakland Consulting PLC.)

Shingo is strongly associated with the “Just-in-Time” manufacturing philosophy. He was the inventor of the Single-Minute Exchange of Die (SMDE) system that drastically reduced the equipment setup time from hours to minutes. Just-in-Time is an integrated set of activities designed to achieve high-level volume production, with minimal inventories of parts that arrive at the workstation when they are needed.

Shingo is also associated with the Poka-Yoke system to achieve zero defects (failsafe procedures). The Poka-Yoke system includes checklists that (1) prevent workers from making an error that leads to defects before starting, or (2) gives rapid feedback of abnormalities in the process to the worker in time to correct them.

1.8.8 Genichi Taguchi

Taguchi's two founding ideas of quality work are essentially quantitative. The first is a statistical method to identify and eradicate quality problems. The second rests on designing products and processes to build in quality right from the outset.

Taguchi's prime concern is with customer satisfaction and with the potential for "loss of reputation and goodwill" associated with failure to meet customer expectation. Such a failure, he considered, would lead the customer to buy elsewhere in future, damaging the prospects of the company, its employees, and society. He saw that loss not only occurred when a product was outside its specification but also when it varied from its target value. Taguchi recognized the organization as "open system," interacting with its environment. The principal tools and techniques espoused by Taguchi center on the concept of continuous improvement and eradicating, as far as possible, potential causes of "nonquality" at the outset. His concept of product development has three stages:

1. System design stage
2. Parameter stage
3. Tolerance design stage

The first stage is concerned with system design reasoning involving both product and process. This framework is carried on to the second stage—parameter design. The third stage, tolerance design, enables the recognition of factors that may significantly affect the variability of the product.

1.8.9 Summary of Philosophies

Chase, Aquilano, and Jacob (2001) have compared the philosophies of three of our gurus—Crosby, Deming, and Juran. This comparison is listed in Table 1.9.

Table 1.10 illustrates the approaches of these quality gurus to quality improvements. Although there are differences in certain areas among these philosophers, all of them generally advocate the same steps.

Their emphasis is on customers satisfaction, management leadership, teamwork, continuous improvement, and minimizing defects.

TABLE 1.9
The Quality Gurus Compared

	Crosby	Deming	Juran
Definition of quality	Conformance to requirements	A predictable degree of uniformity and dependability at low cost and suited to the market	Fitness for use (satisfies customer's need)
Degree of senior management responsibility	Responsible for quality	Responsible for 94% of quality problems	Less than 20% of quality problems are due to workers
Performance standard/motivation	Zero defects	Quality has many "scales"; use statistics to measure performance in all areas; critical of zero defects	Avoid campaigns to do perfect work
General approach	Prevention, not inspection	Reduce variability by continuous improvement; cease mass inspection	General management approach to quality, especially human elements
Structure	14 steps to quality improvement	14 points for management	10 steps to quality improvement
Statistical process control (SPC)	Rejects statistically acceptable levels of quality (wants 100% perfect quality)	Statistically methods of quality control must be used	Recommends SPC but warns that it can lead to tool-driven approach
Improvement basis	A process, not a program; improvement goals	Continuous to reduce variation; eliminate goals without methods	Project-by-project team approach; set goals
Teamwork	Quality improvement teams, quality councils	Employee participation in decision making; break down barriers between departments	Team and quality circle approach
Costs of quality	Cost of nonconformance; quality is free	No optimum; continuous improvement	Quality is not free; there is no optimum
Purchasing and goals received	State requirements; supplier is extension of business; most faults due to purchasers themselves	Inspection too late; sampling allows defects to enter system; statistical evidence and control charts required	Problems are complex; carry out formal surveys
Vendor rating	Yes; quality audits useless	No; critical of most systems	Yes; but help supplier improve

Source: R. Chase, N. Aquilano, and F. Jacobs. (2001). *Operations Management*. Reprinted with permission of The McGraw-Hill Companies.

TABLE 1.10

Various Approaches to Quality Improvement

Deming's 14 Points for Management	Juran's 10 Steps to Quality Improvement	Crosby's 14 Steps to Quality Improvement
1. Create constancy of purpose for improvement of product and service.	1. Build awareness of the need and opportunity for improvement.	1. Make it clear that management is committed to quality.
2. Adopt the new philosophy.	2. Set goals for improvement.	2. Form quality improvement teams with representatives from each department.
3. Cease dependence on inspection to achieve quality.	3. Organize to reach the goals (establish a quality council, identify problems, select projects, appoint teams, designate facilitators).	3. Determine where current and potential quality problems lie.
4. End the practice of awarding business on the basis of price tag alone. Instead, minimize total cost by working with a single supplier.	4. Provide training.	4. Evaluate the cost of quality and explain its use as a management tool.
5. Improve constantly and forever every process for planning, production, an service.	5. Carry out projects to solve problems.	5. Raise the quality awareness and personal concern of all employees.
6. Institute training on the job.	6. Report progress.	6. Take actions to correct problems identified through previous steps.
7. Adopt and institute leadership.	7. Give recognition.	7. Establish a committee for the zero-defects program.
8. Drive out fear.	8. Communicate results.	8. Train supervisors to actively carry out their part of the quality improvement program.
9. Break down barriers between staff areas.	9. Keep score.	9. Hold a "zero-defects day" to let all employees realize that there has been a change.
10. Eliminate slogans, exhortations, and targets for the work force.	10. Maintain momentum by making annual improvement part of the regular systems and processes of the company.	10. Encourage individuals to establish improvement goals for themselves and their groups.

(Continued)

11. Eliminate numerical quotas for workmanship. Eliminate the annual rating or merit system.
 12. Remove barriers that rob people of workmanship. Eliminate the annual rating or merit system.
 13. Institute a vigorous program of education and self improvement for everyone.
 14. Put everybody in the company to work to accomplish the transformation.
11. Encourage employees to communicate to management the obstacles they face in attaining their improvement goals.
 12. Recognize and appreciate those who participate.
 13. Establish quality councils to communicate on a regular basis.
 14. Do it all over again to emphasize that the quality improvement program never ends.

Source: Kerzner, H. (2001). *Project Management: A Systems Approach to Planning, Scheduling and Controlling*. Reprinted with permission of John Wiley & Sons.

Based on these, the common features of their philosophies can be summarized as follows:

1. Quality is conformance to the customer's defined needs.
2. Senior management is responsible for quality.
3. Institute continuous improvement of process, product, and services through the application of various tools and procedures to achieve higher level of quality.
4. Establish performance measurement standards to avoid defects.
5. Take a team approach by involving every member of the organization.
6. Provide training and education to everyone in the organization.
7. Establish leadership to help employees perform a better job.

Thus, their concept of quality forms the basic tenets of TQM.

1.9 Total Quality Management

The Total Quality Management (TQM) concept was born following World War II. It was stimulated by the need to compete in the global market where higher quality, lower cost, and more rapid development are essential to market leadership. Today TQM is considered a fundamental requirement for any organization to compete, let alone lead, in its market. It is a way of planning, organizing, and understanding each activity of the process and removing all the unnecessary steps routinely followed in the organization. TQM is a philosophy that makes quality values the driving force behind leadership, design, planning, and improvement in activities. Table 1.11 summarizes periodical changes in the quality system.

1.9.1 Changing Views of Quality

Harold Kerzner (2001) states that, with the increased complexity of business, the cost of maintaining a meaningful level of quality had been steadily increasing. In order to reverse this trend, TQM is used to achieve a major competitive advantage. Kerzner has described this phenomenon: "During the past twenty years, there has been a revolution toward improved quality. The improvements have occurred not only in product quality, but also in quality leadership and quality project management." He further states:

TABLE 1.11

Periodical Changes in Quality System

Period	System
<ul style="list-style-type: none"> • Middle Ages (1200–1799) 	<ul style="list-style-type: none"> • Guilds-skilled craftsman were responsible to control their own products.
<ul style="list-style-type: none"> • Mid-18th century • Industrial Revolution 	<ul style="list-style-type: none"> • Establishment of factories. Increase in productivity. Mass production. Assembly lines. Several workers were responsible for producing a product. Production by skilled workers and quality audit by inspectors.
<ul style="list-style-type: none"> • Early 19th century • Late 19th century • 1880s • Beginning of 20th century • 1920s 	<ul style="list-style-type: none"> • Craftsmanship model of production. • Fredrick Taylor and “Scientific Management.” Quality management through inspection. • Walter Shewhart introduced Statistical Process Control. Introduction of full-time quality inspection and quality control department. Quality management.
<ul style="list-style-type: none"> • 1930s • 1950s • Late 1960s • 1970s 	<ul style="list-style-type: none"> • Introduction of sampling method. • Introduction of Statistical Quality Process in Japan. • Introduction of QA. • Total Quality Control. • Quality Management.
<ul style="list-style-type: none"> • 1980s • Beginning of 21st century 	<ul style="list-style-type: none"> • TQM. • Integrated Quality Management (IQM).

The push for higher levels of quality appears to be customer driven. Customers are now demanding

- Higher performance requirements
- Faster product developments
- Higher technology levels
- Materials and processes pushed to the limit
- Lower contractor profit managing
- Fewer defects/rejects. (p. 1083)

The changing views of quality appear in Table 1.12.

Gryna (2001, p. 3) has described the changing business conditions the organization should understand to survive in competitive world market. He says:

The prominence of product quality in the public mind has resulted in quality becoming a cardinal priority for most organizations. The identification of quality as a core concern has evolved through a number of changing business conditions. These include

1. Competition
2. The customer-focused organization
3. Higher levels of customer expectation
4. Performance improvement
5. Changes in organization forms

TABLE 1.12

Changing Views of Quality

Past	Present
<ul style="list-style-type: none"> • Quality is the responsibility of blue-collar workers and direct labor employees working on the floor. • Quality defects should be hidden from customers (and possibly management). • Quality problems lead to blame, faulty justification, and excuses. • Corrections to quality problems should be accomplished with minimum documentation. • Increased quality will increase project costs. • Quality is internally focused. • Quality will not occur without close supervision of people. • Quality occurs during project execution. 	<ul style="list-style-type: none"> • Quality is everyone's responsibility, including that of white-collar workers, the indirect labor force, and the overhead staff. • Defects should be highlighted and brought to the surface for corrective action. • Quality problems lead to cooperative solutions. • Documentation is essential for "lessons learned" so that mistakes are not repeated. • Improved quality saves money and increases business. • Quality is customer focused. • People want to produce quality products. • Quality occurs at project initiation and must be planned for within the project.

Source: Kerzner, H. (2001). *Project Management*. Reprinted with permission of John Wiley & Sons.

6. Changing workforce
7. Information revolution
8. Electronic commerce
9. Role of a quality department

The failure to address the culture of an organization is frequently the reason for management initiatives either having limited success or failing altogether. To understand the culture of the organization and using that knowledge to implement cultural change is an important element of TQM. The culture of good teamwork and cooperation at all levels in an organization is essential to the success of TQM. Table 1.13 describes cultural changes needed in an organization to meet Total Quality Management.

Juran (Juran and Godfrey, 1999) described the introduction of TQM as follows:

In the past two decades many organizations throughout the world have been under tremendous pressure. Some have been battered by international competition, others by new entrepreneurial companies that redefined business, and yet others were seriously challenged by new technologies which created formidable alternatives to their products and services. Some leading companies have changed rapidly. While some of the new companies have now become major players, other companies are still engaged in daily battles of survival, and many other companies have disappeared.

TABLE 1.13

Cultural Changes Required to Meet TQM

From	To
• Inspection orientation	• Defect prevention
• Meet the specification	• Continuous improvement
• Get the product out	• Customer satisfaction
• Individual input	• Cooperative efforts
• Sequential engineering	• Team approach
• Quality control department	• Organizational involvement
• Departmental responsibility	• Management commitment
• Short-term objective	• Long-term vision
• People as cost burden	• Human resources as an asset
• Purchase of products or services on price-alone basis	• Purchase on total cost minimization basis
• Minimum cost suppliers	• Mutual beneficial supplier relationship

Many companies have found that all of their restructuring, reengineering, downsizing and numerous quality programs may have helped them survive, but they still do not have a distinctive quality advantage. Their future will be determined by key areas: alignment, linkage and replication. Combined with the fundamental concepts of quality management (continuous improvement, customer focus and the value of every member of the organization), their work in these three key areas is transforming the way they are managing the entire organization.

During these years, there has been an increasing global emphasis on quality management. In global competitive markets, quality has become the most important single factor for success. Quality management has become the competitive issue for many organizations.

Juran has gone so far as to state that “just as the twentieth century was the century for productivity, the twenty-first century will be the quality century” (p. 14.2).

1.9.2 Principles of Total Quality Management

Juran describe TQM in terms of the Juran Trilogy, which involves quality planning, quality control, and quality improvement.

In JUSE’s (Japanese Union of Scientists and Engineers) view, as mentioned by Juran (Juran and Godfrey, 1999, p. 14.3),

TQM is a management approach that strives for the following in any business environment:

- Under strong top management leadership established clear mid and long-term vision and strategies.
- Properly utilize the concepts, values and scientific methods of TQM.
- Regard human resources and information as vital organizational infrastructures.

- Under an appropriate management system, effectively operate a quality assurance system and other cross-functional management systems such as cost, delivery, environment and safety.
- Supported by fundamental organizational powers, such as core technology, speed and vitality, ensure sound relationship with customers, employees, society suppliers and stockholders.
- Continuously release corporate objectives in the form of achieving an organization's mission, building an organization with a respectable presence and continuously securing profits.

According to ASQ,

Total Quality Management (TQM) is a management approach centered on quality, based on organization-wide participation, and aimed at long-term success through customer satisfaction.

TQM focuses on customers, both internal (within the organization, the next party in the work process) and external (end users, stakeholders, regulatory agencies).

Given the fluctuating nature of customer satisfaction, continuous improvement is critical to an organization's survival. The concept applies to processes and the people who operate them as well as products.

The plan-do-check-act (PDCA) cycle is a well-known model for continuous process improvement. The four-step process is also referred to as the Shewhart cycle (for Walter A. Shewhart), the Deming cycle (for W. Edwards Deming), and the PDSA cycle (with the S standing for "Study"). First, a plan to effect improvement is developed. Next, the plan is carried out, preferably on a small scale. Then effects of the plan are observed. Last results are studied to determine what was learned and what can be predicted.

TQM's emphasis on participation recognizes that every activity contributes to or detracts from quality and productivity. Leadership from management and employee involvement is crucial for success.

Management's role in TQM is to develop a quality strategy aligned with organizational business objectives and based on customer and stakeholder needs. After that strategy is defined, managers must participate in its deployment regularly and at every level.

Employee involvement can take several forms. Typically, quality improvement requires teams involving employees across functional boundaries. When employees are involved in quality, their organizations are more likely to make well-informed quality decisions and feel responsible for those decisions. Organizations empower employees by allowing them to make decisions that improve work process within defined boundaries.

TQM focuses on participative management and strong operational accountability at the individual contributor level. Total quality involves not just managers but everyone in the organization in a complete transformation of the prevailing culture. It is a change to the way people do things, and relies on trust between managers and staff. TQM is applicable to all kinds of organizations, both in the public and private sector. It is also applicable

to those providing services as well as those involved in producing goods or manufacturing activities. Figure 1.25 shows the basic components of TQM.

Jiju Anthony and David Preece (2001) have linked TQM and performance as a strategic perspective toward competitive advantage. They have quoted Frangon et al. (1999) that “quality as a means of creating and sustaining a competitive advantage has been widely adopted by both public and private sector organization” (p. 4).

They further state that “to improve quality, businesses have applied ‘Total Quality Management’ (TQM) to their organizations to help them plan their efforts. The promise of superior performance through continuous quality improvement has attracted a wide spectrum of businesses to TQM, with applications reported in domains such as finance (Wilkinson et al., 1996), utilities (Candlin and Day, 1993), federal agencies, healthcare, education and research, environment and manufacturing (Lakhe and Mohanty, 1994)” (p. 4).

According to Construction Industry Institute (CII) source document 74: “Total Quality Management is often termed a journey, not a destination.” This is because of its nature as a collection of improvement-centered processes and techniques that are performed in a transformed management environment. The concept of “continuous improvement” holds that this environment must prevail for the life of the enterprise and that the methods will routinely be used on a regular, recurring basis. The improvement process never ends; therefore, no true destination is ever reached. Figure 1.26 describes the phases of the TQM journey.

The document further states (p. 1) that from the viewpoint of the individual company, the strategic implications of TQM include

- Survival in an increasingly competitive world
- Better service to the customer
- Enhancement of the organization’s “shareholder value”
- Improvement of the overall quality and safety of our facilities
- Reduced project duration and costs
- Better utilization of talents of the people

Chase, Aquilano, and Jacobs (2001) have defined TQM as

Managing the entire organization so that it excels on all dimensions of products and services that are important to the customer. This definition is more applicable than another commonly used one—‘Conformance to specifications.’ Though valid for goods production, the second definition is problematic for many services. Precise specifications for service quality are hard to define and measure. It is possible, however to find out what’s important to the customer and then create the kind of organizational culture that motivates and enables the worker to deliver a quality service.

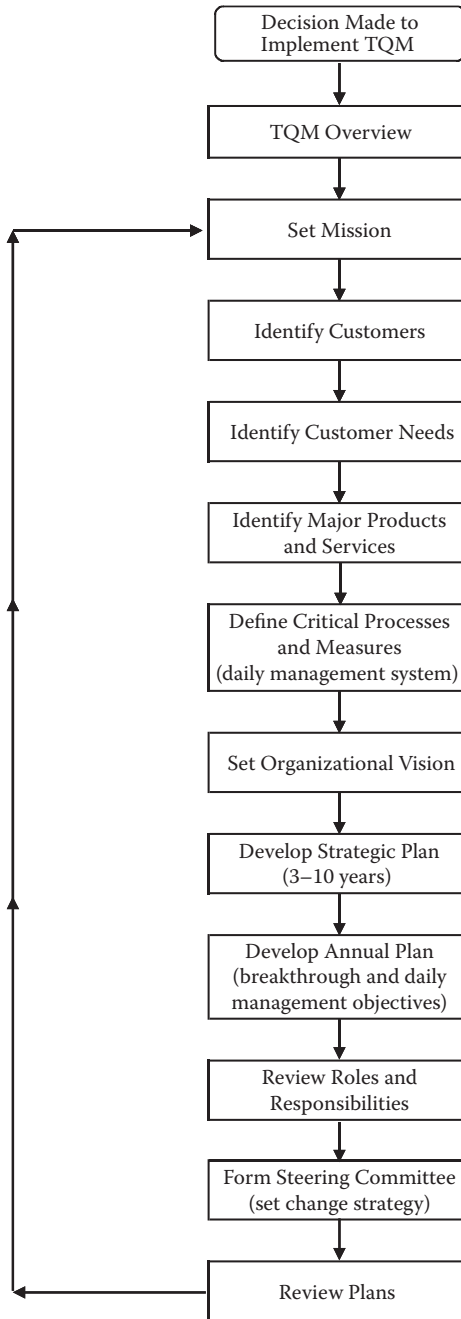
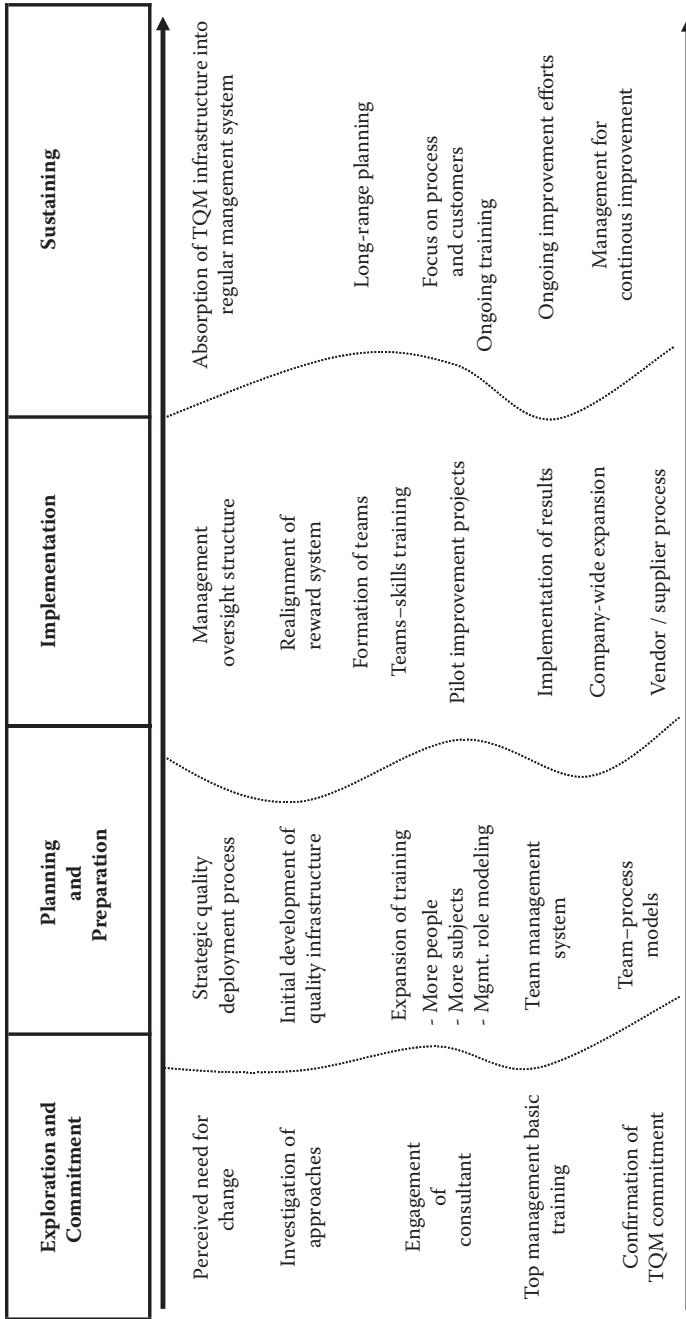

FIGURE 1.25

Basic components of TQM. (From A. Shtub, J.F. Bard, and S. Globerson, *Project Management*, 1994. Reprinted with permission from Pearson Education, Inc.)



Note:- Phase boundaries are not sharply defined in time.
Read top to bottom, then left to right.

FIGURE 1.26 Phases of the TQM journey. (From CII Source document 74. Reprinted with permission of CII, University of Texas.)

They further state:

The philosophical elements of TQM stress the operation of the firm using quality as the integrating element. The generic tools consist of (1) various statistical process control (SPC) methods that are used for problem solving and continuous improvement by quality terms, and (2) quality function deployment, which is typically used by managers to drive the voice of the customer into the organization. (p. 260)

Figure 1.27 illustrates the elements of TQM.

An ISO document has listed eight quality management principles on which the quality management system standards of the revised ISO 9000:2000 series are based. These are as follows:

- Principle 1—Customer focus
- Principle 2—Leadership
- Principle 3—Involvement of people
- Principle 4—Process approach
- Principle 5—System approach to management
- Principle 6—Continual improvement
- Principle 7—Factual approach to design making
- Principle 8—Mutual beneficial supplier relationship

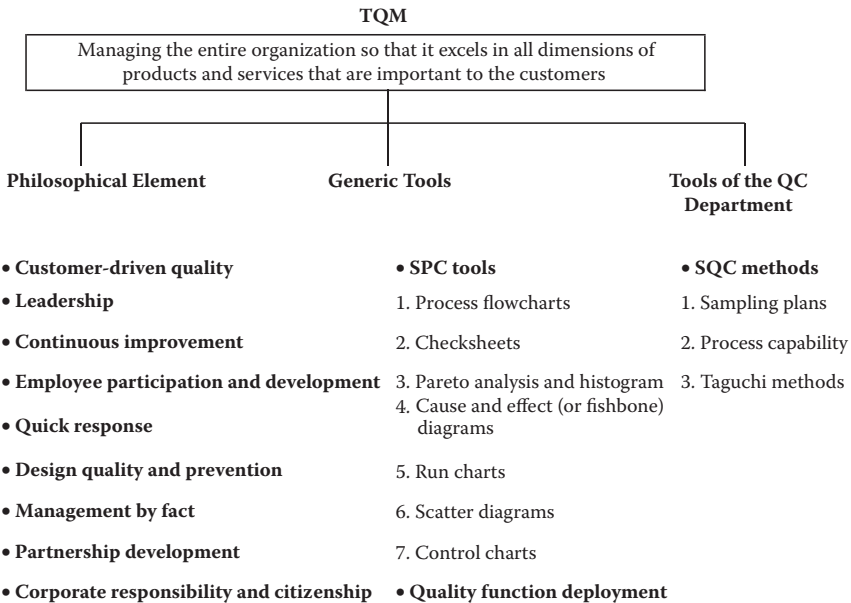

FIGURE 1.27 Elements of TQM. (From R. Chase, N. Aquilano, and F. Jacobs, *Operations Management*, 2001. Reprinted with permission of The McGraw Hill Companies.)

Based on those principles, it can be summarized that TQM is a management philosophy that evolved in Japan after World War II. It places quality as a strategic objective and focuses on continuous improvement of products, processes, services, and cost to compete in the global market by minimizing rework, and maximizing profitability to achieve market leadership and customer satisfaction. It is a way of managing people and business processes to meet customer satisfaction. TQM involves everyone in the organization in the effort to increase customer satisfaction and achieve superior performance of the products or services through continuous quality improvement. TQM helps in

- Achieving customer satisfaction
- Continuous improvement
- Developing teamwork
- Establishing vision for the employees
- Setting standards and goals for the employees
- Building motivation within the organization
- Developing corporate culture

TQM is widely accepted as the basis for achieving sustainable competitive advantage. It is required to achieve customer satisfaction and ensure survival in the competitive world because of the global nature of competition, which never rests, and there is no end to product or service improvement.

1.10 Quality Function Deployment

Quality function deployment (QFD) is a technique for translating customer requirements into technical requirements. It was developed in Japan by Dr. Yoji Akao in the 1960s to transfer the concepts of quality control from the manufacturing process into the new product development process. QFD is referred to as the “voice of the customer,” which helps in identifying and developing customer requirements through each stage of product or service development. It is a development process that utilizes a comprehensive matrix involving project team members.

QFD is being applied virtually in every industry and business—from aerospace, communication, and software to transportation, manufacturing, services, and construction. QFD helps in constructing one or more matrices containing information related to others. The assembly of several matrices showing correlation with one another is called “the house of quality” and is the most recognized form of QFD. The house of quality is made up of following major components:

1. WHAT
2. HOW
3. Correlation matrix (Roof)—technical requirements
4. Interrelationship matrix
5. Target value
6. Competitive evaluation

Figure 1.28 illustrates the basic house of quality.

The WHAT is the first step in developing the house of quality. It is a structured set of needs/requirements ranked in terms of priority and the levels of importance being specified quantitatively. It is generated by using questions such as

- What types of finishes are needed for the building?
- What type of air-conditioning system is required for the building?
- What type of communication system is required for the building?
- What type of flooring material is required?
- Does the building need a security system?

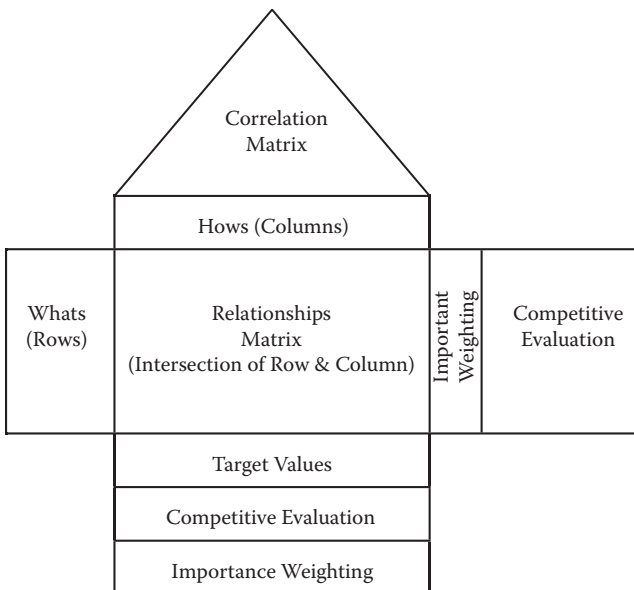

FIGURE 1.28

The house of quality. (From T. Pyzdek, *Quality Engineering Handbook*, 1999. Reprinted with permission from Quality America, Inc.)

The HOW is the second step in which project team members translate the requirements (WHAT) into technical design characteristics (specifications) and are listed across the columns of the matrix.

The correlation matrix identifies the technical interaction or physical relationship among the technical specifications. The interrelationship matrix illustrates team members' perceptions of the interrelationship between owner's requirements and technical specifications.

The bottom part allows for technical comparison between possible alternatives, target values for each technical design characteristic, and performance measurement.

The right side of the house of quality matrix is used for planning. It illustrates customer perceptions observed in the market survey.

The QFD technique can be used to translate the owner's need/requirements into developing a set of technical requirements during conceptual design.

Figure 1.29 illustrates the house of quality for a smart building system.

1.11 Six Sigma

1.11.1 Introduction

Six Sigma is, basically, a process quality goal. It is a process quality technique that focuses on reducing variation in the process and preventing deficiencies in the product. In a process that has achieved Six Sigma capability, the variation is small compared to the specification limits.

Sigma is a Greek letter, σ , standing for standard deviation. Standard deviation is a statistical way to describe how much variation exists in a set of data, a group of items, or a process. Standard deviation is the most useful measure of dispersion. Six Sigma means that, for a process to be capable at the Six Sigma level, the specification limits should be at least 6σ from the average point. So, the total spread between the upper specification (control) limit and the lower specification (control) limit should be 12σ . With Motorola's Six Sigma program, no more than 3.4 defects per million fall outside the specification limits with a process shift of not more than 1.5σ from the average or mean. Six Sigma started as a defect reduction effort in manufacturing and was then applied to other business processes for the same purpose.

Six Sigma is a measurement of "goodness" using a universal measurement scale. Sigma provides a relative method to measure improvement. Universal means sigma can measure anything from coffee mug defects to missed chances to close a sales deal. It simply measures how many times a customer's requirements were not met (a defect), given a million opportunities. Sigma is measured in defects per million opportunities (DPMO). For

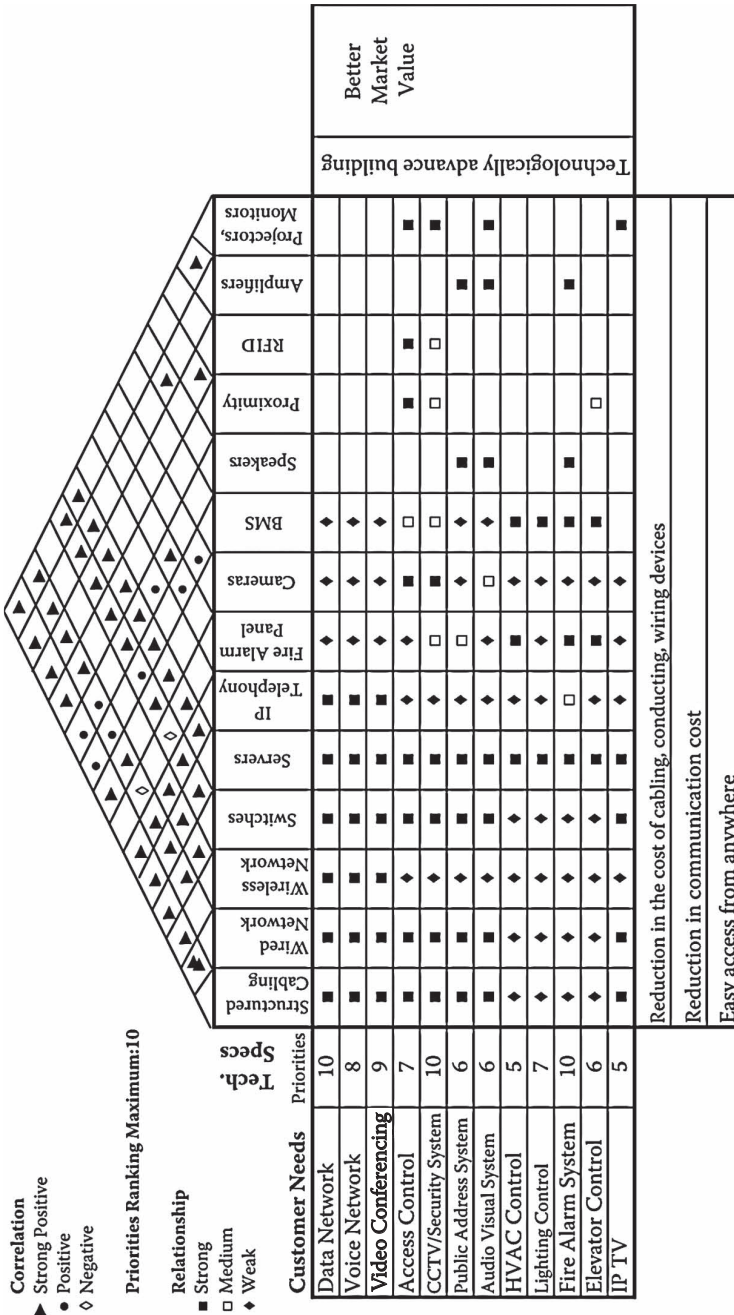

FIGURE 1.29
The house of quality for smart building system.

example, a level of sigma can indicate how many defective coffee mugs were produced when one million were manufactured. Levels of sigma are associated with improved levels of goodness. To reach a level of Three Sigma, you can only have 66,811 defects, given a million opportunities. A level of Five Sigma only allows 233 defects. Minimizing variation is a key focus of Six Sigma. Variation leads to defects, and defects lead to unhappy customers. To keep customers satisfied, loyal, and coming back, you have to eliminate the sources of variation. Whenever a product is created or a service performed, it needs to be done the same way every time, no matter who is involved. Only then will you truly satisfy the customer. Figure 1.30 illustrates the Six Sigma roadmap.

1.11.2 Six Sigma Methodology

Six Sigma is an overall business improvement methodology that focuses an organization on

- Understanding and managing customer requirements
- Aligning key business process to achieve these requirements
- Utilizing rigorous data analysis to minimize variation in these processes
- Driving rapid and sustainable improvement in the business process by reducing defects, cycle time, impact to the environment, and other undesirable variations
- Timely execution

As a management system, Six Sigma is a high-performance system for executing business strategy. It uses the concept of facts and data to drive better solutions. Six Sigma is a top-down solution to help organizations

- Align their business strategy to critical improvement efforts
- Mobilize teams to attack high-impact projects
- Accelerate improved business results
- Govern efforts to ensure that improvements are sustained

Six Sigma methodology also focuses on

- Leadership principles
- Integrated approach to improvement
- Engaged teams
- Analytic tool
- Hard-coded improvements

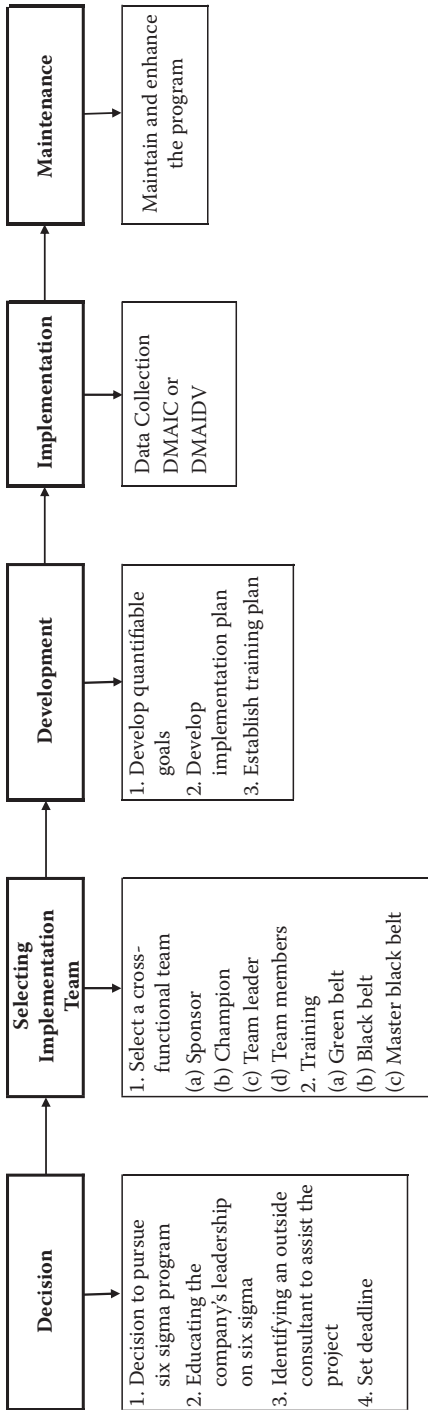

FIGURE 1.30
Six Sigma roadmap.

1.11.2.1 Leadership Principles

The Six Sigma methodology has four leadership principles. These are

1. Align
2. Mobilize
3. Accelerate
4. Govern

Brief descriptions of these leadership principles follows.

Align: Leadership should ensure that all improvement projects are in line with the organization's strategic goals.

Alignment begins with the leadership team developing a scorecard. This vital tool, the cornerstone of the Six Sigma business improvement campaign, translates strategy into tactical operating terms. The scorecard also defines the metrics an organization can use to determine success. Just as a scoreboard at a sporting event tells you who is winning, the scorecard tells the leadership how well the company is meeting its goals.

Mobilize: Leadership should enable teams to take action by providing clear direction, feasible scope, a definition of success, and rigorous reviews.

Mobilizing sets clear boundaries, lets people go to work, and trains them as required. The key to mobilizing is focus; lack of focused action was one of the downfalls of previous business improvement efforts. True focus means the project is correctly aligned with the organization's scorecard. Mobilized teams have a valid reason for engaging in improvement efforts—they can see benefit for the customer. The project has strategic importance, and they know it. They know exactly what must be done and the criteria they can use to determine success.

Accelerate: Leadership should drive a project to rapid results through tight clock management, training as needed, and shorter deadlines.

More than 70% of all improvement initiatives fail to achieve desired results in time to make a difference. For projects to make an impact, they must achieve results quickly, and that is what acceleration is all about.

The accelerate leadership principle involves three main components:

1. Action learning
2. Clock management
3. Effective planning

Accelerate employs the “action learning” methodology to quickly bridge from “learning” to “doing.” Action learning mixes traditional training with direct application. Training is received while working on a real-world project, allowing plenty of opportunity to apply new knowledge. The instructor is not simply a trainer but a coach as well, helping with work on the real-world

project. Action learning accelerates improvement over traditional learning methods. It helps in receiving training and also completing a worthwhile project at the same time. In addition to the four-to-six-month time frame, accelerate requires teams to set deadlines that are reinforced through rigorous reviews.

Govern: Leadership must visibly sponsor projects and conduct regular and rigorous reviews to make critical midcourse corrections.

Once the leaders select an improvement opportunity, their work is not done. They must remain ultimately responsible for the success of that project. Govern requires leaders to drive for results.

While governing a Six Sigma project, you need

- A regular communications plan and a clear review process
- To actively sponsor teams and their projects
- To encourage proactive dialogue and knowledge sharing in the team and throughout the organization

1.11.2.2 Six Sigma Team

Teamwork is absolutely vital for complex Six Sigma projects. For teams to be effective, they must be engaged—involved, focused, and committed to meeting their goals. Engaged teams must have leadership support. There are four types of teams:

1. Black Belt
2. Green Belt
3. Breakthrough
4. Blitz

These are briefly described next.

1.11.2.2.1 Black Belt

Black Belt teams are led by a Black Belt, and may have Green Belts and functional experts assigned to complex, high-impact process improvement projects or to designing new products, services, or complex processes. Black Belts are internal Six Sigma practitioners, skilled in the application of rigorous statistical methodologies, and they are crucial to the success of Six Sigma. Their additional training and experience provide them with the skills they need to tackle difficult problems. The responsibilities of Black Belts are to

- Function as Team Leader on Black Belt projects
- Integrate their functional discipline with statistical, project, and interpersonal skills
- Serve as internal consultants

- Tackle complex, high-impact improvement opportunities
- Mentor and train Green Belts

1.11.2.2.2 *Green Belt*

Led by a Green Belt and comprised of nonexperts, Green Belt teams tackle less complex, high-impact process improvement projects. Green Belt teams are often coached by Black Belts or Master Black Belts.

Green Belts are also essential to the success of Six Sigma. They perform many of the same functions as Black Belts, but their work requires less complex analysis. Green Belts are trained in basic problem-solving skills and the statistical tools needed to work effectively as members of process improvement teams.

Green Belt responsibilities include

- Acting as Team Leader on business improvements requiring less complex analysis
- Adding their unique skills and experiences to the team
- Working with the team to come up with inventive solutions
- Performing basic statistical analysis
- Conferring with a Black Belt as questions arise

1.11.2.2.3 *Breakthrough*

While creating simple processes, sophisticated statistical tools may not be needed. Breakthrough teams are typically used to define low-complexity, new processes.

1.11.2.2.4 *Blitz*

Blitz teams are put in place to quickly execute improvements produced by other projects. These teams can also implement digitization for efficiency using a new analytic tool set.

For a typical Six Sigma project, four critical roles exist:

1. Sponsor
2. Champion
3. Team Leader
4. Team member

A Sponsor typically

- Remains ultimately accountable for a project's impact
- Provides project resources
- Reviews monthly and quarterly achievements, obstacles, and key actions
- Supports the project Champion by removing barriers as necessary

A Champion typically

- Reviews weekly achievements, obstacles, and key actions
- Meets with the team weekly to discuss progress
- Reacts to changes in critical performance measures as needed
- Supports the Team Leader, removing barriers as necessary
- Helps ensure project alignment

A Team Leader typically

- Leads improvement projects through an assigned, disciplined methodology
- Works with the Champion to develop the Team Charter, review project progress, obtain necessary resources, and remove obstacles
- Identifies and develops key milestones, timelines, and metrics for improvement projects
- Establishes weekly, monthly, and quarterly review plans to monitor team progress
- Supports the work of team members as necessary

Team members typically

- Assist the Team Leader
- Follow a disciplined methodology
- Ensure that the Team Charter and timelines are being met
- Accept and execute assignments
- Add their views, opinions, and ideas

1.11.3 Analytic Tool Sets

The following are the analytic tools used in Six Sigma projects:

1. Ford Global 8D Tool

D1: Establish the team

D2: Describe the problem → What Problem Needs Solving?

Who should help solve problem?

How do we quantify symptoms?

D3: Implement and verify containment → How do we contain it?

D4: Identify and verify root causes → What is the root cause?

D5: Choose and verify corrective action → What is the permanent corrective action?

D6: Implement and validate permanent corrective action → How do we implement?

D7: Prevent recurrence → How can we prevent this in future?

D8: Congratulate the team → Who should we reward?

The Ford Global 8D Tool is primarily used to bring performance back to a previous level.

2. DMADV Tool Set Phases

Define → What is important?

Measure → What is needed?

Analyze → How will we fulfill?

Design → How do we build it?

Verify → How do we know it will work?

The DMADV tool is used primarily for the invention and innovation of modified or new products, services, or process. Using this tool set, Black Belts optimize performance before production begins. DMADV is proactive, solving problems before they start. This tool is also called DFSS (Design for Six Sigma).

3. DMAIC Tool

Define → What is important?

Measure → How are we doing?

Analyze → What is wrong?

Improve → What needs to be done?

Control → How do we guarantee performance?

The DMAIC tool refers to a data-driven quality strategy and is used primarily for improvement of an existing product, service, or process.

4. DMADDD Tool

Define → Where must we be leaner?

Measure → What's our baseline?

Analyze → Where can we free capacity and improve yields?

Design → How should we implement?

Digitize → How do we execute?

Drawdown → How do we eliminate parallel paths?

The DMADDD tool is primarily used to drive the cost out of a process by incorporating digitization improvements. These improvements can drive efficiency by identifying non-value-added tasks and use simple Web-enabled tools to automate certain tasks and improve efficiency. In doing so, employees can be freed up to work on more value-added tasks.

Table 1.14 lists the fundamental objectives of DMADV, DMAIC, and DMADDD.

1.11.3.1 The DMAIC Process

The majority of the time, Black and Green Belts approach their projects with the DMAIC analytic tool set, driving process performance to never-before-seen levels.

TABLE 1.14

Fundamental Objectives of Six Sigma Tools

Tool	Phase	Fundamental Objective
DMADV		
1.	Define —What is important?	Define the project goals and customer deliverables (internal and external)
2.	Measure —What is needed?	Measure and determine customer needs and specifications
3.	Analyze —How will we fulfill?	Analyze process options and prioritize based on capabilities to satisfy customer requirements
4.	Design —How do we build it?	Design detailed processes capable of satisfying customer requirements
5.	Verify —How do we know it will work?	Verify design performance capability
DMAIC		
1.	Define —What is important?	Define the project goals and customer deliverables (internal and external)
2.	Measure —How are we doing?	Measure the process to determine current performance
3.	Analyze —What is wrong?	Analyze and determine the root causes of the defects
4.	Improve —What needs to be done?	Improve the process by permanently removing the defects
5.	Control —How do we guarantee performance?	Control the improved process's performance to ensure sustainable results
DMADDD		
1.	Define —Where must we be learner?	Identify potential improvements
2.	Measure —What's our baseline?	Analog touch points
3.	Analyze —Where can we free capacity and improve yields?	Task elimination and consolidated ops Value-added/non-value-added tasks Free capacity and yield
4.	Design —How should we implement?	Future state vision Define specific projects Define drawdown timing Define commercialization plans
5.	Drawdown —How do we eliminate parallel paths?	Commercialize new process Eliminate parallel path

DMAIC has following fundamental objectives:

1. Define phase: Define the project and customer deliverables.
2. Measure phase: Measure the process performance and determine current performance.
3. Analyze: Collect, analyze, and determine the root causes of variation and process performance.
4. Improve: Improve the process by diminishing defects with alternative remedy.
5. Control: Control improved process performance.

The DMAIC process contains five distinct steps that provide a disciplined approach to improving existing processes and products through the effective integration of project management, problem solving, and statistical tools. Each step has fundamental objectives and a set of key deliverables, so the team member will always know what is expected of him or her and his or her team.

DMAIC stands for the following:

- Define opportunities
- Measure performance
- Analyze opportunity
- Improve performance
- Control performance

1.11.3.1.1 *Define Opportunities (What Is Important?)*

The objective of this phase is

- To identify and/or validate the improvement opportunities that will achieve the organization's goals and provide the largest payoff, develop the business process, define critical customer requirements, and prepare to function as an effective project team.

The key deliverables in this phase include

- Team charter
- Action plan
- Process map
- Quick win opportunities
- Critical customer requirements
- Prepared team

1.11.3.1.2 Measure Performance (How Are We Doing?)

The objectives of this phase are

- To identify critical measures that are necessary to evaluate success or failure, meet critical customer requirements, and begin developing a methodology to effectively collect data to measure process performance
- To understand the elements of the Six Sigma calculation and establish baseline sigma for the processes the team is analyzing

The key deliverables in this phase include

- Input, process, and output indicators
- Operational definitions
- Data collection format and plans
- Baseline performance
- Productive team atmosphere

1.11.3.1.3 Analyze Opportunity (What Is Wrong?)

The objectives of this phase are

- To stratify and analyze the opportunity to identify a specific problem and define an easily understood problem statement
- To identify and validate the root causes and thus the problem the team is focused on
- To determine true sources of variation and potential failure modes that lead to customer dissatisfaction

The key deliverables in this phase include

- Data analysis
- Validated root causes
- Sources of variation
- Failure modes and effects analysis (FMEA)
- Problem statement
- Potential solutions

1.11.3.1.4 Improve Performance (What Needs to Be Done?)

The objectives of this phase are

- To identify, evaluate, and select the right improvement solutions
- To develop a change management approach to assist the organization in adapting to the changes introduced through solution implementation

The key deliverables in this phase include

- Solutions
- Process maps and documentation
- Pilot results
- Implementation milestones
- Improvement impacts and benefits
- Storyboard
- Change plans

1.11.3.1.5 Control Performance (How Do We Guarantee Performance?)

The objectives of this phase are

- To understand the importance of planning and executing against the plan and determine the approach to be taken to ensure achievement of the targeted results
- To understand how to disseminate lessons learned, identify replication and standardization opportunities/processes, and develop related plans

The key deliverables in this phase include

- Process control systems
- Standards and procedures
- Training
- Team evaluation
- Change implementation plans
- Potential problem analysis
- Solution results
- Success stories
- Trained associates
- Replication opportunities
- Standardization opportunities

The Six Sigma methodology is not so commonly used in construction projects; however the DMAIC tool can be applied at various stages in construction projects. These are

1. Detailed design stage—To enhance coordination method in order to reduce repetitive work

2. Construction stage—Preparation of builder's workshop drawings and composite drawings, as it needs much coordination among different trades
3. Construction stage—Preparation of contractor's construction schedule
4. Execution of works

1.11.4 Six Sigma in Construction Projects

The contractor's construction schedule (CCS) is an important document used during the construction phase. It is used to plan, monitor, and control project activities and resources. The document is voluminous and important. It has to be prepared with accuracy in order to follow the work progress without deviation from the milestones set up in the contract documents. Generally the project interim payment to the contractor is linked to the approval of the CCS. The contractor is not paid unless the CCS is approved by the construction manager/project manager/consultant.

In most cases, contractors experience problems with getting the CCS approved, at the very first submission, from the construction manager/project manager/consultant. It could be rejected if it does not meet the specifications. Therefore, the contractor has to put all effort into collecting relevant data to be fed to develop the CCS.

1.11.4.1 The DMADV Process

The following is an example procedure to develop the CCS using the Six Sigma DMADV analytic tool set. The DMADV method is used primarily for the invention of modified or new products, services, or processes. DMADV stands for

1. Define—What is important?
2. Measure—What is needed?
3. Analyze—How will we fulfill?
4. Design—How do we build?
5. Verify—How do we know it will work?

1.11.4.1.1 Define Phase (What Is Important?)

The objective of this phase is to define the project goals and customer deliverables

The key deliverables of this phase are

- Establish the goal
- Identify the benefits
- Select project team
- Develop project plan

Goal: Develop CCS using Six Sigma tools.

Benefits: The measurable benefits in adopting this process will result in CCS that will meet all the requirements of the specifications and shall be approved by the construction manager/project manager/consultant at the first submission itself. This will reduce the repetitive work and help implement the schedule right from the early stage of the project.

Selection of team: The team shall consist of

- a. Sponsor—Project Manager
- b. Champion—Construction Manager
- c. Team Leader—Planning and Control Manager
- d. Team Members—Planning Engineer, Cost Engineer, and one representative from each subcontractor

Project plan: Time frame in the form of the Gantt chart shall be prepared to meet the target dates for submitting the contractor's construction schedule (CCS).

1.11.4.1.2 Measure Phase (What Is Needed?)

The objective of this phase is to measure and determine customer needs and specifications

The key deliverable in this phase is

- Identify specification requirements

The following are the requirements listed in most contract documents.

The contractor has to submit the construction schedule in a bar chart time-scaled format to show the sequence and interdependence of activities required for complete performance of all items of work under the contract. The contractor shall use a computerized precedence diagram critical path method (CPM) technique in preparation of CCS. The schedule shall include, but not be limited to, the following:

1. Project site layout.
2. Concise description of the work.
3. Milestones (contractual milestones or constraints).
4. Number of working days.
5. Work breakdown structure (WBS) activities shall consist of all those activities that take time to carry out execution/installation and on which resources are expended.
6. Construction network of project phases (if any), including various subphases.

7. Construction network of the project arrangements (activities) and sequence.
8. Time schedules for various activities in a bar chart format.
9. The minimum work activities to be included in the program shall include items stated in the bill of quantity (BOQ).
10. WBS activities shall consists of all those activities that take time to carry out execution/installation and on which resources are expended.
11. Early and late finish dates.
12. Time schedule for critical path.
13. Schedule text report showing activity, start and finish dates, total float, and relationship with other activities.
14. Summary schedule report showing number of activities, project start, project finish, number of relations, open ends, constraints, and milestone.
15. Total float of each activity.
16. Cost loading.
17. Expected progress cash flow S-curve.
18. Resource-loaded S-curve.
19. Manpower loading.
20. Labor and crew movement and distribution.
21. Resource productivity schedule.
22. The number of hours per shift.
23. Average weekly usage of manpower for each trade.
24. Resource histogram showing the manpower required for different trades per time period for each trade (weekly or monthly).
25. Equipment and machinery loading.
26. Schedule of mobilization and general requirements.
27. Schedule of subcontractor's and suppliers' submittal and approval.
28. Schedule of materials submittals and approvals.
29. Schedule of long lead materials.
30. Schedule of procurement.
31. Schedule of shop drawings submittals and approvals.
32. Regulatory/authorities' requirements.
33. Schedule of testing, commissioning, and handover
34. Expected cash flow for executed work (during progress of work).

1.11.4.1.3 Analyze Phase (How Will We Fulfill?)

The objective of this phase is to analyze process options and prioritize based on capability to satisfy customer requirements.

The key deliverables in this phase are

- Data collection
- Prioritization of data under major variables

Data collection: The objective of this process are to

1. Identify milestone dates and constraints
2. Identify project calendar
3. Identify resource calendar
4. Review contract conditions and technical specifications
5. Identify mobilization requirements
6. Identify project method statement
7. Identify subcontractors/suppliers
8. Identify materials requirements
9. Identify long lead items
10. Identify procurement schedule
11. Identify shop drawing requirements
12. Identify regulatory/authorities' requirements
13. Identify WBS activities using BOQ
14. Relate WBS activities with BOQ and contract drawings
15. Identify zoning/phasing
16. Identify codes for all activities per contract document divisions/sections per the Construction Specifications Institute (CSI) format
17. Identify volume of work for each activity
18. Identify duration/time schedule of each activity
19. Identify early and late finish dates
20. Identify critical activities and its effect on critical path
21. Identify logical relationship
22. Identify sequencing of activities
23. Identify project progress cash flow (work in place)
24. Identify manpower resources with productivity rate
25. Identify equipment and machinery

26. Identify project constraints such as access, logistics, delivery, seasonal, national, safety, existing work flow discontinuity, and proximity of adjacent concurrent work
27. Identify testing, commissioning, and handover requirements
28. Identify special inspection requirements
29. Identify closeout requirements
30. Identify and include items not listed in the specifications but are important for project scheduling
31. Identify suitable software program
32. Identify submittal requirements

Arrangement of data: The generated data can be prioritized in an orderly arrangement under the following major variables:

1. Milestones
2. WBS activities
3. Time schedule
4. General requirements
5. Resources
6. Engineering
7. Cost loading

Figure 1.31 illustrates these variables along with related subvariables arranged in the form of the Ishikawa diagram.

1.11.4.1.4 Design Phase (How Do We Build It?)

The objective of this phase is to design detailed processes capable of satisfying customer requirements.

The key deliverable in this phase is

- Preparation of program using suitable (specified) software program

The Project and Control Manager can prepare the CCS based on the collected data and sequence of activities.

1.11.4.1.5 Verify Phase (How Do We Know It Will Work?)

The objective of this phase is to verify design performance capability

The key deliverables in this phase are

- Review the schedule by the team members to ascertain that all the required elements are included for compliance with specification requirements.
- Submit CCS to Construction Manager/Project Manager/Consultant.
- Update the schedule as and when required.

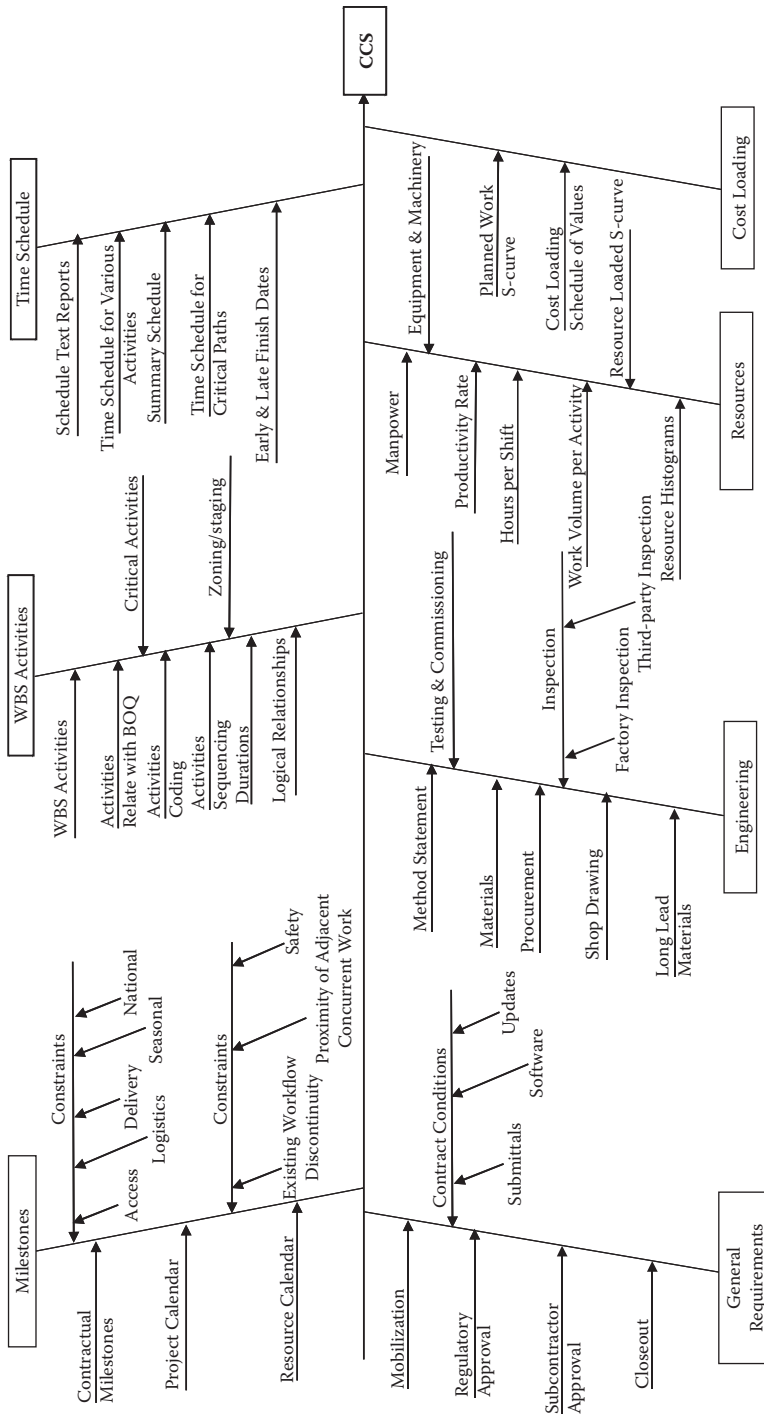

FIGURE 1.31 Ishikawa diagram for CCS data.

1.12 TRIZ

TRIZ is short for *teirija rezhenijia izobretalenksh zadach* (“theory of inventive problem solving”), developed by the Russian scientist Genrish Altshuller. TRIZ provides systematic methods and tools for analysis and innovative problem solving to support the decision-making process.

Continuous and effective quality improvement is critical to the organization’s growth, sustainability, and competitiveness. The cost of quality is associated with both chronic and sporadic problems. Engineers are required to identify and analyze the causes and solve these problems by applying various quality improvement tools. Any of these quality tools taken individually does not allow a quality practitioner to carry out the whole problem-solving cycle. These tools are useful for solving a particular phase of the problem and need a combination of various tools and methods to find the solution.

TRIZ is an approach that starts at a point where fresh thinking is needed to develop a new process or redesign an existing one. It focuses on a method for developing ideas to improve a process, get something done, design a new approach, or redesign an existing approach. TRIZ offers a more systematic although still universal approach to problem solving. It has advantages over other problem-solving approaches in terms of time efficiency and low-cost quality improvement solution. The pillar of TRIZ is the realization that contradictions can be methodically resolved through the application of innovative solutions. Altshuller defined an inventive problem as one containing a contradiction. He defined contradiction as a situation where an attempt to improve one feature of the system detracts from another feature.

1.12.1 TRIZ Methodology

Traditional processes for increasing creativity have a major flaw in that their usefulness decreases as the complexity of the problem increases. At times, the trial-and-error method is used in every process, and the number of trials increases with the complexity of the inventive problem. In 1946, Altshuller was determined to improve the inventive process by developing the “science” of creativity, which led to the creation of TRIZ. TRIZ was developed by Altshuller as a result of analysis of many thousands of patents. He reviewed over 200,000 patents looking for problems and how they were solved. He selected 40,000 as representative of inventive solutions, and the rest were classified as direct improvements easily recognized within the system. Altshuller recognized a pattern where some fundamental problems were solved with solutions that were repeatedly used from one patent to another, although the patent subject, applications, and timings varied significantly. He categorized these patterns into five levels of inventiveness. Table 1.15 summarizes Altshuller’s findings.

TABLE 1.15

Level of Inventiveness

Level	Degree of Inventiveness	Percentage of Solutions	Source of Solution
1	Obvious solution	32%	Personal skill
2	Minor improvement	45%	Knowledge within existing systems
3	Major improvement	18%	Knowledge within the industry
4	New concept	4%	Knowledge outside industry and are found in science, not in technology
5	Discovery	1%	Outside the confines of scientific knowledge

Altshuller noted that, with each succeeding level, the source of the solution required broader knowledge and more solutions to consider before an ideal solution could be found.

TRIZ is a creative thinking process that provides a highly structured approach to generating innovative ideas and solutions for problem solving. It provides tools and methods for use in problem formulation, system analysis, failure analysis, and pattern of system evolution. TRIZ works in contrast to techniques such as brainstorming and aims to create an algorithmic approach to the invention of new systems and refinement of old systems. Using TRIZ require some training and good deal of practice.

The TRIZ body of knowledge contains 40 creative principles drawn from the analysis of how complex problems have been solved, such as

- The laws of systems solution
- The algorithm of inventive problem solving
- Substance-field analysis
- 76 standard solutions

1.12.2 Application of TRIZ

Engineers can apply TRIZ for solving the following problems in construction projects:

- Nonavailability of specified material
- Regulatory changes for using certain types of material
- Failure of dewatering system
- Casting of lower grade of concrete to that of specified higher grade
- Collapse of trench during excavation
- Collapse of formwork

- Collapse of roof slab while casting is in progress
- Chiller failure during peak hours in the summer
- Modifying method statement
- Quality auditor can use to develop corrective actions to audit findings

1.12.3 TRIZ Process

Altshuller has recommended four steps to invent new solutions to a problem. These are

Step 1—Identify the problem

Step 2—Formulate the problem

Step 3—Search for precisely well-solved problem

Step 4—Generate multiple ideas and adopt a solution

The foregoing referred methods are primarily used for low-level problems. To solve more difficult problems, more precise tools are used. These are as follows:

- ARIZ (Algorithm for Inventive Problem Solving)
- Separation Principles
- Substance-Field Analysis
- Anticipator Failure Determination
- Direct Product Evaluation

The quality function deployment (QFD) matrix is also used to identify new functions and performance levels to achieve a truly exciting level of quality by eliminating technical bottlenecks at the conceptual stage. QFD may be used to feed data into TRIZ, especially using the “rooftop” to help develop contradictions.

The different schools for TRIZ and individual practitioners have continued to improve and add to the methodology.

1.13 Quality in Use of CAD Software

With the advent of the computer age, information automation has become a reality. Computers are now being used in design, presentation of documents, estimation, presentation, analysis, planning, and many other applications.

Engineering design is the partial realization of the designer’s concept. Engineering drawing is an abstract universal language used to represent the designer’s concept to others. The conventional method of representing an

engineering drawing is drafting on paper with pen or pencil. Manual drafting is tedious and requires a tremendous amount of patience and time. The invention of computer-aided design (CAD) has had a tremendous effect on the design process, and the computer-aided drafting system has improved drafting efficiency. CAD is a process by which a computer-based program assists in the creation or modification of design. It allows not only passing information more quickly and accurately but also opens the door to integration and automation. A product of the computer era, CAD originated from early computer graphics systems and their development into interactive computer graphics. The 1970s marked the beginning of a new era in CAD—the invention of three-dimensional solid modeling. Since the invention of computer-aided drafting, there has been tremendous progress in CAD, and it is being regularly used in design drafting. In construction projects, CAD is used by all trades such as architectural, structural, mechanical, electrical, infrastructure and landscape engineers, and others. Design software has helped engineers to produce and modify drawings in the related field of applications and has made it possible to integrate and visualize their overall effect and put them to use to construct the facility. Its application has helped in producing fully coordinated design drawings and avoiding any conflict during construction.

A CAD system consists of three major parts:

1. Hardware: Computer and input/output (I/O) devices
2. Operating system: Software
3. Application software: CAD package

Hardware is used to support the software function. Operating system software is the interface between the CAD application software and the hardware. It is important not only for CAD software but for non-CAD software as well. Application software is the heart of the CAD system. CAD consists of programs that do drafting, engineering analysis, 2-D and 3-D drawings, 3-D modeling, and many other engineering-related functions.

AutoCAD is the most commonly used software in the construction project/industry. It is the most commonly used software by the construction project professional. It began as a PC-based drafting package running under the MS-DOS environment and gradually evolved into a full-blown CAD system. Its editions are upgraded to meet the current demands of industries. AutoCAD 2010 is the latest version of AutoCAD.

There are numerous off-the-shelf application packages available; it is beyond the scope of this book to list them all, but they are being used in designing systems in construction projects. The following are the most common application software packages used by all the trades:

- General-purpose by all trades
 - AutoCAD
 - Microsoft Office

- Planning, scheduling, and controlling
 - Primavera
 - Microsoft Project
- Structural design
 - STADD
 - ETABS
- HVAC design
 - HAP
 - APEC
 - HEVACOMP
- Mechanical design
 - ELITE
 - Storm CAD, Water CAD, Sewer CAD
- Electrical design
 - DIALUX
 - ECODIAL
- Landscape
 - Dynascape
- Infrastructure/roads
 - Bentley MX
 - Eagle Point

1.13.1 Building Information Modeling

Building Information Modeling (BIM) is an innovative process of generating a digital database for collaboration and managing building data during its life cycle and for preserving the information for reuse and additional industry-specific applications. It is Autodesk's strategy for the application of information technology to the building industry. It helps in better visualization and clash detection, and is an excellent tool to develop project staging plans, study phasing and coordination issues during the construction project life cycle, preparation of As-Builts, and also during maintenance of the project.

Quality in use aims at defining the quality attributes that are important to the end user. In 1991, the International Organization for Standardization (ISO) introduced ISO/IEC 9126 (1991): Software evaluation quality characteristics and guidelines for their use. ISO/IEC 9126 is a four-part model:

- Part 1: Quality model
- Part 2: External metrics
- Part 3: Internal metrics
- Part 4: Quality in use metrics

There are six characteristics for both external and internal metrics: functionality, reliability, usability, efficiency, maintainability, and portability. They can be further subdivided into sub-characteristics. The quality in use metrics has four characteristics: effectiveness, satisfaction, productivity, and safety.

ISO/IEC 9126 was superseded in 2005 by ISO/IEC 25000: Software Engineering. All the requirements of ISO/IEC 9126 have been taken care of in this standard.

Table 1.16 lists software quality factors to be considered while selecting a software package.

1.14 Value Methodology

1.14.1 Value

Value is difficult to define because it is used in a variety of ways. There are seven classes of value that are recognized today. These are

1. Economic
2. Moral
3. Aesthetic
4. Social
5. Political
6. Religious
7. Judicial

Of all these classes, only economic value can be measured in terms of (hopefully) objective monetary units such as dollars, euros, yen, or dinar. However, economic value is also established through an item's use value (facilities that provide a unit of use work or service) and esteem value (properties that make

TABLE 1.16

Software Quality Factors

Serial No.	Factor	Description
1	Suitability	Whether the application software is suitable and satisfies the intended use and has all the required parameters
2	Compatibility with the operating system	Application software usually operating-system dependent; therefore, attention needed on their compatibility
3	Hardware capability	Whether the RAM and storage memory is sufficient to store the created /modified design data
4	Reliability	Whether the application software will perform its intended use with required precision
5	Acceptability	Whether the designs produced with application software are accepted by the client
6	Credibility	How credible the product is
7	Usability	How easy it is to learn, operate, and transfer input information by translation or interpreting the same to the specific data format
8	Integrability	Whether the program can be integrated with other application software, and how much effort is required for interoperating with other systems
9	Flexibility	Efforts required to modify an operational system
10	Efficiency	Whether the program can perform the amount of computing resources and code required by a program
11	Maintainability	How much effort required for troubleshooting and for fixing an error
12	Testability	How much effort required to test and ensure that the program is performing its intended function
13	Portability	Effort required to transfer the program from one hardware to another and to configure it to the new environment
14	Reusability	Whether the program can be used in other applications related to the packaging and scope of the functions that the program performs
15	Safety	How safe is the program to use

something desirable). We can say that use values cause a product to perform, and esteem values cause it to sell. Use value and esteem value defy precise quantification in monetary terms, so we often resort to multiattribute techniques for evaluating the total value of complex designs and complicated systems or machinery. Accordingly, value can be defined as

$$\text{Value} = \frac{\text{Quality}}{\text{Cost}} \text{ or Value is quality divided by cost.}$$

It means that, if you can provide better facility to the client with lower price, the value goes up.

1.14.2 Value Engineering

Value Engineering (VE) is a technique for evaluating the design of a product/project to assure that essential functions are provided at minimal overall cost to the manufacturer or client/end user. It is a systematic approach to identifying the project's functional objectives with the goal of optimizing design, construction, and future operations. VE is a creative approach to optimizing value. The authors of *Quality in Constructed Projects* by ASCE (p. 239) have described that

In its broadest sense, project value is determined by the relationship of the worth of the project and its elements to their cost. The following expression summarizes the relationship:

$$\text{Value} \sim \frac{(\text{Function} + \text{Performance} + \text{Quality})}{(\text{Cost})}$$

The goal of the VE process is to identify alternatives that maximize this value relationship. The owner's requirements are the basis for establishing values for the items in the numerator. For example, an owner who intends to sell a facility within five years of its completion may place less value in long-term maintenance characteristics than an owner who intends to keep a facility for decades. Owner requirements directly affect the relative value of aesthetics, reliability, sustainable development, maintainability, operability, construction duration, and other characteristics. Improving the quality of elements related to these characteristics usually increase cost. The goal of VE is to achieve a ratio of quality to cost that is acceptable to and in the best interest of the owner.

1.14.2.1 Objective of Value Engineering

The objective of VE is to provide the required product/project functions at a minimum cost and to achieve equivalent or better performance while maintaining all functional requirements defined by the customer/client. VE necessitates a detailed examination of a product/project function and the cost of each item in addition to a thorough review of product/project specifications. It does this by identifying and eliminating unnecessary cost.

1.14.2.2 Value Engineering Team

VE studies are conducted by a multidisciplinary team that focuses on a clearly defined scope. The VE team consists of specialists from a variety of disciplines (design, manufacturing, marketing, etc., for product evaluation; and owner, design professional, contractor, consultant, and construction management/project management, etc., for construction project) focusing on

determining the most effective way to provide high value at an accepted cost to the customer/client end user. While each member of the project team is free to recommend that a VE study be undertaken, it is typically the owner's responsibility to authorize and formally initiate the VE effort.

The success of a VE effort is linked to the experience of the team members. The number and qualifications of VE team members depend on project objectives and the stage of the project life cycle at which VE studies are conducted. VE studies typically involve multiple disciplines. VE team members must be from diverse disciplines and backgrounds and have a range of expertise related to the project's key issues. Each of the team members must have

- Positive attitude and approach
- Technical knowledge related to the product/project
- Higher education
- Professional experience
- Certification from a recognized body as an expert in VE

The VE team is led by a certified value specialist (CVS). SAVE International (The Value Society) manages certification program for CVS.

1.14.2.3 Approach

The VE approach involves brainstorming such questions as

- Does the item have any design features that are not necessary?
- Can two or more parts be combined together?
- How can we cut down the weight?
- Are these nonstandard parts that can be eliminated?

The key to successful VE is to ask critical questions and seek creative answers. The following are sample questions that should be included in a VE study:

- Are all the functions provided required by the customer?
- Can less expensive material be used?
- Can the number of different materials used be reduced?
- Can the design be simplified to reduce the type of items?
- Can a product designed for another project be used?
- Are all surfaces and finishes necessary?
- Would product redesign eliminate a quality problem?
- What is the level of technology required to achieve the owner's objectives?

It is important to question everything and not take anything for granted. Creative solutions can be obtained using classical brainstorming or the nominal group technique.

1.14.2.3.1 Classical Brainstorming

Classical brainstorming is the most well-known and often-used technique for idea generation in a short period of time. It is used when creative and original ideas are desired, and is based on the fundamental principles of deferment of judgment and that quantity breeds quality. The following are the rules for successful brainstorming:

1. Criticism is ruled out—no criticism.
2. Freewheeling is welcomed.
3. Quantity is wanted—more ideas is better.
4. Contribution and improvement are sought—participants should speak whatever ideas pop into their minds.
5. Avoid evaluation—no comments on the idea.

A classical brainstorming session has the following basic steps:

1. *Preparation*: During this period, the participants are selected and a preliminary statement of the problem is circulated among them.
2. *Brainstorming*: A warm-up session with simple unrelated problems is conducted, the relevant problem and the rules of brainstorming are presented, and ideas are generated and recorded using agreed-upon checklists/formats and other techniques if necessary.
3. *Evaluation*: The ideas are evaluated relative to the problem.

Generally, a brainstorming group consists of four to seven people, although some suggest a larger group.

1.14.2.3.2 Nominal Group Technique

The Nominal Group Technique (NGT) involves a structural group meeting designed to incorporate individual ideas and judgments into a group consensus. By correctly applying the NGT, it is possible for groups of people (preferably 5 to 10) to generate alternatives or other ideas for improving the competitiveness of the product/project.

The NGT, when properly applied, draws on the creativity of the individual participants while reducing undesirable effects of most group meetings such as

- The dominance of one or more participants
- The suppression of conflict ideas

The basic format of an NGT session is as follows:

1. Individual silent generation of ideas
2. Individual round-robin feedback and recording the ideas
3. Group's clarification of each idea
4. Individual voting and ranking to prioritize ideas
5. Discussion of group consensus results

The NGT session begins with an explanation of the procedure and a statement of questions, preferably written by the facilitator. The group members are then asked to prepare individual listing of alternatives that they feel are crucial to the survival and health of the organization.

After this phase has been completed, the facilitator calls on each participant, in round-robin fashion, to present one idea from his or her list. Each idea (or opportunity) is then identified in turn and recorded on a flipchart or board by the NGT facilitator, leaving sufficient time between ideas for comments or classification. This process continues until all the opportunities have been recorded, clarified, and displayed for all the members to see. At this point, a voting procedure is used to prioritize the ideas or opportunities. Finally, voting results lead to the development of group consensus on the topic being addressed.

1.14.2.4 Timings of Value Engineering

VE studies benefit project quality at most stages of the project phases. Conducted in the early stages of a project, they tend to provide the greatest benefit, as there is more potential for cost saving. Figure 1.32 illustrates the effectiveness of VE. In fact, in recent years, VE has become an aid to owners in the formulation of goals and objectives before most design work begins.

VE studies for construction projects are conducted at one or more of the following project stages:

- Conclusion of concept design or facilities planning
- 30% design completion (preliminary design)
- 60% design completion
- 90% or 100% design completion (detail design)

VE enhances project quality at every stage of the project phase. In construction projects, VE starts during the conceptual phase.

Concept design: VE performed during the conceptual design phase improves the quality of project design. During this phase, VE involves the investigation of alternatives, design concepts with the client/end user, design professional, project or construction manager, and any other project team member involved in this phase. The project team works to identify the client/end user's requirements and to design concepts with the potential to achieve the owner's objectives.

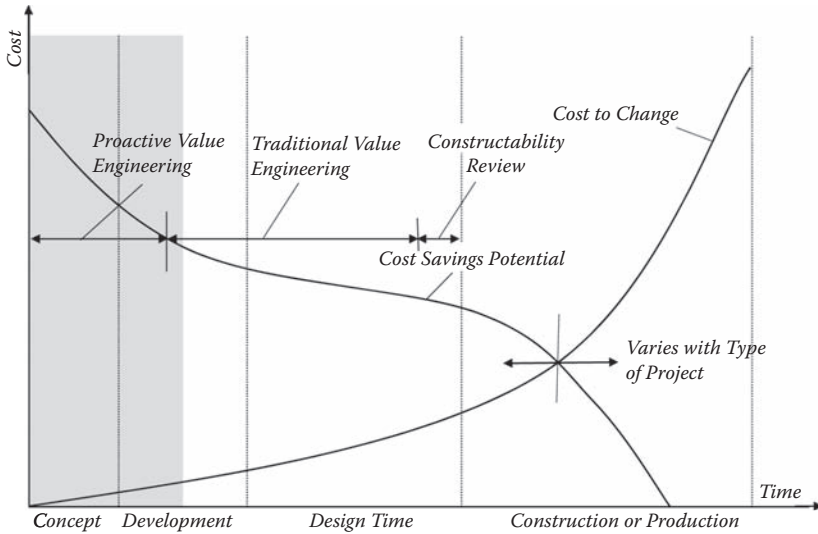

FIGURE 1.32 Effectiveness of Value Engineering. (From American Society of Civil Engineers, *Quality in the Constructed Project*, 2000. Reprinted with permission from ASCE.)

Preliminary design: Major changes resulting from VE studies conducted during this phase can be implemented without significant impacts to the project schedule or budget. The potential for VE-related cost savings is quite substantial during this phase. VE studies conducted during this phase conform to the owner’s/end user’s goals and objectives.

Detailed engineering: VE studies conducted during this phase (60% completion or more) focus on detail design and construction methods and the constructability of the project. Table 1.17 illustrates areas of VE study by design stage.

Construction: VE recommendations made during the construction phase are called Value Engineering Change Proposals (VECPs). These usually relate to alternatives/substitutes of material, equipment, and construction methods normally proposed by the contractor. Savings made due to VE application during this phase are adjusted per agreed-upon terms of contract.

Figure 1.33 illustrates a schematic for review of a project on target cost basis. Target cost is the amount the owner would like to spend to build the facility. In construction projects, the target-based approach can be applied for the development of the facility from the investment point of view, having a fixed budget allocation. The design is reviewed keeping in mind the budget price of the facility to ensure that the facility shall be functionally qualitative and constructed within the targeted budget. If the total estimated cost is greater than the target cost, then the design must be fed back into the VE process.

TABLE 1.17
Area of VE Study by Design Stage

Area of Study	Conceptual	Schematic (Preliminary)	Design Development (Detailed Design)
General project	Design concepts	Schematic floor plans	Floor plans
Budget	Program interpretation	Schematic sections	Sections
Layout	Site/facility massing	Approach to systems integration	Typical details
Criteria & standards	Access, circulation	Floor-to-floor height	Integrated systems
	Design intentions	Functional space	Space circulation
	Net-to-gross ratios		Specifications
Structural	Performance requirements	Schematic basement plan	Basement floor plan
Foundation	Structural bay sizing	Selection of foundation systems	Key foundation elements details
Substructure	Framing systems exploration	Structural system selection	Floor & roof framing plans
Superstructure	Subsurface conditions	Framing plan outline	Sizing of major elements
	Underground concepts	Sizing of elements	Outline specifications
	Initial framing review		
	Structural load criteria		
Architectural	Approach to elevation views to/	Concept elaboration	Elevations
Exterior closure	from building	Selection of wall systems	Key elevation details
Roofing	Roof types & pitch	Schematic elevations	Key roofing details
Interior construction	Interior design	Selection of partitions	Initial finish schedule
	Configuration of key rooms	Circulation sizing	Interior construction elements
Equipment	Organization of circulation schemes	Basic elevator & vertical transportation concepts	Integration of structural framing
	Need & type of vertical circulation	Impact of key equipments on room design	Key interior elevations
	Impact of key equipment on facility & site		Equipment items
	Passive solar usage		

(Continued)

Mechanical HVAC Plumbing Fire protection	Basic energy concepts Impact of mechanical concepts on facility Initial systems selection Source allocation Performance requirements for plumbing, HVAC, fire protection Basic power supply Approach to use of natural & artificial lighting Performance requirements for lighting Need for special electrical systems	Mechanical systems selection Refinement of services & distribution concepts Input to schematic plans Energy conservation	Detailed system selection Initial system drawings & key details Distribution & riser diagrams Outline specification for system design
Electrical Service & distribution Lighting & power	Approach to use of natural & artificial lighting Performance requirements for lighting Need for special electrical systems	Windows/skylight design & sizing Selection of lighting & electrical systems General service, power & distribution concepts Distribution concepts	Detailed systems selection Distribution diagrams Key space Lighting layouts Outline specification for electrical elements
Site Preparation Utilities Landscaping	Site selection Site development criteria Site forms & massing Requirements for access Views to/from facility Utility supply Site drawings	Design concept elaboration Initial site plan Schematic planting, grading, paving plans	Site plan Planting plan Typical site details Outline specifications for site materials

Source: Dell'Isola, A. (1997). *Value Engineering: Practical Applications*. Copyright RSMMeans. With permission.

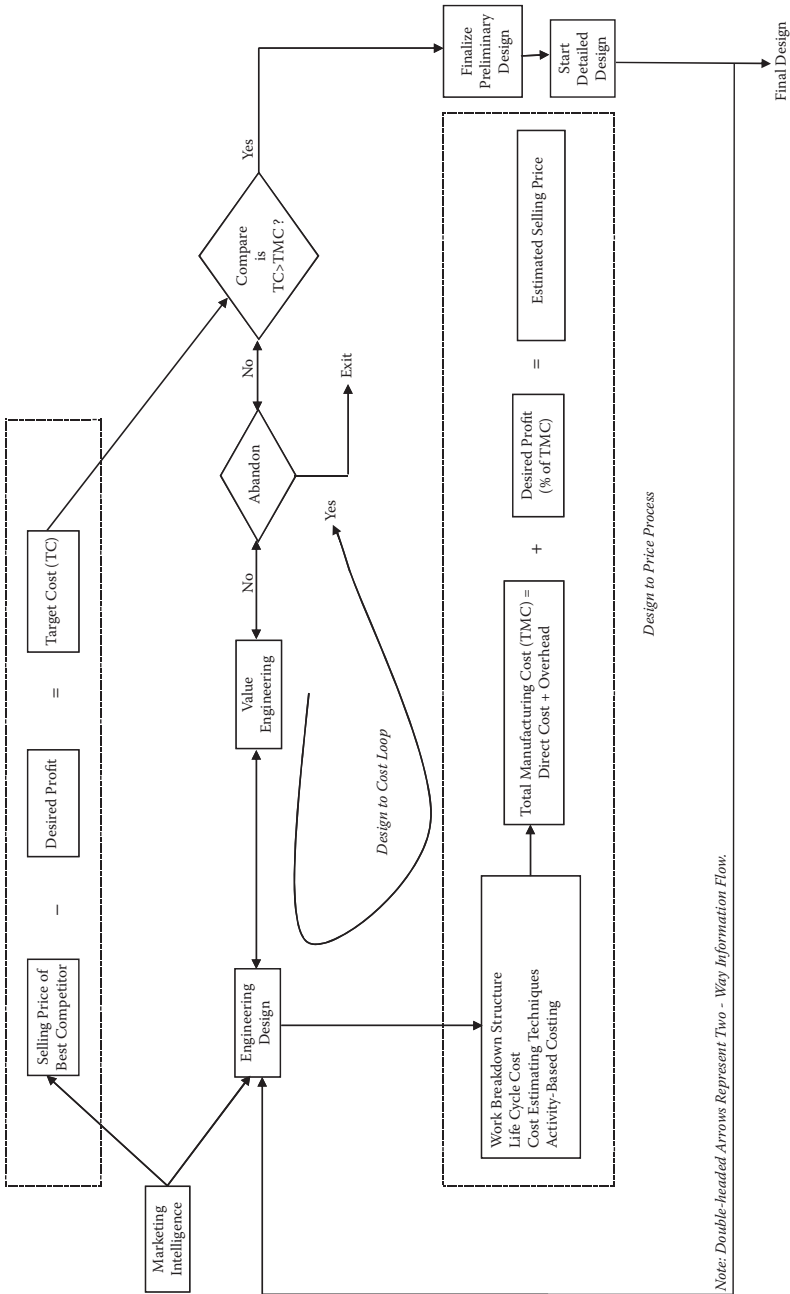

FIGURE 1.33 Schematic for target costing. (From W.G. Sullivan, E.M. Wicks, and J.T. Luxhoj, *Engineering Economy*, 2003. Reprinted with permission from Pearson Education, Inc.)

1.14.2.5 Stages of Value Engineering Study

Figure 1.34 illustrates the VE process summary.

VE studies typically consist of three sequential stages:

1. Preparation
2. Workshop (execution of the VE job plan)
3. Postworkshop

Preparation: This is considered by many to be the most important step of the VE study. During this phase, the owner’s need is defined, VE team members are selected, they are informed about the project, and the scope of the study is established.

Workshop: The VE team convenes a workshop that normally has a six-phase job plan. These are

1. Gathering information
2. Functional analysis
3. Creating alternatives
4. Evaluation
5. Development
6. Presentation

Postworkshop: After the workshop, the VE team prepares a report to support its findings and the implementation program. Its recommendations are reviewed by the owner and the design team before implementation.

Figure 1.35 illustrates the activities performed during the VE study process.

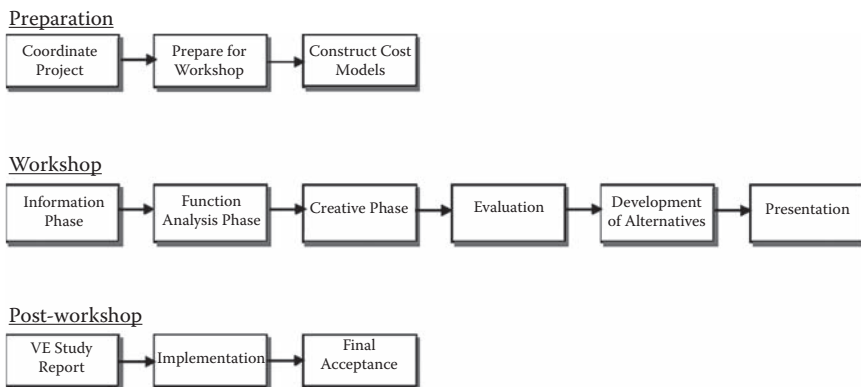

FIGURE 1.34 Value Engineering process summary. (From ASCE, *Quality in Constructed Project*, 2000. Reprinted with permission from ASCE.)

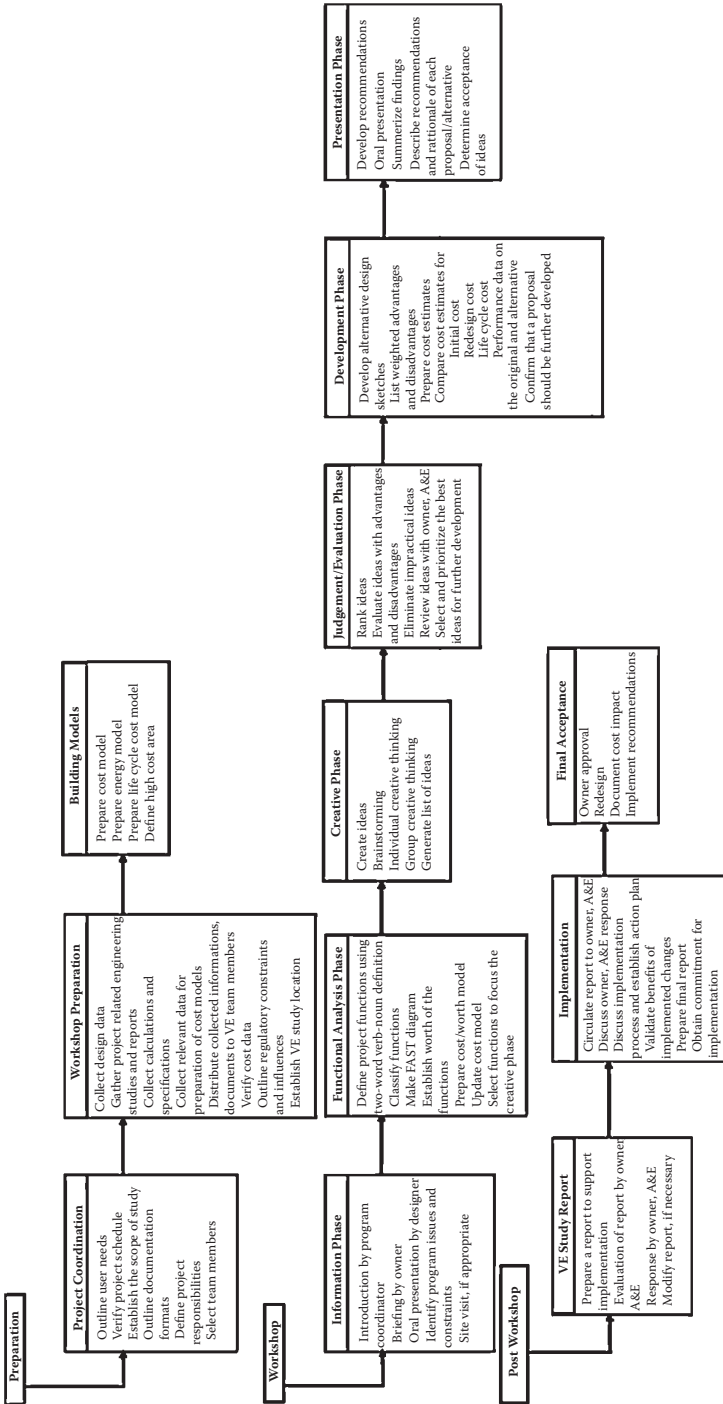

FIGURE 1.35 VE study process activities.

1.14.2.6 Function Analysis System Technique (FAST)

FAST is a technique that specifically illustrates the relationship of all functions within a specific project utilizing a “how–why” logic pattern based on intuitive logic. It is a helpful diagnostic tool, asking questions that generate basic information about project functions. The FAST diagram is especially helpful if the VE team is uncertain of project goals. The following are types of FAST diagrams: classic, customer/user, technical. Figure 1.36 illustrates a typical FAST concept diagram.

1.14.2.7 The Benefits of Value Engineering

The benefits of VE usually come from improvements in the efficiency of the project delivery system, refinements to specific features, or the development of new approaches to achieving the owner’s requirements. The first item most owners look at when they consider VE is potential cost savings. However, VE focuses on improving the relationship of function, performance, and quality to cost—not merely cutting cost.

The benefits of VE in construction are

- Reduce project construction cost
- Improve project schedule
- Simplify procedures
- Increase procurement efficiency
- Use resources more effectively
- Decrease operation and maintenance cost

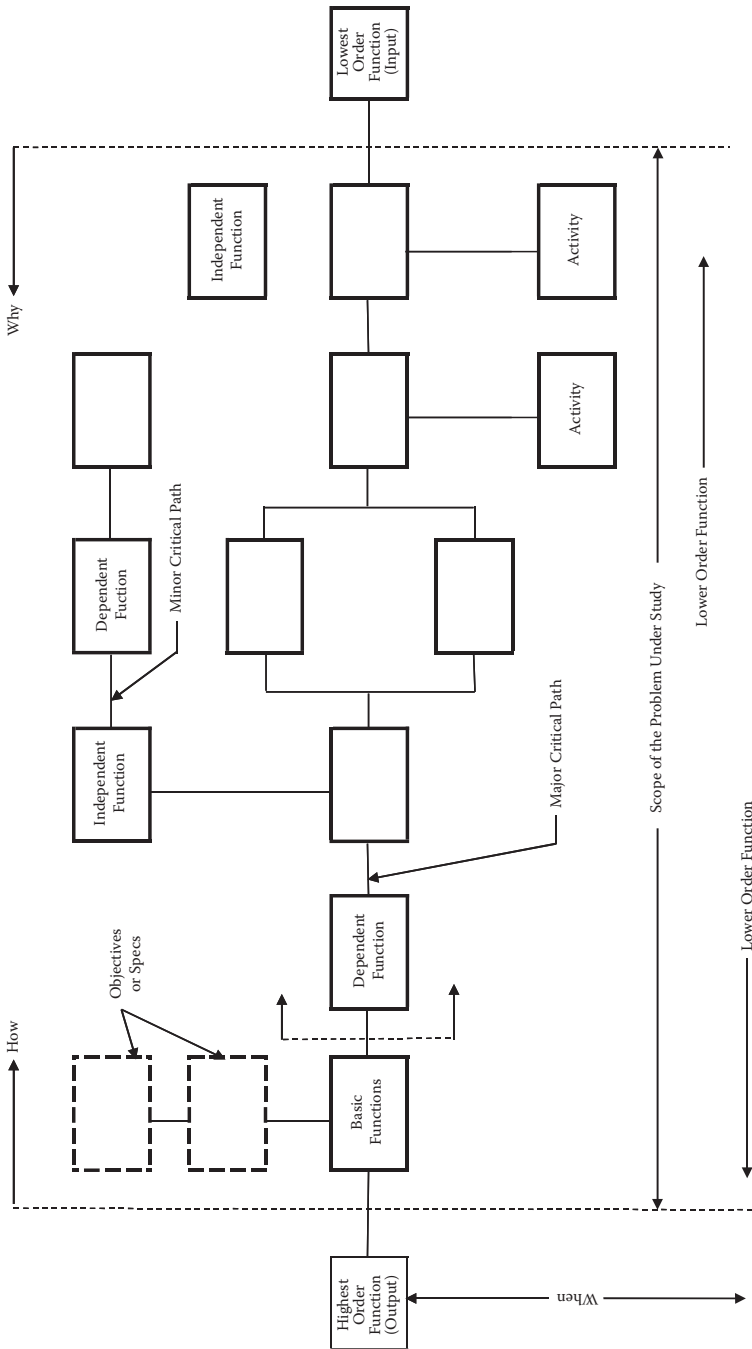

FIGURE 1.36 FAST model. (From SAVE International, 222.value-eng.org. Reprinted with permission from SAVE International.)

2

Integrated Quality Management

2.1 Introduction

A quality system is a framework for quality management. It embraces the organizational structure, procedure, and processes needed to implement quality management. The adequacy of the quality system, and the quality of products, services, and processes are judged by their compliance to specified/relevant standards. Standards have important economic and social repercussions. They are useful to industrial and business organizations of all types, to government, and to other regulatory bodies, to conformity assessment professionals, to suppliers and customers of products and services in both the public and private sectors, and to people in general in their role as customers and users. Standards provide governments with a technical base for health, safety, and environmental legislation.

2.2 Quality Standards

A standard is simply a definition of how something should be.

Per Pyzdek (1999):

Standards are documents used to define acceptable conditions or behaviors and to provide a base line for assuring that conditions or behaviors meet the acceptable criteria. In most cases standards define minimum criteria; world class quality is, by definition, beyond the standard level of performance. Standards can be written or unwritten, voluntary or mandatory. Unwritten quality standards are generally not acceptable. (p. 2)

Pyzdek (1999) further states that quality standards serve the following purpose:

Standards educate—They set forth ideals or goals for the guidance of manufacturers and users alike. They are invaluable to the

manufacturer who wishes to enter a new field and to the naïve purchaser who wants to buy a new product.

Standards simplify—They reduce the number of sizes, the variety of process, the amount of stock, and the paperwork that largely accounts for the overhead costs of making and selling.

Standards conserve—By making possible large-scale production of standard designs, they encourage better tooling, more careful design, and more precise controls, and thereby reduce the production of defective and surplus pieces. Standards also benefit the user through lower costs.

Standards provide a base upon which to certify—They serve as hallmarks of quality which are of inestimable value to the advertiser who points to proven values, and to the buyer who sees the accredited trademark, nameplate, or label. (p. 3)

Standards are used to ensure that a product, system, or service measures up to its specifications and is safe for use. Standards are the key to any conformity assessment activity.

The International Organization for Standardization (ISO) has given the importance of standards as follows:

Standards make an enormous contribution to most aspects of our lives. Standards ensure desirable characteristics of products and services such as quality, environmental fitness, safety, reliability, efficiency, and interchangeability and at an economical cost.

When products and services meet our expectations, we tend to take this for granted. And be unaware of the role of standards. However, when standards are absent, we soon notice. We soon care when products turn out to be poor quality, do not fit, are incompatible with equipment that we already have, are unreliable or dangerous. When products, systems, machinery and devices work well and safely, it is often because they meet standards.

Standard setting is one of the first issues in developing a quality assurance system, and increasingly organizations are relying on readily available standards rather than developing their own. Each standard should be

- Clearly written in simple language that is unambiguous
- Convenient in understanding
- Specific in setting out precisely what is expected
- Measurable so that the organization can know whether it is being met
- Achievable, that is, the organization must have the resources available to meet the standard
- Constructible

Chung (1999) defines standards as a reference base that is required to judge the adequacy of a quality system. He further states that a “quality system has to cover all the activities leading to the finished product. Depending on the scope of operation of the organization, these activities include planning, design, development, purchasing, production, inspection, storage, delivery, and after-sales service” (p. 14).

2.3 Standards Organizations

There are many organizations that produce standards; some of the best-known organizations in the quality field are

1. International Organization for Standardization (ISO)
2. International Electrotechnical Commission (IEC)
3. American Society for Quality (ASQ)
4. American National Standards Institute (ANSI)
5. American Society for Testing and Materials (ASTM)
6. Institute of Electrical and Electronic Engineers (IEEE)
7. European Committee for Standardization (CEN)
8. European Committee for Electrotechnical Standardization (CENELEC)
9. American Society for Heating, Refrigerating, and Air-Conditioning Engineers (ASHRAE)
10. National Fire Protection Association (NFPA)
11. British Standards Institution (BSI)

Standards produced by these organizations/institutes are recognized worldwide. These standards are referred in the contract documents by the designers to specify products or systems or services to be used in a project. They are also used to specify the installation method to be followed or the fabrication works to be performed during the construction process. Table 2.1 lists some of the most common standards referred to in the particular specifications of building construction projects.

Apart from these there have been many other national and international quality system standards. These various standards have commonalities and historical linkage. However, in order to facilitate international trade, delegates from 25 countries met in London in 1946 to create a new international organization. The objective of this organization was to facilitate international coordination and unification of industrial standards. The new organization, International Organization for Standardization, ISO, officially began operation on February 23, 1947.

TABLE 2.1

Most Common Standards Used in Building Construction Projects

Serial No.	Related Division	Section	Related Standards
1	Concrete	Reinforcement	BS 4449, ASTM A615/A615M
		Cement	ASTM C150, ASTM C295, ASTM C33
		Concrete	ASTM C94, ACI 301, ACI 117
2	Masonry	Concrete masonry units	ASTM C140, ASTM C1314, ASTM C270, ASTM C1019
3	Metals	Material fabrication	ASTM A6/A6M, ASTM A36, ASTM 490, AISC 89
4	Wood and plastic	Material, treatment, paneling	BSEN 942, BSEN 636, BS 1203, BS 1088, BS 4079, BS 1282, BSEN 301, BSEN 302, ASTM E84, AWI Quality Standards
5	Thermal and moisture protection	Liquid waterproofing, bituminous waterproofing, membrane waterproofing	ASTM C836, D412, D570, D903, ASTM D1187, ASTM D312, ASTM D1227, ASTM D4479
		Building insulation	ASTM C558, ASTM C578, ASTM C612, ASTM 665
6	Doors and windows	Steel doors	SDI 105, SDI 108, SDI 111
		Aluminum doors	AAMA 101, AAMA 603
		Wooden doors	NWWDA-ISI –A
		Curtain wall	AAMA 101, ASTM E283
		Glazing	AAMATIR A7, ANSIZ 971
7	Finishes	Gypsum plaster	ASTM C11, ASTM E119, ASTM E90, ASTM E413
		Cement plaster	ASTM C150, ASTM C260, ASTM C897, ASTM C926, ASTM C932, ASTM C1063, ASTM E488, ASTM A641M, ASTM A653M, ASTM C847
		Tiling	ANSI A137.1
		Acoustic ceiling	ASTM E1264, ASTM E795, ASTM E1264, ASTM C635, ASTM E488, ASTM B633, ASTM A641
		Metallic ceiling	ASTM B209, ASTM 591, ASTM E1264, ASTM E795, ASTM C635, ASTM C636, ASTM A641, ASTM A653
8	Specialties	Partitions Landscape	
9	Conveying systems	Elevators, escalators	EN 81, 95/96/EC, 89/336/EEC, 89/106/EEC, ANSI/ASME/A17.1, BS 5655/BSCP 407
10	Fire suppression	Firefighting system	NFPA 10, NFPA 13, NFPA 14, B 5274
		Firefighting pumps	NFPA 20

TABLE 2.1 (Continued)

Most Common Standards Used in Building Construction Projects

Serial No.	Related Division	Section	Related Standards
11	Plumbing	Plumbing piping	ISO 2531, BS 4660, BS 4514, ASTM B88, ASTM B 306, ASTM A6.A8, ASTM 16.22, API 600, ASTM A-74, ASTM A-53, ASTM A-106, ANSI B 16.3, ASTM D1785, ASTM D2729, ASTM D2665, ISO R161
		Hydronic piping	ASTM B 16.9, ASTM 16.3
		Hydronic pumps	DIN 24255, EN 733, ISO 2858, ISO 5199, BS 3829, BS 5257, BS 3456, ANSI 316
		Plumbing equipment	ASTM B16.9, ASTM B16.3, BS 3829, BS 5257, BS 3456, ANI 316
12	HVAC	Water distribution pumps	UL 778
		Chillers	ASHRAE 15, ARI, UL 465
		Chiller piping	ANSI/ASME B-31.1
		Chilled water pumps	DIN 24255, EN 733, ISO 2858, ISO 5199, BS 3829, BS 5257, BS 3456, ANSI 316
		Cooling towers	CTI 201
		Air handling unit	EN 1216, ARI
		Fan coil units	ARI 410, ARI 440
13	Automation	Fans and ventilators	UL 705
		Building automation systems	
14	Electrical	Conduit, trunking, cable tray, raceways	BS 4568,BS 4607, BS 6099, BS 4678, BS 1449, BS 1494, BS 729 (for galv.), BS 21767, BS 31, BS 731
		Wiring accessories	BS 3676, BS 1363, BS 4343, BS 5420, BS 4662, BS 5733, BS 5419, BS 546, BS 7001, IEC 309
		Wires and cables	BS 6387,BS 6724,BS 6207, BS 7629, BS 4533, BS 6007, BS 6500, IEC 502, IEC 331, BS 6234, BS 6346, IEC 227, IEC 540
		Bus duct	IEC 439
		Structured cabling	ANSI EIA/TIA-568, ANSI EIA/TIA-569, ANSI EIA/TIA 606, ANSI EIA/TIA 607,IEC 11801, EN 50173, IEEE 802.3ab, IEEE 802.3z
		Lighting fixtures	IEC 598.BS 4533, BS 5042, BS 1853, BS 4782
		Grounding, lightning protection	BS 6651, EN 62305, BS 7430

(Continued)

TABLE 2.1 (Continued)

Most Common Standards Used in Building Construction Projects

Serial No.	Related Division	Section	Related Standards
		Main low tension panels, switch boards, distribution boards, motor control centers	IEC 185, IEC 186, IEC 269, IEC 292, IEC 439, IEC 529, IEC 947, BS 5486, IEC 5750, BS 5420, BS 159, BS 37, IEC 1008
		Motor starters	IEC 292
		Disconnect switches	BS 5419, AC 23, BS88, IEC 408
		Emergency power supply	ISO 8528, NFPA 37, NFPA 99, NFPA 101, NFPA 110, BS 5514, BS 4999, BS 649, BS 5000
		Automatic transfer switch	IEC 947, UL 508, UL 1008, NFPA 70, NFPA 99, NFPA 110, IEEE 446, NEMA Standard ICS 10
		Fire alarm system	NFPA 70, NFPA 71, NFPA 72, BS 5839
15	Communication	Communication system	ISO/IEC 11801, EN 50173, EIA/TIA 568, EIA/TIA 569

2.4 International Organization for Standardization (ISO)

ISO is a network of national standards institutes of 157 countries (as of September 2007), formed on the basis of one member per country, with a Central Secretariat in Geneva, Switzerland, that coordinates the system.

ISO is the world's largest developer and publisher of international standards. It is a nongovernmental organization that forms a bridge between the public and private sectors. ISO has more than 16,500 international standards. Of all the standards produced by ISO, the ones that are most widely known are the ISO 9000 and ISO 14000 series. ISO 9000 has become an international reference for quality requirements in business-to-business dealings, and ISO 14000 looks to achieve at least as much, if not more, in helping organizations to meet their environmental changes. ISO 9000 and ISO 14000 families are known as "generic management system standards."

The ISO 9000 family is primarily concerned with "quality management." This means what the organization does to fulfill

- The customer's quality requirements
- Applicable regulatory requirements, while aiming to enhance customer satisfaction
- Achieve continual improvement of its performance in pursuit of the objectives

The ISO 14000 family is primarily concerned with “environmental management.” This means to

- Minimize harmful effect on the environment caused by its activities
- Achieve continual improvement with its environmental performance

ISO standards are updated periodically since they were originally published in 1987. ISO 9000 actually comprises several standards.

The 1994 version of the ISO 9000 series was made up of following standards:

- ISO 9000: Quality management and quality assurance standards.
- ISO 9001: Quality systems—Model for quality assurance in design, development, production, installation, and servicing.
- ISO 9002: Quality systems—Model for quality assurance in production installation and servicing.
- ISO 9003: Quality systems—Model for quality assurance in final inspection and test.
- ISO 9004: Quality management and quality systems element guidelines.

These standards were simplified in December 2000 and are known as ISO 9000:2000. In the revised version, ISO 9002 and ISO 9003 no longer exist, having been incorporated into ISO 9001:2000. ISO 9000:2000 consists of the following standards:

- ISO 9000: Quality fundamentals and vocabulary
- ISO 9001: Quality management systems
- ISO 9004: Quality management system guidelines for performance improvement

The ISO 9000:1994 had 20 elements listed under the ISO 9001 model for quality assurance in design, development, production, installation, and servicing. These elements are summarized, with relevant ISO 9000:2008 references, under Table 2.2 in the context of building construction. This will give an idea about the changes in the revised QMS system.

ISO 9000:2000 specifies requirements for a quality management system for any organization that needs to demonstrate its ability to consistently provide product that meets customer and applicable regulatory requirements and to enhance customer satisfaction.

The tremendous impact of ISO 9001 and ISO 14001 on organizational practices and on trade stimulated the development of other ISO standards and deliverables that adapt the generic management system to specific sectors or aspects. These are

1. Food Safety Management Systems ISO 22000
2. Information Security Management Systems ISO 27001
3. Supply Chain Security Management Systems ISO 28000

TABLE 2.2

Summary of Quality System Requirements

ISO 9001 Clause No.	Quality System Element	Quality Functions Required
4.1 (5.1,5.3,5.5,5.6) ^a	Management responsibility	Define, document and publicize quality policy. Define, document responsibility, authority and interrelation of staff. Identify and provide adequate resources. Appoint quality manager. Review quality system at regular intervals.
4.2 (4.1,4.2.1)	Quality system	Establish, document and maintain quality system. Prepare and effectively implement documented procedures. Define and document how quality planning is conducted for a project or contract, including preparation of a quality plan.
4.3 (5.2,7.2)	Contract review	Review tender before submission. Review contract before signing. Review variation order before acceptance and transfer amended requirements to functions concerned.
4.4 (7.3)	Design control	Plan design activities. Identify and review design input. Review, verify, and validate design output.
4.5 (4.2.3)	Document and data control	Review and approve documents prior to issue. Review and approve document changes prior to issue. Control distribution and updating of documents.
4.6 (7.4.1,7.4.2,7.4.3)	Purchasing	Evaluate and select subcontractors on basis of capabilities for quality. Exercise appropriate control over subcontractors. Review and approve purchasing documents (including subcontracts) prior to release. Specify arrangements for verification and product release of subcontracted product or work at subcontractor's premises if required. Allow the client or his representative to verify subcontracted product or work at the contractor's/subcontractor's premises where specified in contract.
4.7 (7.5.4)	Control of customer supplied product	Control verification, storage, and maintenance of customer-supplied product.

TABLE 2.2 (Continued)

Summary of Quality System Requirements

ISO 9001 Clause No.	Quality System Element	Quality Functions Required
4.8 (7.5.3)	Product identification and traceability	Identify material and semi-finished product (e.g., prefabricated units) from receipt and during all stages of production, delivery, and installation, where appropriate. Provide unique identification of individual product or batches where specifically required.
4.9 (6.3,6.4,7.5.1,7.5.2)	Process control	Identify, plan, and control production, installation and servicing processes, including provision of documented procedures and suitable equipment. Assign qualified operators to carry out special processes.
4.10 (7.4.3,8.2.4,7.5.3)	Inspection and testing	Conduct receiving inspection and testing of incoming materials and components. Conduct in-process inspection and testing of semi-finished work in accordance with quality plan. Maintain signed-off records of inspections and tests.
4.11 (7.6)	Control of inspection, measuring and test equipment	Use inspection, measuring, and testing equipment capable of necessary accuracy and precision. Calibrate the equipment at prescribed intervals, or prior to use, and indicate its calibration status. Review previous results when the equipment is found to be out of calibration.
4.12 (7.5.3)	Inspection and test status	Indicate by suitable means the conformance or nonconformance of product or work with regard to inspect and test performed.
4.13 (8.3)	Control of nonconforming product	Identify and segregate, when practical, any nonconforming product or work. Review and dispose of the nonconforming product or work by an authorized person. Inspect and/or test the product or work again after repair.
4.14 (8.5.2,8.5.3)	Corrective and preventive action	Investigate cause of nonconformities, including client complaints. Take corrective/preventive action to eliminate cause/potential cause of nonconformities. Implement and record changes to documents procedures resulting from corrective/preventive action. Ensure that corrective/preventive action is taken and that it is effective.

(Continued)

TABLE 2.2 (Continued)

Summary of Quality System Requirements

ISO 9001 Clause No.	Quality System Element	Quality Functions Required
4.15 (7.5.5)	Handling, storage, packaging, preservation, and delivery	Establish methods of handling product that prevent damage or deterioration. Use designated storage areas to prevent damage or deterioration. Assess condition of product in stock at appropriate intervals. Protect product during delivery.
4.16 (4.2.4)	Control of quality records	Retain quality records for prescribed period. Maintain quality records in such a way that they are identifiable, retrievable and secured against damage, deterioration, or loss.
4.17 (8.2.2)	Internal quality audits	Plan and schedule internal quality audits. Assign independent personnel to carry out internal quality audits. Conduct follow-up audits if necessary.
4.18 (6.2.2)	Training	Identify training needs of staff. Provide training required.
4.19 (7.5.1)	Servicing	Verify that servicing meets specified requirements.
4.20 (8.1,8.2.3,8.4)	Statistical techniques	Identify the need for statistical techniques in quality control. Implement and control the application of statistical techniques.

Source: Chung, H.W. (1999). *Understanding Quality Assurance in Construction*. Reprinted with permission from Cengage Learning Services Limited.

^a Numbers in parentheses refer to ISO 90001:2000.

ISO 22000:2005, published on September 1, 2005, is related to the safe food supply management system to ensure that food is safe at the time of human consumption. ISO 27001:2005 is related to information security system. ISO 28000:2005 is related to supply management system to help combat threats to safe and smooth flow of international trade.

In keeping with the process of updating the standards, certain clauses of ISO 9001:2000 of the quality management system were amended during 2008 in order to improve the quality management system, and accordingly the amended standard is known as ISO 9001:2008. ISO 9001:2008 includes Annex B, which outlines the text changes that have been made to specific clauses.

2.5 ISO 9000 Quality Management System

ISO 9000 quality system standards are a tested framework for taking a systematic approach to managing the business process so that organizations turn out products or services conforming to customer's satisfaction. The typical ISO quality management system is structured on four levels, usually portrayed as a pyramid. Figure 2.1 illustrates this.

On top of the pyramid is the quality policy, which sets out what management requires its staff to do in order to ensure quality management system. Underneath the policy is the quality manual, which details the work to be done. Beneath the quality manual are work instructions or procedures. The number of manuals containing work instructions or procedures is determined by the size and complexity of the organization. The procedures mainly discuss the following:

- What is to be done?
- How is it done?
- How does one know that it has been done properly (for example, by inspecting, testing, or measuring)?
- What is to be done if there are problems (for example, failure)?

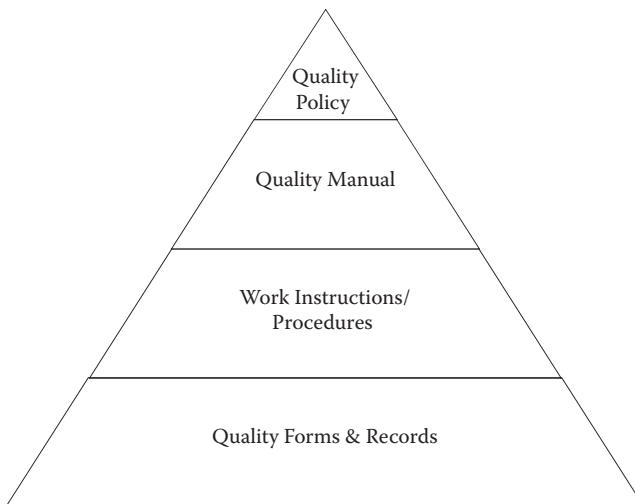

FIGURE 2.1
Quality management system pyramid.

The bottom level of hierarchy contains forms and records that are used to capture the history of routine events and activities.

The ISO 9000 quality management system requires documentation that includes a quality manual and quality procedures, as well as work instructions and quality records. All documentation (including quality records) must be controlled according to a document control procedure. The structure of the quality management system depends largely on the management structure in the organization.

ISO 9001:2000 identifies certain minimum requirements that all quality management systems must meet to ensure customer satisfaction. ISO 9001:2000 specifies requirements for quality management systems when an organization

- Needs to demonstrate its ability to consistently provide product that meets customer and applicable regulatory requirements
- Aims to enhance customer satisfaction through the effective application of the system, including processes for continual improvement of the system and the assurance of conformity to customer and applicable regulatory requirements

2.5.1 Quality System Documentation

A quality system has to cover all the activities leading to the final product or service. The quality system depends entirely on the scope of operation of the organization and particular circumstances such as number of employees, type of organization, and physical size of the premises of the organization. The quality manual is the document that identifies and describes the quality management system. The quality management system is based on the guidelines for performance improvement per ISO 9004:2000 and the quality management requirements. ISO 9000:2000 outlines the necessary steps to implement the quality management system. These are

1. Identify the process (activities and necessary elements) needed for quality management system.
2. Determine the sequence and interaction of these processes and how they fit together to accomplish quality goals.
3. Determine how these processes are effectively operated and controlled.
4. Measure, monitor, and analyze these processes and implement action necessary to correct the process and achieve continual requirements.
5. Ensure that all information is available to support the operation and monitoring of the process.
6. Display the most options, thus helping make the right management system.

ISO 9001:2000 requirements fall into the following sections:

1. Quality management system
2. Management responsibility
3. Resource management
4. Product realization
5. Measurement analysis and improvement

In the construction industry, a contractor may be working at any time on a number of projects of varied natures. These projects have their own contract documents to implement project quality, which require a contractor to submit a contractor's quality control plan to ensure that specific requirements of the project are considered to meet client's requirements. Therefore, while preparing a quality management system at a corporate level, the organization has to take into account tailor-made requirements for the projects and accordingly the manual should be prepared.

Table 2.3 lists an example contents of a quality management system manual for building construction organization (contractor) and Table 2.4 lists example contents of a quality management manual for an engineering consultant (design and supervision).

2.6 ISO Certification

Following are the details of ISO certification, registration, and accreditations, as mentioned on the ISO Web site:

In the context of ISO 9000 or ISO 14000, "certification" refers to the issuing of written assurance (the certificate) by an independent, external body that has audited an organization's management system and verified that it conforms to the requirements specified in the standard.

"Registration" means that the auditing body then records the certification in its client register so the organization's management system has therefore been both certified and registered. Therefore, in the ISO 9000 and ISO 14000 contexts, the difference between the two terms is not significant and both are acceptable for general use.

"Certification" seems to be the term most widely used worldwide, although "registration" is often preferred in North America, and the two are also used interchangeably.

On the contrary, using "accreditation" as an interchangeable alternative for "certification" or "registration" is a mistake, because **it means something different**.

TABLE 2.3

Quality Manual Document–Contractor

Document No.	Document Title	Relevant Clause in ISO 9001:2008	Version/ Revision Date
QC-0	Circulation list		
QC-00	Records of revision		
QC-1	Scope of quality management system	4.1	
QC-2	Project quality management system	4.1	
QC-3.1	Control of documents for general application	4.2.3	
QC-3.2	Control of documents for specific projects	4.2.3	
QC-4	Control of quality records	4.2.4	
QC-5	Customer focus	5.2	
QC-6	Quality policy	5.3	
QC-7	Preparation and control of project quality plan	5.4.2	
QC-8	Management responsibilities (organization chart)	5.5.1	
QC-9	Internal communication	5.5.3	
QC-10	Management review	5.6	
QC-11	Construction resources (equipment and machinery)	6.1	
QC-12	Human resources	6.2.1	
QC-13.1	Training in quality system	6.2.2	
QC-13.2	Training in quality auditing	6.2.2	
QC-13.3	Training in operational/technical skills	6.2.2	
QC-14	Infrastructure	6.3	
QC-15	Work environment	6.4	
QC-16	Tender review	7.2.1/2/3	
QC-17	Contract review	7.2.1/2/3	
QC-18	Variation review	7.2.2	
QC-19	Engineering and design control	7.3.1	
QC-20	Evaluation of subcontractors and selection	7.4.1	
QC-21	Purchasing	7.4.1/2/3	
QC-22.1	Inspection of subcontracted work	7.4.3	
QC-22.2	Incoming material inspection and testing	7.4.3	
QC-23	Installation procedures	7.5.1/2	
QC-24	Product identification and traceability	7.5.3	
QC-25	Identification of inspection and test status	7.5.3	
QC-26	Control of owner supplied items	7.5.4	
QC-27	Handling and storage	7.5.5	
QC-28	Control of construction, measuring and test equipment	7.6	
QC-29	Project review	8.1	
QC-30	Internal quality audits	8.2.2	

TABLE 2.3 (Continued)

Quality Manual Document–Contractor

Document No.	Document Title	Relevant Clause in ISO 9001:2008	Version/ Revision Date
QC-31	Construction inspection, testing, and commissioning	8.2.4	
QC-32.1	Control of nonconforming product	8.3	
QC-32.2	Control of nonconforming work	8.3	
QC-32.3	Control of client complaints	8.3	
QC-33	Corrective action	8.5.2	
QC-34	Preventive action	8.5.3	

In the ISO 9000 or ISO 14000 context, accreditation refers to the formal recognition by a specialized body—an accreditation body—that a certification body is competent to carry out ISO 9000 or ISO 14000 certification in specified business sectors.

In simple terms, accreditation is like certification of the certification body. Certificates issued by accredited certification bodies may be perceived on the market as having increased credibility.

Thus, it should be understood that the certification body is a third-party company registered with an established national accreditation board and is authorized to issue a certificate of conformance after evaluating the conformance of an organization’s management system to the requirements of appropriate standard.

With the advent of globalization and competitive market, it has become essential to implement a quality management system in an organization and to get it certified from a third party to enhance business opportunities in the international market. The ISO 9000 quality management system is accepted worldwide, and international customers prefer to do business with organizations having ISO certification. An ISO quality management system includes all activities and overall management functions that determine quality policy, objectives, and responsibilities and their implementation.

ISO certification is not compulsory; however, it is required for competitive advantage. ISO is valuable to firms because it provides a framework so they can assess where they are, where they would like to be, and what is their standing in the international market. Implementation of an ISO management system in the organization brings in increased effectiveness and efficiency of operations and ensures that the product satisfies customer requirements. ISO 9000 and ISO 14000 concern the way an organization goes about its work and processes. ISO 9000 and ISO 14000 are not product standards.

TABLE 2.4

Lists in Quality Manual Document–Consultant (Design and Supervision)

Document No.	Title of List	Relevant Clause in ISO 9001:2008	Version/ Revision Date
QC-0	Circulation list		
QC-00	Records of revision		
QC-1	Scope of quality management system	4.1	
QC-2	Project quality management system	4.1	
QC-3.1	Control of documents for general application	4.2.3	
QC-3.2	Control of documents for specific projects	4.2.3	
QC-4	Control of quality records	4.2.4	
QC-5	Customer focus	5.2	
QC-6	Quality policy	5.3	
QC-7	Preparation and control of project quality plan	5.4.2	
QC-8	Management responsibilities (organization chart)	5.5.1	
QC-9	Internal communication	5.5.3	
QC-10	Management review	5.6	
QC-11	Office equipment	6.1	
QC-12	Human resources	6.2.1	
QC-13.1	Training in quality system	6.2.2	
QC-13.2	Training in quality auditing	6.2.2	
QC-13.3	Training in operational/technical skills	6.2.2	
QC-14	Infrastructure	6.3	
QC-15	Work environment	6.4	
QC-16	Planning of engineering design and quality plan	7.1/7.3.1/7.3.7	
QC-17	Evaluation of subconsultant and selection	7.4.1	
QC-18	Purchasing	7.4.1/2/3	
QC-19	Engineering design procedure	7.5.1/2	
QC-20.1	Construction supervision procedure	7.5.1/2	
QC-20.2	Project management procedure	7.5.1/2	
QC-20.3	Construction management procedure	7.5.1/2	
QC-21	Project review (management and control)	8.1	
QC-22	Internal quality audits	8.2.2	
QC-23.1	Control of nonconforming work	8.3	
QC-23.2	Control of client complaints	8.3	
QC-24	Corrective action	8.5.2	
QC-25	Preventive action	8.5.3	

There are three types of audits that can be done on ISO quality management systems:

1. First-Party Audit—Audit your own organization (internal audit).
2. Second-Party Audit—Audit of supplier by the customer.
3. Third-Party Audit—Totally independent of the customer–supplier relationship. The best certification of a firm is through third party.

ISO 9000 certification audit is done by a certification body that has been accredited or has been officially approved as competent to carry out certification in a specified business sector by a national accreditation body.

Table 2.5 describes the ISO certification process. Figure 2.2 diagrammatically summarizes the ISO certification process, and Figure 2.3 illustrates an example QMS Certification Schedule that is developed taking into consideration overall certification requirements. The duration of each activity and the overall period to obtain certification may vary from company to company depending on the size and nature of the business.

With the certification of ISO 9000:2000, organizations obtain the following advantages:

- Increased market share
- Increase in revenues
- Continuous improvement in organizational process
- Consistency in products/services quality
- Improvement in staff performance
- Effectiveness in the utilization of staff
- Efficient utilization of time, money, and other resources
- Customer satisfaction and confidence in the organization's products/services

TABLE 2.5

ISO 9000 Certification Process

-
1. *ISO 9000 Assessment.* The initial assessment is a detailed review of the company's quality systems and procedures compared to ISO 9000 requirements. This process defines the scope of the ISO 9000 project.
 2. *Training.* All employees must be trained in two areas. First, they must have an overall understanding of ISO 9000 vocabulary requirements, the role of the quality manual, and the benefits that will be derived from the system. Second, they must understand the actual day-to-day process of upgrading and improving procedures.
 3. *Documentation of Work Instructions.* All procedures must be described and documented so that they can be understood prior to approval. Once completed, this documentation should outline every process a company undertakes that affects the quality of its finished products.
 4. *Quality Assurance Manual.* While ISO 9000 standards do not require a quality assurance and policy manual, they do require that a company document everything it does and every system that affects the quality of the finished product. The manuals are often used to assemble all documentation in one place.
 5. *Registration Audit.* The final step in certification is an audit by an organization chosen as the external registrar to see that system is working as described in the quality manual and that it meets ISO 9000 requirements.
-

Source: Stevenson, T.H. and Barnes, F.C. *IEEE Engineering Management Review*, 29, 4, © 2001. Reprinted with permission from IEEE.

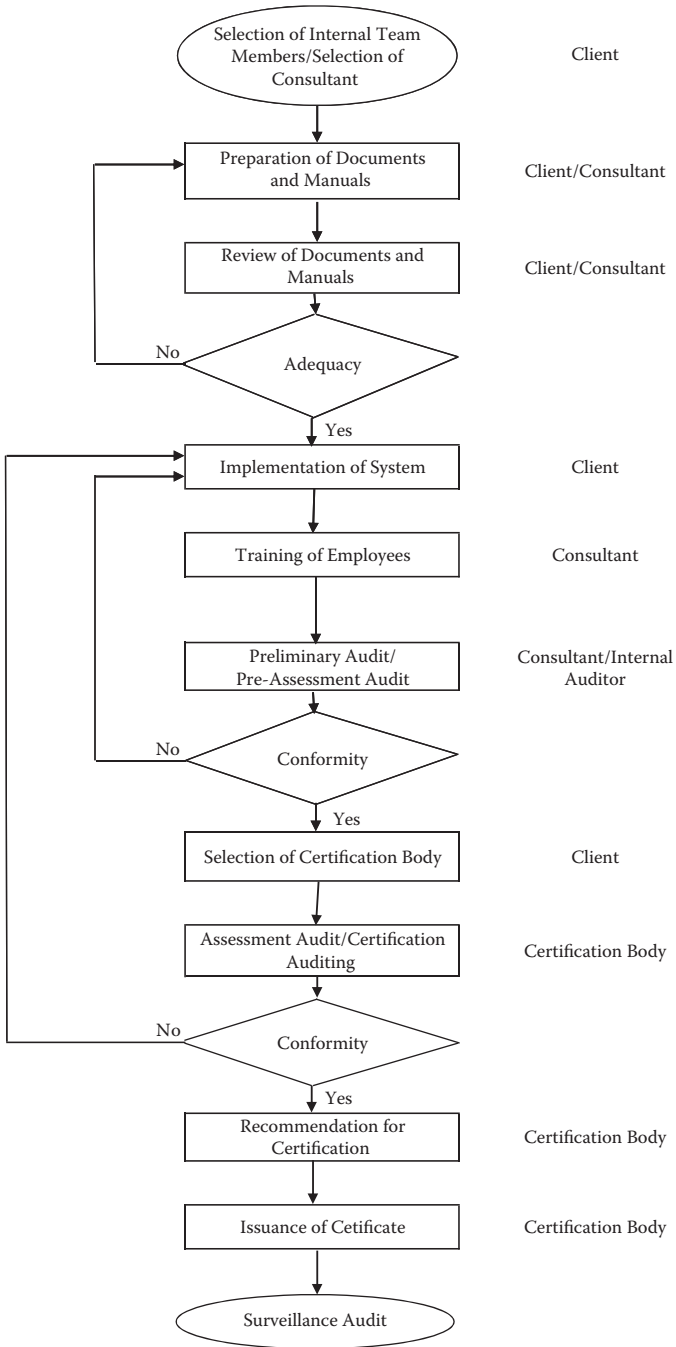

FIGURE 2.2 ISO certification process diagram.

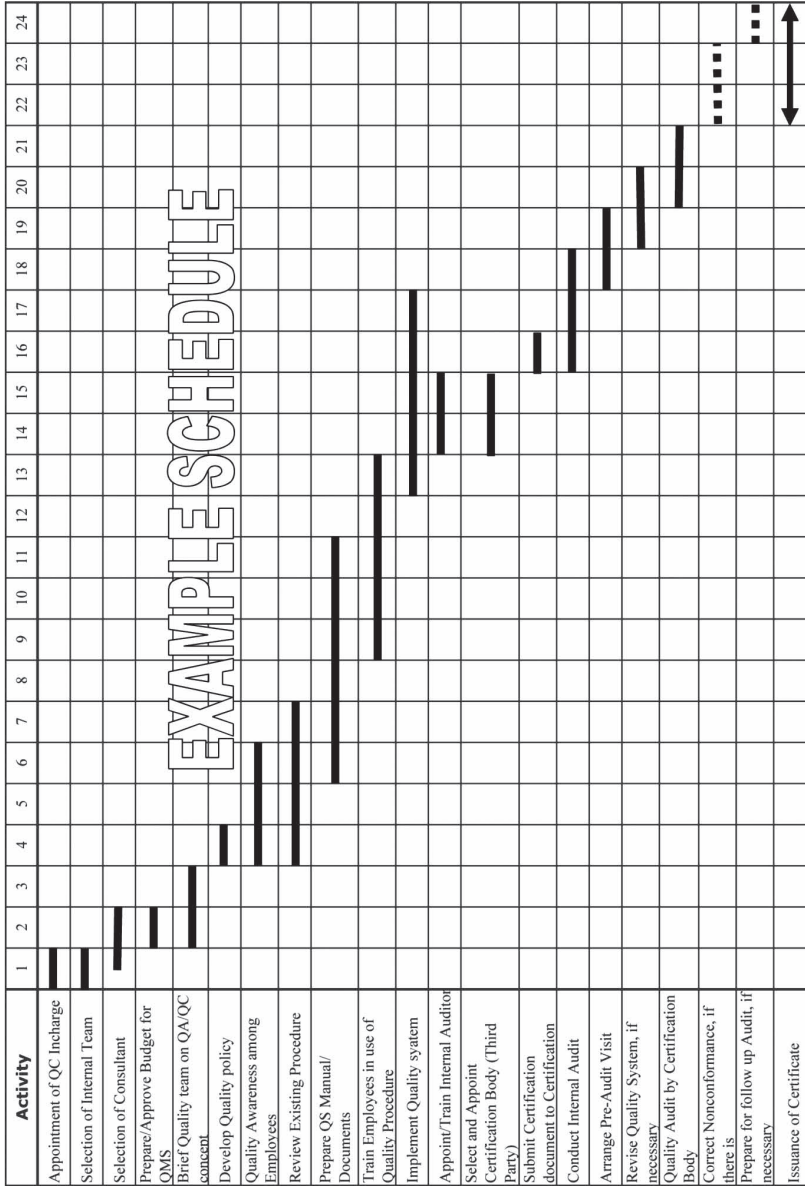

FIGURE 2.3 QMS certification schedule.

2.7 ISO 14000 Environmental Management System

ISO 14000 is a series of international standards that have been developed to incorporate environmental aspects into business operations and product standards. ISO 14001 is a specific standard in the series for a management system that incorporates a set of interrelated elements designed to minimize harmful effects on the environment due to the activities performed by an organization, and to achieve continual improvement of its environmental performance. ISO 14001 incorporates quality management system philosophy, terminology, and requirement structure similar to that of ISO 9001 and provides system compatibility.

2.7.1 Benefits of ISO 14000

The following are the benefits of implementing an environmental management system:

- Pollution prevention and waste reduction opportunities
- Cost reduction
- Customer satisfaction
- Compliance with regulatory requirements on environmental considerations
- Reduction in consumption of energy
- Reduction in use of natural resources
- Minimization of environmental liability and risk
- Commitment to social responsibility

2.8 Occupational Health and Safety Assessment Series (OHSAS) 18000

The Occupational Health and Safety Assessment Series (OHSAS) 18000 has been developed to help organizations control and minimize occupational health and safety risks. OHSAS 18001 is a specific standard for occupational health and safety management systems designed to eliminate or minimize the risk to employees and other related parties who may be exposed to occupational health and safety risks associated with business activities. OHSAS 18000 is compatible with ISO 9001 and ISO 14001 management systems. OHSAS 18001 represents a progression of a management philosophy from quality management to environmental management to occupational health and safety management.

2.8.1 Benefits of OHSAS Management System

The benefits of implementing an OHSAS management system are

- Reduced accidents and injuries to the employees
- Reduced insurance liability and risk
- Decreased costs due to personal injury and production downtime
- Reduced worker compensation insurance costs
- Ease of managing safety risks
- Enhanced employee safety awareness

2.9 Integrated Quality Management

The integrated quality management system (IQMS) is the integration and proper coordination of functional elements of quality to achieve efficiency and effectiveness in implementation and maintaining an organization's quality management system to meet customer requirements and satisfaction. IQMS consists of any element or activity that has an effect on quality. Customer satisfaction is the goal of quality objectives.

During the past three decades, many programs have been implemented for organizational improvements. In the 1980s programs such as statistical process control, various quality tools, and total quality management were implemented. In the 1990s ISO 9000 came into being, which resulted in improved productivity, cost reduction, improved time, improved quality, and customer satisfaction.

With globalization and competition, it became necessary for organizations to continuously improve to achieve the highest performance and a competitive advantage.

In the 1980s, the major challenge facing most organizations was to improve quality. In the 1990s, it was to improve faster by restructuring and reengineering all operations.

In today's global competitive environment, organizations are facing many challenges due to an increase in customer demand for higher performance requirements at a competitive cost. They are finding that their survival in the competitive market is increasingly in doubt. To achieve a competitive advantage, effective quality improvement is critical.

Processes and systems are essential for the performance and expansion of any organization. ISO 9000 is an excellent tool to develop a strong foundation for good processes and systems. The ISO 9000 quality management system is accepted worldwide, and ISO 9000 certification has global recognition.

An IQMS is developed by merging recommendations and specifications from ISO 9000 (Quality Management System), ISO 14000 (Environmental Management System), and OHSAS 18000 (Occupational Health and Safety Management) together with other contract documents. If an organization has a certified Quality Management System (ISO 9000), it can build an IQMS system by adding environmental, health, safety, and other requirements of management system standards.

The benefits of implementing an IQMS are

- Reduced duplication and, therefore, cost
- Improved resource allocation
- Standardized process
- Elimination of conflicting responsibilities and relationship
- Consistency
- Improved communication
- Reduced risk and increase profitability
- Facilitated training development
- Simplified document maintenance
- Reduced record keeping
- Ease of managing legal and other requirements

Construction projects are unique and nonrepetitive in nature, and have their own quality requirements that can be developed by integration of project specifications and an organization's quality management system. Normally, quality management system manuals consist of procedures to develop project quality control plans, taking into consideration contract specifications. This plan is called the Contractor's Quality Control Plan (CQCP). Certain projects specify which value engineering studies should be undertaken during the construction phase. The contractor is required to include these while developing the CQCP. This plan can be termed an Integrated Quality Management System (IQMS) for construction projects. The contractor has to implement a quality system to ensure that the construction is carried out in accordance with the specification details and approved CQCP. Figure 2.4 illustrates the logic flow diagram for development of IQMS for construction projects.

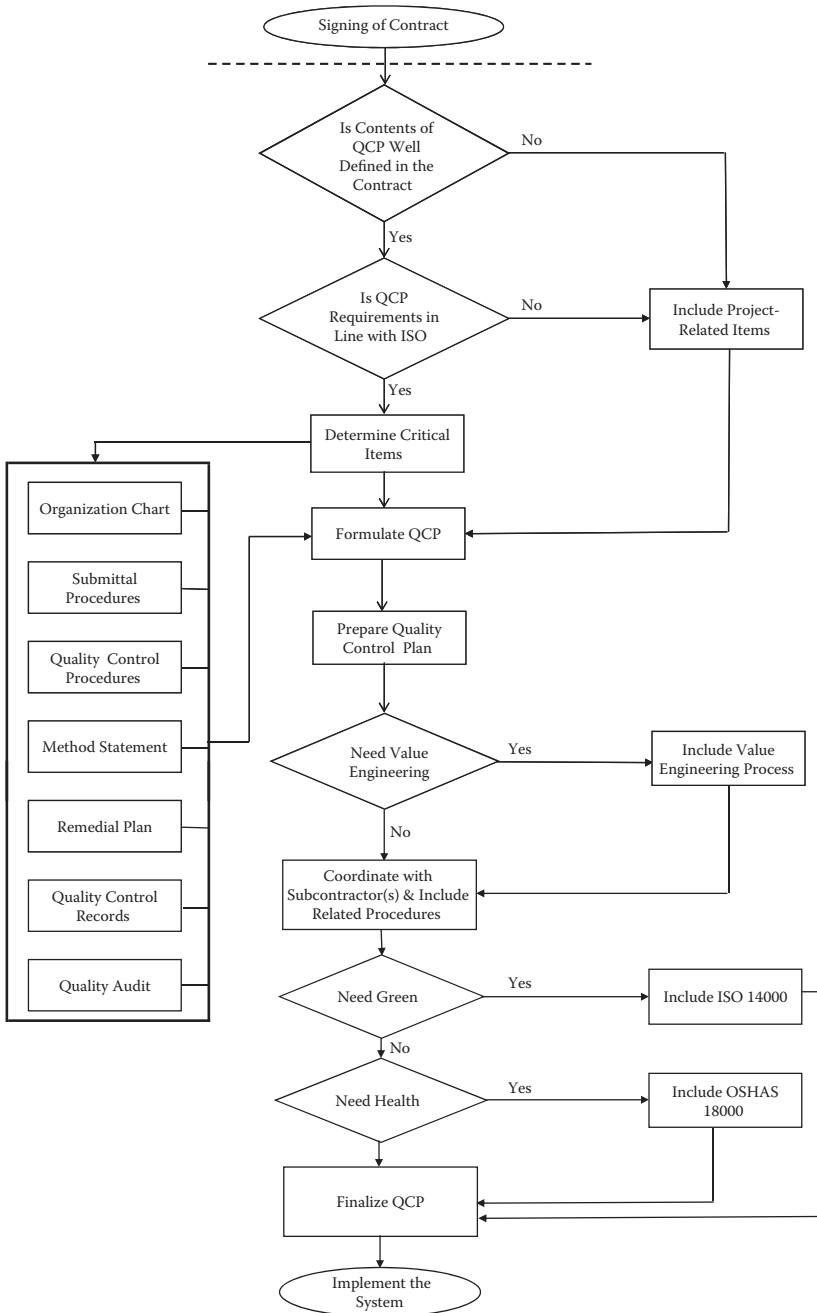

FIGURE 2.4 Logic flow diagram for development of IQMS.

3

Construction Projects

3.1 Project Definition

The authors of *A Guide to the Project Management Body of Knowledge* (PMBOK 2000) define the word *project* in term of its distinctive characteristics: “A project is a temporary endeavor undertaken to create a unique product or service.” “Temporary” means that every project has a definite beginning and a definite end. “Unique” means that the product or service is different in some distinguishing way from all similar products or services.

It further states that projects are often critical components of the performing organization business strategy. Examples of projects include

- Developing a new product or service
- Effecting a change in structure, staffing, or style of an organization
- Designing a new transportation vehicle/aircraft
- Developing or acquiring a new or modified information system
- Running a campaign for political office
- Implementing a new business procedure or process
- Constructing a building or facility

The duration of a project is finite; projects are not ongoing efforts, and the project ceases when its declared objectives have been attained. Among other shared characteristics, projects are

1. Performed by people
2. Constrained by limited resources
3. Planned, executed, and controlled

Pyzdek (1999) defined “project” as

1. A plan or proposal; a scheme
2. An undertaking requiring concerted effort

The “plan” is defined as

1. A scheme, program or method worked beforehand for the accomplishment of an objective; a plan of attack
2. A proposed or tentative projective or course of action
3. A systematic arrangement of important parts (p. 48)

According to Kerzner (2001), a project can be considered to be a set of activities and tasks that

- Have a specified objective to be completed within certain specifications
- Have defined start and end dates
- Have funding limits (if applicable)
- Consume human and nonhuman resources (i.e., money, people, and equipment)
- Are multifunctional (i.e., cut across several lines) (p. 2)

Based on various definitions, the project can be defined as follows: “A project is a plan or program performed by the people with assigned resources to achieve an objective within a finite duration.”

3.2 Construction Projects

Construction has a history of several thousand years. The first shelters were built from stone or mud and the materials collected from the forests to provide protection against cold, wind, rain, and snow. These buildings were primarily for residential purposes, although some may have had some commercial function.

During the New Stone Age, people introduced dried bricks, wall construction, metal working, and irrigation. Gradually people developed the skills to construct villages and cities, and considerable skills in building were acquired. This can be seen from the great civilizations in different parts of the world—some 4000–5000 years ago. During the early period of Greek settlement, which was about 2000 BCE, the buildings were made of mud using timber frames. Later, temples and theaters were built from marble. Some 1500–2000 years ago Rome became the leading center of world culture, which extended to construction.

Marcus Vitruvius Pollo, the 1st century military and civil engineer, penned in Rome the world’s first major treatise on architecture and construction. It

dealt with building materials, the styles and design of building types, the construction process, building physics, astronomy, and building machines.

During the Middle Ages (476–1492), improvements occurred in agriculture and artisanal productivity and exploration, and as a consequence, the broadening of commerce took place and in the late Middle Ages, building construction became a major industry. Craftsmen were given training and education in order to develop skills and to raise their status. At this time guilds came up to identify true craftsmen and set standards for quality.

The 15th century brought a “renaissance” or renewal in architecture, building, and science. Significant changes occurred during the 17th century and thereafter due to the increasing transformation of construction and urban habitat.

The scientific revolution of the 17th and 18th centuries gave birth to the great Industrial Revolution of the 18th century. After some delay, construction followed these developments in the 19th century.

The first half of the 20th century witnessed the construction industry becoming an important sector throughout the world, employing many workers. During this period skyscrapers, long-span dams, shells, and bridges were developed to satisfy new requirements and marked the continuing progress of construction techniques. The provision of services such as heating, air conditioning, electrical lighting, water mains, and elevators in buildings became common. The 20th century has seen the transformation of the construction and building industry into a major economic sector. During the second half of the 20th century, the construction industry began to industrialize, introducing mechanization, prefabrication, and system building. The design of building services systems changed considerably in the last 20 years of the 20th century. It became the responsibility of designers to follow health, safety, and environmental regulations while designing any building.

Building and commercial—traditional A&E type—construction projects account for an estimated 25% of the annual construction volume. Building construction is a labor-intensive endeavor. Every construction project has some elements that are unique. No two construction or R&D projects are alike. Though it is clear that many building projects are more routine than research and development projects, some degree of customization is a characteristic of the projects.

Construction projects involve a cross section of many different participants. These both influence and depend on each other in addition to the “other players” involved in the construction process. Figure 3.1 illustrates the concept of the traditional construction project organization.

Traditional construction projects involve three main groups. These are

1. Owners—A person or an organization that initiates and sanctions a project. He/she outlines the needs of the facility and is responsible for arranging the financial resources for creation of the facility.

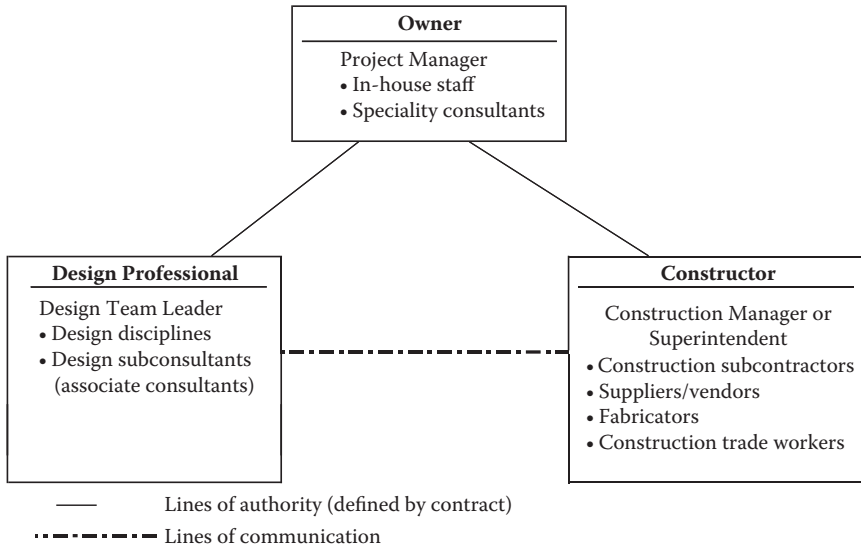
**FIGURE 3.1**

Traditional construction project organization. (From American Society of Civil Engineers, *Quality in the Constructed Project*, 2000. Reprinted with permission from ASCE.)

2. Designers (A&E)—This group consists of one or more architects or engineers and consultants. They are the owner's appointed entities accountable for converting the owner's conception and need into a specific facility with detailed directions through drawings and specifications adhering to the economic objectives. They are responsible for the design of the project and in certain cases its supervision.
3. Contractors—A construction firm engaged by the owner to complete the specific facility by providing the necessary staff, work force, materials, equipment, tools, and other accessories to the satisfaction of the owner/end user in compliance with the contract documents. The contractor is responsible for implementing the project activities and for achieving the owner's objectives.

Construction projects are executed based on a predetermined set of goals and objectives. With traditional construction projects, the owner heads the team, designating a project manager. The project manager is a person/member of the owner's staff or independently hired person/firm with overall or principal responsibility for the management of the project as a whole.

Oberlender (2000) states that the working environment and culture of a construction project is unique compared to most working conditions. A typical construction project consists of a group of people, normally from several organizations, that are hired and assigned to a project to build the facility.

Due to the relatively short life of a construction project, these people may view the construction project as accomplishing short-term tasks. However, the project manager of the construction team must instill in the team the concept that building a long-term relationship is more important in career advancement than trying to accomplish short-term tasks.

In certain cases owners engage a professional firm, called a construction manager, trained in the management of construction processes, to assist in developing bid documents, and overseeing and coordinating the project for the owner. The basic construction management concept is that the owner assigns a contract to a firm that is knowledgeable and capable of coordinating all the aspects of the project to meet the intended use of the project by the owner. In the construction management type of construction projects, the consultants (architect/engineer) prepare complete design drawings and contract documents, then the project is put for competitive bid and the contract is awarded to the competitive bidder (contractor). Next, the owner hires a third-party (construction manager) to oversee and coordinate the construction.

The authors of "Quality in the Constructed Project" by the American Society of Civil Engineers (ASCE; 2000) have categorized two types of construction managers: agency construction managers (ACM) and construction managers-at-risk (CM-at-risk). An ACM functions wholly within the policies, procedures, and practices of the owner's organization. A CM-at-risk typically contracts with the owner in two stages. During the first stage, CM-at-risks act as consultants or even design professionals, and when the design is completed they become involved in the completion of the construction work.

There are numerous types of construction projects:

Process Type Projects

- Liquid chemical plants
- Liquid/solid plants
- Solid process plants
- Petrochemical plants
- Petroleum refineries

Nonprocess Type Projects

- Power plants
- Manufacturing plants
- Support facilities
- Miscellaneous (R&D) projects
- Civil construction projects
- Commercial/A&E projects

Civil construction projects and commercial/A&E projects can further be categorized into four somewhat arbitrary but generally accepted major types of construction. These are

1. Residential construction
2. Building construction (institutional and commercial)
3. Industrial construction
4. Heavy engineering construction

Residential construction: Residential construction includes single-family homes, multiunit town houses, garden, apartments, high-rise apartments, and villas.

Building construction: Building construction includes structures ranging from small retail stores to urban redevelopment complexes, from grade schools to new universities, hospitals, commercial office towers, theaters, government buildings, recreation centers, warehouses, and neighborhood centers.

Industrial construction: Industrial construction includes petroleum refineries, petroleum plants, power plants, heavy manufacturing plants, and other facilities essential to our utilities and basic industries.

Heavy engineering construction: Heavy engineering construction includes dams and tunnels, bridges, railways, airports, highways and urban rapid transit system, ports and harbors, water treatment and distribution, sewage and storm water collection, treatment and disposal system, power lines, and communication network.

Table 3.1 shows a brief classification of projects/characteristics.

3.3 Construction and Manufacturing

Construction has unique problems compared to manufacturing. A few of these are listed as follows:

- The construction is a custom rather than a routine, repetitive business and differs from manufacturing.
- Quality in manufacturing passes through series of processes. The output is monitored by inspection and testing at various stages of production.
- Construction is different from both that of mass production and batch (lot) production manufacturing.
- In construction projects, the scenario is not the same as that of manufacturing. If anything goes wrong, the nonconforming work is very difficult to rectify and remedial action is sometimes not possible. Quality costs play an important role in construction projects.

- In construction, an activity may be repeated at various stages, but it is done only one time for a specific work. Therefore, it has to be right from the onset.
- In manufacturing, the buyer does not enter the scene until the product comes into being, whereas in construction the buyer is involved from beginning to end. Even during the construction phase, it is likely that certain modifications may take place.
- The owner is deeply involved in the construction process, while the purchaser of manufactured goods is not. Buyers of the usual manufactured products seldom have access to the plant where they are made, nor do they deal directly with factory managers.
- Most projects or their individual work phases are of relatively short duration. One consequence is that management teams and possibly the work force must be assembled quickly and cannot be shaken out or restructured before the project or work phase is completed.
- To a great extent, each project has to be designed and built to serve a specific need and therefore it is necessary to make certain modifications in the system process to fit the particular conditions of each construction project and its specific problems.
- The location of construction projects varies widely. In a manufacturing plant a given operation is assigned to and carried out in one place. In contrast, specialized construction crews progress from location to location.
- Operations are commonly conducted out of doors and are subject to all the interruptions and variation in conditions and the other difficulties that rain, snow, heat, and cold can introduce.
- The final product is usually of unique design and differs from workstation to workstation so that no fixed arrangement of equipment or aids such as jigs and fixtures are possible as is in the case of manufacturing.
- The construction is a preliminary step leading to a completed facility; the layout and arrangements may make access for construction difficult and permanent provisions for safety impossible.
- The construction often needs highly skilled craftsmen rather than unskilled workers; individual crews, whether union or nonunion, usually do specialized operations.
- Construction involves installation and integration of various materials, equipment, systems, or other components to complete the facility.
- Construction focuses mainly on overall performance of the project or facility in which a product(s) or a system(s) is a part and assembled/installed to achieve the objectives.

- Construction projects work against defined scope, schedules, and budget to achieve the specified result.
- Performance of construction projects can be evaluated only after it is completed and put into use/operation.

3.4 Quality Cost

3.4.1 Introduction

Quality has an impact on the costs of products and services. The cost of poor quality is the annual monetary loss of products and processes that are not achieving their quality objective.

According to Gryna (2001) the concept of quality costs emerged during the 1950s, and different people assigned different meaning to the term. Some people equated quality costs with the costs of attaining quality; some people equated the term with the extra costs incurred because of poor quality (p. 19). He further states that

The cost of poor quality is the annual monetary loss of products and processes that are not achieving their quality objectives. The main components of the cost of low quality are

1. Cost of nonconformities.
2. Cost of inefficient processes.
3. Cost of loss opportunities of sales revenue. (p. 20)

Juran and Godfrey (1999) also state that “the term *quality costs* has different meanings to different people. Some equate quality costs with the cost of poor quality (mainly the costs of finding and correcting defective work); others equate the term with the costs to attain quality; still others use the term to mean the costs of running the quality department” (p. 8.2).

3.4.2 Categories of Costs

Costs of poor quality are the costs associated with providing poor-quality products or services. These are costs that would not be incurred if things were done right from the start time and at every stage thereafter in order to achieve the quality objective. There are four categories of costs:

1. Internal failure costs. (The costs associated with defects found before the customer receives the product or service. It also consists of cost of failure to meet customer satisfaction and needs and cost of inefficient processes.)

2. External failure costs. (The costs associated with defects found after the customer receives the product or service. Also includes lost opportunity for sales revenue.)
3. Appraisal costs. (The costs incurred to determine the degree of conformance to quality requirements.)
4. Prevention costs. (The costs incurred to keep failure and appraisal costs to minimum).

Thomas Pyzdek (1999) has detailed these costs as follows:

1. Prevention costs: Costs incurred to prevent the occurrence of nonconformances in the future. Examples of prevention costs include
 - Quality planning
 - Process control planning
 - Design review
 - Quality training
 - Gage design
2. Appraisal costs: Costs incurred in measuring and controlling concurrent production to assure conformance to requirements. Examples of appraisal costs are
 - Receiving inspection
 - Laboratory acceptance testing
 - In-process inspection
 - Outside endorsements (e.g., UL approval)
 - Calibration
 - Inspection and test equipment
 - Field testing
3. Internal failure costs: Costs generated before a product is shipped as a result of nonconformance to equipment. Examples of internal failure costs include
 - Scrap
 - Rework
 - Process troubleshooting
 - Vendor-caused scrap or work
 - Material review board activity

Reinspection or retest

Downgrading

4. External failure costs: Costs generated after a product is shipped as a result of nonconformance to requirement. Examples of external failure costs include

Processing of customer complaints

Service

Unplanned field repair

Recalls

Processing of returned materials

Warranty (p. 148)

These cost categories allow the use of quality cost data for a variety of purposes. Quality costs can be used for measurement of progress, for analyzing the problem, or for budgeting. By analyzing the relative size of the cost categories, the company can determine if its resources are properly allocated.

CII product no. EM-4A (1994) states that “the cost of quality is the penalty paid for an imperfect world. It is the costs of all the extra work we do beyond merely doing a task correctly the first time to meet the requirements and expectations. The simple formula for defining the cost of quality is

Cost of Quality = Cost of Prevention and Appraisal + Cost of Deviation Correction” (p. 13).

It has further elaborated the components of costs of quality as follows:

Prevention and appraisal: All measures taken to assure that requirements are met, such as quality control systems, inspection, work checking, design review, constructability or maintainability review, shop inspection, and auditing.

Deviation correction: Work done more than once because it did not meet requirements the first time.

3.4.3 Reasons for Poor Quality

According to the survey carried out by CII, the primary reasons for poor quality are mainly due to poor management and are illustrated in Figure 3.2.

Per Ireland (1991), cost of quality is the total price of all efforts to achieve product or service quality. This includes all work to build a product or service that conforms to the requirements as well as work resulting from nonconformance to the requirements. The general areas of costs for a quality system are illustrated in Table 3.2.

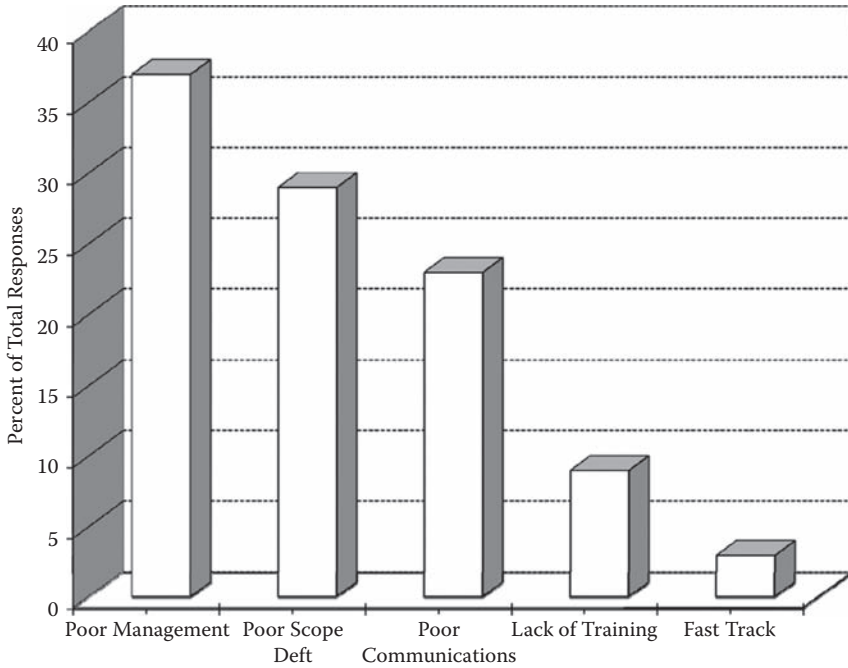

FIGURE 3.2 Primary reasons for poor quality (139 responses). (From CII, Source 79. Reprinted with permission of CII, University of Texas.)

TABLE 3.2

Conformance versus Nonconformance Costs

Cost of Conformance	Cost of Nonconformance
<ul style="list-style-type: none"> • Planning • Training and indoctrination • Field testing • Product design validation • Process validation • Test and evaluation • Quality audits • Maintenance and calibration • Other 	<ul style="list-style-type: none"> • Scrap • Rework • Expedition • Additional material or inventory • Warranty repairs or service • Complaint handling • Liability judgments • Product recalls • Productive corrective actions

Source: Ireland, L.R. (1991). *Quality Management for Projects & Programs*. Reprinted with permission from PMI.

Figure 3.3 shows the expected results of the total quality management system on quality cost. It shows that by increasing prevention costs, that is, doing things that will prevent problems, reduces the cost of appraisal and failure and gain a net cost benefit to the organization. CII has made the following recommendations to reduce the rework:

1. Reduce the number of design changes
2. Implement a quality management program
3. Adopt the standard set of quality related terminology
4. Develop and implement system to establish a database
5. Implement a QPMS

Chung (1999) has quoted (Robert, 1991) that “quality does not cost—it pays” (p. 9). Figure 3.4 summarizes the quality-related costs expressed as a percentage of total construction costs. He further states that through the implementation of a proactive quality system that costs about 1% of the project value (the prevention cost), the expenditure as a result of repair, and so forth (failure cost) drops from 10% to 2% representing a saving of 7%. These categories of costs may represent an increase of cost in one area and a reduction of cost in another.

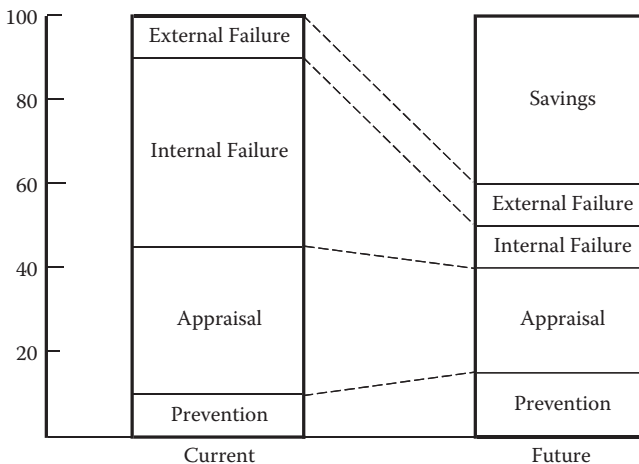
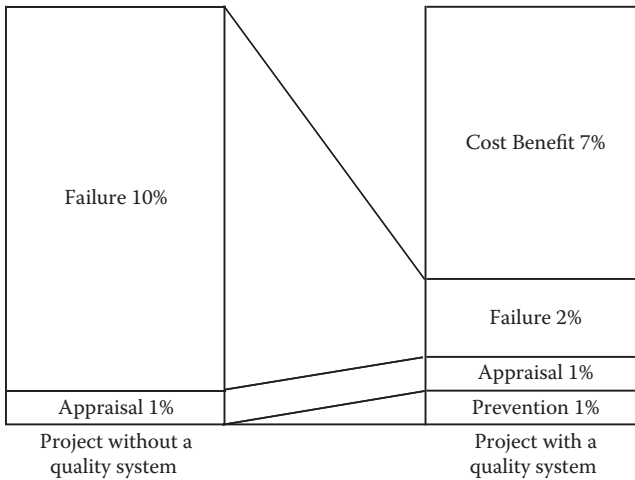

FIGURE 3.3 Total quality cost. (From H. Kerzner, *Project Management*, 2001. Reprinted with permission from John Wiley & Sons.)

**FIGURE 3.4**

Implementation of quality management. (From H.W. Chung, *Understanding Quality: Assurance in Construction*, 1999. Reprinted with permission from Cengage Learning Services Limited.)

3.4.4 Quality Cost in Construction

Quality of construction is defined as

1. Scope of work
2. Time
3. Budget

Cost of quality refers to the total cost incurred during the entire life cycle of construction project in preventing nonconformance to owner requirements (defined scope). There are certain hidden costs that may not directly affect the overall cost of the project; however, it may cost the consultant/designer to complete the design within the stipulated schedule to meet owner requirements and conformance to all the regulatory codes/standards, and for the contractor to construct the project within the stipulated schedule meeting all the contract requirements. Rejection/nonapproval of executed/installed works by the supervisor due to noncompliance with specifications will cause the contractor loss in terms of

- Material
- Manpower
- Time

The contractor shall have to rework or rectify the work, which will need additional resources and will need extra time to do the work as specified.

This may disturb the contractor's work schedule and affect execution of other activities. The contractor has to emphasize the "Zero Defect" policy, particularly for concrete works. To avoid rejection of works, the contractor has to take the following measures:

1. Execution of works per approved shop drawings using approved material
2. Following approved method of statement or manufacturer's recommended method of installation
3. Conduct continuous inspection during construction/installation process
4. Employ properly trained workforce
5. Maintain good workmanship
6. Identify and correct deficiencies before submitting the checklist for inspection and approval of work
7. Coordinate requirements of other trades, for example, if any opening is required in the concrete beam for crossing of services pipe

Timely completion of a project is one of the objectives to be achieved. To avoid delay proper planning and scheduling of construction activities are necessary. Since construction projects have the involvement of many participants, it is essential that the requirements of all the participants are fully coordinated. This will ensure execution of activities as planned resulting in timely completion of the project.

Normally, the construction budget is fixed at the inception of the project, therefore it is necessary to avoid variations during the construction process as it may take time to get approval of an additional budget resulting in time extension to the project. Quality costs related to construction projects can be summarized as follows:

Internal Failure Costs

- Rework
- Rectification
- Rejection of checklist
- Corrective action

External Failure Costs

- Breakdown of installed system
- Repairs
- Maintenance
- Warranty

Appraisal Costs

- Design review/preparation of shop drawings
- Preparation of composite/coordination drawings
- On-site material inspection/test
- Off-site material inspection/test
- Pre-checklist inspection

Prevention Costs

- Preventive action
- Training
- Work procedures
- Method statement
- Calibration of instruments/equipment

Quality costs during the design phases are different from those of the construction phase. Costs of quality during design phases are mainly to ensure development of project design and documents to ensure conformance to the client's requirements/TOR (Terms of Reference)/Matrix of Owner's Requirements. Quality costs related to design development/contract documents of construction projects can be summarized as follows:

Internal Failure Costs

- Redesign/redraw to meet requirements of other trades
- Redesign/redraw to meet fully coordinated design
- Rewrite specifications/documents to meet requirements of all other trades

External Failure Costs

- Incorporate design review comments by client/project manager
- Incorporate specifications/documents review comments by client/project manager
- Incorporate comments by regulatory authority(ies)
- Resolve RFI (Request for Information) during construction

Appraisal Costs

- Review of design drawings
- Review of specifications
- Review of contract documents to ensure meeting owner's needs, quality standards, constructability, and functionality
- Review for regulatory requirements, codes

Prevention Costs

- Conduct technical meetings for proper coordination
- Follow quality system
- Meeting submission schedule
- Training of project team members
- Update of software used for design

3.4.5 Quality Performance Management System

Quality performance management system (QPMS) is a product of the Construction Industry Institute (CII). QPMS is one of the tools available for a TQM project and is a good implementation tool for a project to utilize in a TQM environment. It is a management tool developed by CII to give management the information necessary to identify quality improvement opportunities.

QPMS focuses on reducing the cost of quality in four ways:

1. It provides a process that facilitates awareness of individual and group quality performance (how well we do things right) by measuring these costs in dollars.
2. It arms managers with information on quality costs and activities that enable proactive decisions affecting quality outcome.
3. It provides a database for estimating quality performance on future projects.
4. If and when widely accepted, the data should provide benchmarking information throughout the industry. (Benchmarking is a point of reference by which the performance is judged or measured.)

According to CII, the QPMS has been developed as a management tool to meet the following criteria. It must

1. Be capable of tracking quality-related costs are involved in the design and construction of engineered projects and answer the following four questions:
What quality management activities and deviation costs are involved?
When were the quality management activities and deviation costs incurred?
Why did the deviations occur (i.e., their root causes)?
How did the rework relate to the quality management?
2. Provide valuable cost-of-quality information to establish baseline and identify opportunities for improvement, without providing either too much or too little detail

3. Be adaptable to various types and aspects of design and construction projects
4. Be easily implementable by owners, designers, and contractors
5. Be cost effective
6. Be compatible with existing cost systems used by management

Thus, it can be summarized that with implementation of quality management system, costs of quality is reduced and ultimately result in savings.

3.5 Systems Engineering

3.5.1 Introduction

Systems are pervasive throughout the universe in which we live. This world can be divided into the natural world and the human-made world. Systems appeared first in natural forms and subsequently with the appearance of human beings. Systems were created based on components, attributes, and relationships.

Systems engineering and analysis, when coupled with new emerging technologies, reveal unexpected opportunities for bringing new improved systems and products into being that will be more competitive in the world economy. Product competitiveness is desired by both commercial and public-sector producers worldwide to meet consumer expectations. These technologies and processes can be applied to construction projects. The systems engineering approach to construction projects help us understand the entire process of project management in order to manage its activities at different levels of various phases to achieve economical and competitive results. The cost effectiveness of the resulting technical activities can be enhanced by giving more attention to what they are to do, before addressing what they are composed of. To ensure economic competitiveness regarding the product, engineering must become more closely associated with economics and economic facilities. This is best accomplished through the life-cycle approach to engineering.

Experience in recent decades indicates that properly coordinated and functioning human-made systems will result in a minimum of undesirable side effects through the application of this integrated, life-cycle oriented "systems" approach. The consequences of not applying systems engineering in the design and development and/or reengineering of systems have been disruptive and costly.

The systems approach is a technique, which represents a broad-based systematic approach to problems that may be interdisciplinary. It is particularly useful when problems are affected by many factors, and it entails the creation of a problem model that corresponds as closely as possible to

reality. The systems approach stresses the need for the engineer to look for all the relevant factors, influences, and components of the environment that surround the problem. The systems approach corresponds to a comprehensive attack on a problem and to an interest in, and commitment to, formulating a problem in the widest and fullest manner that can be professionally handled.

3.5.2 System Definition

There are many definitions of *system*. One dictionary definition calls it “a group or combination of interrelated, independent or interacting elements forming a collective entity.” A system is an assembly of components or elements having a functional relationship to achieve a common objective for useful purpose. A system is composed of components, attributes, and relationships. These are described as follows:

1. Components are the operating parts of the system consisting of input, process, and output. Each system component may assume a variety of values to describe a system state, as set by some control action and one or more restrictions.
2. Attributes are the properties or discernible manifestations of the components of a system. These attributes characterize the system.
3. Relationships are the links between components and attributes.

The properties and behavior of each component of the set have an effect on the properties and behavior of the set as a whole and depend on the properties and behavior of at least one other component on the list. The components of the system cannot be divided into independent subsets. A system is more than the sum of its components and parts. Not every set of items, facts, methods, or procedures is a system. To qualify the system, it should have a functional relationship, interaction between many components and useful purpose. The purposeful action performed by a system is its function. A basic behavioral concept of a system is that it is a device, which accepts one or more inputs and generates from them one or more outputs. This simple behavioral approach to systems is generally known as the Black Box and is represented schematically in Figure 3.5. The Black Box system phenomenon establishes the functional relationship between system inputs and outputs.

Every system is made up of components and components that can be broken down into similar components. If two hierarchical levels are involved in a given system, the lower is conveniently called a subsystem. The designation of system, subsystem, and components are relative because the system at one level in the hierarchy is the component at another level. Everything that remains outside the boundaries of the system is considered to be environmental.

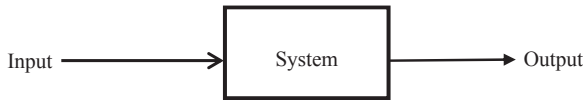

FIGURE 3.5
Black Box.

Material, energy, and/or information that pass through the boundaries are called “inputs” to the system. In reverse, material, energy, and/or information that pass from the system to the environment is called output.

Accordingly, a system is an assembly of components or elements having a functional relationship to achieve a common objective for a useful purpose.

3.5.3 Systems Engineering

INCOSE (International Council on Systems Engineering) defines systems engineering as follows:

An interdisciplinary approach and means to enable the realization of successful system. It focuses on defining customer needs and required functionality early in the development cycle, documenting requirements, the proceeding with design synthesis and system validation while considering the complete problem:

- Operations
- Test
- Cost and schedule
- Disposal
- Performance
- Manufacturing
- Training and support

Systems Engineering integrates all the disciples and specialty groups into a team effort forming a structural development process that proceeds from concept to production to operation. Systems Engineering considers both the business and the technical needs of all customers with the goal of providing a product that meets the user needs.

The system life cycle process is illustrated in Figure 3.6 and is fundamental to the application of system engineering.

The life cycle begins with the identification of need and extends through conceptual and preliminary design, detail design, and development, production and/or construction, product use, phase-out, and disposal. The program phases are classified as acquisition and utilization to recognize procedure and customer activities. This classification represents a generic approach. Sometimes the acquiring process may involve both the customer and the producer (or contractor), whereas acquiring may include a combination of contractor and consumer (or ultimate user) activities.

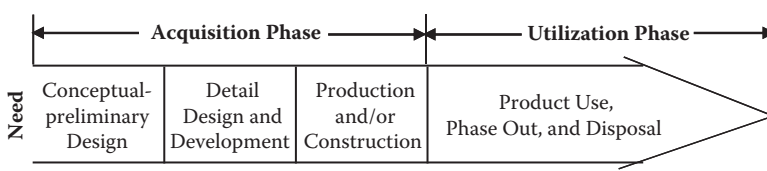

FIGURE 3.6
The product life cycle. (From B.S. Blanchard, W.J. Fabrycky, and J. Wolter, *Systems Engineering and Analysis*, 1998. Reprinted with permission from Pearson Education, Inc.)

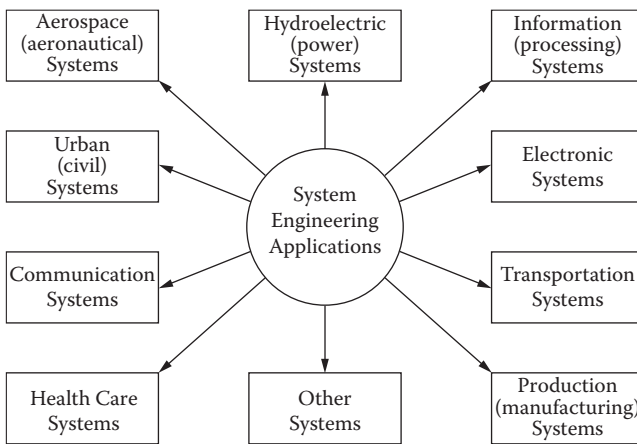

FIGURE 3.7
Application areas of systems engineering. (From B.S. Blanchard, W.J. Fabrycky, and J. Wolter, *Systems Engineering and Analysis*, 1998. Reprinted with permission from Pearson Education, Inc.)

In general, engineering has focused mainly on product performance as the main objective rather than on development of overall system of which the product is a part. Application of a systems engineering process leads to reduction in the cost of design development, production/construction, and operation, and hence results in reduction in life cycle cost of the product; thus, the product becomes more competitive and economical. Systems engineering provides the basis for a structural and logical approach. The need for systems engineering increases with the size of projects. Application areas of systems engineering are illustrated in Figure 3.7.

3.6 Construction Project Life Cycle

Most construction projects are custom-oriented, having a specific need and a customized design. It is always the owner’s desire that his project should

be unique and better. Further it is the owner's goal and objective that the facility is completed on time. Expected time schedule is important from both financial and acquisition of the facility by the owner/user.

The system life cycle is fundamental to the application of systems engineering. Detailed presentations of the elaborate technological activities and interaction that must be integrated over the system life cycle are shown in Figure 3.8. This figure summarizes major technical functions performed during the acquisition and utilization process of the system life cycle.

A systems engineering approach to construction projects helps to understand the entire process of project management and to manage and control its activities at different levels of various phases to ensure timely completion of the project with economical use of resources to make the construction project most qualitative, competitive, and economical.

Systems engineering starts from the complexity of the large-scale problem as a whole and moves toward the structural analysis and partitioning process until the questions of interest are answered. This process of decomposition is called a work breakdown structure (WBS). The WBS is a hierarchical representation of system levels. Being a family tree, the WBS consists of a number of levels, starting with the complete system at level 1 at the top and progressing downward through as many levels as necessary to obtain elements that can be conveniently managed.

Benefits of systems engineering applications are

- Reduction in the cost of system design and development, production/construction, system operation and support, system retirement and material disposal
- Reduction in system acquisition time
- More visibility and reduction in the risks associated with the design decision-making process

Shtub, Bard, and Globerson (1994) have divided the project into five phases as illustrated in Figure 3.9.

Representative construction project life cycle, per Morris has four stages (phases) for construction project and is illustrated in Figure 3.10.

Though it is difficult to generalize project life cycle to system life cycle, considering that there are innumerable processes that make up the construction process, the technologies and processes as applied to systems engineering can also be applied to construction projects. The number of phases shall depend on the complexity of the project. Duration of each phase may vary from project to project. Based on the concept of project life cycle shown in Figure 3.8, Figure 3.9, and Figure 3.10, it is possible to evolve a comprehensive

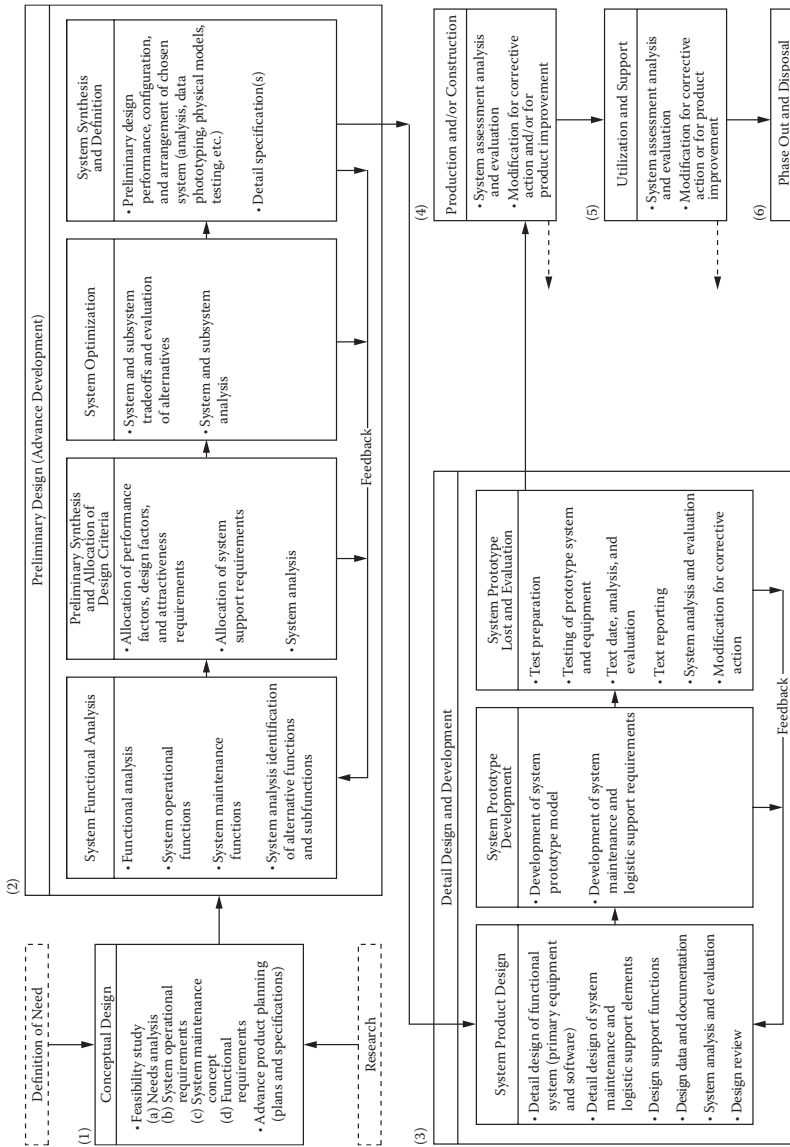

FIGURE 3.8 The system life cycle process. (From B.S. Blanchard, W.J. Fabrycky, and J. Wolter, *Systems Engineering and Analysis*, 1998. Reprinted with permission from Pearson Education, Inc.)

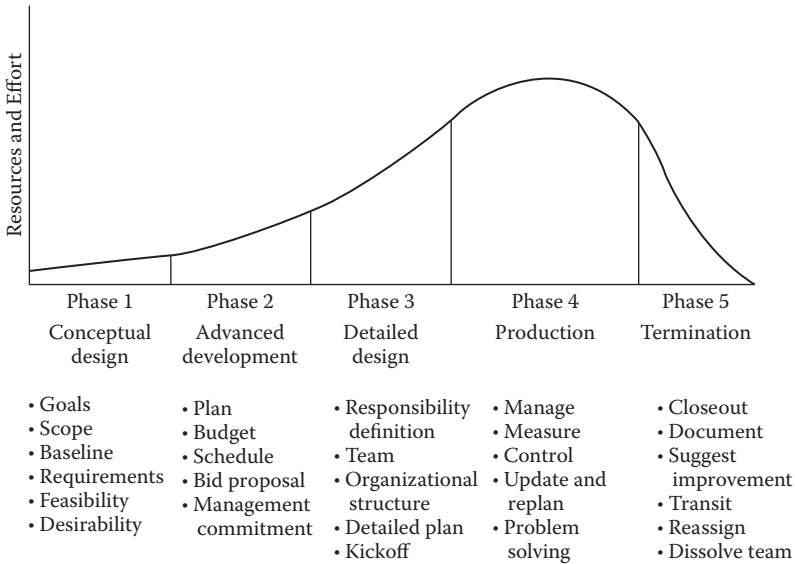

FIGURE 3.9

Project life cycle. (From A. Shtub, J.F. Bard, and S. Globerson, *Project Management*, 1994. Reprinted with permission from Pearson Education, Inc.)

life cycle for construction projects, which may have five of the most common phases. These are as follows:

1. Conceptual design
2. Preliminary design
3. Detailed design
4. Construction
5. Testing, commissioning, and handover

Each phase can further be subdivided into the WBS principle to reach a level of complexity where each element/activity can be treated as a single unit that can be conveniently managed. WBS represents a systematic and logical breakdown of the project phase into its components (activities). It is constructed by dividing the project into major elements with each of these being divided into subelements. This is done until a breakdown is done in terms of manageable units of work for which responsibility can be defined. WBS involves envisioning the project as a hierarchy of goal, objectives, activities, subactivities, and work packages. The hierarchical decomposition of activities continue until the entire project is displayed as a network of separately identified and nonoverlapping activities. Each activity will be single purposed, of a specific time duration, and manageable; its time and cost

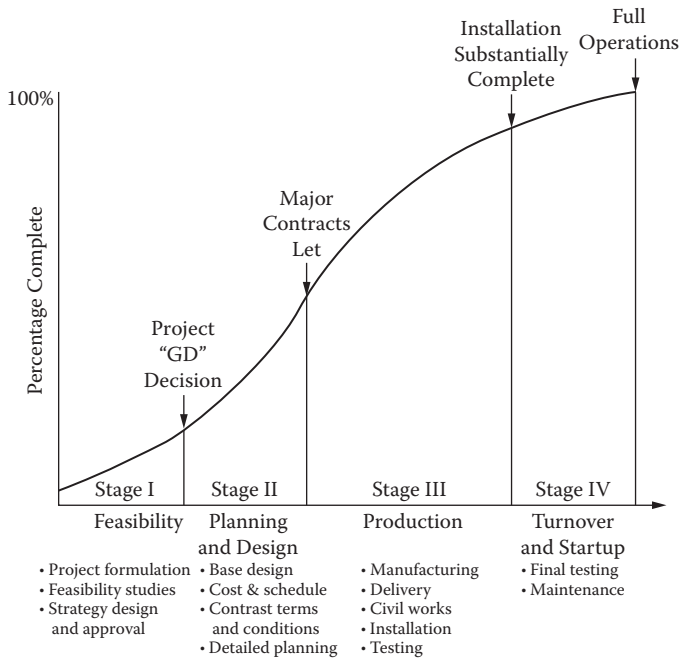

FIGURE 3.10

Representative construction project life cycle. (From Project Management Institute, *PBOK® Guide*, 2004. Reprinted with permission from PMI.)

estimates easily derived, deliverables clearly understood, and responsibility for its completion clearly assigned. The work breakdown structure helps in:

- Effective planning by dividing the work into manageable elements, which can be planned, budgeted, and controlled
- Assignment of responsibility for work elements to project personnel and outside agencies
- Development of control and information system

WBS facilitates the planning, budgeting, scheduling, and control activities for the project manager and its team. By application of WBS phenomenon, the construction phases are further divided into various activities. Division of these phases will improve the control and planning of the construction project at every stage before a new phase starts. The components/activities of construction project lifecycle phases divided on WBS principle are listed as follows:

1. Conceptual Design
 - Identification of need
 - Feasibility

- Identification of project team
 - Identification of alternatives
 - Financial implications/resources
 - Time schedule
 - Development of concept design
2. Preliminary Design
 - General scope of works/basic design
 - Regulatory/authorities' approval
 - Budget
 - Schedule
 - Contract terms and conditions
 - Value engineering study
 3. Detailed Design
 - Detail design of the works
 - Regulatory/authorities' approval
 - Contract documents and specifications
 - Detailed plan
 - Budget
 - Estimated cash flow
 - Tender/bid documents
 4. Construction
 - Mobilization
 - Execution of works
 - Planning and scheduling
 - Management of resources/procurement
 - Monitoring and control
 - Quality
 - Inspection
 5. Testing, commissioning, and handover
 - Testing
 - Commissioning
 - Regulatory/authorities' approval
 - As-built drawings/records
 - Technical manuals and documents

Training of user's personnel
Hand over facility to owner/end user
Move-in-plan
Substantial completion

Table 3.3 illustrates the subdivided activities/components of the construction project life cycle.

These activities may not be strictly sequential, however, the break down allows implementation of project management functions more effectively at different stages.

TABLE 3.3
Construction Project Life Cycle

Conceptual Design	Preliminary Design	Detailed Design	Construction	Testing, Commissioning and Handover
<ul style="list-style-type: none"> • Identification of need • Feasibility 	<ul style="list-style-type: none"> • General scope of work/basic design • Regulatory approval 	<ul style="list-style-type: none"> • Detail design of the works • Regulatory/authorities' approval 	<ul style="list-style-type: none"> • Mobilization • Execution of works 	<ul style="list-style-type: none"> • Testing • Commissioning
<ul style="list-style-type: none"> • Identification of project team 	<ul style="list-style-type: none"> • Budget 	<ul style="list-style-type: none"> • Contract documents and specifications 	<ul style="list-style-type: none"> • Planning and scheduling 	<ul style="list-style-type: none"> • Regulatory/authorities' approval
<ul style="list-style-type: none"> • Identification of alternatives 	<ul style="list-style-type: none"> • Schedule 	<ul style="list-style-type: none"> • Detail plan 	<ul style="list-style-type: none"> • Management of resources/procurement 	<ul style="list-style-type: none"> • As-built drawings/records
<ul style="list-style-type: none"> • Financial implications/resources 	<ul style="list-style-type: none"> • Contract terms and conditions 	<ul style="list-style-type: none"> • Budget 	<ul style="list-style-type: none"> • Monitoring and control 	<ul style="list-style-type: none"> • Technical manuals and documents
<ul style="list-style-type: none"> • Time schedule 	<ul style="list-style-type: none"> • Value engineering study 	<ul style="list-style-type: none"> • Estimated cash flow 	<ul style="list-style-type: none"> • Quality 	<ul style="list-style-type: none"> • Training of user's Personnel
<ul style="list-style-type: none"> • Development of concept design 		<ul style="list-style-type: none"> • Tender/bidding 	<ul style="list-style-type: none"> • Inspection 	<ul style="list-style-type: none"> • Handover of facility to owner/end user • Move-in plan • Substantial completion

4

Quality in Construction Projects

4.1 Quality in Construction Projects

Construction projects are mainly capital investment projects. They are customized and nonrepetitive in nature. Construction projects have become more complex and technical, and the relationships and the contractual grouping of those who are involved are also more complex and contractually varied. The products used in construction projects are expensive, complex, immovable, and long-lived. Generally, a construction project comprises building materials (civil), electromechanical items, finishing items, and equipment. These are normally produced by other construction-related industries/manufacturers. These industries produce products per their own quality management practices complying with certain quality standards or against specific requirements for a particular project. Owners of construction projects or their representatives have no direct control over these companies unless they themselves, their representatives, or appointed contractors commit to buying their product for use in their facility. These organizations may have their own quality management program. In manufacturing or service industries quality management of all in-house manufactured products is performed by the manufacturer's own team or is under the control of the same organization that has jurisdiction over its manufacturing plants at different locations. Quality management of vendor-supplied items/products is carried out as stipulated in the purchasing contract per the quality control specification of the buyer.

Construction projects are constantly increasing in technological complexity. Electromechanical services constitute between 25% and 35% of the total cost of a building project, depending on what type of technologically advance services are required for the project. Figure 4.1 illustrates typical values of various trades of a major building construction project. In this project, the electromechanical work constitutes approximately 36% of the total project value, which shows the increasing technological complexity of building construction projects.

In addition, the requirements of construction clients are on the increase and, as a result, construction products (buildings) must meet varied performance

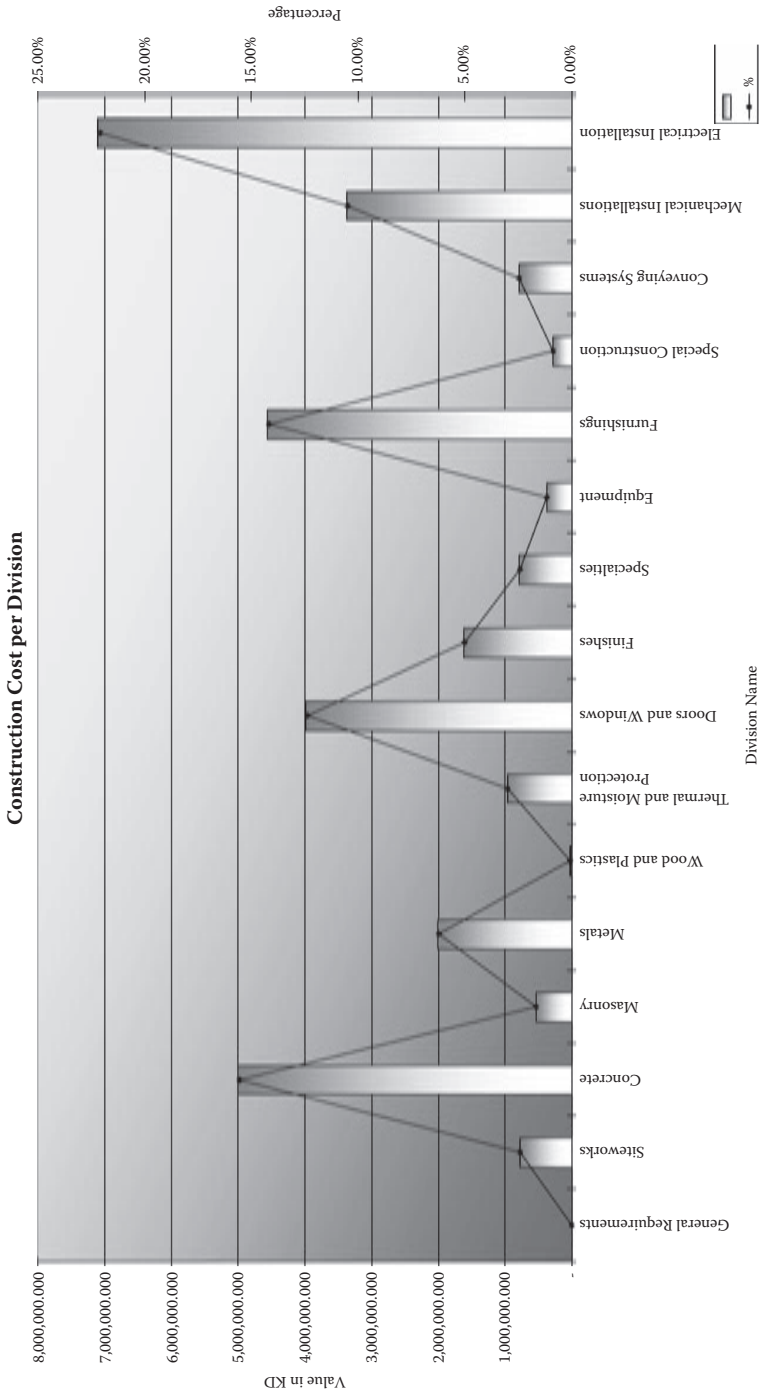

FIGURE 4.1
Division values of a construction project.

standards (climate, rate of deterioration, maintenance, and so on). Therefore, to ensure the adequacy of client brief, which addresses the numerous complex client/user needs, it is now necessary to evaluate the requirements in terms of activities and their interrelationships.

Quality management in construction projects is different from that in manufacturing. Quality in construction projects encompasses not only the quality of products and equipment used in the construction, but the total management approach to completing the facility per the scope of works to customer/owner satisfaction within the budget and in accordance with the specified schedule to meet the owner's defined purpose. The nature of the contracts between the parties plays a dominant part in the quality system required from the project, and the responsibility for fulfilling them must therefore be specified in the project documents. The documents include plans, specifications, schedules, bill of quantities, and so on. Quality control in construction typically involves ensuring compliance with minimum standards of material and workmanship in order to ensure the performance of the facility according to the design. These minimum standards are contained in the specification documents. For the purpose of ensuring compliance, random samples and statistical methods are commonly used as the basis for accepting or rejecting work completed and batches of materials. Rejection of a batch is based on nonconformance or violation of the relevant design specifications.

The survey of Quality of Construction by FIDIC (Federation Internationale des Ingenieurs-Conseils, the international association of consulting engineers) confirmed that failure to achieve appropriate quality of construction is a problem worldwide. Lack of quality in construction is manifested in poor or nonsustainable workmanship, unsafe structure, delays, cost overruns, and disputes in construction contracts.

Defects or failure in construction facilities can result in very large costs. Even with minor defects, reconstruction may be required and facility operation impaired.

Chung (1999) has described the quality of construction as follows:

The quality of building work is difficult, and often impossible, to quantify since a lot of construction practices cannot be assessed in numerical terms. The framework of reference is commonly the appearance of final product. "How good is good enough?" is often a matter of personal judgment and consequently a subject of contention. In fact, a building is of good quality if it will function as intended for its design life. As the true quality of the building will not be revealed until many years after completion, the notion of quality can only be interpreted in terms of the design attributes. So far as the builder is concerned, it is fair to judge the quality of his work by the degree of compliance with the stipulations in the contract, not only the technical specifications but also the contract sum and the contract period. His client cannot but be satisfied if the contract is executed as specified, within budget and on time. Therefore,

a quality product of building construction is one that meets all contractual requirements (including statutory regulations) at optimum cost and time. (p. 4)

About quality in construction CII Source Document 79 (1992) describes that

Quality has many meanings; however, for projects, conformance to established requirements has relevance and clarity. While simple, this definition cannot stand alone. Another term is needed for the term *requirements*. Requirements are contractually established characteristics of a product, process, or service. A characteristic is a physical or chemical property, a dimension, a temperature, a pressure, or any other specification used to define the nature of product, process or service.

The requirements are initially set by client/customer (ordinarily the user/operator of the facility) and are then translated during the pre-planning phase into a conceptual design and estimate developed into a project scope and more fully defined. During the Design phase, the requirements are translated into specific design documents (drawings, plans, specification, purchase orders, and the like). Procurement of fabricated items often proceeds concurrently with design. The products of design and procurement reach the construction site for erection and installation during the construction phase. (p. 5)

An implicit assumption in the traditional quality control practices is the notion of an acceptable quality level, which is an allowable fraction of defective items. Materials obtained from suppliers or work performed percentage should be within the acceptable quality level. Problems with materials or goods are corrected after delivery of the product. In contrast to this traditional approach of quality control is the goal of total quality control. In this system, no defective items are allowed anywhere in the construction process. While the zero defects goal can never be permanently obtained, it provides a goal so that an organization is never satisfied with its quality control program even if defects are reduced by substantial amounts year after year. This concept and approach to quality control was first developed in manufacturing firms in Japan and Europe, but has since spread to many construction companies. Total quality control is a commitment to quality expressed in all parts of an organization and typically involves many elements. Design reviews to ensure safe and effective construction procedures are a major element. Other elements include extensive training for personnel, shifting the responsibility for detecting defects from quality control inspectors to workers, and continually maintaining equipment. Worker involvement in improved quality control is often formalized in quality circles in which groups of workers meet regularly to make suggestions for quality improvement. Material suppliers are also required to ensure zero defects in delivered goods. Initially, all materials from a supplier are inspected and

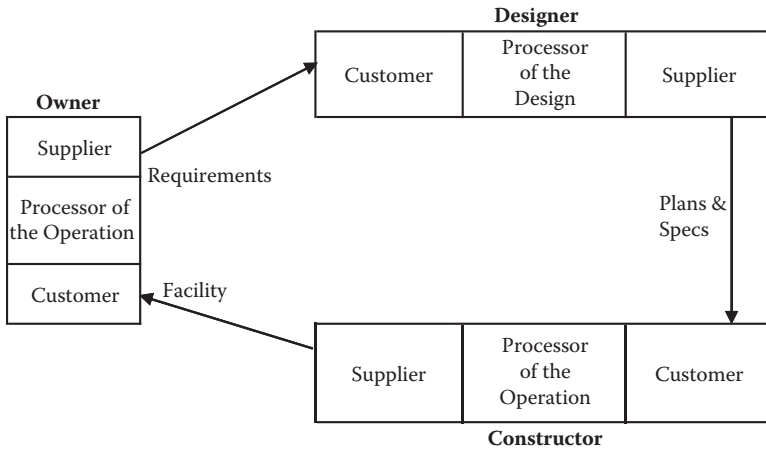

FIGURE 4.2

Triple role concept applied to construction. (From CII Publication 10-3. Reprinted with permission of CII, University of Texas.)

batches of goods with any defective items are returned. Suppliers with good records can be certified, and such suppliers will not be subject to complete inspection subsequently.

Total quality management is an organizationwide effort centered on quality to improve performance that involves everyone and permeates every aspect of an organization to make quality a primary strategic objective. It is a way of managing an organization to ensure the satisfaction at every stage of the needs and expectations of both internal and external customers.

In case of construction projects, an organizational framework is established and implemented mainly by three parties: owner, designer/consultant, and contractor. Project quality is the result of aggressive and systematic application of quality control and quality assurance. Figure 4.2 illustrates Juran's triple concept applied to construction.

Construction projects being unique and nonrepetitive in nature need specified attention to maintain the quality. Each project has to be designed and built to serve a specific need. TQM in construction projects typically involves ensuring compliance with minimum standards of material and workmanship in order to ensure the performance of the facility according to the design. TQM in a construction project is a cooperative form of doing the business that relies on the talents and capabilities of both labor and management to continually improve quality. The important factor in construction projects is to complete the facility per the scope of works to customer/owner satisfaction within the budget and to complete the work within the specified schedule to meet the owner's defined purpose. Figure 4.3 shows various elements influencing the quality of construction.

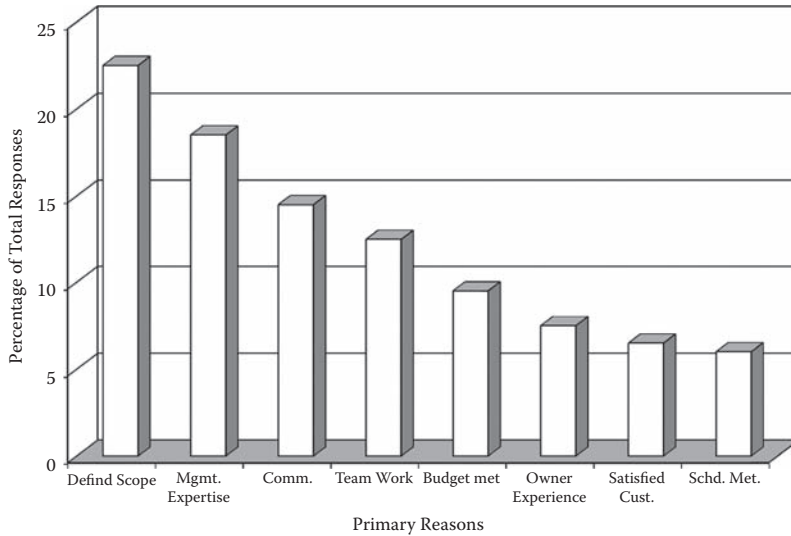

FIGURE 4.3

Primary reasons for quality. (From CII Publication 79. Reprinted with permission of CII, University of Texas.)

Oberlender (2000) has observed:

Quality in construction is achieved by the people who take pride in their work and have the necessary skills and experience to do the work. The actual quality of construction depends largely upon the control of construction itself, which is the principle responsibility of the contractor. ... What is referred to today as "quality control," which is a part of a quality assurance program, is a function that has for years been recognized as the inspection and testing of materials and workmanship to see that the work meets the requirements of the drawings and specifications. (p. 278)

Crosby's quality definition is "conformance to requirements" and that of Oakland is "meeting the requirements." Juran's philosophy of quality is "fitness for use or purpose."

Based on the philosophies of quality gurus, quality of construction projects can be evolved as follows:

1. Properly defined scope of work
2. Owner, project manager, design team leader, consultant, and constructor's manager are responsible to implement quality
3. Continuous improvement can be achieved at different levels as follows:

- a. Owner—Specify the latest needs
 - b. Designer—Specification should include the latest quality materials, products, and equipment
 - c. Constructor—Use the latest construction equipment to build the facility
4. Establishment of performance measures
- a. Owner
 - i. To review and ensure that designer has prepared the contract documents that satisfy his needs
 - ii. To check the progress of work to ensure compliance with the contract documents
 - b. Consultant
 - i. As a consultant designer, to include the owner's requirements explicitly and clearly define them in the contract documents
 - ii. As a supervision consultant, supervise contractor's work per contract documents and the specified standards
 - c. Contractor—To construct the facility as specified and use the materials, products, and equipment that satisfy the specified requirements
5. Team approach—Every member of the project team should know that TQM is a collaborative effort, and everybody should participate in all the functional areas to improve the quality of the project work. They should know that it is a collective effort by all the participants.
6. Training and education—Both consultant and contractor should have customized training plans for their management, engineers, supervisors, office staff, technicians, and laborers.
7. Establish leadership—Organizational leadership should be established to achieve the specified quality. Encourage and help the staff and laborers to understand the quality to be achieved for the project.

These definitions when applied to construction projects relate to the contract specifications or owner/end user requirements to be formulated in such a way that construction of the facility is suitable for the owner's use or meets the owner's requirements. Quality in construction is achieved through the complex interaction of many participants in the facilities development process.

The quality plan for construction projects is part of the overall project documentation consisting of the following:

1. Well-defined specification for all the materials, products, components, and equipment to be used to construct the facility
2. Detailed construction drawings

3. Detailed work procedure
4. Details of the quality standards and codes to be compiled
5. Cost of the project
6. Manpower and other resources to be used for the project
7. Project completion schedule

Figure 4.4 illustrates functional relationships between various participants.

Table 4.1 identifies the key quality assurance activities that would take place during the life cycle of a typical construction project. These activities are performed by all the participants of the construction projects at various phases/stages of the project.

Ishikawa (1985) has set forth ten principles to improve quality assurance and to eliminate unsatisfactory relations between the purchaser (vendee) and the supplier (vendor). Table 4.2 summarizes the quality control principles and their application in construction projects.

In order to process the construction project in an effective and efficient manner and to improve control and planning, construction projects are divided into various phases. In traditional thinking, there are five phases

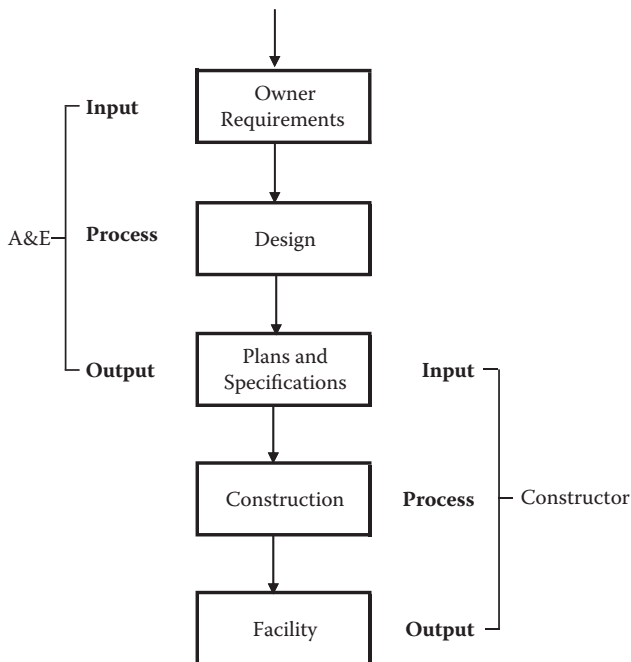

FIGURE 4.4

Juran's triple role-functional relationship. (From CII Publication 51. Reprinted with permission of CII, University of Texas.)

TABLE 4.1

Key Quality Assurance Activities on a Typical Construction Project

This flowchart identifies the key quality assurance activities during the life cycle of a typical construction project, from project initiation to handover.

Client	Design Consultant	Contractor
Establish project brief/ objectives/ specification (include QA conditions)	Carry out tender review, prepare outline PQP, and submit	
Accept outline PQP		
Place contract	Set up project team, carry out contract review, prepare PQP	
Approve PQP	Submit for approval	
Approve DQP	Prepare DQP, if appropriate	
Approve key drawings	Prepare drawings	
Approve calculations	Prepare calculations, carry out design reviews, prepare detailed specifications	
Monitor design consultant's activities by audit	Issue enquires for construction work, including QA conditions	Carry out tender review, prepare QA submission
	Carry out bid appraisal assess QA submission	
	Place contract with QA conditions	Carry out contract review setup site team
	Approve PQP	Prepare PQP and submit for approval
	Approve shop drawings and other documents	Place subcontracts, including QA condition when appropriate to work package. Include requirement for documentation submissions, approvals, and records
		Receive DQPs from subcontractors for approval before commencement of work
	Approve DQPs	Prepare DQPs for own work if required
	Project management contract. Conduct progress meeting. Monitor work by inspection test and review of documentation	Place "hold points," etc., on DQPs to monitor work packages. Approve DQPs
		Monitor off-site work against DQPs

(Continued)

TABLE 4.1 (Continued)

Key Quality Assurance Activities on a Typical Construction Project

Client	Design Consultant	Contractor
	Carry out audits per agreed-upon schedules	Carry out goods inwards inspection per agreed procedure Control work on site against PQP, DQPs, inspection checklist, etc. Carry out audits on- and off-site per agreed audit schedule Generate records as construction proceeds Mark up drawing to as-built state Prepare handover packages and submit
Accept documentation package	Check handover package and submit with design records	

Source: Thorpe, B., Sumner, P., and Duncan, J. (1996). *Quality Assurance in Construction*. Reprinted with permission from Ashgate Publishing Limited.

Note: This table identifies the key quality assurance activities during the life cycle of a typical construction project, from project initiation to handover.

of a construction project life cycle, which are further broken into various activities. These are Conceptual Design, Preliminary Design, Detail Engineering, Construction, and Commissioning and Handing Over.

Participation of all three parties at different levels during construction is required to develop a quality system and apply quality tools and techniques. With the application of various quality principles, tools, and methods by all the participants at different stages of construction, rework can be reduced, resulting in savings in the project cost and making the project qualitative and economical. This will ensure completion of a construction project and make the project qualitative, competitive, and economical in a way that will meet the owner's needs and specification requirements.

There are several types of contracting system that these parties are involved in at different levels contracts. The following are the types of contracting systems that are normally used in building and civil engineering construction:

1. Design/Bid/Build type Contracting System (Traditional Contracting System)
2. Design/Build type Contracting System
3. Project Manager type Contracting System

TABLE 4.2**Ten Quality Control Principles to Improve Vendee–Vendor Relations**

Principle	Ishikawa Principle	Application in Construction Projects
Principle 1	Both vendee and vendor are fully responsible for the quality control application and harmonizing their quality control systems	The owner, consultant, and contractor are fully responsible for application of quality control to meet the defined scope of work in the contract documents
Principle 2	Both vendee and vendor should be independent of each other and respect the independence of the other party	The contractor shall follow an agreed-upon quality control plan, and the consultant shall be responsible for overseeing compliance with contract documents
Principle 3	The vendee is responsible for supplying clear and adequate information and requirements to the vendor so that the vendor can know precisely how and what should be manufactured	The consultant is responsible for providing the owner's requirements explicitly and clearly defining them in the contract documents
Principle 4	Both vendee and vendor, before entering into business transactions, should conclude a rational contract between them in respect to quality, quantity, price, delivery systems, and method of payment	The contractor should study all the documents during the tendering/bidding stage and submit his proposal taking into consideration all the requirements specified in the contract documents
Principle 5	The vendor is responsible for the assurance of quality that will give satisfaction to the vendee, and he is also responsible for submitting necessary and actual data upon the vendee's request	The contractor is responsible for constructing the facility as specified and using materials, products, equipment, and methods that satisfy the specified requirements. The contractor shall follow the submittal procedure specified in the contract documents
Principle 6	Both vendee and vendor should decide the evaluation method of various items beforehand, which will be accepted as satisfactory to both parties	Method of payment (work progress, material, equipment, etc.) to be clearly defined in the contract documents. Rate analysis of BOQ or BOM item to be agreed upon before signing of the contract
Principle 7	Both vendee and vendor should establish in their contract the systems and procedures through which they can amicably settle disputes whenever any problems occur	Contract documents should include a clause to settle disputes arising during the construction stage itself

(Continued)

TABLE 4.2 (Continued)

Ten Quality Control Principles to Improve Vendee–Vendor Relations

Principle	Ishikawa Principle	Application in Construction Projects
Principle 8	Both vendee and vendor, taking into consideration the other party's standing, should exchange the information necessary to carry out better quality control	Each member of the project team should participate in all the functional areas to improve the quality of the project
Principle 9	Both vendee and vendor should always perform control business activities sufficiently, such as ordering, production and inventory planning, clerical work, and systems, so that their relationship is maintained and remains amicable and satisfactory	The contractor should perform the work per the agreed-upon construction program and hand over the project per the contracted schedule. The contractor is responsible for providing all the resources, manpower, material, equipment, etc., to build the facility per specifications
Principle 10	Both vendee and vendor, when dealing with business transactions, should always take full account of the consumer's interests	The contractor should build the facility as stipulated in the contract documents, plan, and specifications within budget and on schedule to meet the owner's objectives

Source: Ishikawa, K. (1985). *What Is Total Quality Control? The Japanese Way*. David J. Lu, tr. Reprinted with permission from Pearson Education, Inc.

4. Construction Manager type Contracting System
5. Guaranteed Maximum Price
6. Build–Own–Operate–Transfer
7. Turnkey Contract

4.1.1 Design/Bid/Build

In this method, the owner contracts design professionals to prepare detailed design and contract documents. These are used to receive competitive bids from the contractors. A design/bid/build contract has a well-defined scope of work. This method involves three steps:

1. Preparation of complete detailed design and contract documents for tendering
2. Receiving bids from prequalified contractors
3. Award of contract to successful bidder

In this method, two separate contracts are awarded, one to the designer/consultant and one to the contractor. In this type of contract structure, design responsibility is primarily that of the architect or engineer employed by the

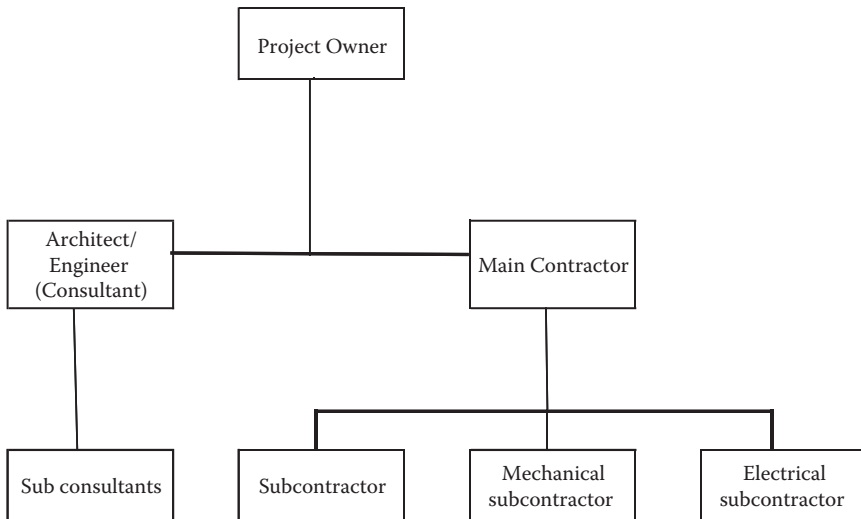

FIGURE 4.5
Design/bid/build type contracting system.

client and the contractor is primarily responsible for construction only. In most cases, the owner contracts the designer/consultant to supervise the construction process. These types of contracts are lump-sum, fixed-priced contracts. Any variation, or change, during the construction needs prior approval from the owner. Since a complete design is prepared before construction, the owner knows the cost of the project, time of completion of the project, and the configuration of the project. The client, through the architect or engineer, retains control of design during construction. This type of contracting system requires considerable time; each step must be completed before starting the next step. Figure 4.5 illustrates the design/bid/build type of contract relationship.

4.1.2 Design/Build

In a design/build contract, the owner contracts a single firm to design and build the project. In this type of contracting system, the contractor is appointed based on an outline design or design brief to understand the project owner's intent. The owner has to clearly define his or her needs and scope of work before the signing of the contract. It is imperative that the project definition be understood by the contractor to avoid any conflict, as the contractor is responsible for detailed design and construction of the project. A design/build type of contract is often used to shorten the time required to complete a project. Since the contract with the design/build firm is awarded before starting any design or construction, a cost plus contract or reimbursable arrangement is normally used instead of lump-sum, fixed-cost arrangement. This type of contract requires extensive

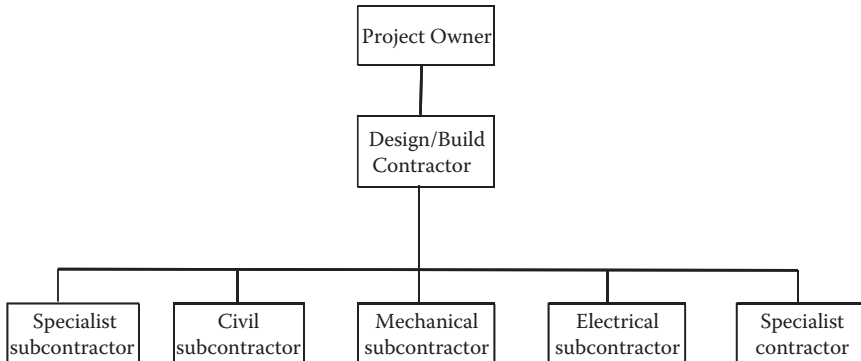

FIGURE 4.6
Design/build type contracting system.

involvement on the part of the owner during the entire life cycle of the project. He or she has to be involved in making decisions during the selection of design alternatives and the monitoring of costs, schedules, and quality during construction and, therefore, the owner has to maintain/hire a team of qualified professionals to perform these activities. Design/build contracts are used for relatively straightforward work, where no significant risk or change is anticipated and when the owner is able to specify precisely what is required. Figure 4.6 illustrates the design/build type of contract relationship.

4.1.3 Project Manager

A project manager contract is used when the owner decides to turn over the entire project management to a professional project manager. In the project manager type of contract, the project manager is the owner's representative and is directly responsible to the owner. The project manager is responsible for planning, monitoring, and managing the project. In its broadest sense, the project manager has responsibility for all the phases of the project from inception of the project until the completion and handing over of the project to the owner/end user. The project manager is involved in giving advice to the owner and is responsible for the appointment of design professionals, consultants, supervision firm, and selection of the contractor who will implement the project. Figure 4.7 illustrates the project manager type of contract relationship.

4.1.4 Construction Manager

In this method, the owner contracts a construction management firm to coordinate the project and to provide construction management services. The construction management type of contract system is a four-party arrangement involving the owner, designer, construction management firm, and contractor.

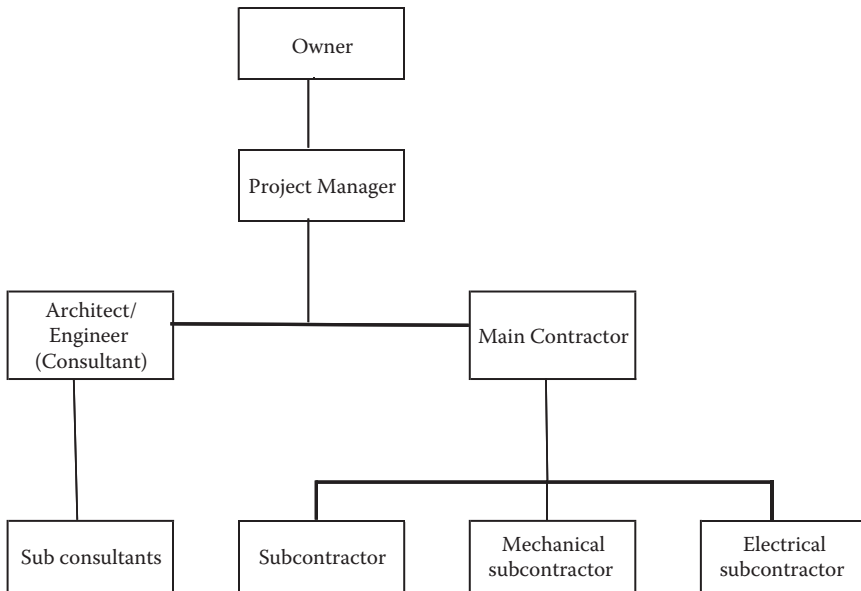

FIGURE 4.7
Project manager type contracting system.

The construction manager provides advice to the owner regarding cost, time, safety, and about the quality of materials/products/systems to be used on the project. The architect/engineer or supervisor is responsible for maintaining the construction quality and supervising the construction process. The basic prerequisite for the construction manager type of contract is that the firm be knowledgeable and capable of coordinating all aspects of the project to meet the intended use of the project by the owner. There are two general types of construction manager type of contracts. These are

1. Agency construction manager
2. At-risk construction manager

The agency construction manager acts as an advisor to the owner/client, whereas the at-risk construction manager is responsible for on-site performance and actually performs some of the project work. The agency construction manager firm performs no design or construction, but assists the owner in selecting design firms and contractors to implement the project. Figure 4.8 illustrates the agency construction manager type of relationship.

4.1.5 Guaranteed Maximum Price

In this method, the contractor is compensated for the actual costs incurred in connection with design and construction of the project, plus a fixed

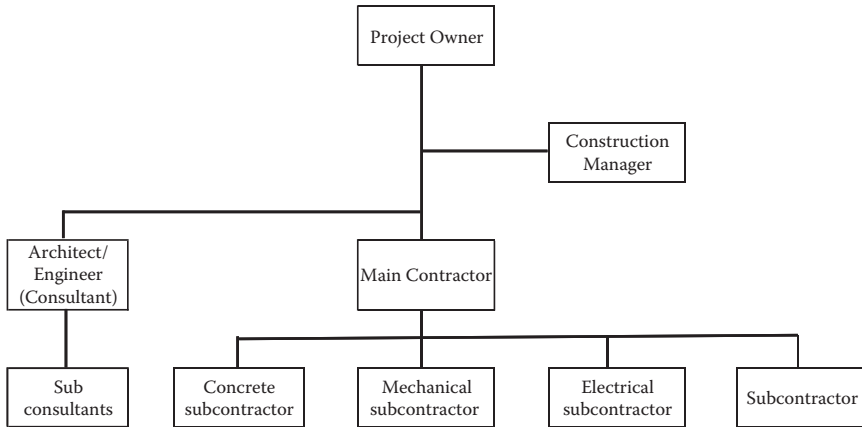

FIGURE 4.8
Construction manager type contracting system.

fee—all subject, however, to a ceiling above which the client is not obligated to pay. A guaranteed maximum price contract specifies a target profit (or fees), a price ceiling (but not for a profit ceiling or floor) and a profit (or fee) adjustment formula. These elements are all negotiated at the outset. The guaranteed maximum price contract combines construction management with design/build. With a guaranteed maximum price contract, amounts below the maximum are typically shared between the client and the contractor, while the contractor is responsible for absorbing the cost above the maximum. Any changes due to specific instructions issued by the owner fall outside the scope of the guaranteed price. A cost plus guaranteed maximum price, as it is also known, type of contract is typically used

- When time pressure requires letting of the contract before design development is sufficiently advanced to allow a conventional lump-sum type of contract to be fixed
- If this type of contract is likely to be less costly than other types
- When financing or other constraints preclude the use of alternatives such as two-stage contract of construction management
- If it is impractical to obtain certain types of services with improved delivery or technical performance, or quality without the use of this type of contract

In this method, the contractor and owner know that the drawings and specifications are not complete, and the contractor and owner agree to work together to complete the drawings and specifications as provided in the contract agreement. This type of contract is weighted heavily in favor of the

owner. The contractor takes on all the risk in this type of contracting system. Value engineering studies are conducted to identify design alternatives to help the project contractor maintain the budget and schedule. This type of contract needs

- The contractor's tendering/bidding department should have adequate information to provide the necessary data to support negotiation of final cost and incentive price revision
- Adequate cost pricing information for establishing a reasonable firm target price at the time of initial contract negotiation
- High administration cost from the owner side to monitor what the contractor is actually spending to get the benefit of underspending
- Evaluation of a minimum of two or three proposals for any major subcontract work

In certain GMP contracts, the owner monitors and controls the contractor's expenses toward the project resources such as construction equipment, machinery, manpower, and staff on a monthly basis by fixing the basic price and profit percentage agreed upon at the initial stage.

4.1.6 Build–Own–Operate–Transfer

This type of method is generally used by governments to develop public infrastructure by involving the private sector in financing, designing, operating, and managing the facility for a specified period and then transferring the facility to the same government free of charge. The terms BOOT and BOT are used synonymously.

Examples of BOT projects include

- Airports
- Bridges
- Motorways/toll roads
- Parking facilities
- Tunnels

Certain countries allow the private sector to develop commercial and recreational facilities on government land through the BOT scheme.

4.1.7 The Turnkey Contract

As the name suggests, these are the types of contracts where, upon completion, one turns a key in the door and finds everything working to full operating standards. In this type of method, the owner employs a single firm to undertake design, procurement, construction, and commissioning of the entire work. The firm is also involved in management of the project during

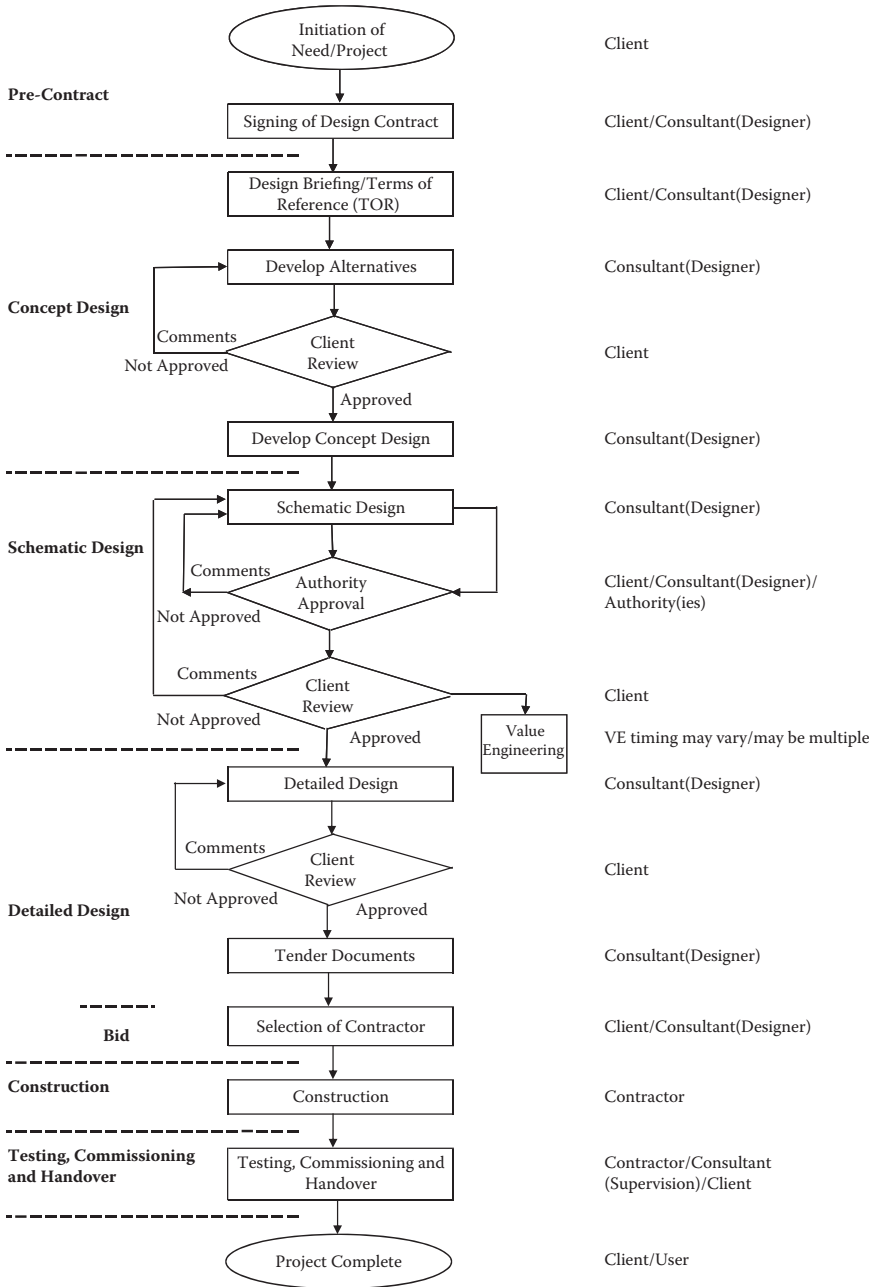

FIGURE 4.9 Logic flow diagram for construction projects: design/bid/build.

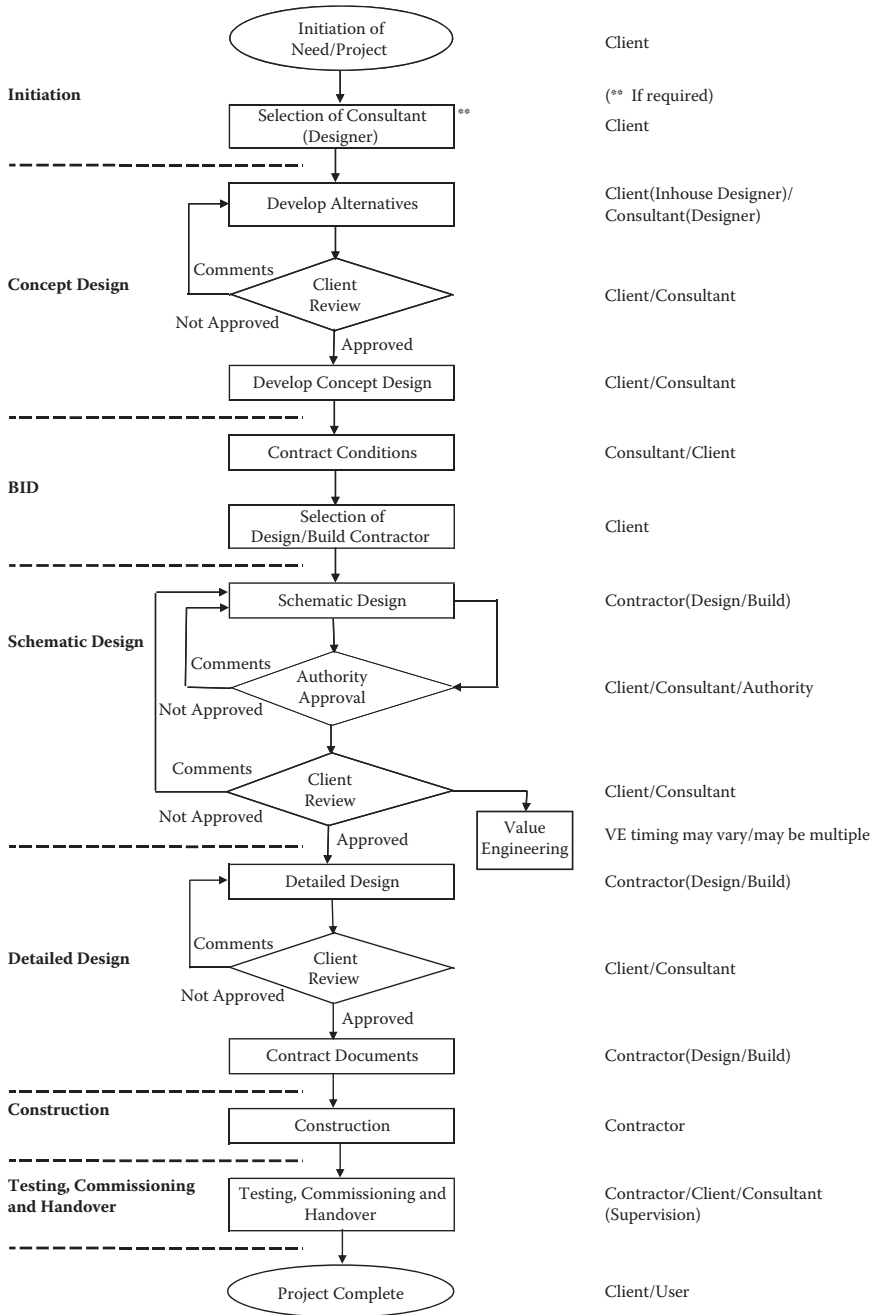

FIGURE 4.10
Logic flow diagram for construction projects: design/build.

the entire process of the contract. The client is responsible for preparation of their statement of requirements, which becomes the strict responsibility of the contractor to deliver. This type of contract is used mainly for the process type of project and is sometimes called engineering, procurement, and construction (EPC).

There are two general types of owners: single-builder owners and multiple-builder owners. Single-builder owners are organizations that do not have a need for projects on a repetitive basis, normally have a limited project staff, and contract all design and construction activities to outside organizations. They usually handle projects with a design/bid/build or construction management contract. Multiple-builder owners are generally large organizations that have a continual need for projects and generally have a staff assigned to project work. They typically handle small-sized, short-duration projects by design/bid/build. For a project in which they desire extensive involvement, a design/build, construction management, or an owner/agent contract arrangement is often used.

All the foregoing contract deliverable systems follow generic life cycle phases of a construction project; however, the involvement/participation of various parties differs depending on the type of deliverable system adapted for a particular project.

In case of the design/build type of deliverable system, the contractor is contracted right from the early stage of the construction project and is responsible for design development of the project. Figure 4.9 shows the typical logic flow diagram for the design/bid/build type of construction project, and Figure 4.10 shows the diagram for the design/build type of contracting system. Details of activities performed during the various phases of the design/bid/build type of contract delivery system are discussed in related sections.

4.2 Conceptual Design

Conceptual design is the first phase of the construction project life cycle. The conceptual design is initiated once the need is recognized. In this phase, the idea is conceived and given an initial assessment. Conceptual design, or the design development phase, is often viewed as most critical to achieving outstanding project performance. During the conceptual phase, the environment is examined, forecasts are prepared, objectives and alternatives are evaluated, and the first examination of the technical performance, cost, and time objectives of the project is made. The conceptual phase includes

- Identification of need by the owner, and establishment of main goals
- Feasibility study, which is based on owner's objectives

- Identification of project team by selecting other members and allocation of responsibilities
- Identification of alternatives
- Financial implications, resources, based on estimation of life cycle cost of the favorable alternative
- Time schedule
- Development of concept design

The most significant impacts on the quality in a project occur during the conceptual phase. This is the time when specifications, statement of work, contractual agreements, and initial design are developed. Initial planning has the greatest impact on a project because it requires the commitment of processes, resources schedules, and budgets. A small error that is allowed to stay in the plan is magnified several times through subsequent documents that are second or third in the hierarchy.

Figure 4.11 shows major activities in the conceptual design phase.

4.2.1 Identification of Need

Most construction projects begin with recognition of the new facility. The owner of the facility could be an individual, a public/private sector company, or a governmental agency. The need for the project is created by the owner and is linked to the financial resources available to develop the facility. The owner's needs are quite simple and are based on the following:

- To have best use of the money, that is, to have maximum profit or services at a reasonable cost
- On time completion, that is, to meet the owner's/user's schedule
- Completion within budget, that is, to meet the investment plan for the facility

The conceptual design is initiated once the owner's need is recognized. Therefore, it is important that the owner define the requirements and objectives of the potential project clearly at the start of the formulation of design. The need statement is an expression of an unfulfilled requirement. It provides a specifically focused requirement that can be addressed as a way of providing a solution.

The owner's need must be well defined, indicating the minimum requirements of quality and performance, an approved main budget, and required completion date. Sometimes, the project budget is fixed and, therefore, the quality of the building system, materials, and completion of the project needs to be balanced with the budget.

Figure 4.12 illustrates a preliminary appraisal and the steps in the project identification.

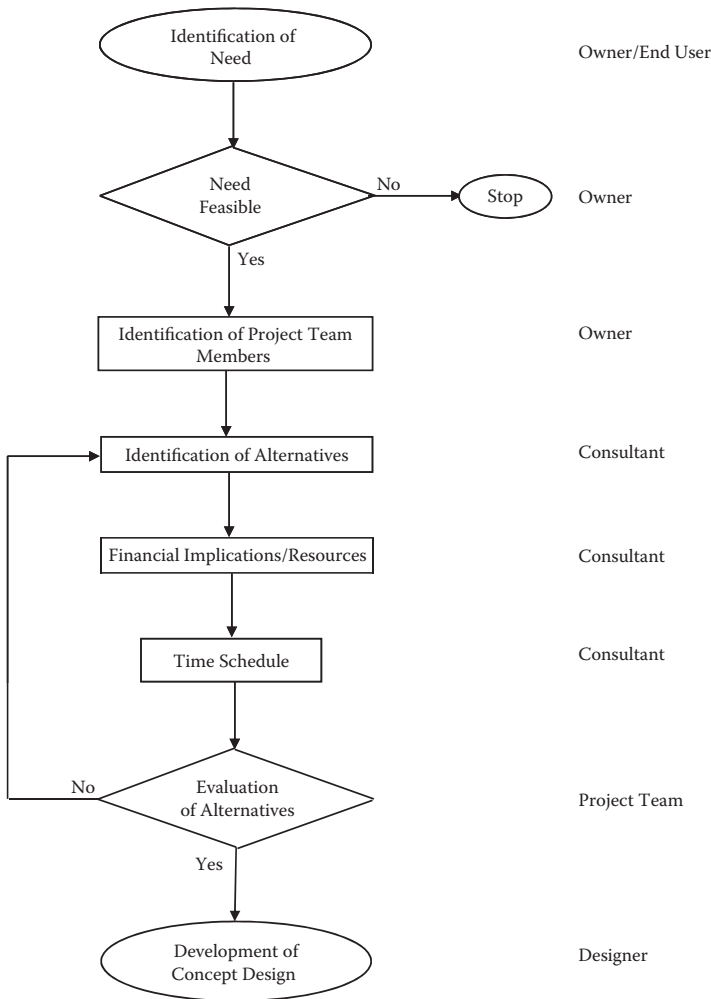

FIGURE 4.11
Major activities in the conceptual design phase.

4.2.2 Feasibility

Once the owner's need is identified, the traditional approach is pursued through a feasibility study or an economical appraisal of owner needs or benefits, also taking into account the many relevant moral, social, environmental, and technical constraints. The feasibility study takes its starting point from the output of the project identification need.

The authors of *Civil Engineering Procedure* (Institution of Civil Engineers, 1996) have listed some of the investigations to be carried out for a major project. These are as follows:

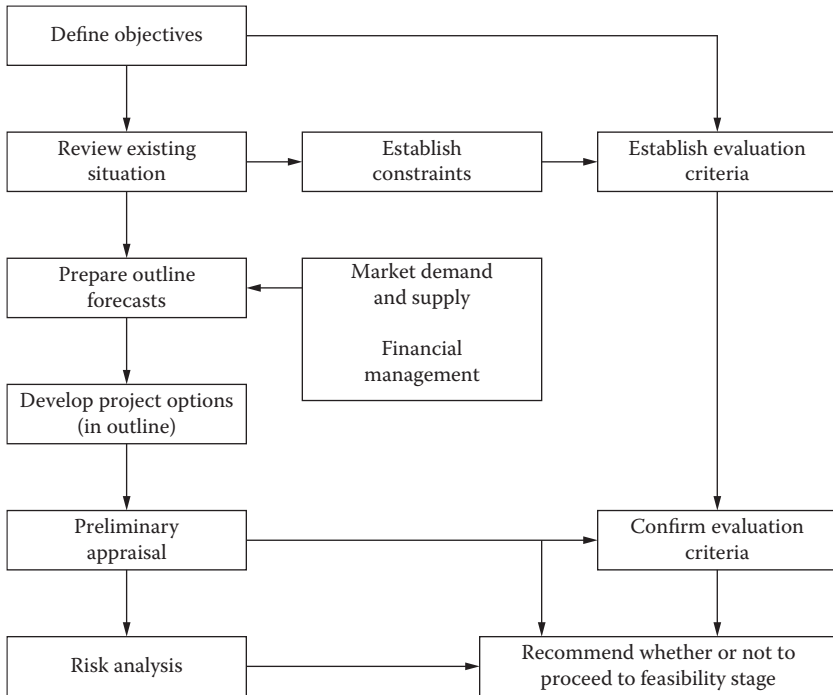

FIGURE 4.12

Steps in project identification. (From R.K. Corrie, *Engineering Management Project Evaluation*, 1991. Reprinted with permission from Thomas Telford Publishing, UK.)

- Outline design
- Studies of novel requirements and risks
- Public consultation
- Geotechnical study of site, sources of materials, storage areas, and access routes
- Environmental impact analysis
- Health and safety studies
- Testing for contaminated land and requirements for the disposal of waste
- Estimates of capital and operating costs
- A master program of work, expenditure, and financing
- Assessment of funding (p. 22)

Depending on the circumstances, the feasibility study may be short or lengthy, simple or complex. In any case, it is the principle requirement in

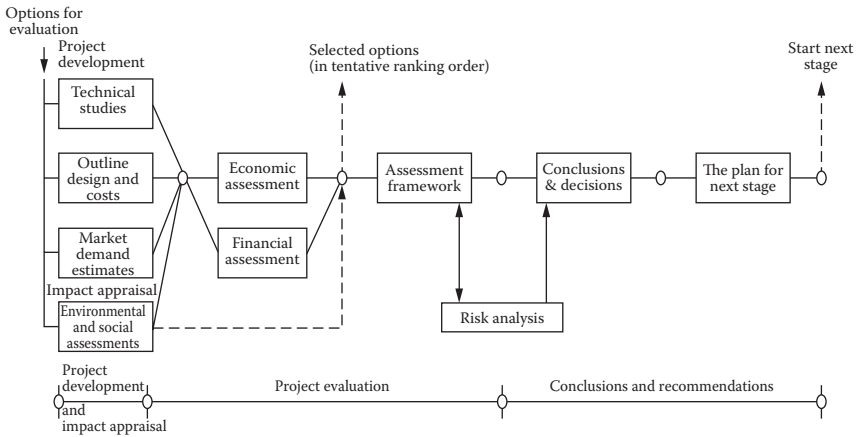

FIGURE 4.13

Project feasibility stages. (From R.K. Corrie, *Engineering Management Project Evaluation*, 1991. Reprinted with permission from Thomas Telford Publishing, UK.)

project development as it gives the owner an early assessment of the viability of the project and the degree of risk involved. The outcome of the feasibility study helps select a defined project that meets the stated project objectives, together with a broad plan of implementation. Figure 4.13 illustrates various stages for a feasibility study.

Technical studies are performed to analyze that the proposed facility is suitable for intended use by the owner/user. The proposed project is economically feasible if the total value of the benefits that result from the project exceed the cost that results from the project. Economic feasibility depends on technical feasibility because the facility must be suitable for intended use. Financial feasibility may or may not be related to economic feasibility.

The project study is usually performed by the owner through his own team or by engaging individuals/organizations involved in preparation of economic and financial studies. Once the project definition has been ascertained, the owner selects other team members of the project and finalizes the contract delivery system for the project. If the feasibility study shows that the objectives of the owner are best met through the ideas generated, then the owner will select and engage a project team based on the project delivery system to develop his notional ideas into a more workable form.

4.2.3 Identification of Project Team

Most construction projects involve three major groups or parties:

1. **Owner:** A person or an organization that articulated the need for the facility and responsible for arranging the financial resources for the creation of the facility.

2. Designer/consultant: This consists of architects, engineers, or consultants. They are the owner's appointed entity accountable for converting the owner's conception and need into a specific facility with detailed directions through drawings and specifications, within the economic objectives and schedule. They are responsible for the design process and assist the owner in preparation of tender and contract documents. The owner may engage the designer to supervise construction.
3. Contractor: A construction firm engaged by the owner to complete the specified facility by providing the necessary staff, workforce, materials, equipment, tools, and other accessories to complete the project to the satisfaction of the owner/end user in compliance with the contract documents.

The owner is the first member of the project team. The owner's relationship with other team members and his or her responsibilities depend on the type of deliverable system the owner would prefer to go with. There are many types of contract delivery systems; however, design/bid/build is the most predominantly used contracting system preferred by the owners.

For the design/bid/build type of contract system, the first thing the owner has to do is select design professionals/consultants. Generally, the owner selects a designer/consultant with whom he or she has worked before with satisfactory results. The owner can use his or her preferred designer/consultant or select one by obtaining proposals from several design professionals/consultants. The owner may contract a designer or A&E to provide site supervision during the construction process. Thus, the designer or A&E firm acts as the prime professional to design the project and also supervises the construction.

Once the project delivery system is finalized and the designer/consultant is selected and contracted by the owner to proceed with the project design, a Terms of Reference (TOR) is issued to the designer/consultant to prepare a design proposal and contract documents. A TOR is a document that describes the purpose and structure of a project. It gives the project team a clear understanding of the development of the project.

Table 4.3 illustrates the typical requirements of project team members. Table 4.4 illustrates the typical responsibilities of project team members. Figure 4.14 illustrates the responsibilities of different parties.

The TOR generally requires the designer (consultant) to perform the following:

- Predevelopment studies, which includes data collection and analysis related to the project
- Development of conceptual alternatives
- Evaluation of conceptual alternatives and selection of preferred alternatives in consultation with the owner

TABLE 4.3

Typical Requirements of Project Team Members

Owner/Project Manager	Design Professional or A&E	Constructor
Adequate function and appearance of the new facility	An adequate project scope definition An adequate budget	A well-defined set of contract documents
Project completion on time and within budget	A reasonable schedule Timely decisions from the owner	Timely decisions from the owner and design professional
Desirable balance of life cycle and initial capital costs	Realistic and fair sharing of project risks	Realistic and fair sharing of project risks
Addressing of environmental, health, permitting, safety, user impacts, and sustainable development considerations	Adequate communication with the owner regarding performance A fair and reasonable process for resolving disputes	Adequate communication with the owner regarding performance A fair and reasonable process for resolving disputes
A fair and reasonable process for resolving disputes	Timely payment and a reasonable profit	Timely payment and a reasonable profit

Source: American Society of Civil Engineers, *Quality in the Constructed Project*, 2000. Reprinted with permission from ASCE.

- Preparation of preliminary design, budget, and schedule and obtaining authorities' approvals
- Preparation of detailed design and contract documents for tendering purpose

Table 4.5 illustrates the contribution of various participants during all the phases of the construction project life cycle for the design/bid/build type of contracting system.

4.2.4 Identification of Alternatives

Table 4.6 shows a quantitative comparison of functional alternatives to cost alternatives that may be analyzed to select the preferred alternative.

Each alternative is based on a predetermined set of performance measures to meet the owner's requirements. In case of construction projects, it is mainly the extensive review of development options that are discussed between the owner and the designer/consultant. The consultant engineer provides engineering advice to the owner to enable him to assess its feasibility and the relative merits of various alternative schemes to meet his requirements. Social, economical, and environmental impacts, functional capability, safety, and reliability should be taken into account while considering the development of alternatives. Each alternative is evaluated

TABLE 4.4

Typical Responsibilities of Project Team Members

Owner/Project Manager	Design Professional or A&E	Constructor
Fulfillment of contractual obligations to other team members, including furnishing site and related information, and timely payment	Fulfillment of contractual obligations to other team members	Fulfillment of contractual obligations to other team members
Compliance with applicable laws, regulations, codes, standards, and practices	Compliance with applicable laws, regulations, codes, standards, and practices	Compliance with applicable laws, regulations, codes, standards, and practices
Provision of adequate funding	Fulfillment of professional standards	Interpretation of plans and specifications
Provision of necessary real estate or rights of way	Development and drafting of well-defined contract documents	Construction of facility as described in contract documents
Provision of project goals and objectives	Responsiveness to project schedule, budget, and program	Management of construction site activities and safety program
Fulfillment of insurance and legal requirements	Provision of construction-phase design services	Management, quality control, and payment of subcontractors and vendors
Assignment of site safety responsibility		
Acceptance of completed facility		

Source: American Society of Civil Engineers, *Quality in the Constructed Project* (2000) by ASCE. Reprinted with permission from ASCE.

based on the predetermined set of performance measures to meet the owner's requirements. Figure 4.15 summarizes the general steps in the systematic process of studying project alternatives and evaluating associated impacts.

Quantitative comparison and evaluation of conceptual alternatives are carried out by considering the advantages and disadvantages of each item systematically. The designer makes a brief presentation to the owner, and the project is selected based on preferred conceptual alternatives. Various possibilities are considered during this stage, and the technological and economical feasibility is assessed and compared to select the best possible alternative.

4.2.5 Financial Implications/Resources

The next step is to refine cost estimates for the conceptual alternatives as this is required by the owner to determine the capital cost of construction, so that

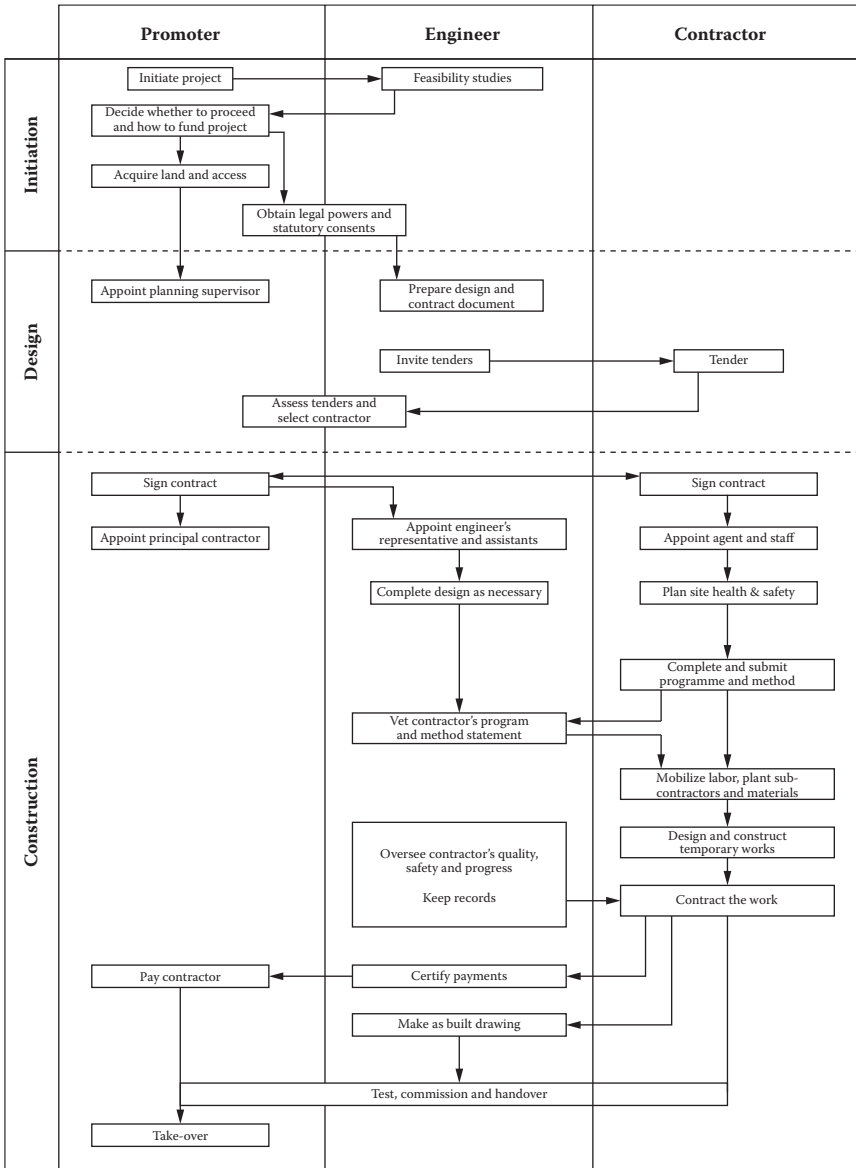

FIGURE 4.14

Division of responsibility. (From *Civil Engineering Procedure* by ICE. Reprinted with permission from Thomas Telford Publishing, UK.)

TABLE 4.5

Contribution of Various Participants (Design/Bid/Build Type of Contracts)

Phase	Example of Contribution		
	Owner	Designer	Contractor
Conceptual design	Identification of need Selection of alternative Selection of team members Approval of time schedule Approval of budget TOR	Feasibility Development of alternatives Cost estimates Schedule Development of concept design	
Preliminary design	Approval of preliminary (schematic) design	Develop general layout/scope of facility/project Regulatory approval Budget Schedule Contract terms and conditions	
Detailed design	Approval of budget Approval of time schedule Approval of design Contract negotiation Signing of contract	Development of detail design Authorities' approval Detail plan Budget Schedule BOQ Tender documents Evaluation of bids	Collection of tender documents Preparation of proposal Submission of bid
Construction	Approve subcontractors Approve contractor's core staff Legal/regulatory clearance Site works instruction Variation order Payments	Supervision Approve plan Monitor work progress Approve shop drawings Approve material Recommend payment	Execution of work Contract management Selection of subcontractors Selection of core staff Planning Resources Procurement Quality Safety
Testing, commissioning, and handover	Training Acceptance of project Substantial completion certificate Payments	Witness tests Check closeout requirements Recommend takeover Recommend issuance of substantial completion certificate	Testing Commissioning Authorities' approvals Documents Training Handover

TABLE 4.6

Conceptual Alternatives

Functional Alternatives	Cost Alternatives
<ul style="list-style-type: none"> • Materials-handling methods • Traffic flow arrangements (patterns in air, water, land, people, or products) • Types of travel modes (vehicle type, size, style) • Method to provide fish passage at barriers in waterways • Space allocations • Clear-span requirements in buildings • Public/private (joint development) options • Methods to avoid or minimize impacts to the natural environment 	<ul style="list-style-type: none"> • Design cost • Capital cost of construction • Operation and maintenance costs • Life expectancy or design-life periods • Return on investment • Project phasing (initial opening or operating segments) • Extra cost for aesthetics • Cost/benefit ratios

Source: American Society of Civil Engineers, *Quality in the Constructed Project*, 2000. Reprinted with permission from ASCE.

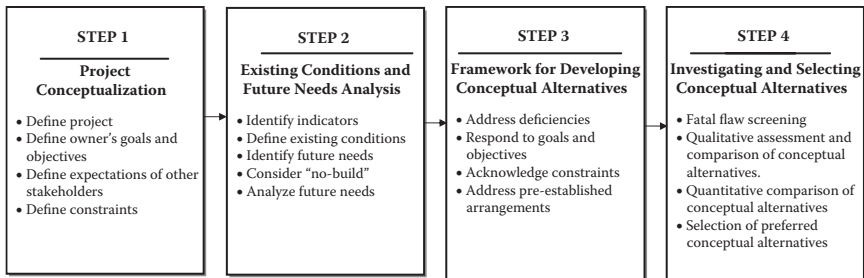

FIGURE 4.15

Alternative study and impact analysis process. (From American Society of Civil Engineers, *Quality in the Constructed Project*, 2000. Reprinted with permission from ASCE.)

he or she can arrange the finances. It is the owner's responsibility to provide an approved maximum finance to complete the facility. It is required that the owner formulate his or her thoughts on project financing, as the financial conditions will affect the possible options from the beginning. Normally the following points should be considered:

1. What are sources of funding?
2. What criteria or rules apply?
3. How could the project best respond to those rules?

In case any funding agency is involved in financing the project, it may impose certain conditions that affect the project feasibility and implementation. It is likely that such funding agencies may also insist on the adoption of a particular contract strategy.

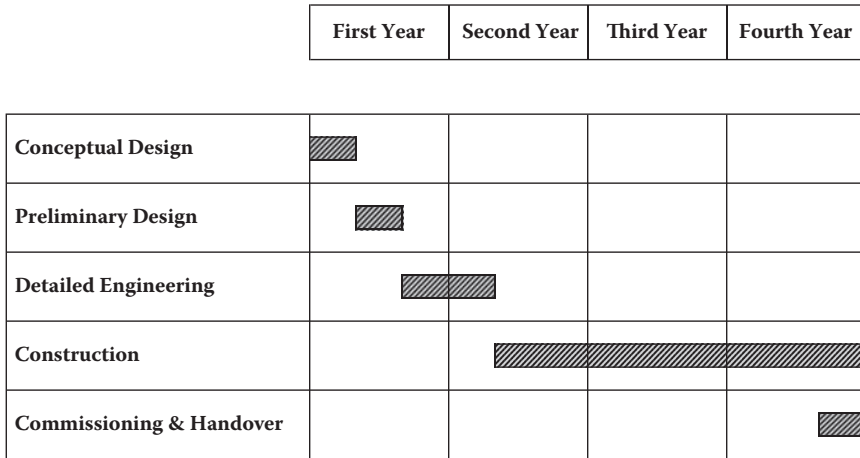

FIGURE 4.16
Typical time schedule.

4.2.6 Time Schedule

The duration of a construction project is finite and has a definite beginning and a definite end, therefore during the conceptual phase the expected time schedule for the completion of the project/facility is worked out. The expected time schedule is important from both financial and acquisition of the facility by the owner/end user. It is the owner’s goal and objective that the facility is completed in time. Figure 4.16 illustrates a time schedule for a typical construction project.

4.2.7 Development of Concept Design

The selected preferred alternative is the base for development of the concept design. The designer can use techniques such as quality function deployment (QFD) to translate the owner’s need into technical specifications. Figure 4.17 illustrates the house of quality concept for an office building project based on certain specific requirements by the customer.

While developing the concept design, the designer must consider the following:

1. Project goals
2. Usage
3. Technical and functional capability
4. Aesthetics
5. Constructability
6. Sustainability (environmental, social, and economical)
7. Health and safety

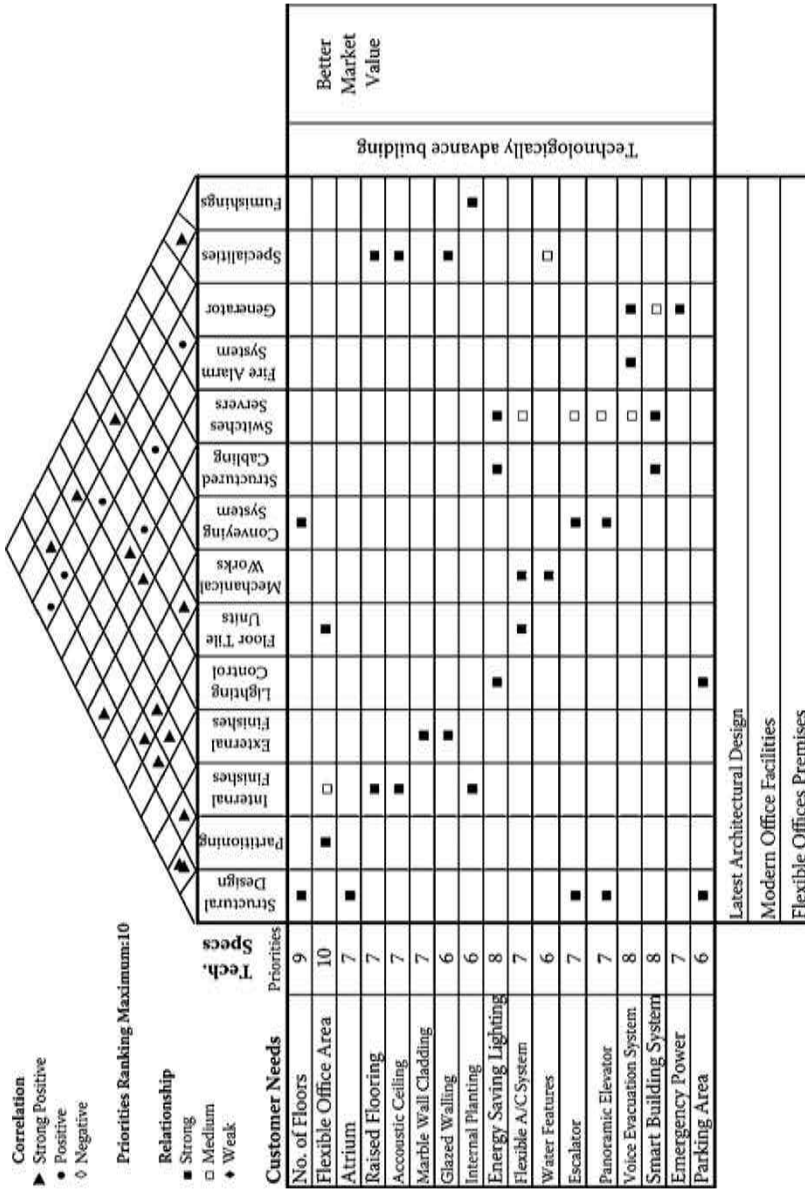

FIGURE 4.17 House of quality for office building project.

8. Reliability
9. Environmental compatibility
10. Fire protection measures
11. Supportability during maintenance/maintainability
12. Cost-effectiveness over the entire life cycle (economy)

It is the designer's responsibility to pay greater attention to improving the environment and to achieve sustainable development. Numerous UN meetings (such as the first United Nations conference on Human Development held in Stockholm in 1972; the 1992 Earth Summit in Rio de Janeiro; the 2002 Earth Summit in Johannesburg; the 2005 World Summit; and the Brundtland Commission on Environment and Development in 1987) have emphasized "sustainability," whether it be sustainable environment, sustainable economic development, sustainable agricultural and rural development, and so on. Accordingly, the designer has to address environmental and social issues and comply with local environmental protection codes. A number of tools and rating systems have been created by LEED (the United States), BREEAM (the United Kingdom), and HQE (France) in order to assess and compare the environmental performance of the buildings. These initiatives have a great impact on how buildings are designed, constructed, and maintained. Therefore, during implementation of building projects, the following need to be considered:

1. Accretion with the environment by using natural resources such as sunlight, solar energy, and appropriate ventilation configuration
2. Energy conservation by energy-efficient measures to diminish energy consumption
3. Environmental protection to reduce environmental impact
4. Use of materials harmonizing with the environment
5. Aesthetic match between a structure and its surrounding natural and built environment
6. Good air quality
7. Comfortable temperature
8. Comfortable lighting
9. Comfortable sound
10. Clean water
11. Less water consumption
12. Integration with social and cultural environment

During the design stage, the designer must work jointly with the owner to develop details regarding the owner's needs and give due consideration to

each part of the requirements. The owner on his part should ensure that the project objectives are

- Specific
- Realistic
- Measurable
- Agreed upon by all the team members
- Possible to complete within the stipulated time
- Within the budget

The following are the requirements for a building construction project, normally mentioned in the TOR, to be prepared by the designer during the conceptual phase for submission to the owner:

1. Site Plan
 - a. Civil
 - b. Services
 - c. Landscaping
 - d. Irrigation
2. Architectural Design
3. Building and Engineering Systems
 - a. Structural
 - b. Mechanical (HVAC)
 - c. Public Health
 - d. Fire Suppression Systems
 - e. Electrical
 - f. Low Voltage Systems
 - g. Others
4. Cost Estimates
5. Schedules

The designer is required to submit all the above requirements in the form of

- Report
- Drawings
- Models
- Presentation

4.3 Preliminary Design

Preliminary design is mainly a refinement of the elements in the conceptual design phase. Preliminary design is also known as *schematic design*. During this phase, the project is planned to a level where sufficient details are available for the initial cost and schedule. This phase also includes the initial preparation of all documents necessary to implement the facility/construction project. The central activity of preliminary design is the architect's design concept of the owner's objective, which can help make the detailed engineering and design for the required facility. Preliminary design is a subjective process transforming ideas and information into plans, drawings, and specifications of the facility to be built. Component/equipment configurations, material specifications, and functional performance are decided during this stage. At this stage, the owner can alter the scope and consider alternatives. The owner seeks to optimize certain facility features within the constraints of other factors such as cost, schedule, vendor capabilities, and so on.

Design is a complex process. Before design is begun, the scope must adequately define deliverables, that is, what will be furnished. These deliverables are design drawings, contract specifications, type of contracts, construction inspection record drawings, and reimbursable expenses.

Preliminary design is the basic responsibility of the architect (designer/consultant or A&E). In the case of building construction projects, a preliminary design determines

1. General layout of the facility/building/project
2. Required number of buildings/number of floors in each building/area of each floor
3. Different types of functional facilities required such as offices, stores, workshops, recreation, training centers, parking, etc.
4. Type of construction such as reinforcement concrete or steel structure, precast, or cast in situ
5. Type of electromechanical services required
6. Type of infrastructure facilities inside the facilities area
7. Type of landscape

The designer has to consider the following points while preparing the preliminary design:

1. Concept design deliverables
2. Calculations to support the design
3. System schematics for electromechanical system
4. Coordination with other members of the project team

5. Authorities' requirements
6. Availability of resources
7. Constructability
8. Health and safety
9. Reliability
10. Energy conservation issues
11. Environmental issues
12. Selection of systems and products that support the functional goals of the entire facility
13. Sustainability
14. Requirements of all stakeholders
15. Optimized life cycle cost (value engineering)

4.3.1 General Scope of Works/Basic Design

The purpose of a general scope of works is to provide sufficient information to identify the works to be performed and to allow detail design to proceed without significant changes that may adversely affect the project budget and schedule.

At the preliminary design stage, the scope must define deliverables, that is, what will be furnished. It should include a schedule of dates for delivering drawings, specifications, calculations and other information, forecasts, estimates, contracts, materials, and construction. The designer develops a design concept with the plan, elevation, and other related information that meet the owner's requirements. The designer also develops a concept of how various systems such as heating and cooling systems, communication systems, etc., will fit into the system.

Bennet (2003) has given a list of preliminary design drawings required for preliminary approval quoting one building agency of a U.S. state. These are

- The basic design approach drawn at an agreed-upon scale
- Site location in relationship to the existing environment
- Relation to master plans
- Circulation
- Organization of building functions
- Functional/aesthetic aspects of the design concepts under study
- Graphic description of critical details
- Visual and functional relationship
- Compatibility with the surrounding environment (p. 55)

Bennet (2003) further states that the same agency requires the design professional to prepare a narrative description of the following building systems upon completion of schematic design:

- Structure
- Floor grade and systems
- Roof
- Exterior/interior walls and partitions
- Interior finishes
- Sight lines
- Stairs and elevators
- Specialty items
- Electrical systems
- Mechanical systems
- Built-in equipment
- Site construction (p. 55)

4.3.2 Regulatory Approval

Once the preliminary design is approved, it should be submitted to regulatory bodies for their review and approval for compliance with the regulations, codes, and licensing procedure.

4.3.3 Budget

Based on the preliminary design, the budget is prepared by estimating the cost of activities and resources. The preparation of the budget is an important activity that results in a timed phased plan summarizing the expected expenses toward the contract and also the income or the generation of funds necessary to achieve the milestone. The budget for a construction project is the maximum amount the owner is willing to spend for design and construction of the facility that meets the owner's need. The budget is determined by estimating the cost of activities and resources and is related to the schedule of the project. If the cash flow or resulting budget is not acceptable, the project schedule should be modified. It is required that while preparing the budget, the risk assessment of the project is also performed.

4.3.4 Schedule

After the preliminary scope of works, the preliminary design and budget for the facility/project are finalized; the logic of the construction program is

set. On the basis of logic, a critical path method (CPM) schedule (bar chart) is prepared to determine the critical path and set the contract milestones.

4.3.5 Contract Terms and Conditions

Normally it is the consultant/designer team that is responsible for developing a set of contract documents that meets the owner's needs, and specifies the required level of quality, budget, and schedule. At this stage, a contract exists between the consultant and the client for the development of the project, and any good management test will demand that the contract be clearly understood by all parties associated with it. There are numerous combinations of contract arrangements for handling the construction projects; however, design/bid/build is predominantly used in most construction project contracts. This delivery system has been chosen by owners for many centuries and is called the traditional contracting system. In the traditional contracting system, the detailed design for the project is completed before tenders for construction are invited. The detailed engineering is carried out by the consultant/design professional to make the project qualitative and economical.

Based on the type of contracting arrangements with which the owner would like to handle the project, necessary documents are prepared by establishing a framework for execution of the project. Generally, FIDIC's model conditions for international civil engineering contracts are used as a guide to prepare these contract documents. Preliminary specifications and documents are prepared in line with model contract documents.

4.3.6 Value Engineering Study

Value engineering (VE) studies can be conducted at various phases of a construction project; however, the studies conducted in the early stage of a project tend to provide the greatest benefit. In most projects VE studies are performed during the schematic phase of the project. At this stage the design professionals have considerable flexibility to implement the recommendations made by the VE team, without significant impacts on the project's schedule or design budget. In certain countries for a project over US\$5 million, a VE study must be conducted as part of the schematic design process. The team members who perform the VE study depend on the client's/owner's requirement. It is advisable that a SAVE international registered certified value specialist be assigned to lead this study.

4.4 Detailed Design

Detailed design is the third phase of the construction project life cycle. It follows the preliminary design phase and takes into consideration the

configuration and the allocated baseline derived during the preliminary phase. Detailed design is also known as design development/detailed engineering. During this phase all suggested changes are reevaluated to ensure that the changes will not detract from meeting the project design goals/objectives. Detailed design involves the process of successively breaking down, analyzing, and designing the structure and its components so that it complies with the recognized codes and standards of safety, and performance while rendering the design in the form of drawings and specifications that will tell the contractors exactly how to build the facility to meet the owner's need. During this phase, detail design of the work, contract documents, detail plan, budget, estimated cash flow, regulatory approval, and tender/bidding documents are prepared. Depending on the type of contract the owner would like to have for completing the facility, the designer (consultant) can start preparing the detailed design. The success of a project is highly correlated with the quality and depth of the engineering plans prepared during this phase.

Figure 4.18 illustrates major activities in the detailed design phase.

4.4.1 Detail Design of the Works

The detail design process starts once the preliminary design is approved by the owner. Detail design is enhancement of work carried out during the preliminary stage. During this phase, a comprehensive design of the works with a detailed work breakdown structure and work packages are prepared. In general, specific and detailed scopes of works lead to better-quality projects. The detail design phase is the traditional realm of design professionals, including architects, interior designers, landscape architects, and several other disciplines such as civil, electrical, mechanical, and other engineers as needed.

Accuracy in the project design is a key consideration of the life cycle of the project; therefore, it is required that the designer/consultant be not only an expert in the technical field but also should have a broad understanding of engineering principles, construction methods, and value engineering. The designer must know the availability of the latest products in the market and to use proven technology, methods, and materials to meet the owner's objectives. He or she must refrain from using a monopolistic product, unless its use is important or critical for proper functioning of the system. He or she must ensure that at least two or three sources are available in the market producing the same type of product that complies with all its required features and intent of use. This will help the owner get competitive bidding during the tender stage.

The authors of *Quality in the Constructed Project* (ASCE, 2000) have listed the general functions and responsibilities of the design professional as follows:

- Being fully qualified and licensed to offer and provide the services contractually undertaken and provided
- Applying appropriate skills to the design

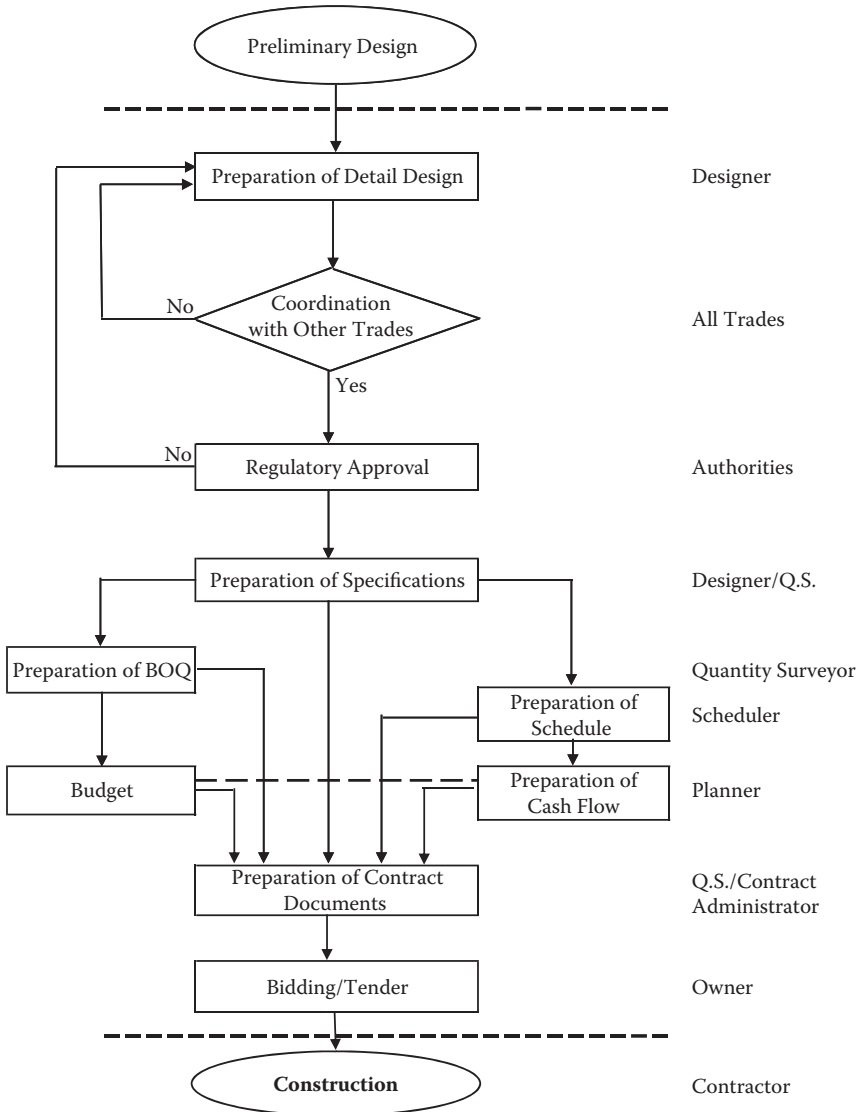

FIGURE 4.18

Major activities in the detailed design phase.

- Being proactive and clear in communication
- Being responsive to the established budget schedule and program
- Making timely interpretation, evaluation, and decisions
- Disclosing fully related external interests
- Avoiding conflicts of interest

- Complying with applicable codes, regulations, and laws
- Interpreting contract documents impartially
- Representing the owner's interests as required by contract
- Performing project-specific duties outlined in the contract between the design professional and owner (p. 30)

The authors of *Quality in the Constructed Project* (ASCE, 2000) further describe that the design professional (or in-house design team) can help ensure project quality through several activities, including

- Developing a scope of services that meet the owner's requirements and the project goals and objectives
- Developing a design activity plan for the project
- Defining project design guidelines
- Estimating accurately the hours of effort and costs involved in achieving a quality design
- Building flexibility into the design activity plan to allow for changes and future project development, as well as associated budget and schedule revisions
- Developing a realistic schedule with appropriate milestones to confirm progress
- Monitoring design progress constantly (p. 80)

Detail design activities are similar, although more in-depth than the design activities in the preliminary design stage. The size, shape, levels, performance characteristics, technical details, and requirements of all the individual components are established and integrated into the design. Design engineers of different trades have to take into consideration all these at a minimum while preparing the scope of works. The range of design work is determined by the nature of the construction project.

The following are the aspects of works to be considered by design professionals while preparing the detail design. These can be considered as a base for development of design to meet customer requirements and will help achieve the qualitative project.

4.4.1.1 Architectural Design

- Intent/use of building/facility
- Property limits
- Aesthetic look of the building
- Environmental conditions
- Elevations

- Plans
- Axis, grids, levels
- Room size to suit the occupancy and purpose
- Zoning per usage/authorities requirements
- Identification of zones, areas, rooms
- Modules to match with structural layout/plan
- Number of floors
- Ventilation
- Thermal insulation details
- Stairs, elevators (horizontal and vertical transportation)
- Fire exits
- Ceiling height and details
- Reflected ceiling plan
- Internal finishes
- Internal cladding
- Partition details
- Masonry details
- Joinery details
- Schedule of doors and windows
- Utility services
- Toilet details
- Required electromechanical services
- External finishes
- External cladding
- Glazing details
- Finishes schedule
- Special equipment
- Fabrication of items, such as space frame, steel construction, retaining wall, having special importance for appearance/finishes
- Special material/product to be considered, if any
- Any new material/product to be introduced
- Conveying system core details
- Ramp details
- Hard and soft landscape
- Parking areas

4.4.1.2 Concrete Structure

- Type of foundation
- Energy-efficient foundation
- Design of foundation based on field and laboratory tests of soil investigation that give the following information:
 - a. Subsurface profiles, subsurface conditions, and subsurface drainage
 - b. Allowable bearing pressure, and immediate and long-term settlement of footing
 - c. Coefficient of sliding on foundation soil
 - d. Degree of difficulty for excavation
 - e. Required depth of stripping and wasting
 - f. Methods for protecting below-grade concrete members against impact of soil and groundwater (water and moisture problems, termite control, and radon where appropriate)
 - g. Geotechnical design parameters such as angle of shear resistant, cohesion, soil density, modulus of deformation, modulus of sub-grade reaction, and predominant soil type
 - h. Design loads such as dead load, live load, wind load, and seismic load
- Grade and type of concrete
- Size of bars for reinforcement and the characteristic strength of bars
- Clear cover for reinforcement for
 - a. Raft foundation
 - b. Underground structure
 - c. Exposed to weather structure such as columns, beams, slabs, walls, and joists
 - d. Not exposed to weather columns, beams, slabs, walls, and joists
- Reinforcement bar schedule, stirrup spacing
- Location of columns in coordination with architectural requirements
- Number of floors
- Height of each floor
- Beam size and height of beam
- Superstructure:
 - a. Columns
 - b. Stairs

- c. Walls
 - d. Beams
 - e. Slabs
- Deflection that may cause fatigue of structural elements; cracks or failure of fixtures, fittings, or partitions; or discomfort to occupants
 - Movement and forces due to temperature
 - Equipment vibration criteria
 - Reinforcement bar schedule, stirrup spacing
 - Shaft and pit for conveying system
 - Building services to fit in the building
 - Environmental compatibility
 - Excavation
 - Dewatering
 - Shoring
 - Backfilling
 - Property limits/surrounding areas

4.4.1.3 Elevator Works

- Type of elevator
- Loading capacity
- Speed
- No. of stops
- Travel height
- Cabin, cabin accessories, cabin finishes, and car operating system
- Door, door finishes, and door system
- Safety features
- Drive, size, and type of motor
- Floor indicators, call button
- Control system
- Cab overhead dimensions
- Pit depth
- Hoist way
- Machine room
- Operating system

4.4.1.4 HVAC Works

- Environmental conditions
- Air-conditioning calculations
- Room pressurizing and leakage calculations
- Energy consumption calculations
- Air-conditioning calculations for IT equipment rooms
- Selection of chillers, cooling towers
- Selection of the duct work systems plant and equipment, for example, air-handling units, fan coil units, filters, coils, fans, humidifiers, duct heaters, etc.
- Selection of pumps
- Smoke extract ventilation calculations
- Exhaust ventilation calculations (toilets, chemicals storage, basement parking)
- Selection of fans
- Preparation of the plan and section layouts and plant room drawings
- Electrical load calculations
- Comparison of electrical consumption with electrical conservation code
- Ductwork sizing calculations
- Selection of the ductwork components such as balancing dampers, constant volume boxes, variable air volume boxes, attenuators, grills and diffusers, fire dampers, pressure relief dampers, etc.
- Pipework sizing calculations
- Selection of the inline pipe work components, for example, valves, strainers, air vents, commissioning sets, flexible connections, sensors, etc.
- Selection of boilers, pressurization units, air-conditioning calculations
- Pipework and duct work insulation selection
- Details of grills and diffusers, control valves, etc.
- Preparation of equipment schedules
- Control details
- HVAC-related electrical works
- Starter panels, MCC panels, schematic diagram of MCC
- Preparation of point schedule for building management system (BMS)
- Schematic diagram for BMS

4.4.1.5 Fire Protection System

The fire protection system provides protection against fire to life and property. The system is designed taking into consideration the local fire code and NFPA standards. The system includes the following:

- Sprinkler system for fire suppression in all the areas of the building
- Hydrants (landing valve) for professional fighting
- Hose reel for public use throughout the building
- Gaseous fire protection system for communication rooms
- Fire protection system for diesel generator room
- Size of fire pumps and controls
- Water storage facility
- Interface with other related systems

4.4.1.6 Plumbing Works

- Maximum working pressure to have adequate pressure and flow of water supply
- Maximum design velocity
- Maximum probable demand
- Demand weight of fixture in fixture units for public uses
- Friction loss calculation
- Maximum hot water temperature at fixture outlet
- Water heater outlet hot temperature
- Providing isolating valves to ensure that the system is easily maintainable
- Hot water system
- Central water storage capacities
- Size of pumps and controls
- Location of storage tank
- Schematic diagram for water distribution system

4.4.1.7 Drainage System

While designing the drainage system, the schedule of foul drainage demand units and frequency factors for the following items should be considered for sizing the piping system, number of manholes, and capacity of sump pump, capacity of sump pit:

- Washbasins
- Showers
- Urinals
- Restrooms
- Kitchen sinks
- Other equipment such as dishwashers and washing machines

4.4.1.8 Electrical System

- Lighting calculations for different areas based on illumination level recommended by CIE/CEN/CIBSE and Isolux diagrams
- Selection of light fittings, type of lamps
- Exit/Emergency lighting system
- Circuiting references, normal as well as emergency
- Power for wiring devices
- Power supply for equipment (HVAC, PH & FF, conveying system, others)
- Sizing of conduits
- Sizing of cable tray
- Sizing of cable trunking
- Selection of wires and cables
- Voltage drop calculations for wires and cables
- Selection of upstream and downstream breakers
- Derating factor
- Sensitive of breakers (degree of protection)
- Selection of isolators
- Schedule of distribution boards, switchboards, and main low tension boards
- Location of distribution boards, switch boards and low tension panels
- Short circuit calculations
- Sizing of diesel generator set for emergency supply
- Sizing of transformers
- Schematic diagrams
- Substation layout
- IP ratings (degree of protection)
- Calculations for grounding (earthing) system
- Calculations for lightning protection system
- Interface with other trades

4.4.1.9 Fire Alarm System

A fire alarm system is designed taking into consideration the local fire code and NFPA standards. The system includes the following:

- Conduiting and raceways
- Type of system: analog/digital /addressable
- Type of detectors based on the area and spacing between the detectors and the walls
- Break glass/pull station
- Type of horns/bells
- Voice evacuation system, if required
- Type of wires and cables
- Mimic panel, if required
- Repeater panel, if required
- Main control panel
- Interface with other systems such as HVAC, elevator
- Riser diagram

4.4.1.10 Telephone/Communication System

- Structured cabling considering type and size of cable: copper, fiber optic
- Type and size of the cables
- Racks
- Wiring accessories/devices
- Access/distribution switches
- Internet switches
- Core switch
- Access gateway
- Router
- Network management system
- Servers
- Telephone handsets

4.4.1.11 Public Address System

- Conduiting and raceways
- Type of system: analog/digital/IP based
- Types of wires and cables

- Types of speakers
- Distribution of speakers
- Required noise level in different areas
- Calculations for sound pressure level
- Zoning of system, if required
- Size and type of pre-mixer
- Size and type of amplifier
- Microphones
- Paging system
- Message recorder/player
- Interface with other systems

4.4.1.12 Audiovisual System

- Conduiting and raceways
- Type of system: analog/digital/IP based
- Types of wires and cables
- Racks
- Type, size, and brightness of projectors
- Type and size of speakers and sound pressure level
- Type and size of screens
- Microphones
- Cameras (visualizers)
- CD/DVD players-recorders
- Control processors
- Video switch matrix
- Mounting details of equipment

4.4.1.13 Security System/CCTV

- Type of system: digital/IP based
- Conduiting and raceways
- Wires and cabling network
- Level of security required
- Type and size of cameras
- Types of monitors/screens
- Video/event recording
- Video servers

- Database server
- System software
- Schematic diagram
- System console

4.4.1.14 Security System Access Control

- Conduiting and raceways
- Wires and cabling network
- Proximity RFID reader
- Fingerprint and proximity combine reader
- Magnetic lock
- Release button
- Door contact
- RFID card
- Reader control panel
- Server
- Multiplexer
- Monitors
- Workstation
- Metal detector

4.4.1.15 Landscape

As a landscape architect, the following points are to be considered while designing the landscape system:

- Property boundaries
- Size and shape of the plot
- Shape and type of dwelling
- Integration with surrounding areas
- Orientation to the sun and wind
- Climatic/environmental conditions
- Ecological constraints (soil, vegetation, etc.)
- Location of pedestrian paths and walkways
- Pavement
- Garage and driveway
- Vehicular circulation

- Location of sidewalk
- Play areas and other social/community requirements
- Outdoor seating
- Location of services, positions of both under- and aboveground utilities and their levels
- Location of existing plants, rocks, or other features
- Site clearance requirements
- Foundation for paving, including front drive
- Top soiling, or top soil replacement
- Soil for planting
- Planting of trees, shrubs, and ground covers
- Grass area
- Sowing grass or turfing
- Lighting poles/bollard
- Special features, if required
- Signage, if required
- Surveillance, if required
- Installation of irrigation system
- Marking out the borders
- Storage for landscape maintenance material

4.4.1.16 External Works (Infrastructure and Road)

External works are part of the contract requirements of a project that involves construction of a service road and other infrastructure facilities to be connected to the building and also includes care of existing services passing through the project boundary line. The designer has to consider the following while designing external works:

- Grading material
- Asphalt paving for road or street
- Pavement
- Pavement marking
- Precast concrete curbs
- Curbstones
- External lighting
- Cable routes
- Piping routes for water, drainage, storm water system
- Trenches or tunnels
- Bollards

- Manholes and hand holes
- Traffic marking
- Traffic signals
- Boundary wall/retaining wall, if required

4.4.1.17 Bridges

Designer should use relevant authorities' design manual and standards and consider the following points while designing bridges.

- Soil stability
- Alignment with road width, property lines
- Speed
- Intersections/interchanges
- No. of lanes, width
- Right-of-way lines
- Exits, approaches, and access
- Elevation datum
- Superelevation
- Clearance with respect to railroad, roadway, navigation (if applicable)
- High and low levels of water (if applicable)
- Utilities passing through the bridge length
- Slopes
- Number and length of span
- Live loads, bearing capacity
- Water load, wind load, earthquake effect (seismic effect)
- Bridge rails, protecting screening, guard rails, barriers
- Shoulder width
- Footings, columns, and piles
- Abutment
- Beams
- Substructure
- Super structure, deck slab
- Girders
- Slab thickness
- Reinforcement
- Supporting components, deck hanger, tied arch

- Expansion and fixed joints
- Retaining walls, crash wall
- Drainage
- Lighting
- Aesthetic
- Sidewalk, pedestrian and bike facilities
- Signage, signals
- Durability
- Sustainability

4.4.1.18 Highways

Designer should use relevant authorities' design manual and standards and consider the following point while designing highways.

- Type of highway
- Soil stability
- Speed
- No. of lanes, width
- Shoulder width
- Gradation
- Type of pavement and thickness
- Right-of-way lines
- Exits, approaches, access, and ramp
- Superelevation
- Slopes, curvature, turning
- Median, barriers, curb
- Sidewalks, driveways
- Pedestrian accommodation
- Bridge roadway width
- Drainage
- Gutter
- Special conditions, such as snow and rain
- Lighting
- Signage, signals
- Durability
- Sustainability

4.4.1.19 Furnishings/Furniture (Loose)

In building construction projects, loose furnishings/furniture is tendered as a special package and is normally not the part of the main contract. In order to give sufficient information about the product, the descriptive features and specifications of the furnishing/furniture products are accompanied by a pictorial view/cutout sheet/photo of the product and the furniture layout. Figures 4.19 to 4.24 illustrate the detailed specifications for the furnishing of the director’s and manager’s room of an office building.

It is unlikely that the design of a construction project will be right in every detail the first time. Effective management and design professionals who are experienced and knowledgeable in the assigned task will greatly reduce the chances of error and oversight. However, so many aspects must be considered, especially for designs involving multiple disciplines and enfaces, and changes will be inevitable. The design should be reviewed taking into consideration requirements of all the disciplines before release of design drawings for a construction contract. Engineering design has significant importance to the construction projects and must meet the customer’s requirement at the start of project implementation. Engineering design has significant importance for construction projects. Engineering weakness can adversely impact the quality of design to such an extent that marginal

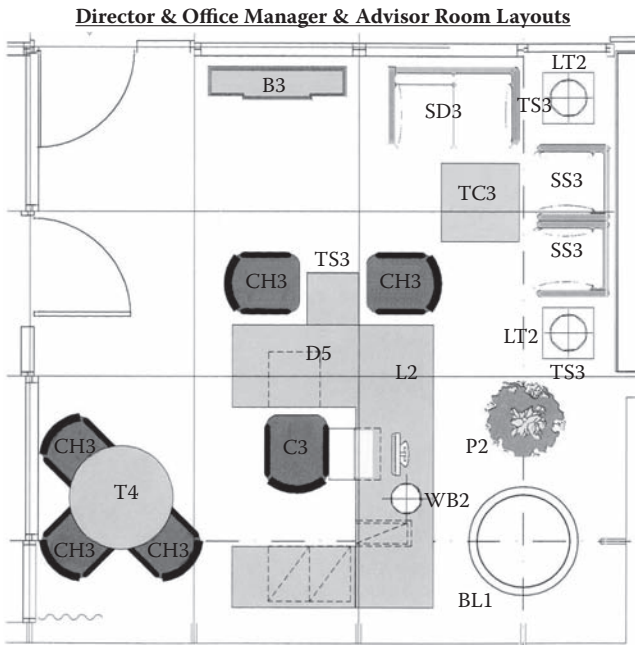
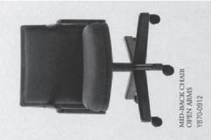

FIGURE 4.19
Room layout.



Desk
(D5 & D6)

Desk Chair
(C3)



Meeting & Guest Chair
(CH3)



Meeting Table
(T4)



General Low Table & Side
Table
(TC3 & TS3)



Buffer Credenza
(B3)

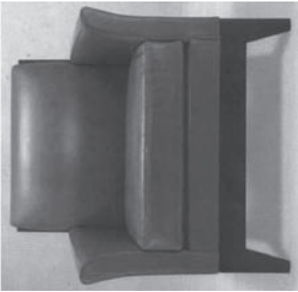

Single & Two Seater
Sofa (SS3 & SD3)

Task Lamp
(L2 & LT2)

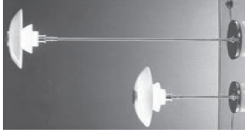

Planting Container
(P2)



Waste Baskets
(WB2)

FIGURE 4.20
Furniture index.

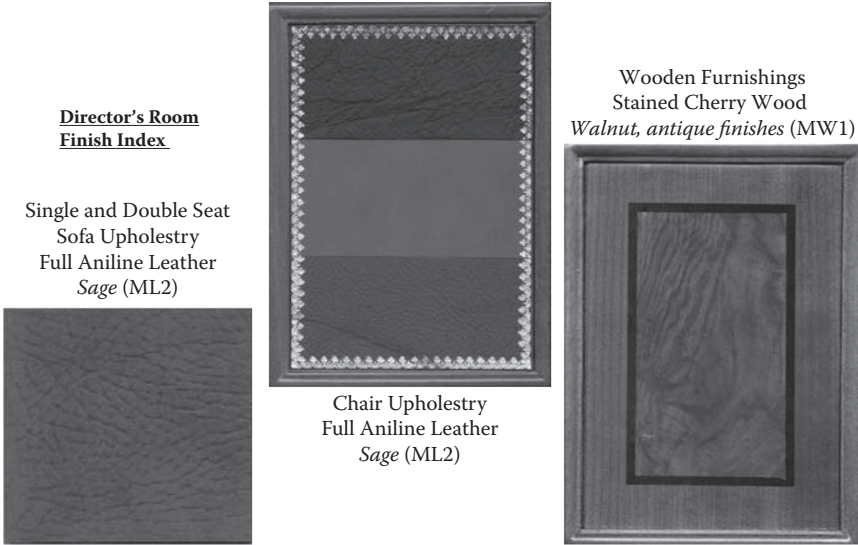

FIGURE 4.21
Finishes index.

DESCRIPTION: Desk units			CODE: D5 & D6		QUANTITY:
LOCATION	RECOMMENDED MANUFACTURERS	OPTION ONE HAWORTH	OPTION TWO STEELCASE	OPTION THREE KIMBALL	OR APPROVED EQUAL
<p>DIMENSIONS: (as shown on the drawing) D5: H 760 mm x D 914mm x W 2030mm, Credenza H760 mm x D 508mm x W 2030mm and Bridge: H 760mm x D 810mm x L 1200mm D6: H 760 mm x D 914mm x W 1830mm, Credenza H760 mm x D 508mm x W 1830mm and Bridge: H 760mm x D 810mm x L 1200mm ;</p> <p>SPECIFICATIONS / CONSTRUCTION: The contractor to check the number of right-handed and left-handed desk units prior to order. High grade executive desk with full front modesty panel made of kiln dried cherry wood with walnut antique finish as specified as per engineer's control sample with solid traditional moulding polished in walnut finish. The table top is constructed of 22mm high density marine grade MDF with stained walnut with three pencil drawers as shown in figure. The pattern along the top edge should match the wall paneling pattern and is to be approved prior to order and manufacture. The desk with bridge and credenza's top to have tanned aniline dyed leather inlay of color same as desk chair.</p> <p>Two full fixed pedestal to be with box/ box/ box and the credenza to have four full fixed pedestals with box/ fix fixed below the pencil drawer and should also have back finished panel. The central drawer to have pencil tray. For detailed specifications, refer appendix C.</p> <p>FINISHES: Top to have leather inlay and all hardware and other accessories to be in chrome finish (brass finish for level B only). The contractor to submit different ranges of the specified color to get the approval and match engineer's control sample and prior to order. All exposed wood machine sanded; Pieces pre-stained to check for scratches; Pre-stain completely sanded off, lacquered on spray - catalyzed urethane or catalyzed conversion varnish topcoat. Wooden parts must be stained walnut, antique finish; to match engineer's sample prior to order.</p>					
<p>REMARKS: This specification work format is just design intent, must be read in conjunction with other schedules and all relevant drawings; all dimensions must be verified in site prior to order or manufacture of materials or production of shop drawings. The Contractor must fully coordinate with all other engineering works, especially the layout & visual works, to ensure proper installation. All necessary accessories, optional features, hardware including locks with keys etc., all to be included in order to make each item complete fully functional with maximum utility. The finishes required must be verified with respect to architectural intentions, wall paneling and coordinate in approval with respect to the engineer's control sample prior to order or manufacture.</p>					

FIGURE 4.22
Specification for desk units.

changes can easily increase costs beyond the budget, which may affect schedule. Some areas are deemed critical to the proper design of a product; therefore, explicit design, material specification, and grades of the material specified in documentation have great importance. Most of the products used in construction projects are produced by other construction-related

DESCRIPTION: Desk Lamp		CODE:			QUANTITY:
LOCATION	RECOMMENDED MANUFACTURERS	OPTION ONE	OPTION TWO	OPTION THREE	OR APPROVED EQUAL
	Louis Poulsen		W & D	PORTA ROMANA	
<p>DIMENSIONS: (shape and size to be verified as per architectural interiors' drawings and prepared shop drawings at site) H 472 mm x W 260mm</p> <p>SPECIFICATIONS / CONSTRUCTION: The shade is of blown glass with a top plate and base of flow formed high polished chrome. The stem is high luster steel plated brass. The desk lamp is fitted with a 2.5m black plastic cable with plug and toggle switch in the base plate. It should be of IP20 protection code and electric shock protection Class II. Light source 150 W.</p> <p>FINISHES: Transparent blown glass.</p> <p>All hardware and other accessories to be in polished chrome finish (from level 3-7) & brass finish (for level 8).</p> <p>The contractor to submit different ranges of colors to get the approval and match engineer's control sample and prior to order.</p>					
<p>REMARKS: This specification work format is just design intent, must be read in conjunction with other schedules and all relevant drawings, all dimensions must be verified on site prior to order or manufacture of materials or production of shop drawings. The Contractor must fully coordinate with all other engineering works, especially the audio & visual works to ensure proper installation. All necessary accessories, optional features, hardware including locks with keys etc., all to be included in order to make each item complete fully functional with maximum utility. The finishes required must be verified with respect to architectural interiors, wall paneling and coordinate its approval with respect to the engineer's control sample prior to order or manufacture.</p>					

FIGURE 4.23
Specification for desk lamp.

DESCRIPTION: Single and Two Seater Sofa		CODE:			QUANTITY:
LOCATION	RECOMMENDED MANUFACTURERS	OPTION ONE	OPTION TWO	OPTION THREE	OR APPROVED EQUAL
	David Edward				
<p>DIMENSIONS: SD3: W 1350 X D 750 X H 810 MM SS3: W 720 X D 750 X H 810 MM</p> <p>SPECIFICATIONS / CONSTRUCTION: Executive hand craved family sofas fully upholstered seat and back, with closed wooden topped arms upholstered in full aniline leather. The frame is constructed of kiln dried hard cherry. Mortise / tenon on main joinery; in solid parts but stained in walnut, antique finish. The chair with carved legs. The seat and back are upholstered with leather approved by the engineer and are trim nailed with brass pins. Ultraflex seat construction stretched an additional 20% for firm seat. Back: high strength nylon weaves, 3430 Propax, stretched & stapled to frame; Polyurethane foam. All construction materials to meet CAL 117. Pre-upholstered muslin or bonded Dacron. Eight-way bed seat springs, pocket sprung back with frames all glued, screwed and dowelled together. For additional specifications for wood, refer appendix C and for upholstery specification, refer appendix G. It consists of spring down seat cushion that is made of: an insulating box of high quality density polyurethane foam filled with coil springs individually wrapped and held in place by fabric pockets. The unit is inserted into a down-proof envelope of fabric ticking that is channeled into sections on the top and bottom. Each ticking section is filled with a special blend of down, feathers and polyester fiber to achieve luxurious softness and resilience. The down content is 25% and 75% feathers.</p> <p>FINISHES: Seat and both sides of back are upholstered in fully in full aniline leather. The contractor to submit different ranges of colors to get the approval and match engineer's control sample and prior to order. All exposed wood machine sanded, Pieces pre-stained to check for scratches. Pre-stain completely sanded off - lacquered on spray - catalyzed urethane or catalyzed conversion varnish top coat. Wooden parts must be stained walnut, antique finish; to match engineer's sample prior to order.</p>		<p>GRAPHICAL REPRESENTATION</p> 			
<p>REMARKS: This specification work format is just design intent, must be read in conjunction with other schedules and all relevant drawings, all dimensions must be verified on site prior to order or manufacture of materials or production of shop drawings. The Contractor must fully coordinate with all other engineering works, especially the audio & visual works to ensure proper installation. All necessary accessories, optional features, hardware including locks with keys etc., all to be included in order to make each item complete fully functional with maximum utility. The finishes required must be verified with respect to architectural interiors, wall paneling and coordinate its approval with respect to the engineer's control sample prior to order or manufacture.</p>					

FIGURE 4.24
Specification for sofa.

industries/manufacturers; therefore, the designer, while specifying the products, must specify related codes, standards, and technical compliance of these products.

CII Publication 10-1 (1989) has summarized that deviation costs averaged 12.4% of the total installed project cost; design deviation averaged 79% of the total deviation costs and 9.5% of the total project cost. Furthermore, design

TABLE 4.7

Major Causes of Rework, by Phase

Primary Cause Party and Type	When Detected (Phase)			
	Design	Procurement	Construction	Startup
Owner change	X	X	X	X
Designer error/omission	X	X	X	X
Designer change	X	X	X	X
Vendor error/omission	X	X	X	X
Vendor change	X	X	X	X
Constructor error/omission			X	
Constructor change			X	
Transporter error		X	X	X

Source: CII Publication 10-3. Reprinted with permission of CII, University of Texas.

changes accounted for two-thirds of the design deviations. It has also given construction deviation averages, which are

- 17% of the total deviation costs
- 2.5% of the total installed project cost

It further states that design deviation related to construction projects are results of design errors and design omissions. Design errors are the result of mistakes or errors made in the project design. Design omissions result when a necessary item or component is omitted from the design. Design changes occur when changes are made in the project design or requirements.

Table 4.7 shows the major causes of rework.

In order to reduce the rework resulting from quality deviation in design, CII Publication 10-1 (1989) has made the following recommendations:

1. Reduce the number of design changes by:
 - Establishing definitive project scope
 - Performing periodic reviews with participation of all parties
 - Establishing procedures to limit scope modifications
2. Implement a quality management program that has total commitment at all levels of the firm
3. Adopt the standard set of quality related terminology
4. Develop and implement a system that incorporates a database to identify deviation costs and quality problem areas
5. Implement a quality performance management system to identify costs associated with both quality management and correcting deviation costs (p. 11)

It is, therefore, necessary to have quality control personnel from the project team review and check the design for quality assurance using thorough itemized review checklists to ensure that design drawings fully meet the owner's objectives/goals. Appendix A contains illustrative design review

checklists for architectural work, structural work, HVAC work, plumbing and fire protection systems, electrical systems, and landscape and infrastructure works. It is also necessary to review the design with the owner prior to initiation of work to ensure a mutual understanding of the build process. The design drawings should be fully coordinated with all the trades. The installation specification details are comprehensively and correctly described, and the installation quality requirements for systems are specified in detail.

Figure 4.25 illustrates the design data review cycle, which can be applied to review construction project design drawings. This process can be termed as continuous improvement of design.

4.4.2 Regulatory/Authorities' Approval

Government agency regulatory requirements have considerable impact on precontract planning. Some agencies require that the design drawings be submitted for their preliminary review and approval to ensure that the designs are compatible with local codes and regulations. These include submission of drawings to electrical authorities showing the anticipated electrical load required for the facility, approval of fire alarm and fire fighting system drawings, and approval of drawings for water supply and drainage system. Technical details of the conveying system are also required to be submitted for approval from the concerned authorities.

4.4.3 Contract Documents and Specifications

Preparation of detailed documents and specifications per master format is one of the activities performed during this phase of the construction project. The contract documents must specify the scope of works, location, quality, and duration for completion of the facility. As regards the technical specifications of the construction project, master format specifications are included in the contract documents. The master format is a master list of section titles and numbers for organizing information about construction requirements, products, and activities into a standard sequence. It is a uniform system for organizing information in project manuals, for organizing cost data, for filling product information and other technical data, for identifying drawing objects, and for presenting construction market data. MasterFormat™ (1995 edition) consisted of 16 divisions; however, MasterFormat (2004 edition) consists of 48 divisions (49 is reserved). MasterFormat contract documents produced jointly by the Construction Specifications Institute (CSI) and Construction Specifications Canada (CSC) are widely accepted as standard practice for preparation of contract documents.

Table 4.8 lists division numbers and titles of MasterFormat 2004 published by the Construction Specifications Institute and Construction Specifications Canada.

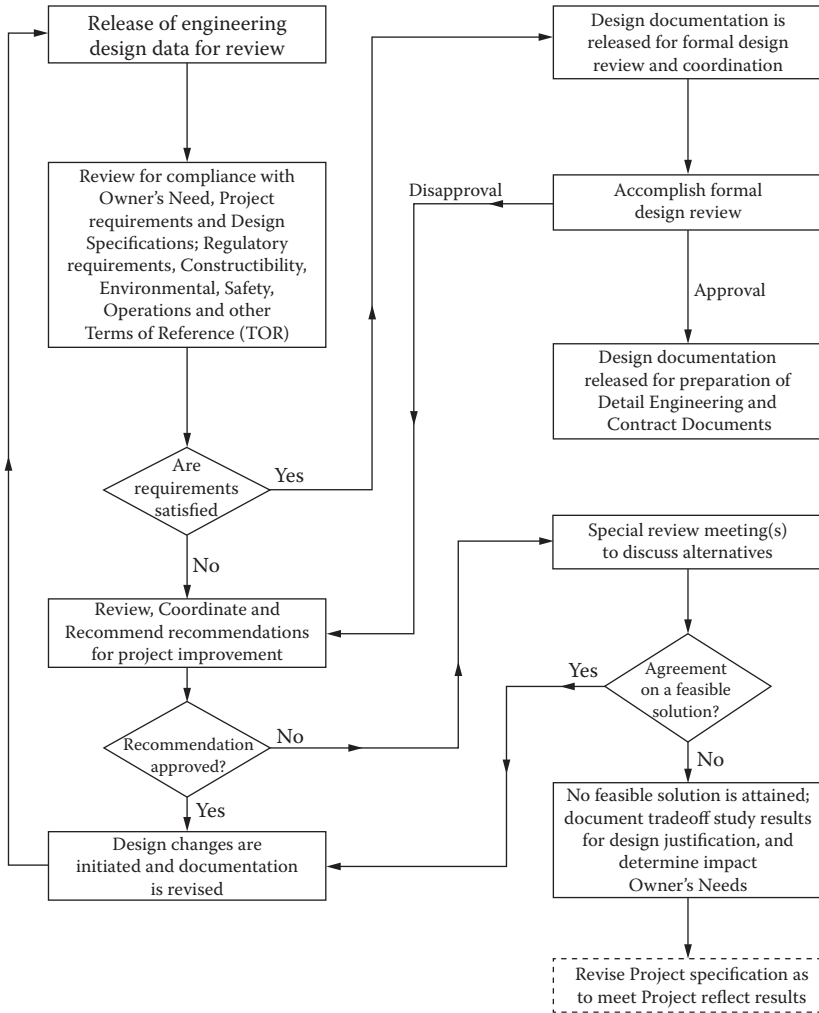

FIGURE 4.25 Design data review cycle. (Modified from B.S. Blanchard, W.J. Fabrycky, and J. Wolter. *Systems Engineering and Analysis*, 1998. Reprinted with permission from Pearson Education, Inc.)

Particular specifications consist of many sections related to a specific topic. Detailed requirements are written in these sections to enable the contractor understand the product or system to be installed in the construction project. The designer has to interact with the project team members and owner while preparing the contract documents.

Typical sections are as follows.

TABLE 4.8

MasterFormat 2004 Division Numbers and Titles

Procurement and Contracting Requirements Group	
Division 00 Procurement and Contracting Requirements	
Specifications Group	
General Requirements Subgroup	
Division 01	General Requirements
Facility Construction Subgroup	
Division 02	Existing Conditions
Division 03	Concrete
Division 04	Masonry
Division 05	Metals
Division 06	Wood, Plastics, and Composites
Division 07	Thermal and Moisture Protection
Division 08	Openings
Division 09	Finishes
Division 10	Specialties
Division 11	Equipment
Division 12	Furnishings
Division 13	Special Construction
Division 14	Conveying Equipment
Division 15	Reserved
Division 16	Reserved
Division 17	Reserved
Division 18	Reserved
Division 19	Reserved
Facility Services Subgroup	
Division 20	Reserved
Division 21	Fire Suppression
Division 22	Plumbing
Division 23	Heating, Ventilation, and Air Conditioning
Division 24	Reserved
Division 25	Integrated Automation
Division 26	Electrical
Division 27	Communication
Division 28	Electronic Safety and Security
Division 29	Reserved
Site and Infrastructure Subgroup	
Division 30	Reserved
Division 31	Earthwork
Division 32	Exterior Improvements

TABLE 4.8 (Continued)

MasterFormat 2004 Division Numbers and Titles

Procurement and Contracting Requirements Group	
Division 00 Procurement and Contracting Requirements	
Site and Infrastructure Subgroup	
Division 33	Utilities
Division 34	Transportation
Division 35	Waterway and Marine
Construction	
Division 36	Reserved
Division 37	Reserved
Division 38	Reserved
Division 39	Reserved
Process Equipment Subgroup	
Division 40	Process Integration
Division 41	Material Processing and Handling Equipment
Division 42	Process Heating Cooling, and Drying Equipment
Division 43	Process Gas and Liquid Handling, Purification, and Storage Equipment
Division 44	Pollution Control Equipment
Division 45	Industry-Specific Manufacturing Equipment
Division 46	Reserved
Division 47	Reserved
Division 48	Electric Power Generation
Division 49	Reserved

Source: The Construction Specifications Institute and Construction Specifications Canada. Reprinted with permission from CSI.

Section No.

Title

Part 1—General

- 1.01—General Reference/Related Sections
- 1.02—Description of Work
- 1.03—Related Work specified elsewhere in other sections
- 1.04—Submittals
- 1.05—Delivery, Handling, and Storage

1.06—Spare Parts

1.07—Warranties

In addition to the foregoing, a reference is made for items such as preparation of mock-up, quality control plan, and any other specific requirements related to the product or system specified herein.

Part 2—Product

2.01—Materials

2.02—List of Recommended Manufacturers

Part 3—Execution

3.01—Installation

3.02—Site Quality Control

Shop Drawing and Materials Submittals

The detailed procedure for submitting shop drawings, materials, and samples is specified under the section titled “SUBMITTAL” of contract specifications. The contractor has to submit the specifications to the owner/consultant for review and approval. The following are the details of preparation of shop drawings and materials.

A—Shop Drawings

The contractor is required to prepare shop drawings taking into account the following partial list of considerations:

1. Reference to contract drawings. This helps the A&E (consultant) to compare and review the shop drawing with the contract drawing
2. Detail plans and information based on the contract drawings
3. Notes of changes or alterations from the contract documents
4. Detailed information about fabrication or installation of works
5. Verification of all dimensions at the job site
6. Identification of product

7. Installation information about the materials to be used
8. Type of finishes, color, and textures
9. Installation details relating to the axis or grid of the project
10. Roughing in and setting diagram
11. Coordination certification from all other related trades (subcontractors)

The shop drawings are to be drawn accurately to scale and shall have project-specific information in it. They should not be reproductions of contract drawings.

Immediately after approval of individual trade shop drawings, the contractor has to submit builder's workshop drawings, composite/coordinated shop drawings taking into consideration the following at a minimum.

A1—Builder's Workshop Drawings

Builder's workshop drawings indicate the openings required in the civil or architectural work for services and other trades. These drawings indicate the size of openings, sleeves, and level references with the help of detailed elevation and plans.

A2—Composite/Coordination Shop Drawings

The composite drawings indicate the relationship of components shown on the related shop drawings and indicate the required installation sequence. Composite drawings should show the interrelationship of all services with one another and with the surrounding civil and architectural work. Composite drawings should also show the detailed coordinated cross sections, elevations, reflected plans, etc., resolving all conflicts in levels, alignment, access, space, etc. These drawings are to be prepared taking into consideration the actual physical dimensions required for installation within the available space.

B—Materials

Similarly, the contractor has to submit the following, at a minimum, to the owners/consultants to get their review and approval of materials, products, equipment, and systems. The contractor cannot use these items unless they are approved for use in the project.

B1—Product Data

The contractor has to submit the following details:

- Manufacturer's technical specifications related to the proposed product

- Installation methods recommended by the manufacturer
- Relevant sheets of manufacturer's catalogs
- Confirmation of compliance with recognized international quality standards
- Mill reports (if applicable)
- Performance characteristic and curves (if applicable)
- Manufacturer's standard schematic drawings and diagrams to supplement standard information related to project requirements and configuration of the same to indicate product application for the specified works (if applicable)
- Compatibility certificate (if applicable)
- Single-source liability (this is normally required for systems approval when different manufacturers' items are used)

B2—Compliance Statement

The contractor has to submit a specification comparison statement along with the material transmittal.

The consultant reviews the transmittals and action as follows:

- a. Approved
- b. Approved as noted
- c. Approved as noted, resubmit
- d. Not approved

In certain projects, the owner is involved in approval of materials.

In case of any deviation from specifications, the contractor has to submit a schedule of such deviations listing all the points not conforming to the specification.

B3—Samples

The contractor has to submit (if required) the samples from the approved material to be used for the work. The samples are mainly required to

- Verify color, texture, and pattern
- Verify that the product is physically identical to the proposed and approved material
- Comparison with products and materials used in the works

At times it may be specified to install the samples in such a manner as to facilitate review of qualities indicated in the specifications.

Contractor's Quality Control Plan (CQCP)

The contract documents specify the details of the contents of the Quality Control Plan (QCP) to be prepared by the contractor for the construction project; the plan has to be submitted to the consultant for approval. The following is the outline for preparation of a QCP:

1. Purpose of the QCP
2. Project description
3. Site staff organization chart for quality control
4. Quality control staff and their responsibilities
5. Construction program and subprograms
6. Schedule for submission of subcontractors, manufacturer of materials, and shop drawings
7. QC procedure for all the main activities such as
 - a. Procurement (direct bought out items)
 - b. Off-site manufacturing, inspection, and testing
 - c. Inspection of site activities (checklists)
 - d. Inspection and testing procedure for systems
 - e. Procedure for laboratory testing of material
 - f. Inspection of material received at site
 - g. Protection of works
8. Method statement for various installation activities
9. Project-specific procedures for site work instructions, and remedial notes
10. Quality control records
11. List of quality procedures applicable to project in reference to the company's quality manual and procedure
12. Periodical testing procedure for construction equipment and tools
13. Quality updating program
14. Quality auditing program
15. Testing
16. Commissioning
17. Handover
18. Site safety

Specifications of work quality are an important feature of construction project design. Specifications of required quality and components represent part

of the contract documents and are detailed under various sections of particular specifications. Generally, the contract documents include all the details as well as references to generally accepted quality standards published by international standards organizations. Proper specifications and contract documentations are extremely important as these are used by the contractor as a measure of quality compliance during the construction process.

A contract for construction commits the contractor to construct the facility and the owner to pay. Once the contract is signed, it commits all the parties to obligations and liabilities and is enforceable by law. A breach of contract by either party may make that party liable for payment of damages to the other.

There are standard sets of conditions of contract published by engineering institutes/societies and other bodies. Depending on the need for the construction project and the type of contract arrangements, an appropriate set of condition of contracts is selected. The contract document must include health and safety programs to be followed by the contractor during the construction process.

4.4.4 Detail Plan

Per PMBOK, a project plan is used to

- Guide project execution
- Document project planning assumptions
- Document project planning decisions regarding alternatives chosen
- Define key management views regarding content, scope, and timing
- Provide a baseline for progress measurement and project control

A project plan is a formal, approved document used to manage project execution. It is the evaluation of time and effort to complete the project. Based on the detailed engineering and design drawings and contract documents, the design team (consultant) prepares a detail plan for construction. The plan is based on the following:

- Assessment of owner's capabilities and final estimated cost (budget)
- Scheduling information
- Resource management, which includes availability of financial resources, expected cash flow statement, supplies, and human resources

A typical preliminary work program prepared based on the contracted construction documents is illustrated in Figure 4.26.

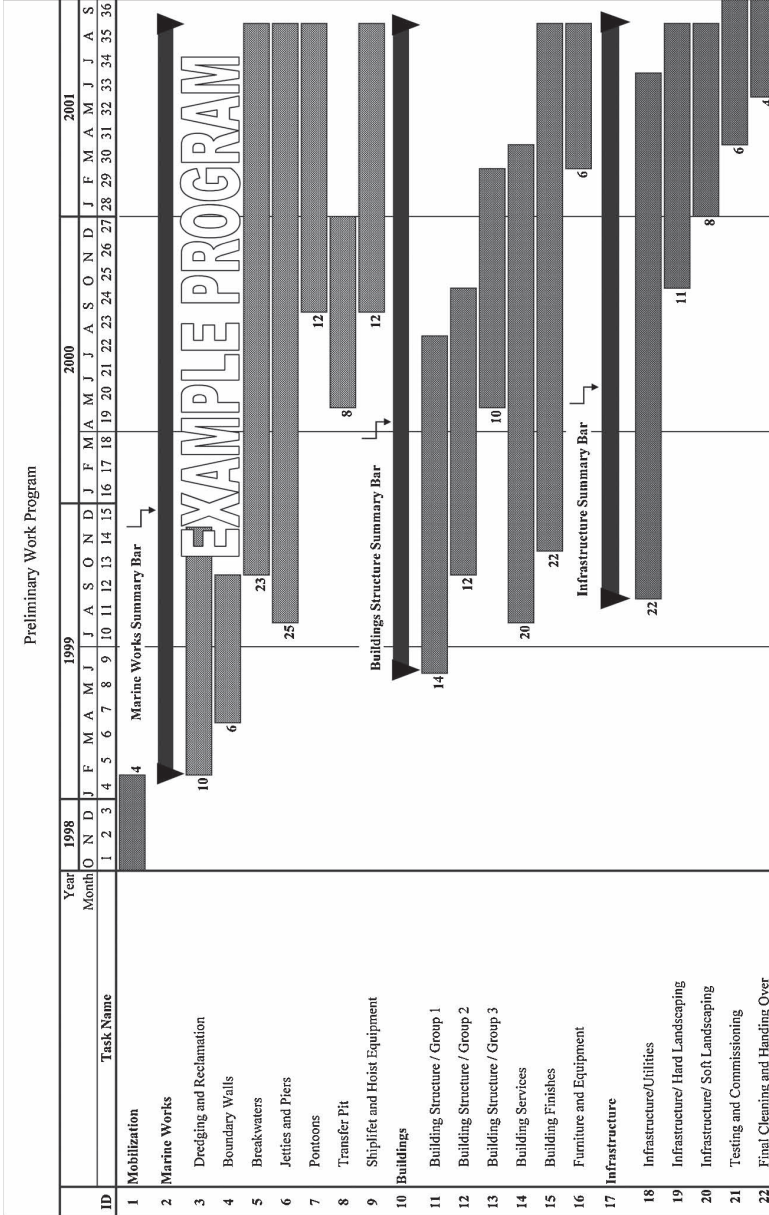

FIGURE 4.26 Preliminary work program.

4.4.5 Budget

The budget for a project is the maximum amount of money the owner is willing to spend for its design and construction. The preparation of a budget is an important activity that results in a time-phased plan summarizing expected expenditure, income, and milestones. Normally, project budgeting starts with the identification of need; however, the detailed cost estimate is done during the engineering phase. On the basis of work packages, the consultant/designer starts computing the project budget. A bill of material or bill of quantities is prepared based on the approved design drawings. The BOQ is considered as a base for computing the budget. If the budget exceeds the owner’s capability of financing the project, then the designs are reviewed to ensure that it meets the owner’s estimated cost to build the facility.

Figure 4.27 illustrates a project S-curve for a building construction project.

4.4.6 Cash Flow

The estimate of cash flow requirement for the project is prepared from the preliminary estimate and preliminary work program. An accurate cash flow projection helps owners plan the payments on time per the schedule for the project. A simple cash flow projection based on prior planning helps owners make available all the resources required from their side. Cash flow is used as part of the control package during construction.

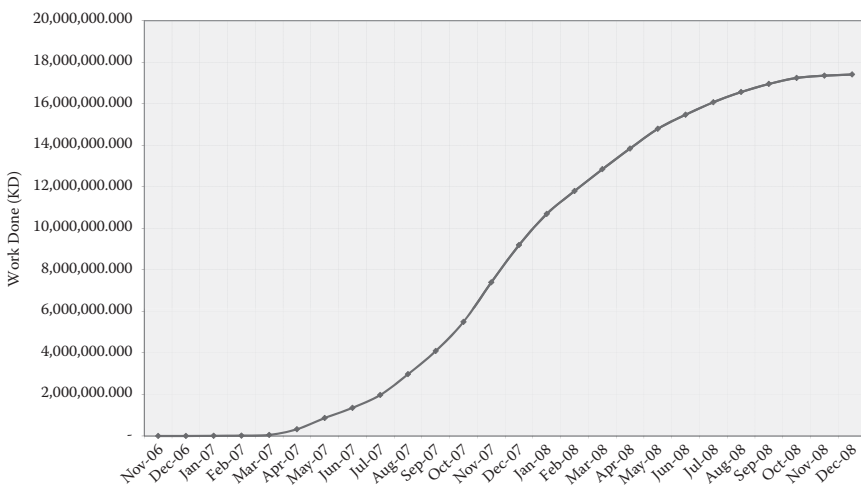

FIGURE 4.27
Project S-curve.

4.4.7 Tender/Bidding

Most of the cost of the construction project is expended during the construction phase. In most cases, the contractor is responsible for procurement of all the material, providing construction equipment and tools, and supplying the manpower to complete the project in compliance with the contract documents.

Table 4.9 lists contract documents consisting of tendering procedures, contract conditions, and technical conditions of major construction projects in Kuwait.

In many countries, it is a legal requirement that government-funded projects employ the competitive bidding method. This requirement gives an opportunity to all qualified contractors to participate in the tender, and normally the contract is awarded to the lowest bidder. Private-funded projects have more flexibility in evaluating the tender proposal. Private owners may adopt the competitive bidding system, or the owner may select a specific contractor and negotiate the contract terms. Negotiated contract systems have flexibility of pricing arrangement as well as the selection of the contractor based on his expertise or the owner's past experience with the contractor

TABLE 4.9

Contract Documents

Document No. (I) Tendering Procedures Consisting of the Following	
I.1	Tendering Invitation
I.2	Instructions for Tenderers
I.3	Form of Tender and Appendix
I.4	Initial Bond (Form of Bank Guarantee)
I.5	Performance Bond (Form of Bank Guarantee)
I.6	Form of Agreement
I.7	List of Tender Documents
I.8	Declaration No. (1)
Document No. (II) Contract Conditions Consisting of the Following	
II.1	General Conditions (Legal Clauses and Conditions 1971 [May 1985 edition] and amendments until closing date of tender)
II.2	Particular Conditions
II.3	Kuwait Tender Law (Currently valid)
Document No. (III) Technical Conditions and Amendments, Consisting of the Following	
III.1	General Specifications for Building & Engineering Works, Specific to Ministry of Public Works. 1990 edition and all amendments
III.2	Particular Specifications
III.3	Drawings
III.4	Bills of Quantities
III.5	Price Analysis Schedule
III.6	Addenda (if any)
III.7	Technical Requirements (if any), and any other instructions issued by the employer

successfully completing one of his or her projects. The negotiated contract systems are based on following forms of payment:

1. Cost plus contracts: It is a type of contract in which the contractor agrees to do the work for the cost of time and material, plus an agreed upon amount of profit. The following are the different types of cost plus contracts:
 - a. Cost plus percentage fee contract
 - b. Cost plus fixed fee contract
 - c. Cost plus incentive fee contract
2. Reimbursement contracts: It is a type of contract in which the contractor agrees to do the work for the cost per schedule of rates, or bill of quantities, or bill of material.
3. Fixed price contracts: With this type of contract, the contractor agrees to work with a fixed price (it is also called *lump sum*) for the specified and contracted work. Any extra work is executed only upon receipt of instruction from the owner. Fixed price contracts are generally inappropriate for work involving major uncertainties, such as work involving new technologies.
4. Target cost contracts: A target cost contract is based on the concept of a top-down approach, which provides a fixed price for an agreed range of out-turn costs around the target. In this type of contract, overrun or underspend are shared by the owner and the contractor at predetermined agreed-upon percentages.
5. Guaranteed maximum price contracts (cost plus guaranteed maximum price): With this type of contract, the owner and contractor agree to a project cost guaranteed by the contractor as maximum.

It is the owner's desire that his or her facility be of good quality and the price reasonable. In order to achieve this, the owner has to share risks and/or provide incentives and safeguards to enhance the quality of construction. The risk involved in various types of contracts based on forms of payment is as follows:

1. Cost plus—high risk
2. Reimbursement—intermediate
3. Fixed price—low risk

In order to maintain a climate of mutual cooperation during construction, the owner has to develop an understanding with the contractor. The contract needs to be adapted through mutual agreement with the contractor. The contract strategy needs to provide incentives and safeguards to deal with the risks.

Turner (2003) has suggested a twofold methodology in contract selection. The aim is

1. To develop a cooperative project organization
2. To appropriately allocate resources

Turner (2003) has further described that, per Oliver Williamson (1995, 1996), there are two schemas or vectors to describe the ability of contracts to provide ex-ante incentivization and flexible, farsighted ex-post governance. The first schema has three parameters:

- The reward it provides the contractor to share the owner’s objectives and perform
- The associated risk
- The safeguard provided by the owner through contract to shield the contractor from the risk

Figure 4.28 illustrates a sample contractual schema for ex-ante incentivization. Although the schema in Figure 4.28 assumes a safeguard risk, it can deal with only a risk that is foreseen. Williamson has further proposed four parameters to describe the ability of a contract form to provide flexible, farsighted, ex-post governance:

1. The incentive intensity
2. The ease of making uncontested, bilateral adaptations to contract

Risk	Present	High incentive	Medium incentive
	Absent	Low incentive	No safeguard or incentive necessary
		Absent	Present
Safeguard			

FIGURE 4.28 A sample contractual schema for ex-ante incentivization. (From J.R. Turner, *Contracting for Project Management*, 2003. Reprinted with permission from Ashgate Publishing Limited.)

Contract form	Reward	Risk	Safeguard
Cost plus			
cost +%fee	High but misaligned	High	High
cost+ fixed fee	Medium but misaligned	High	High
cost + incentive fee	Medium	High	High
alliance	Medium	High	Medium
Remeasurement			
r-sor	Low and misaligned	Low	High
r-boq	Low	Medium	Medium
r-bom	Low	Medium	Low
Fixed price			
build only	Low	Low	Low
specification a	Low	Low	Low
specification b	Medium	Medium	Low
cardinal points	High	High	Low (insurance)
Other			
target price	Medium	Medium	Medium
time and materials	High	High	Low
budget or gmp			
Routine contracts			
market	High	Low	Low
hierarchy	Low	High	High

FIGURE 4.29

Contract forms and ex-ante incentivization. r = remeasurement based; sor = schedule of rates; boq = bill of quantities; bom = bill of materials. (From J.R. Turner, *Contracting for Project Management*, 2003. Reprinted with permission from Ashgate Publishing Limited.)

3. The reliance on monitoring and related administrative controls (transaction costs)
4. The reliance on court ordering

The incentive profiles of the contract types are summarized in Figure 4.29, and the governance profiles in Figure 4.30.

In the case of a competitive bidding system, it is necessary that the detailed design and specifications for the project be prepared by the designer for bidding purposes. Under the competitive bidding system, normally there are four stages in tendering of a construction project:

1. Selection of tenderer (prequalification)
2. Invitation to bid
3. Tender preparation and submission
4. Appraisal of tenders, negotiation, and decision

Contract Form	Incentive Intensity	Adaptiveness	Transaction Cost	Safeguard
Cost plus				
cost +%fee	Misaligned	High	High	Low
cost+ fixed fee	Low	High	High	Low
cost + incentive fee	Medium	High	High	Low
alliance	High	High	High	Low
Remeasurement				
r-sor	Misaligned	Medium	High	Low
r-boq	Low	Medium	Medium	Low
r-bom	Low	Medium	Low	Low
Fixed price				
build only	Low	Low	High	High
specification a	Low	Low	High	High
specification b	Medium	Medium	Medium	Medium
cardinal points	High	High	Low	Low
Other				
target price	Medium	Low	High	Medium
time and materials	Low	Low	High	High
budget or gmp				
Routine contracts				
market	High	Low	Low	High
hierarchy	Low	High	High	Low

FIGURE 4.30

Contract forms and flexible, farsighted, ex-post governance. r = remeasurement based; sor = schedule of rates; boq = bill of quantities; bom = bill of materials. (From J.R. Turner, *Contracting for Project Management*, 2003. Reprinted with permission from Ashgate Publishing Limited.)

For most construction projects, selection of a tenderer is based on the lowest tender price. Tenders received are opened and evaluated by the owner/owner's representative. Normally, tender results are declared in the official gazette or by some sort of notifications. The successful tenderer is informed of the acceptance of the proposal and is invited to sign the contract. The tenderer has to submit the performance bond before the formal contract agreement is signed. If a successful tenderer fails to submit the performance bond within the specified period or withdraws his tender, then the contractor loses the initial bond and may be subjected to other regulatory applicable conditions.

The signing of contract agreement between the owner/owner's representative and the contractor binds both parties to fulfill their contractual obligations.

4.5 Construction

Construction is the translation of the owner's goals and objectives into a facility built by the contractor as stipulated in the contract documents, plans,

and specifications within budget and on schedule. The construction phase is an important phase in construction projects. A majority of total project budget and schedule is expended during construction. Similar to costs, the time required for the construction phase of the project is much higher than the time required for the preceding phases. Construction usually requires a large workforce and a variety of activities. Construction activities involve erection, installation, or construction of any part of the project. Construction activities are actually carried out by the contractor's own workforce or by subcontractors. Construction therefore requires more detailed attention of its planning, organizations, monitoring and control of project schedule, budget, quality, safety, and environment concerns.

Oberlender (2000) has described the importance of construction in the following words:

The construction phase is important because the quality of the completed project is highly dependent on the workmanship and management of construction. The quality of construction depends on the completeness and quality of the contract documents that are prepared by the designer and three other factors: laborers who have the skills necessary to produce the work, field supervisors who have the ability to coordinate the numerous activities that are required to construct the project in the field, and the quality of materials that are used for construction of project. Skilled laborers and effective management of the skilled laborers are both required to achieve a quality project. (p. 258)

It is usual to invite contractors to compete for a contract for construction work, in the expectation that they will plan to do the work efficiently and therefore at a minimum cost. Once the contract is awarded to the successful bidder (contractor), it is the responsibility of the contractor to respond to the needs of the client (owner) by building the facility as specified in the contract documents, drawings, and specifications within the budget and on time.

The owner also appoints an engineer to supervise the construction process. It is a normal practice for the designer/consultant of the project to be contracted by the owner to supervise the construction process. The engineer is responsible for achieving project quality goals and is also responsible for implementing the procedures specified in the contract documents. Table 4.10 lists the responsibilities the owner delegates to the engineer.

Sometimes the owner engages a construction manager or project manager during the construction process to act as the owner's representative and delegates the following activities, thus leaving the engineer to perform project quality-related work only:

1. Review of contract documents
2. Approval of contractor's construction schedule
3. Cost control

TABLE 4.10

Responsibilities of Supervision Consultant

Serial No.	Description
1	Achieving the quality goal as specified
2	Review contract drawings and resolve technical discrepancies/errors in the contract documents
3	Review construction methodology
4	Approval of contractor's construction schedule
5	Regular inspection and checking of executed works
6	Review and approval of construction materials
7	Review and approval of shop drawings
8	Inspection of construction material
9	Monitoring and controlling construction expenditure
10	Monitoring and controlling construction time
11	Maintaining project record
12	Conduct progress and technical co-ordination meetings
13	Coordination of Owner's requirements and comments related to site activities
14	Project-related communication with contractor
15	Coordination with regulatory authorities
16	Processing of site work instruction for the owner's action
17	Evaluation and processing of variation order/change order
18	Recommendation of contractor's payment to owner
19	Evaluating and making decisions related to unforeseen conditions
20	Monitor safety at site
21	Supervise testing, commissioning, and handover of the project
22	Issue substantial completion certificate

4. Time control

5. Project methodology

The engineer appoints an engineer's representative to supervise the project construction process. The engineer's representative is supported by a supervision team consisting of professionals having experience and expertise in supervision and administration of similar construction projects. The engineer's representative is also called the resident engineer. Depending on the type and size of the project, the supervision team usually consists of the following personnel:

1. Resident engineer
2. Contract administrator/quantity surveyor
3. Planning/scheduling engineer
4. Engineers from different trades such as architectural, structural, mechanical, HVAC, electrical, low voltage system, landscape, infrastructure

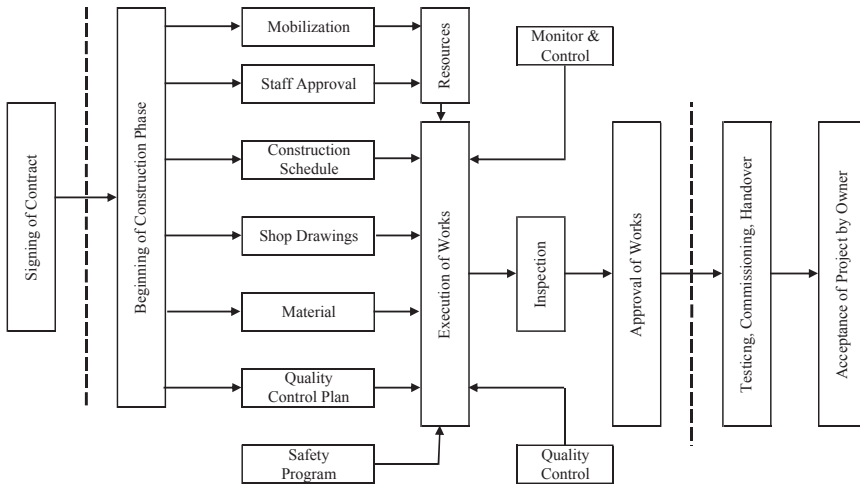

FIGURE 4.31

Major activities during the construction phase.

5. Inspectors from different trades
6. Interior designer
7. Document controller
8. Office secretary

The construction phase consists of various activities such as mobilization, execution of work, planning and scheduling, control and monitoring, management of resources/procurement, quality, and inspection. Figure 4.31 illustrates major activities to be performed during the construction phase.

These activities are performed by various parties having contractual responsibilities to complete the specified work. Coordination among these parties is essential to ensure that the constructed facility meets the owner's objectives.

4.5.1 Mobilization

The contractor is given a few weeks to start the construction work after the signing of the contract. The activities to be performed during the mobilization period are defined in the contract documents. During this period, the contractor is required to perform many of the activities before the beginning of actual construction work at the site. Necessary permits are obtained from the relevant authorities to start the construction work. After being granted access to the construction site by the owner, the contractor starts mobilization work, which consists of preparation of site offices/field offices for the owner,

supervision team (consultant), and for the contractor himself. This includes all the necessary on-site facilities and services necessary to carry out specific tasks. Mobilization activities usually occur at the beginning of a project but can occur anytime during a project when specific on-site facilities are required.

Examples of mobilization activities include

- Set up site offices and storage
- Construct temporary access roads, lay down areas and perimeter fences
- Install the necessary utilities for construction
- Set up a temporary firefighting system
- Perform site survey and testing
- Satisfy health and site safety requirements
- Submit preliminary construction program
- Selection of core staff as mentioned in the contract documents
- Insurance policies
- Selection of subcontractor (this may be an ongoing activity per the approved schedule)

In anticipation of the award of contract, the contractor begins the following activities much in advance, but these are part of contract documents, and the contractor's action is required immediately after signing of the contract in order to start construction:

- Mobilization of construction equipment and tools
- Workforce to execute the project

For a smooth flow of construction process activities, proper communication and submittal procedure need to be established among all concerned parties at the beginning of the construction activities. Table 4.11 illustrates an example matrix for site administration of a building construction project.

Proper adherence to these duties helps smooth implementation of the project. Correspondence between consultant and contractor is normally through letters or job site instructions. Figure 4.32 is a job site instruction form used by the consultant to communicate with the contractor.

4.5.2 Execution of Works

According to the authors of *Civil Engineering Procedure* (Institution of Civil Engineers 1996):

The contractor is responsible for construction and maintaining the works in accordance with the contract drawings, specifications and other

TABLE 4.11

Matrix for Site Administration and Communication

Serial No.	Description of Activities	Contractor	Consultant	Owner
1	Communication			
	1.1 General Correspondence	P	P	P
	1.2 Job Site Instruction	D	P	C
	1.3 Site Works Instruction	D	P/B	A
	1.4 Request for Information	P	A	C
	1.5 Request for Modification	P	B	A
2	Submittals			
	2.1 Subcontractor	P	B/R	A
	2.2 Materials	P	A	C
	2.3 Shop Drawings	P	A	C
	2.4 Staff Approval	P	B	A
	2.5 Pre-meeting Submittals	P	D	C
3	Plans and Programs			
	3.1 Construction Schedule	P	R	C
	3.2 Submittal Logs	P	R	C
	3.3 Procurement Logs	P	R	C
	3.4 Schedule Update	P	R	C
4	Monitor and Control			
	4.1 Progress	D	P	C
	4.2 Time	D	P	C
	4.3 Payments	P	R/B	A
	4.4 Variations	P	R/B	A
	4.5 Claims	P	R/B	A
5	Quality			
	5.1 Quality Control Plan	P	R	C
	5.2 Checklists	P	D	C
	5.3 Method Statements	P	A	C
	5.4 Mock up	P	A	B
	5.5 Samples	P	A	B
	5.6 Remedial Notes	D	P	C
	5.7 Nonconformance Report	D	P	C
	5.8 Inspections	P	D	C
	5.9 Testing	P	A	B
6	Site Safety			
	6.1 Safety Program	P	A	C
	6.2 Accident Report	P	R	C

(Continued)

TABLE 4.11 (Continued)

Matrix for Site Administration and Communication

Serial No.	Description of Activities	Contractor	Consultant	Owner
7	Meetings			
	7.1 Progress	E	P	E
	7.2 Coordination	E	P	C
	7.3 Technical	E	P	C
	7.4 Quality	P	C	C
	7.5 Safety	P	C	C
	7.6 Closeout		P	
8	Reports			
	8.1 Daily Report	P	R	C
	8.2 Monthly Report	P	R	C
	8.3 Progress Report		P	A
	8.4 Progress Photographs		P	A
9	Close Out			
	9.1 Snag List	P	P	C
	9.2 Authorities' Approvals	P	C	C
	9.3 As-Built Drawings	P	D/A	C
	9.4 Spare Parts	P	A	C
	9.5 Manuals and Documents	P	R/B	A
	9.6 Warranties	P	R/B	A
	9.7 Training	P	C	A
	9.8 Handover	P	B	A
	9.9 Substantial Completion Certificate	P	B/P	A

P-Prepare/Initiate**B-Advise/Assist****R-Review/Comment****A-Approve****D-Action****E-Attend****C-Information**

documents and also further information and instruction issued in accordance with the contract. The contractor should be as free as possible to plan and execute the works in the way he wishes within the terms of his contract, so should the sub-contractors. Any requirements for part of a project to be finished before the rest and all limits of contractor's freedom should therefore have been stated in the tender document. (p. 77)

Construction activities mainly consist of the following:

- Site work such as cleaning and excavation of project site
- Construction of foundations, including footings and grade beams
- Construction of columns and beams

Project Name Consultant Name
--

JOB SITE INSTRUCTION (JSI)

CONTRACTOR: _____ JSI No. : _____

CONTRACT No.: _____ DATE : _____

The work shall be carried out in accordance with the Contract Documents without change in Contract Sum or Contract Time. Proceeding with the work in accordance with these instructions indicates your acknowledgement that there will be no change in the Contract Sum or Contract Time.

Subject:

SAMPLE FORM

ATTACHMENTS: (List attached documents that support description.)

Signed: _____
Resident Engineer

Received by Contractor : _____
Date: _____

Distribution: Owner A/E Contractor

FIGURE 4.32
Job site instruction.

- Forming, reinforcing, and placing of the floor slab
- Laying up masonry walls and partitions
- Installation of roofing system
- Finishes
- Furnishings

- Conveying system
- Installation of firefighting system
- Installation of water supply, plumbing, and public health system
- Installation of heating, ventilation, and air-conditioning system
- Integrated automation system
- Installation of electrical lighting and power system
- Emergency power supply system
- Fire alarm system
- Communication system
- Electronic security and access control system
- Landscape works
- External works

4.5.3 Planning and Scheduling

Project planning is a logical process to ensure that the work of the project is carried out

- In an organized and structured manner
- Reducing uncertainties to a minimum
- Reducing risk to a minimum
- Establishing quality standards
- Achieving results within budget and scheduled time

Prior to the start of execution of a project or immediately after the actual project starts, the contractor prepares the project construction plans based on the contracted time schedule of the project. Detailed planning is needed at the start of construction to decide how to use resources such as laborers, plant, materials, finance, and subcontractors economically and safely to achieve the specified objectives. The plan shows the periods for all sections of the works and activities, indicating that everything can be completed by the date specified in the contract and ready for use or for installation of equipment by other contractors.

According to Oberlender (2000), "Project Planning is the heart of good project management because it provides the central communication that coordinates the work of all parties. Planning also establishes the benchmark for the project control system to track the quantity, cost, and timing of work required to successfully complete the project. Although the most common desired result of planning is to finish the project on time, there are other benefits that can be derived from good project planning" (p. 140).

Effective project management requires planning, measuring, evaluating, forecasting, and controlling all aspects of project quality and quality of work, cost, and schedules. The purpose of the project plan is to successfully control

TABLE 4.12**Benefits of Project Planning and Scheduling**

-
1. Finish the project on time.
 2. Continuous (uninterrupted) flow of work (no delays).
 3. Reduced amount of rework (least amount of changes).
 4. Minimize confusion and misunderstandings.
 5. Increased knowledge of status of project by everyone.
 6. Meaningful and timely reports to management.
 7. You run the project instead of the project running you.
 8. Knowledge of scheduled times of key parts of the project.
 9. Knowledge of distribution of costs of the project.
 10. Accountability of people, defined responsibility/authority.
 11. Clear understanding of who does what, and how much.
 12. Integration of all work to ensure a quality project for the owner.
-

Source: Oberlender, G.D. (2000). *Project Management for Engineering*.
Reprinted with permission of The McGraw-Hill Companies.

the project to ensure completion within the budget and schedule constraints. Project planning is the evolution of the time and efforts to complete the project. Table 4.12 lists the benefits of project planning and scheduling.

Planning is a mechanism that conveys or communicates to project participants what activity is to be done, how, and in what order to meet the project objectives by scheduling the activities. Project planning is required to bring the project to completion on schedule, within budget, and in accordance with the owner's needs as specified in the contract. The planning process considers all the individual tasks, activities, or jobs that make up the project and must be performed. It takes into account all the resources available, such as human resources, finances, materials, plant, equipment, etc. It also considers the works to be executed by the subcontractors.

The following is the list of activities of construction projects normally included in the construction program/plan:

A. General Activities

1. Mobilization

B. Engineering

1. Subcontractor submittal and approval
2. Materials submittal and approval
3. Shop drawing submittal and approval
4. Procurement

C. Site Activities

1. Site earthworks
2. Dewatering and shoring

3. Excavation and backfilling
4. Raft works
5. Retaining wall works
6. Concrete foundation and grade beams
7. Waterproofing
8. Concrete columns and beams
9. Casting of slabs
10. Wall partitioning
11. Interior finishes
12. Furnishings
13. External finishes
14. Equipment
15. Conveying systems works
16. Plumbing and public health works
17. Firefighting works
18. HVAC works
19. Electrical works
20. Fire alarm system works
21. Communication system works
22. Low voltage systems works
23. Landscape works
24. External works

D. Close Out

1. Testing and commissioning
2. Completion and handover

The contractor also submits the following:

1. Resources (equipment and manpower) schedule
2. Cost loading (schedule of item's pricing based on bill of quantities)

Planning and scheduling are often used synonymously for preparing a construction program because both are performed interactively. Planning is the process of identifying the activities necessary to complete the project, while scheduling is the process of determining the sequential order of the planned activities and the time required to complete the activity. Scheduling is the mechanical process of formalizing the planned functions, assigning the starting and completion dates to each part or activity of the work in such a manner that the whole work proceeds in a logical sequence and in an orderly and systematic manner.

The first step in preparation of a construction program is to establish the activities, and the next step is to establish the estimated time duration of each activity. The deadline for each activity is fixed, but it is often possible to reschedule by changing the sequence in which the tasks are performed, while retaining the original estimated time. Figure 4.33 illustrates the steps in project planning.

Construction projects are unique and nonrepetitive in nature. Construction projects consist of many activities aimed at the accomplishment of a desired objective. In order to achieve the quality objectives of the project, each activity has to be completed within the specified limit, using the specified product and approved method of installation. A construction project consists of a number of related activities that are dependent on other activities and cannot be started until others are completed, and some that can run in parallel. The most important point while starting the planning is to establish all the activities that constitute the project. Table 4.13 lists key principles for planning and scheduling.

Planning involves defining the objectives of the project; listing of tasks or jobs that must be performed; determining gross requirements for material, equipment, and manpower; and preparing costs and durations for the various jobs or activities needed for the satisfactory completion of the project. The techniques for planning vary depending on the project's size, complexity, duration, personnel, and owner's requirements. Techniques used during the construction phase of the project should make possible the evaluation of the project's progress against the plan. There are many different analytical and graphical techniques that are commonly used for planning of the project. These are

1. The bar chart
2. Critical path method (CPM)
3. Progress curves
4. Matrix schedule

The most widely used forms of program are bar charts and network diagrams. The bar chart is the oldest planning method used in project management. It is a graphical representation of the estimated duration of each activity and the planned sequence of activities. The horizontal axis represents the time schedule, whereas the project activities are shown along the vertical axis.

Network diagrams such as program evaluation and review technique (PERT) and CPM are used for scheduling of complex projects. PERT/CPM diagrams consist of nodes and links and represent the entire project as a network of arrows (activities) and nodes (events). In order to draw a network diagram, work activities have to be identified, the relationships among the activities need to be specified, and a precedence relationship between the activities in a particular sequence needs to be established.

The most widely used scheduling technique is CPM. CPM analysis represents the set of sequence of predecessor/successor activities that will

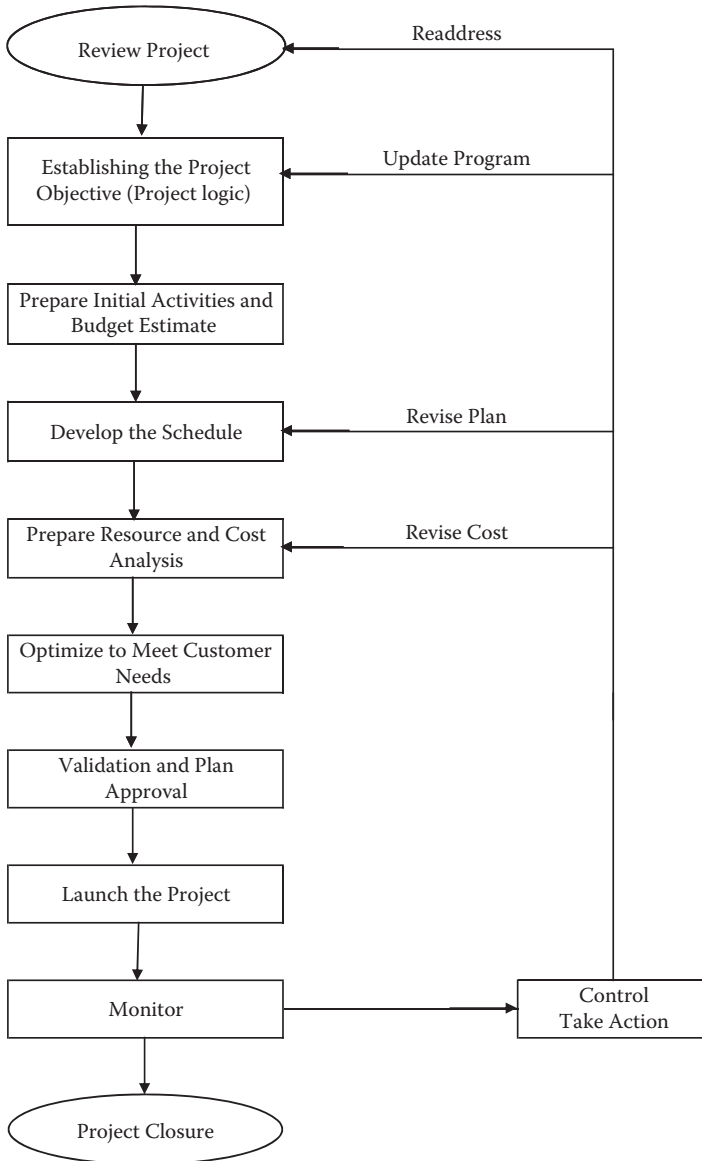

FIGURE 4.33
Project planning steps.

TABLE 4.13**Key Principles for Planning and Scheduling**

-
1. Begin planning before starting work, rather than after starting work
 2. Involve people who will actually do the work in the planning and scheduling process
 3. Include all aspects of the project: scope, budget, schedule, and quality
 4. Build flexibility into the plan, include allowance for changes and time for reviews and approvals
 5. Remember the schedule is the plan for doing the work, and it will never be precisely correct
 6. Keep the plan simple, eliminate irrelevant details that prevent the plan from being readable
 7. Communicate the plan to parties; any plan is worthless unless it is known
-

Source: Oberlender, G.D. (2000). *Project Management for Engineering*. Reprinted with permission of The McGraw-Hill Companies.

take the longest time to complete. The duration of the critical path is the sum of all the activity durations along the path. Thus, the critical path is the longest possible path of the project activities network. The duration of the critical path represents the minimum time required to complete the project.

There are many computer-based programs available for preparing the network and critical path of activities for construction projects. These programs can be used to analyze the use of resources, review project progress, and forecast the effects of changes in the schedule of works or other resources. Most computer programs automate preparation and presentation of various planning tools such as the bar chart, PERT, and CPM analysis. These programs are capable of storing enormous quantities of data and help process and update the program quickly. They manipulate data for multiple usages from the planning and scheduling perspectives.

In order to manage and control the project at different levels in the most effective manner, it is broken down into a group of smaller subprojects/subsystems and then into small, well-defined activities. This breakdown is necessary because of the size and complexity of construction projects, and is referred to as work breakdown structure (WBS). To begin the preparation of the detailed construction program, the contractor prepares a WBS. Its purpose is to define various activities that must be executed to complete the project. WBS helps the construction project planner to

1. Plan and schedule the work
2. Estimate costs and budget
3. Control schedule, cost, and quality

Activities are those operations of the plan that take time to carry out and on which resources are expended. Depending on the size of the project, the project is divided into multiple zones, and relevant activities are considered

for each zone to prepare the construction program. Appendix B illustrates an example guideline listing major activities performed during building construction projects and are commonly used by the contractor's scheduler/planner to prepare the contractor's construction schedule/program. Electromechanical activities are further divided into first fix, second fix, and final fix, depending on their relationship with civil and architectural works. The construction program is prepared by selecting appropriate activities relevant to a particular floor/zone. These activities are also considered for preparation of cost and resource loading schedule for the project. While preparing the program, the relationships between project activities and their dependency and precedence are considered by the planner. These activities are connected to their predecessor and successor activity based on the way the task is planned to be executed. There are four possible relationships that exist between various activities. These are the finish-to-start relationship, the start-to-start relationship, the finish-to-finish relationship, and the start-to-finish relationship.

In order to prepare a project plan the logic is reviewed for correctness and ascertained that all activities are shown, the scope of the project has been interpreted correctly, and the resources that are required for performing each job are applied. Figure 4.34 illustrates a logic flowchart for firefighting works. Similarly, Figures 4.35 through 4.37 illustrate logic flowcharts for plumbing, HVAC, and electrical works, respectively.

Once all the activities are established by the planner and the estimated duration of each activity has been assigned, the planner prepares a detailed program fully coordinating all the construction activities.

CPM calculates the minimum completion time for a project along with the possible start and finish times for the project activities. The critical path is the longest in the network, whereas the other paths may be equal or shorter than that path. Therefore, there is a possibility that some of the events and activities can be completed before they are actually needed and, accordingly, it is possible to develop a number of activity schedules from the CPM analysis to delay the start of each activity as long as possible but still finish the project with minimum possible time without extending the completion date of the project. To develop such a schedule, it is required to find out when each activity needs to start and when it needs to be finished. There may be some activities in the project with some leeway for when they can start and finish. This is called slack time, or float, in an activity. For each activity in a project, there are four points in time: early start, early finish, late start, and late finish. Early start and early finish are the earliest times an activity can start and finish, respectively. Similarly, late start and late finish are the latest times an activity can start and finish, respectively. The difference between late start time and early start time is the slack time, or float.

With the advent of powerful computer programs such as Primavera® and Microsoft Project™, it is possible for the details of the work breakdown to be fed to these software programs. The software is capable of producing

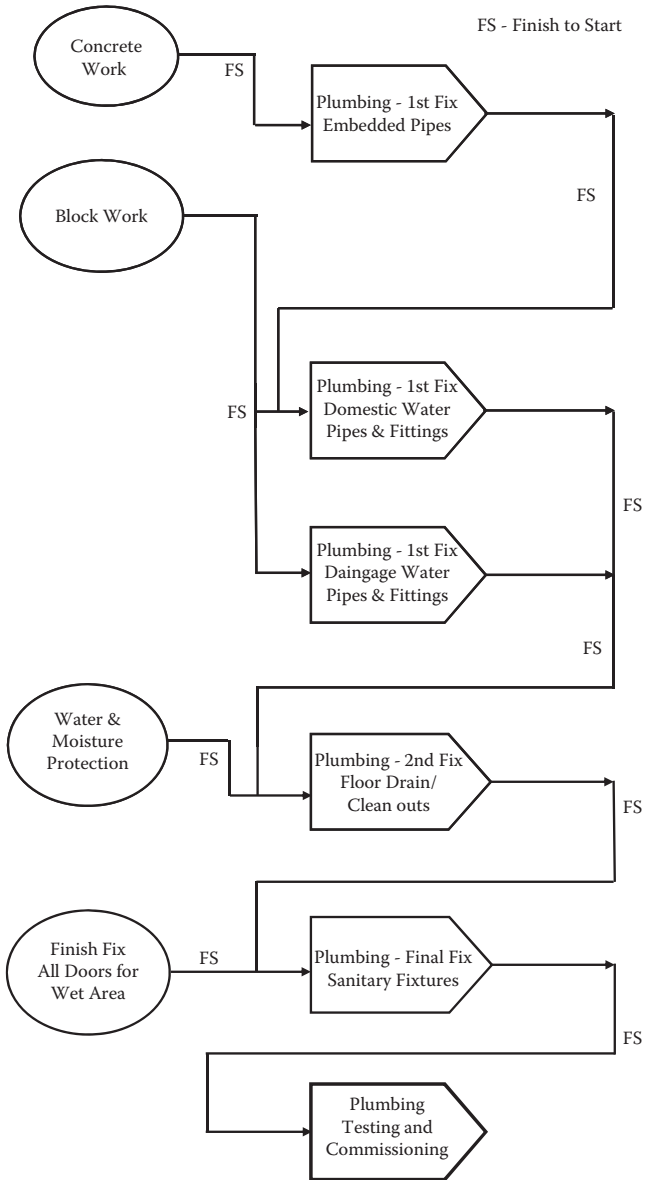

FIGURE 4.35
Logic flowchart for plumbing work.

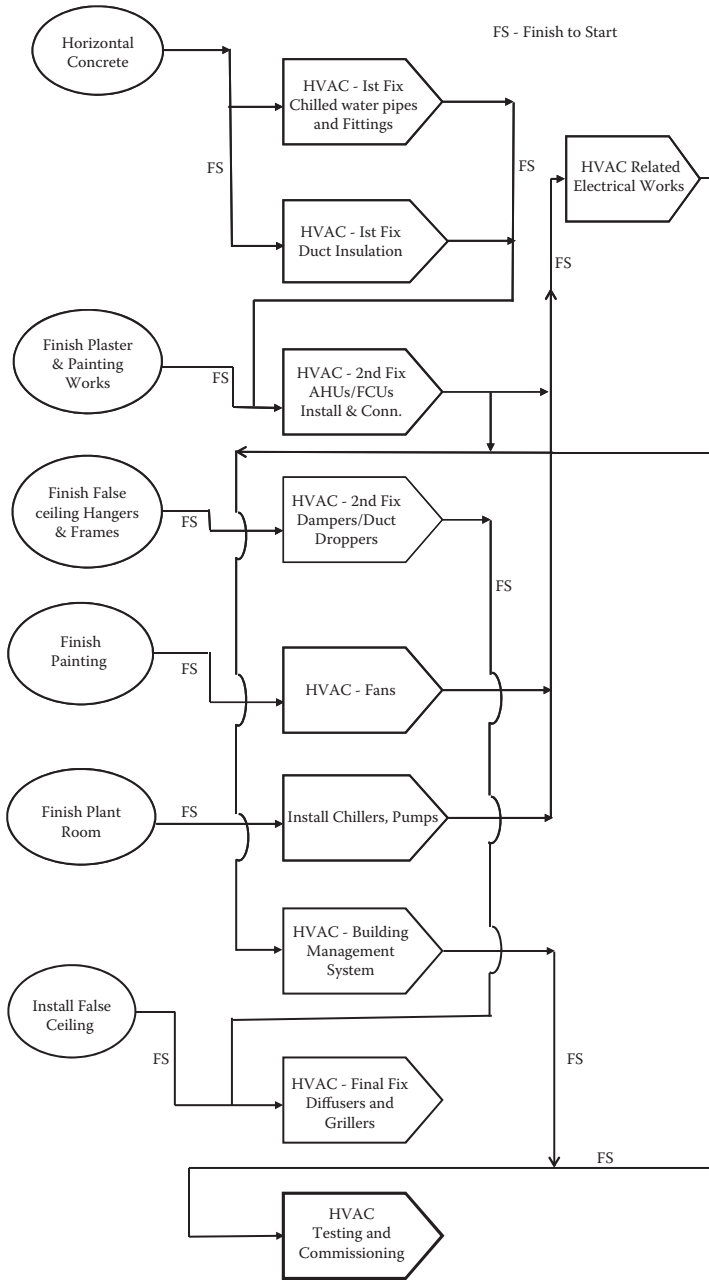

FIGURE 4.36 Logic flowchart for HVAC work.

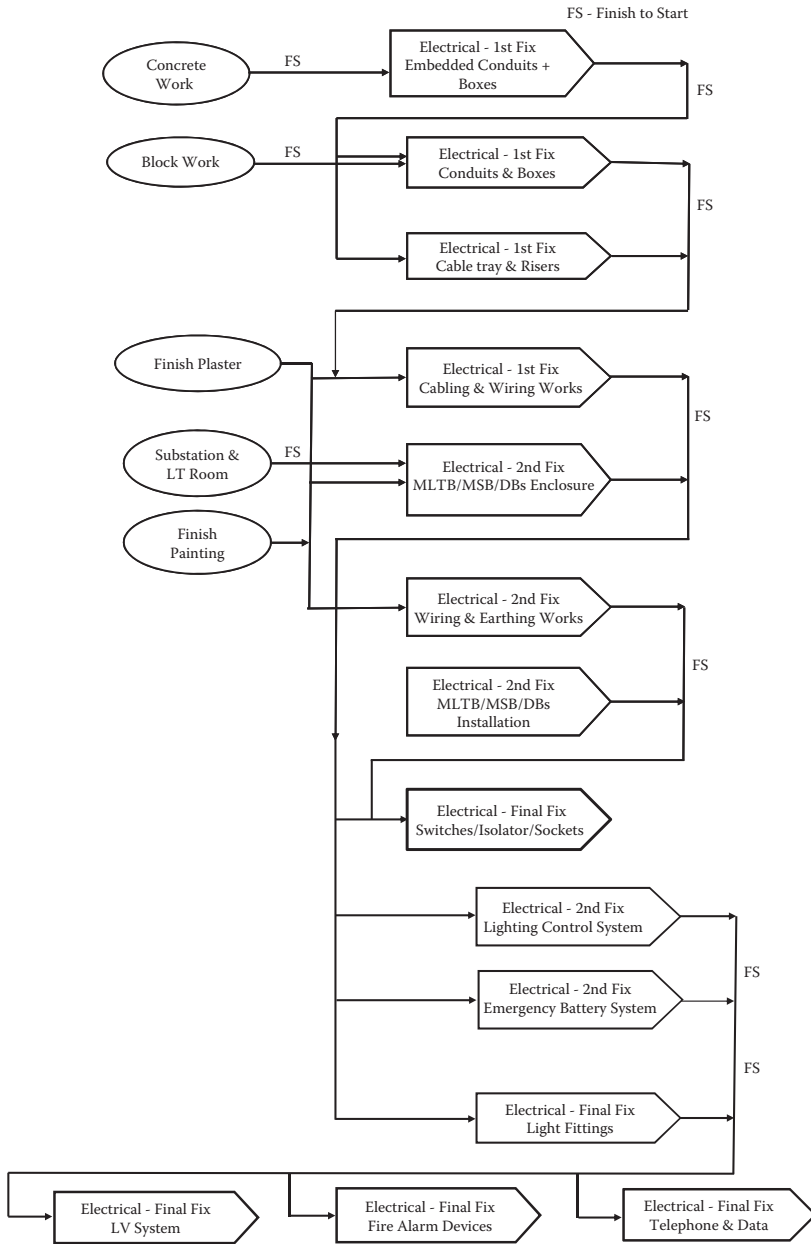

FIGURE 4.37
Logic flowchart for electrical work.

network diagrams and schedules and a limitless number of different reports, which also help in the efficient monitoring the project schedule by comparing actual with planned progress. The software can be used to analyze the project for use of resources, forecasting the effects of changes in the schedule, and cost control. Figure 4.38 illustrates an example construction program summary of a smart building system project for an office building.

4.5.4 Management Resources/Procurement

In most construction projects, the contractor is responsible for engaging sub-contractors, specialist installers, and suppliers; and arranging for materials, equipment, construction tools, and all types of human resources needed to complete the project per contract documents and to the satisfaction of the owner or the owner's appointed supervision team. Workmanship is one of the most important factors to achieve quality in construction; therefore, it is required that the construction workforce be fully trained and have full knowledge of all the related activities to be performed during the construction process.

Once the contract is awarded, the contractor prepares a detailed plan for all the resources he or she needs to complete the project. The contractor also prepares a procurement log based on the project completion schedule.

Contract documents normally specify a list of the minimum number of core staff to be available on site during the construction period. The absence of any of these staff may result in a penalty being imposed on the contractor by the owner.

The following is a typical list of a contractor's minimum core staff needed during the construction period for execution of the work of a major building construction project:

1. Project manager
2. Site senior engineer for civil works
3. Site senior engineer for architectural works
4. Site senior engineer for electrical works
5. Site senior engineer for mechanical works
6. Site senior engineer for HVAC works
7. Site senior engineer for infrastructure works
8. Planning engineer
9. Senior quantity surveyor/contract administrator
10. Civil works foreman
11. Architectural works foreman
12. Electrical works foreman
13. Mechanical works foreman
14. HVAC works foreman

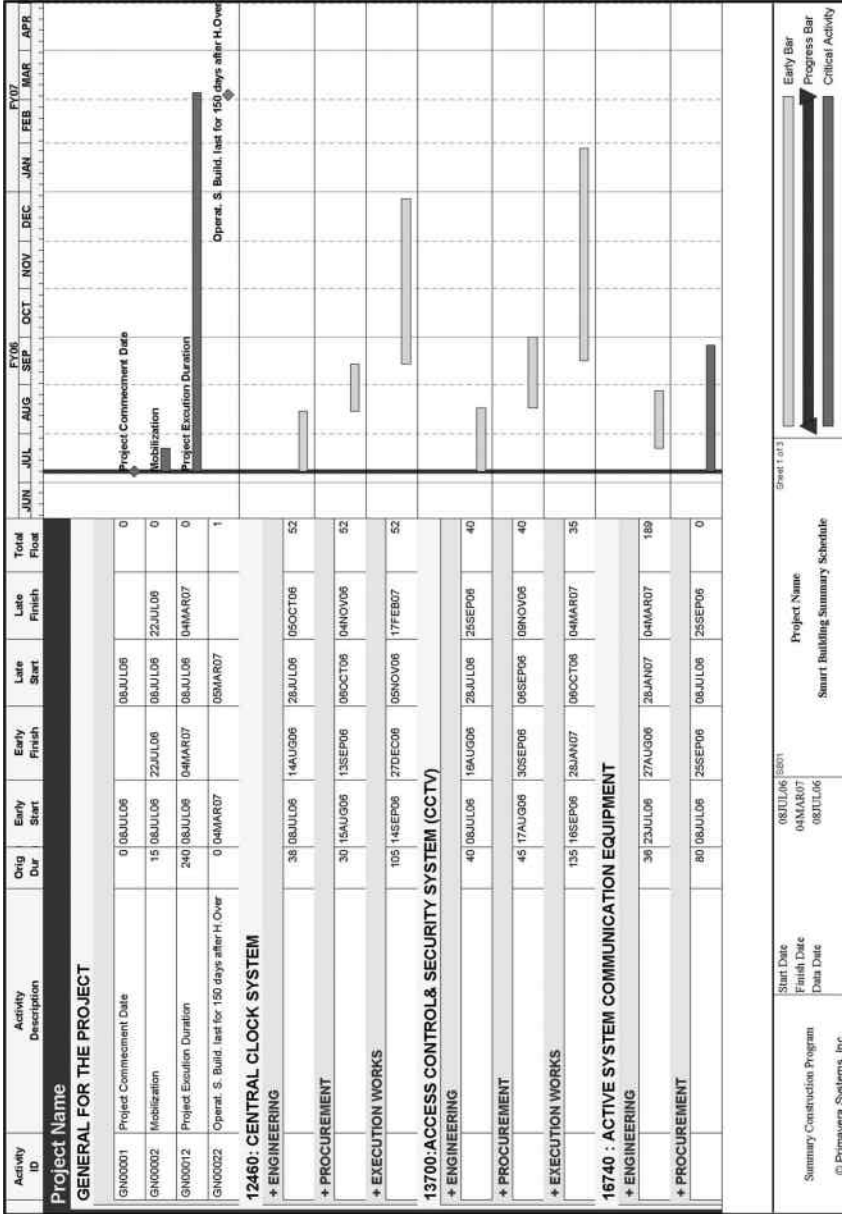

FIGURE 4.38

15. Laboratory technician
16. Quality control engineer
17. Safety officer

The contractor has to submit the names of the staff for these positions for approval from the owner/consultant to work on the project. Figure 4.39 illustrates a staff approval request form used by the contractor to propose the staff to work for these positions and is submitted along with the qualification and experience certificates of the proposed staff.

The contractor's human resources mainly fall into two categories:

1. The contractor's own staff and workers
2. The subcontractor's staff and workers

The main contractor has to manage all these personnel by

1. Assigning daily activities
2. Observing their performance and work output
3. Daily attendance
4. Safety during the construction process

Figure 4.40 illustrates the contractor's manpower chart of a construction project.

Likewise, the contract documents specify that a minimum equipment set is to be available on site during the construction process to ensure smooth operation of all the construction activities. These are

- Tower crane
- Mobile crane
- Normal mixture
- Concrete mixing plant
- Dump trucks
- Compressor
- Vibrators
- Water pumps
- Compactors
- Concrete pumps
- Trucks
- Concrete trucks
- Diesel generator sets

Project Name	
Consultant Name	
REQUEST FOR SITE STAFF APPROVAL	
CONTRACT NO. :	NO. :
CONTRACTOR :	DATE:

SAMPLE FORM

To : Owner

1. Name	:	<hr/>
2. Profession	:	<hr/>
3. Position No. in Document-I	:	<hr/>
4. No. of years of Experience	:	<hr/>
5. Membership of Professional Body	:	Valid <input type="checkbox"/> Not Valid <input type="checkbox"/>
6. Requested Date of Commencement	:	<hr/>
7. Remarks	:	<hr/>
<hr style="width: 30%; margin: 0 auto;"/> Signature Contractor's Project Manager		
OWNER COMMENTS		APPROVED <input type="checkbox"/> NOT APPROVED <input type="checkbox"/>
<hr style="width: 30%; margin: 0 auto;"/> Owner Rep. Signature		<hr style="width: 30%; margin: 0 auto;"/> Date

Distribution OWNER A/E CONTRACTOR

FIGURE 4.39
Request for staff approval.

Figure 4.41 illustrates the equipment schedule, which lists the equipment the contractor has to make available for major building construction projects.

In most construction projects, the contractor is responsible for procurement of material, equipment, and systems to be installed on the project. Contractors have their own procurement strategies. While submitting the bid, the contractor obtains quotations from various suppliers/subcontractors. The contractor has to consider the following, at a minimum, while finalizing the procurement:

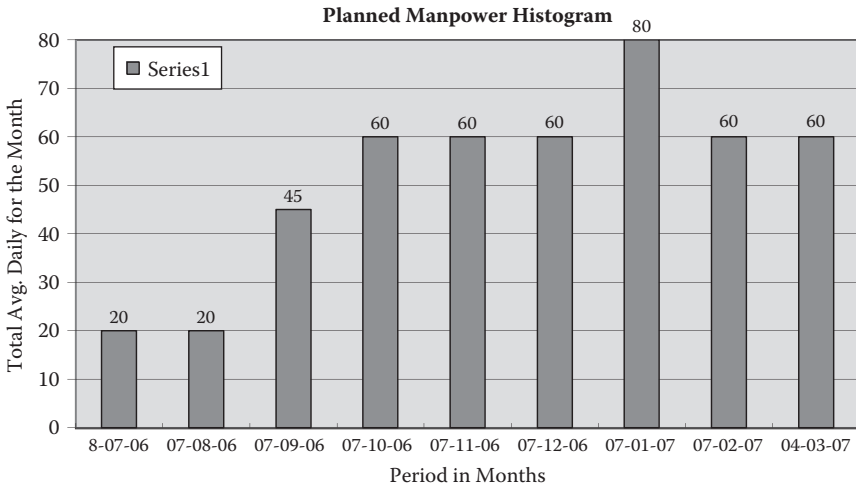

FIGURE 4.40
Manpower plan.

- Contractual commitment
- Specification compliance
- Statutory obligations
- Time
- Cost
- Performance

Figure 4.42 illustrates the material approval and procurement procedure to be followed by the contractor.

4.5.5 Monitoring and Control

Once planning and scheduling are complete and the project is under way, progress on the project must be monitored on an ongoing basis to ensure that the goals and objectives on the project are being met. Monitoring and control of a construction project are necessary during the execution of the project, and its aim is to recognize any obstacles encountered during execution and to apply measures to mitigate these difficulties.

Monitoring is collecting, recording, and reporting information concerning any and all aspects of project performance that the project manager or others in the organization need to know. Monitoring of construction projects is normally done by collecting and recording the status of various activities and compiling them in the form of a progress report. These are prepared by the consultant or contractor and distributed to the concerned members of the project team. Table 4.14 shows the content of a progress report prepared by the consultant's team.

Project Name
Consultant Name

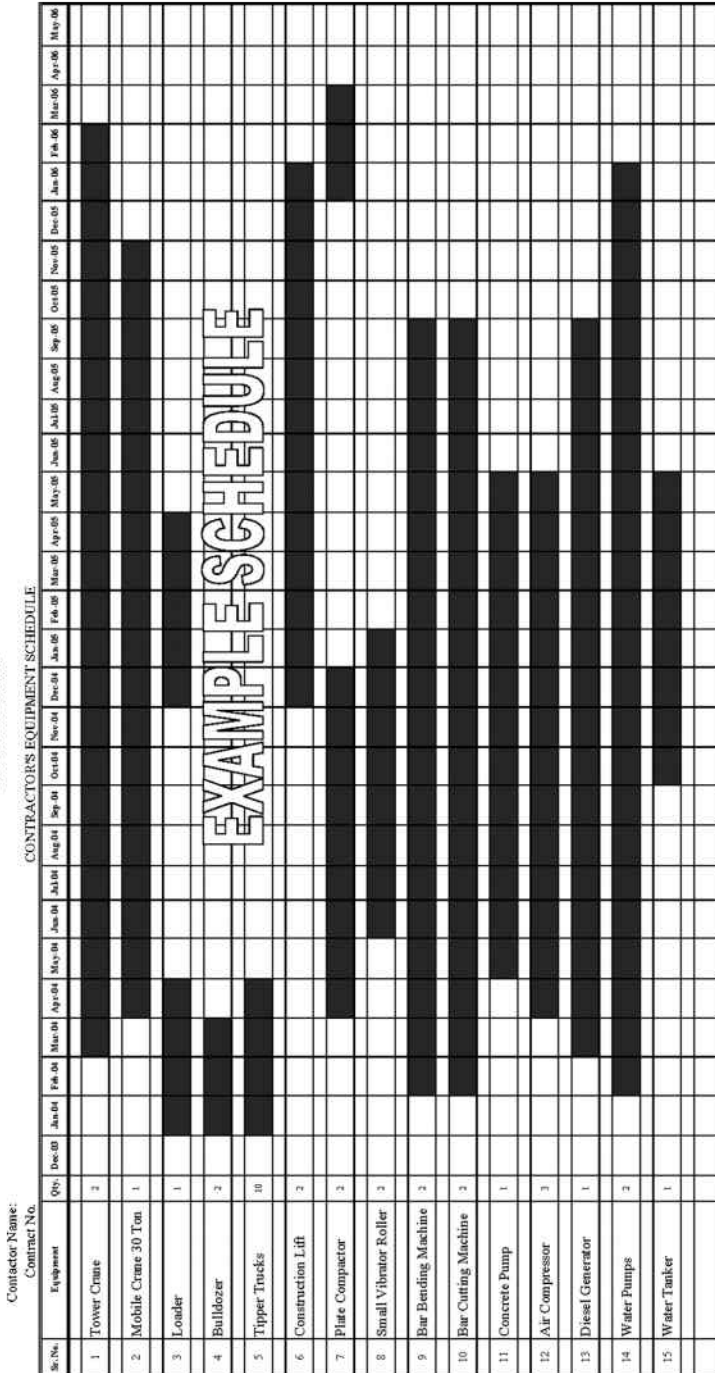

FIGURE 4.41
Equipment schedule.

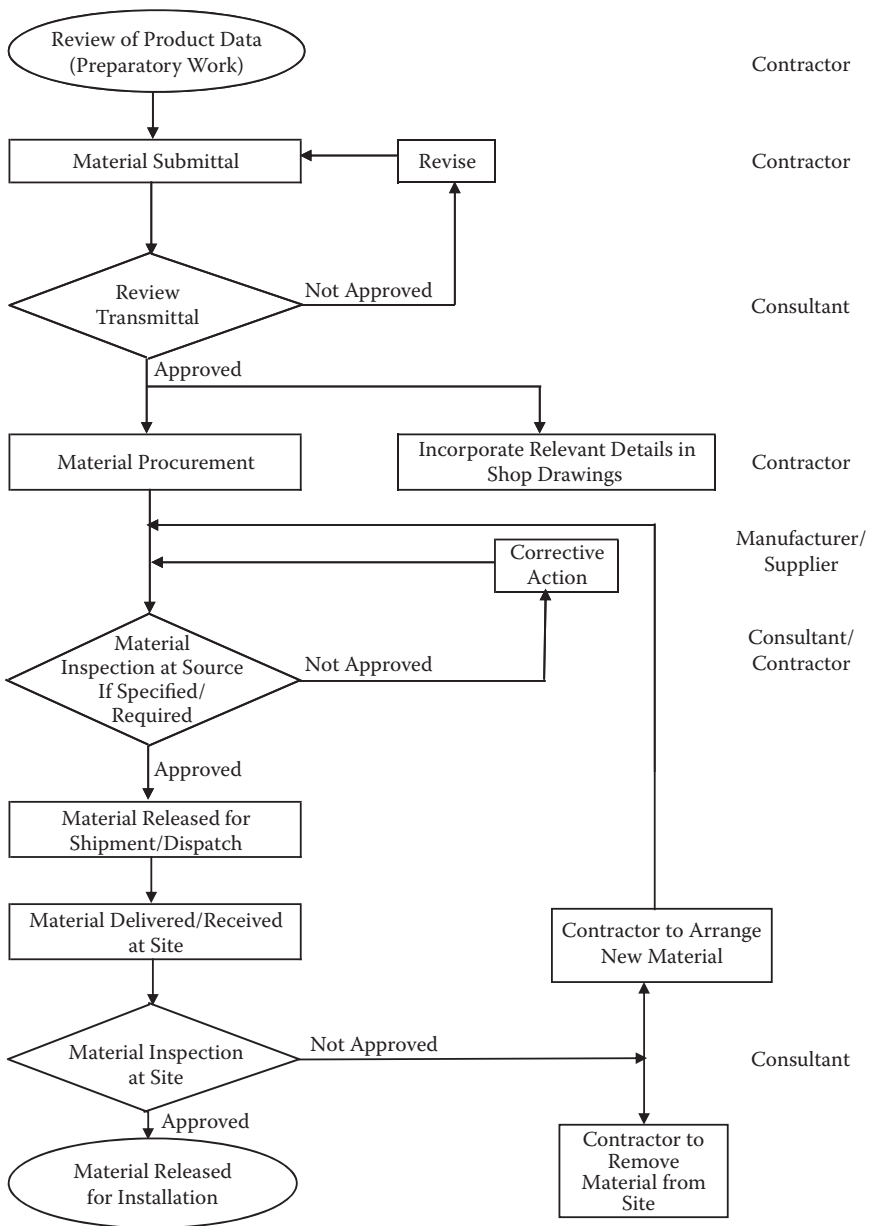

FIGURE 4.42
Material approval and procurement procedure.

TABLE 4.14**Contents of Progress Report**

- 1.0 Contract Particulars
 - 1.1 Project Description
 - 1.2 Project Data
 - 2.0 Construction Schedule
 - 3.0 Progress of Works
 - 3.1 Temporary Facilities and Mobilization
 - 3.2 Summary of Construction Progress
 - 3.2.1 Status
 - 3.2.2 On-Shore Progress
 - 3.2.3 Off-Shore Progress
 - 4.0 Time Control
 - 4.1 CPM Schedule-Level One (Target vs. Current) —
Summary by Building/Marine
 - 4.2 CPM Schedule-Level Two (Target vs. Current) —
Summary by Building/Division
 - 4.3 30 Days Look-Ahead Schedule
 - 4.4 Time Control Conclusion
 - 5.0 Cost Control
 - 5.1 Financial Progress
 - 5.2 Cash Flow Curve and Histogram
 - 5.3 Work-in-Place S-Curve and Histogram
 - 5.4 Cost Control Conclusion
 - 6.0 Status of Contractor's Submittals
 - 6.1 Material Status
 - 6.2 Shop Drawing Status
 - 7.0 Subcontractors
 - 8.0 Consultant's Staff
 - 9.0 Quality Control
 - 10.0 Meetings
 - 11.0 Site Work Instructions
 - 12.0 Variation Orders
 - 13.0 Construction Photographs
 - 14.0 Contractors Resources
 - 15.0 Other Matters
 - 15.1 Safety
 - 15.2 Weather Conditions
 - 15.3 Important Developments/Proposals/Submissions
-

Monitoring involves not only tracking time but also resources and budget. Monitoring in construction projects is normally done by compiling the status of various activities in the form of progress reports. These are prepared by the contractor, supervision team (consultant), and construction/project management team. The objectives of project monitoring and control are to

1. Report the necessary information in detail and in an appropriate form that can be interpreted by management and other concerned personnel to provide them with information about how the resources are being used to achieve project objectives
2. Provide an organized and efficient means of measuring, collecting, verifying, and quantifying data reflecting the progress and status of execution of project activities, with respect to schedule, cost, resources, procurement, and quality
3. Provide an organized, efficient, and accurate means of converting the data from the execution process into information
4. Identify and isolate the most important and critical information about the project activities to enable decision-making personnel to take corrective action for the benefit of the project
5. Forecast and predict the future progress of activities to be performed

Once the scheduled plan has been prepared and execution has commenced, control over progress of work has to be exercised to ensure completion of the work by the stipulated time. A project control mechanism can be used to determine deviations from the basic plan, the precise effect of these deviations on the plan, and to replan and reschedule to compensate for the deviations.

Based on the progress of work and the revised durations of unfinished activities due to delays, the network diagram is replanned and rescheduled; this process is known as updating. If the completion date is beyond the milestone dates, then the contractor is required to submit a recovery plan to compensate for the delay in execution of the project. Project control involves a regular comparison of performance against targets, a search for the cause of deviation, and a commitment to check adverse variance. It serves two major functions:

1. It ensures regular monitoring of performance.
2. It motivates project personnel to strive for achieving project objectives.

Construction projects have certain specific checkpoints or events where an evaluation is made to see that the project is on time and to ensure that project objectives are met. These significant events are termed *milestones*. A milestone

is a point in time that marks the start or finish of a significant activity or group of activities, usually the completion of a major deliverable, for example, completion of concrete works, receipt of major equipment, completion of testing, etc. The milestone points are determined at the beginning of the project. Milestone evaluation is used to certify that all the work scheduled to be accomplished has been completed according to the specification requirements.

According to CII Source Document 61 (1990):

Project control is frequently referenced in the literature as a highly problematic area of project management. It is concerned with scope control, timely decision making, control system integration, control techniques, and key estimating practices. One attribute of successful project control is a sound baseline (or plan) from which to compare actual performance. This baseline for the cost control component is the budget estimate. (p. 78)

A construction project control is exercised through knowing where to put in the main effort at a given time and maintaining good communication. There are mainly three areas where project control is required: (1) budget, (2) schedule, and (3) quality.

In most contracts, the cost and time required to complete the specified scope of works are defined in project documents. Control is thus a matter of reporting and regular progressing of project activities against fixed targets. Control of quality of materials and workmanship is achieved through a proper quality control plan and its implementation through a preset level of quality control, and inspection of various activities and materials.

Budget control is done through monitoring progress payments and variation costs.

The schedule is monitored by ensuring timely approval of materials, shop drawings, timely procurement of materials, and execution of works as planned.

Quality control is achieved through inspection of works during the construction process, ensuring the use of approved materials and workmanship.

There are different types of logs used in a construction project for monitoring purposes. The main logs used in a construction project are as follows.

4.5.5.1 Subcontractors Submittal and Approval Log

In most construction projects, the contractor engages special subcontractors to execute certain portions of the contracted project work. Areas of subcontracting are generally listed in the particular conditions of the contract document. Generally, the contractor has to submit subcontractors/specialist contractors to execute the following type of works:

1. Precast concrete works
2. Metal works

3. Space frame, roofing works
4. Wood works
5. Aluminum works
6. Internal finishes such as painting, false ceiling, tiling, cladding
7. Furnishings
8. Waterproofing and insulation works
9. Mechanical works
10. HVAC works
11. Electrical works
12. Low voltage systems/smart building system
13. Landscape
14. External works
15. Any other specialized works

The contractor has to submit their names for approval to the owner prior to their engagement to perform any work at the site. The names of subcontractors for various subprojects have to be submitted for approval in a timely and orderly manner, as planned in the approved work program, so that work progresses in a smooth and efficient manner. This log helps remind the project manager to ask the main contractor to submit the subcontractors on time.

Figure 4.43 is a request for subcontractor approval to be submitted by the contractor for getting approval of any subcontractor proposed to work on the construction project.

The request includes all the related information to prove the subcontractor's capability of providing services that meet the required project quality, the resources available to meet the specified schedule, and past performance; also, if any quality system was implemented by the subcontractor, that fact is noted.

Sometimes, the owner/consultant nominates subcontractors to execute a portion of a contract; such a subcontractor is known as a nominated subcontractor.

4.5.5.2 Shop Drawings and Materials Logs—E1

The timely submission and approval of shop drawings and materials is a must for the smooth and efficient progress of any project. The project manager and the consultant team constantly monitor these logs on a biweekly basis. The bottlenecks are identified, and technical meetings are held to solve the problems.

Figure 4.44 illustrates a submittal status log form normally called Log E-1 that is submitted by the contractor to the construction manager/project manager/consultant.

Figure 4.45 illustrates a shop drawing status log.

These logs are based on the approved construction program.

Project Name		
Contract No.:		
Contractor :		
CONTRACTOR REQUEST FOR SUB-CONTRACTOR APPROVAL		
		Serial No.:
Kindly approve the following as a SUB-CONTRACTOR in the above mentioned Project		
	Sub-Contract Works	_____
	Sub-Contractor	_____
	Address (Head Office)	_____
	Reference Letter	_____
Attachments:	SAMPLE FORM	
	Commercial Register	_____
	Experience	_____
	Current Work	_____
	Others (List, if any)	_____
	Foundation Contract	_____
	Resources	_____
	Financial Status	_____
.....		
.....		
.....		
Performance Bond (Yes/No)	_____	No. _____
Signed by		
Contractor's Representative	_____	Date:
OWNER'S NAME		
Received by: _____	Signature : _____	Date:
SITE SUPERVISION CONSULTANT		
Received by: _____	Signature : _____	Date:
Consultant's recommendation : _____		
.....		
.....		
.....		
.....		
.....		
Signed by		
Resident Engineer	_____	Date:
Distribution :	OWNER(Original)	Supervision Consultant (Copy)
		Contractor (Copy)
Note : Contractor shall submit Original to OWNER with copy to Site Supervision Consultant.		

FIGURE 4.43
Request for subcontractor approval.

Project Name																	
Consultant Name																	
CONTRACTOR'S SUBMITTAL STATUS LOG (REPORT E-1)																	
CONTRACT NO. :										NO. :							
CONTRACTOR :										DATE :							
Document Specification or BOQ Page	Submittal Sequence No.	Rev	Description	Date of Submittal												Action Code: A = Approved as submitted B = Approved as noted C = Not Approved D = For Information	Remarks
				Month	Year	Day	Time	Planned Sub. Date	Submitted By	Reviewed By	Action	Approved/Noted By	Expired On Job				
				MO	YR	DT	TR	MT	CT	TT	OT						
SAMPLE FORM																	

FIGURE 4.44 Contractor's submittal status log.

Project Name																	
Consultant Name																	
CONTRACTOR'S SHOP DRAWINGS STATUS LOG																	
CONTRACT NO. :										NO. :							
CONTRACTOR :										DATE :							
Document Specification or BOQ Page	Item No.	Submittal Sequence No.			Drawing No.	Description	Submittal Type	Action Code: A = Approved as submitted B = Approved as noted C = Approved as noted, Revoked D = Not Approved E = For Information					Remarks				
		Dis	Yes	Typ No.				Rev	3	Planned Sub. Date	Submitted By	Reviewed By		Action	Approved/Noted By	Expired On Job	
SAMPLE FORM																	

FIGURE 4.45 Contractor's shop drawing status log.

		Project Name																												Total					
Contractor Name		Consultant Name																																	
Contract No.		CONTRACTOR'S EQUIPMENT STATUS																																	
No.	Equipment	1	2	3	4	5	6	7	8	9	10	11	12	13	14	15	16	17	18	19	20	21	22	23	24	25	26	27	28	29	30	31	32		
1	Tower Crane	1	1	1	1	1	1	1	1	1	1	1	1	1	1	1	1	1	1	1	1	1	1	1	1	1	1	1	1	1	1	1	1		
2	Mobile Crane 30 Ton	1	1	1	1	1	1	1	1	1	1	1	1	1	1	1	1	1	1	1	1	1	1	1	1	1	1	1	1	1	1	1	1		
3	Excavator	1	1	1	1	1	1	1	1	1	1	1	1	1	1	1	1	1	1	1	1	1	1	1	1	1	1	1	1	1	1	1	1		
4	ICB Back Hoe	1	1	1	1	1	1	1	1	1	1	1	1	1	1	1	1	1	1	1	1	1	1	1	1	1	1	1	1	1	1	1	1		
5	Loader	1	1	1	1	1	1	1	1	1	1	1	1	1	1	1	1	1	1	1	1	1	1	1	1	1	1	1	1	1	1	1	1		
6	Tractor	1	1	1	1	1	1	1	1	1	1	1	1	1	1	1	1	1	1	1	1	1	1	1	1	1	1	1	1	1	1	1	1		
7	Water Tanker	1	1	1	1	1	1	1	1	1	1	1	1	1	1	1	1	1	1	1	1	1	1	1	1	1	1	1	1	1	1	1	1		
8	Tipper /Tractor	1	1	1	1	1	1	1	1	1	1	1	1	1	1	1	1	1	1	1	1	1	1	1	1	1	1	1	1	1	1	1	1		
9	Trailer	1	1	1	1	1	1	1	1	1	1	1	1	1	1	1	1	1	1	1	1	1	1	1	1	1	1	1	1	1	1	1	1	1	
10	Drill Crane	1	1	1	1	1	1	1	1	1	1	1	1	1	1	1	1	1	1	1	1	1	1	1	1	1	1	1	1	1	1	1	1	1	
11	Construction Lift	1	1	1	1	1	1	1	1	1	1	1	1	1	1	1	1	1	1	1	1	1	1	1	1	1	1	1	1	1	1	1	1	1	
12	Concrete Pump	1	1	1	1	1	1	1	1	1	1	1	1	1	1	1	1	1	1	1	1	1	1	1	1	1	1	1	1	1	1	1	1	1	
13	Concrete Vibrator	1	1	1	1	1	1	1	1	1	1	1	1	1	1	1	1	1	1	1	1	1	1	1	1	1	1	1	1	1	1	1	1	1	
14	Concrete Mixer	1	1	1	1	1	1	1	1	1	1	1	1	1	1	1	1	1	1	1	1	1	1	1	1	1	1	1	1	1	1	1	1	1	1
15	Bulk Cut	1	1	1	1	1	1	1	1	1	1	1	1	1	1	1	1	1	1	1	1	1	1	1	1	1	1	1	1	1	1	1	1	1	1
16	Fork Lift	1	1	1	1	1	1	1	1	1	1	1	1	1	1	1	1	1	1	1	1	1	1	1	1	1	1	1	1	1	1	1	1	1	1
17	Bar Bending Machine	1	1	1	1	1	1	1	1	1	1	1	1	1	1	1	1	1	1	1	1	1	1	1	1	1	1	1	1	1	1	1	1	1	1
18	Bar Cutting Machine	1	1	1	1	1	1	1	1	1	1	1	1	1	1	1	1	1	1	1	1	1	1	1	1	1	1	1	1	1	1	1	1	1	1
19	Jack Hammer	1	1	1	1	1	1	1	1	1	1	1	1	1	1	1	1	1	1	1	1	1	1	1	1	1	1	1	1	1	1	1	1	1	1
20	Anchor Machine	1	1	1	1	1	1	1	1	1	1	1	1	1	1	1	1	1	1	1	1	1	1	1	1	1	1	1	1	1	1	1	1	1	1
21	Hammering Machine	1	1	1	1	1	1	1	1	1	1	1	1	1	1	1	1	1	1	1	1	1	1	1	1	1	1	1	1	1	1	1	1	1	1
22	Air Compressor	1	1	1	1	1	1	1	1	1	1	1	1	1	1	1	1	1	1	1	1	1	1	1	1	1	1	1	1	1	1	1	1	1	1
23	Diesel Generator	1	1	1	1	1	1	1	1	1	1	1	1	1	1	1	1	1	1	1	1	1	1	1	1	1	1	1	1	1	1	1	1	1	1
24	Water Pump	1	1	1	1	1	1	1	1	1	1	1	1	1	1	1	1	1	1	1	1	1	1	1	1	1	1	1	1	1	1	1	1	1	1
25	Dewatering Pump	1	1	1	1	1	1	1	1	1	1	1	1	1	1	1	1	1	1	1	1	1	1	1	1	1	1	1	1	1	1	1	1	1	1
26	Ball Lorry	1	1	1	1	1	1	1	1	1	1	1	1	1	1	1	1	1	1	1	1	1	1	1	1	1	1	1	1	1	1	1	1	1	1
27	Tray	1	1	1	1	1	1	1	1	1	1	1	1	1	1	1	1	1	1	1	1	1	1	1	1	1	1	1	1	1	1	1	1	1	1

FIGURE 4.47 Equipment status.

budget. All construction projects track equipment and manpower employed on-site by updating the respective logs.

Figure 4.47 illustrates a list of equipment available on site during a particular month for a major construction project.

Figure 4.48 illustrates a histogram comparing manpower.

These logs provide necessary information about the status of materials, shop drawings, procurement, and availability of contractor’s resources and help determine their effects on project schedule and project completion.

4.5.5.5 Project Payment/Progress Curve (S-Curve)

Monitoring and control of project payment is essential within the budgeted amount. This is done through monitoring cash flow with the help of S-curves and progress curves that give the exact status of payment and also identify if the budget is being exceeded. Uninterrupted cash flow is one of the most important elements in the overall success of the project. Conceptually, cash flow is a simple comparison of when revenue will be received and when the financial obligations must be paid. It is also an indication of the progress of work to be completed in a project. This is obtained by loading each activity in the approved schedule with the budgeted cost in the bill of quantities (BOQ). The process of inputting the schedule of values is known as cost loading. The graphical representation of the foregoing is obtained as a curve and is known as an “S” curve. This also represents the planned progress of a project.

Figure 4.49 illustrates the planned work S-curve.

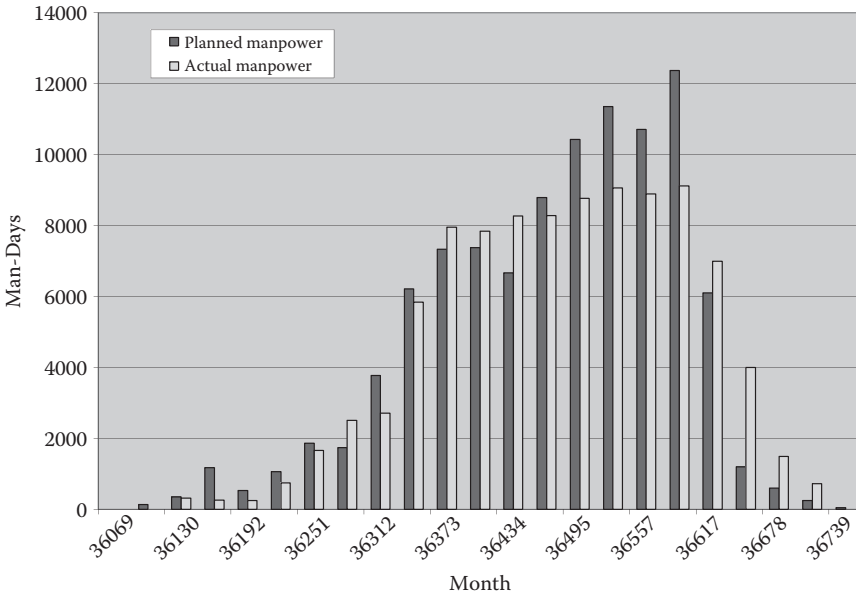

FIGURE 4.48
Manpower comparison histogram.

4.5.5.6 Time Control

Completion of a construction project within the defined schedule is most important. The time control status is prepared in different formats to monitor the project completion time. Figure 4.50 illustrates the project progress status of a building construction project. This chart presents the overall picture of the elapsed period of the project and remaining period of the scheduled project duration, and actual progress versus planned progress.

4.5.5.7 Cash and Time Control

Figure 4.51 illustrates a budget control or work value control chart. This helps to monitor work progress and compare actual work done against planned work.

4.5.5.8 Progress Reports and Meetings

Apart from different types of logs and submittals, progress curves, and time control charts, the contractor's progress is monitored through various types of reports and meetings. The contractor's daily progress is monitored through a daily progress report submitted by the contractor on the morning of the working day following the day to which the report relates. It gives the status of all the resources available on site for that particular day. It shows the details of

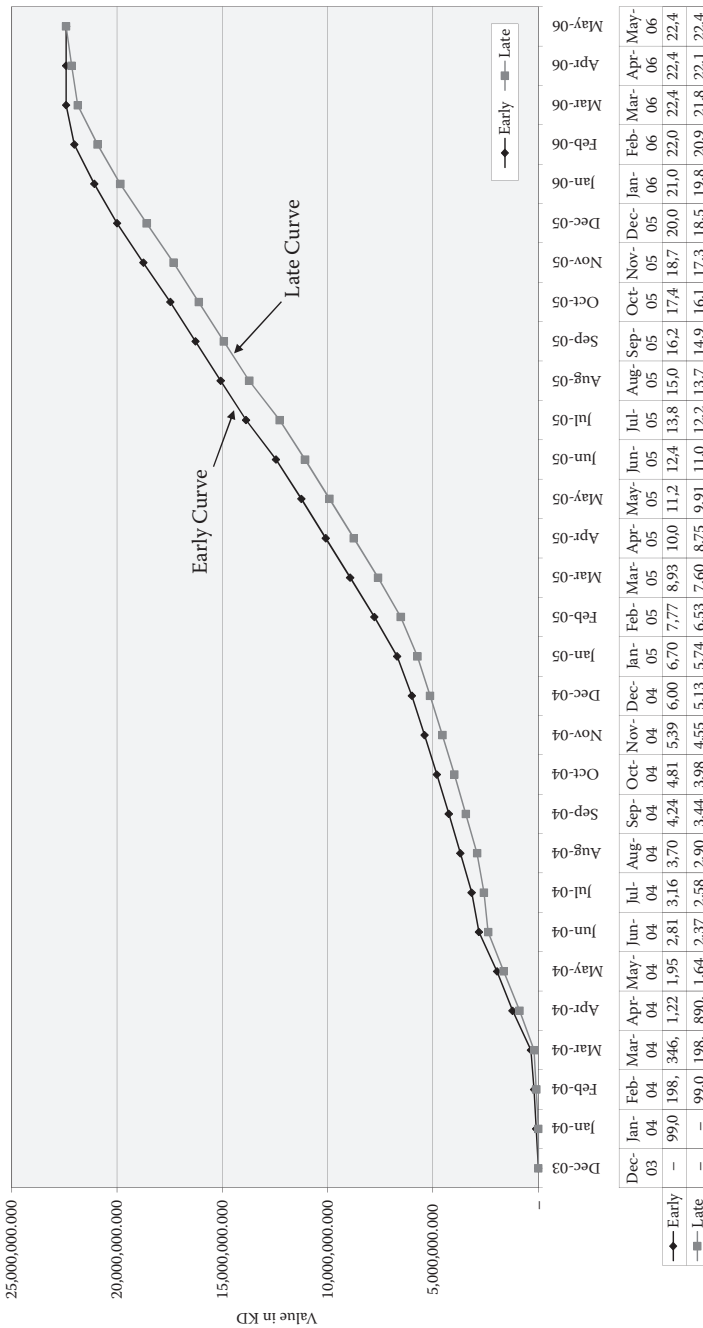

FIGURE 4.49
Planned work S-curve.

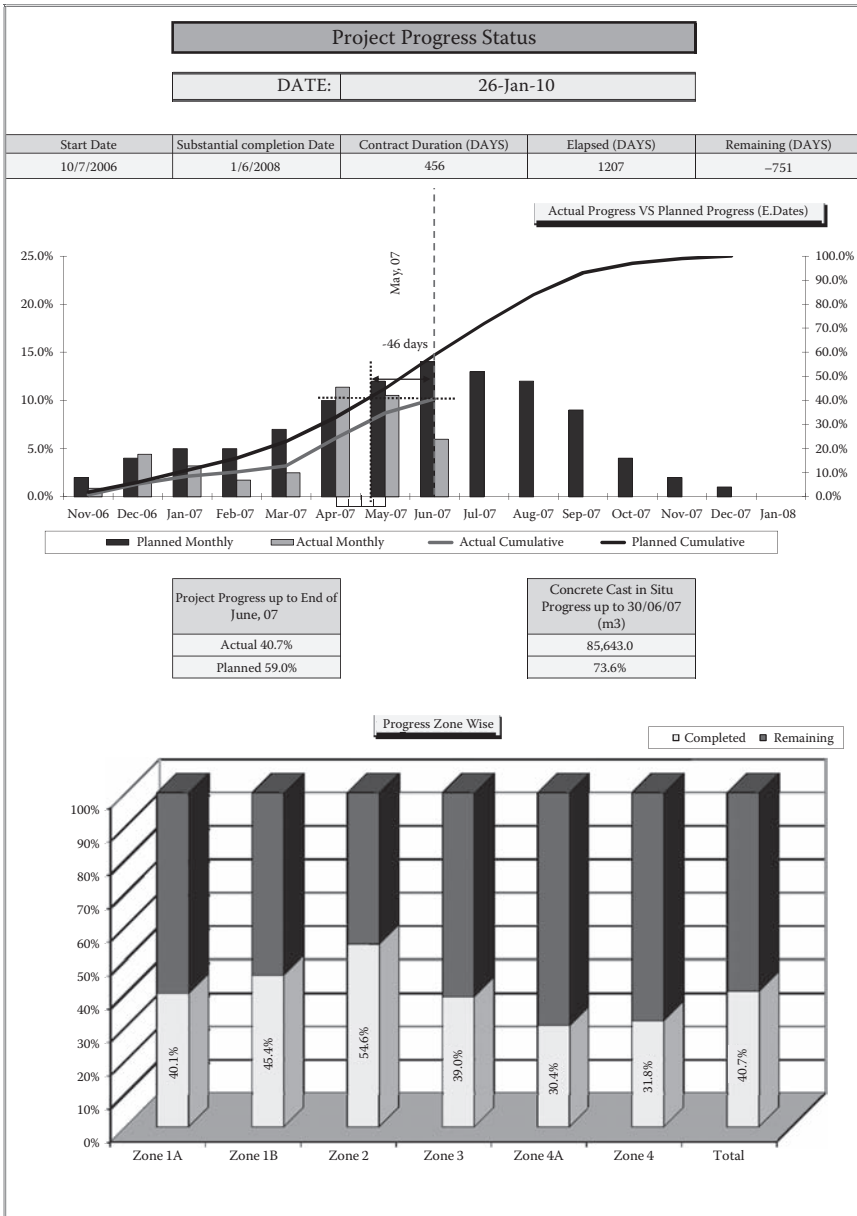

FIGURE 4.50
Project progress status.

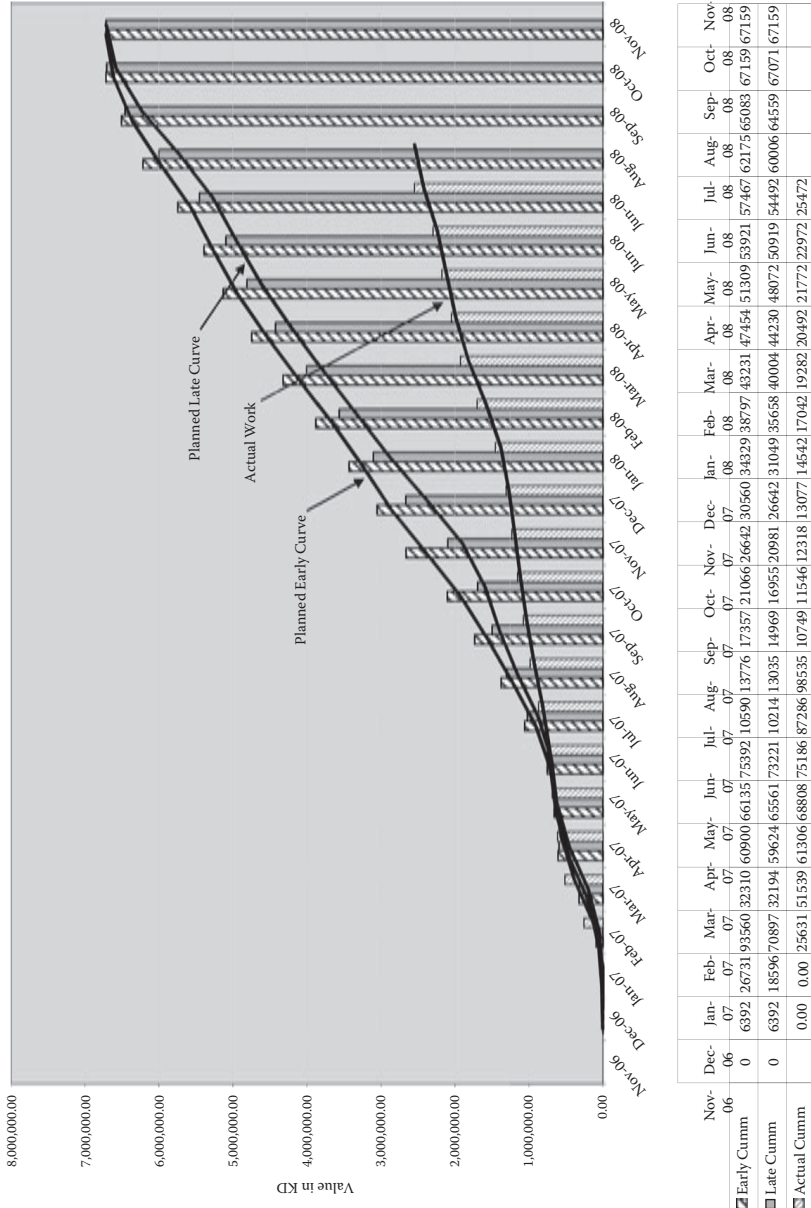

FIGURE 4.51
Comparison between planned versus actual work.

the contractor’s staff and manpower, the contractor’s plant and equipment, and material received at site. Details of the subcontractor’s work and resources are also included in the report. Figure 4.52 illustrates the daily progress report of a building construction project.

Along with the daily report, the contractor submits the work-in-progress report. Figure 4.53 shows this report.

Figure 4.54 shows the checklist status report, which is also to be submitted along with the daily report. This will help the contractor as well as the

Project Name

Consultant Name

CONTRACTOR'S DAILY PROGRESS REPORT

Contract No.:- _____ Contract Day No. _____
 Contractor :- _____ Date _____

SAMPLE FORM

This daily report to be completed on both sides and submitted to the Resident Engineer following the report date.

Contractor's Staff and Manpower Required			Contractor's Staff and Manpower Additional		
Job Description	No.	Actual	Job Description	Skilled	Un-skilled
Contractor's Representative	1		Secretary		
Project Manager	1		Store keeper		
Deputy Project Manager	1		Carpenter		
Planning Manager	1		Steel Bender		
Deputy Planning Manager	1		Concrete workers		
Quality Control Manager	1		Mason		
Quality Control Engineer	1		Plasterer		
Quantity Surveyor	1		Tiler		
Assistant Quantity Surveyor	1		Marble		
Site Engineer (Architect)	2		Ceramic		
Site Civil Engineer	2		Stone		
Site Engr. (Water & Sewerage)	2		Precast		
HVAC Engineer	2		Safety officer		
Mechanical/Fire Fighting Engr.	1		Painter		
Electrical Engineer	2		Plumber		
Communications Engineer	1		HVAC		
Site Engineer (Marine)	1		Fire system		
Site Engr. (Roads & Services)	1		Seaman (Diver)		
Material Engineer	1		Mechanical supervisor		
Assistant Material Engineer	1		Driver		
Landscape Gardener	1		Operator		
Safety Engineer	1		Welder		
Co-ordinator	1		Electrician		
Surveying Engineer	1		Mech. & Elec. Workshop labour		
Surveyor	1		Labour		
Supervisor	4		Others		
Computer Programmer	1				
Computer Draftsman	2				
Draftsman	1				
Laboratory Engineer	1				
Laboratory Technician	1				
	40				

Distribution
 Original : Resident Engineer
 CC : Owner

Contractor.....

FIGURE 4.52
Daily progress report.

5. Technological changes/introduction of new technology
6. Value engineering process
7. Additional work instructed
8. Omission of some work

These changes help build the facility in such a way as to achieve the project objective and are identified as the construction proceeds. Prompt identification of such requirements helps both the owner and contractor avoid unnecessary disruption of work and its impact on cost and time. Figure 4.55 illustrates a request for information form that the contractor submits to the consultant to clarify differences/errors observed in the contract documents, changes in construction methodology, changes in the specified material, etc.

These queries are normally resolved by the concerned supervision engineer. However, it is likely that the matter has to be referred to the designer as request for information (RFI) has many other considerations to take care of that may be beyond the capacity of a supervision team member to resolve. Such queries may result in variation in the contract documents. Figure 4.56 show a flow diagram for processing RFI. It is in the interest of both the owner and contractor to resolve RFI expeditiously to avoid its effect on construction schedule.

Figure 4.57 illustrates a site works instruction (SWI) form. It gives instructions to the contractor to proceed with the changes. All the necessary documents are sent along with the SWI to the contractor. The SWI is also used to instruct the contractor regarding owner-initiated changes.

Figure 4.58 shows a variation order proposal form that the contractor submits to the owner/consultant for approval of changes in the contract.

Similarly, if the contractor requires any modification to the specified method, then he or she submits a request for modification to the owner/consultant. Figure 4.59 shows the request for modification. Usually, these modifications are carried out by the contractor without any extra cost and time obligation toward the contract.

It is normal practice that, for the benefit of project, the engineer's representative assesses the cost and time related to site works instruction (SWI) or request for changeover and obtains preliminary approval from the owner, and the contractor is asked to proceed with such changes. The cost and time implementation is negotiated and formalized simultaneously/ later to issue the formal variation order. In all the circumstances where a change in contract is necessary, owner approval has to be obtained. Figure 4.60 shows the form used by the engineer's representative to obtain change order approval from owner.

Once cost and time implications are negotiated and finalized, and both the owner and contractor approve them, a variation order is issued to the contractor, and changes are adjusted with the contract sum and schedule.

Project Name	
Consultant Name	
REQUEST FOR INFORMATION (TECHNICAL)	
CONTRACT NO. : _____	R.F.I. NO. _____
CONTRACTOR : _____	DATE : _____
To: Resident Engineer _____	
<p>REF:</p> <p>SUBJECT:</p> <p style="text-align: center;"><u>REQUEST FOR INFORMATION (Technical)</u></p> <p style="text-align: center;">This form is used by the contractor to request information and is normally sent to the A/E who responds on the same form.</p> <p style="text-align: center; font-size: 2em; font-weight: bold; letter-spacing: 0.5em;">SAMPLE FORM</p> <p>CONTRACTOR: _____</p> <p>DISTRIBUTION: Employer <input type="checkbox"/> Engineer <input type="checkbox"/> R.E. <input type="checkbox"/></p> <p>RESPONSE BY R.E.:</p> <p>Signature of R. E. _____ Date _____</p> <p>RESPONSE RECEIVED: FOR CONTRACTOR: _____ DATE: _____</p> <p>DISTRIBUTION: Employer <input type="checkbox"/> Engineer <input type="checkbox"/> R.E. <input type="checkbox"/></p>	

FIGURE 4.55
Request for information.

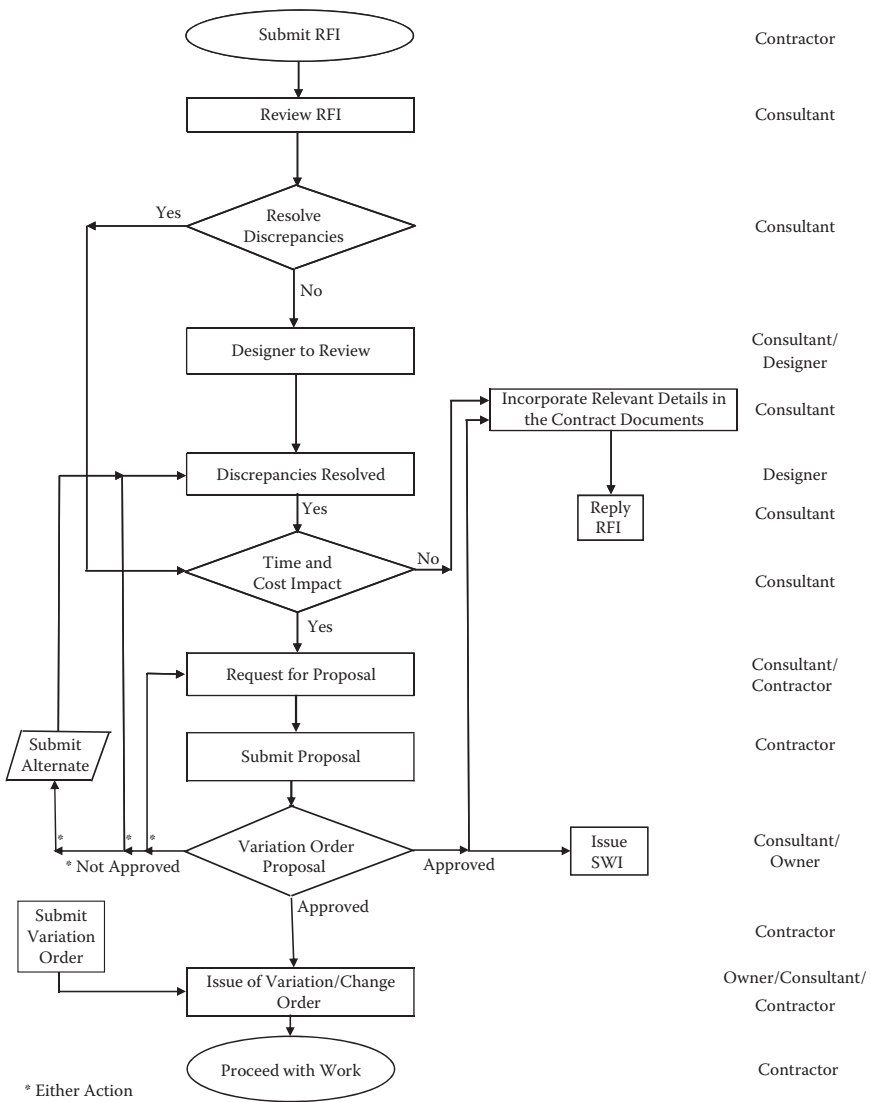

FIGURE 4.56
Flow diagram for processing RFI.

Project Name Consultant Name	
SITE WORK INSTRUCTION	
CONTRACT NO. : _____	NO. : _____
CONTRACTOR : _____	DATE : _____
<p style="text-align: center;"> SUBJECT: <u>SITE WORK INSTRUCTION (SWI)</u> </p> <h1 style="text-align: center; margin: 20px 0;">SAMPLE FORM</h1> <p style="text-align: center; margin: 20px 0;"> S.W.I. involves an anticipated change in the work. All S.W.I. must be authorized and signed by the Owner Representative OR Authorised Signatory. </p> <p style="text-align: center; margin: 20px 0;"> A S.W.I. is an instruction to the contractor to proceed prior to the issuing of a Variation Order (V.O.). Whenever time allows, a V.O. will be issued instead of S.W.I. . </p> <p style="display: flex; justify-content: space-between; margin-top: 20px;"> Owner Rep. Signature _____ Date _____ </p>	
THIS SITE WORKS INSTRUCTION (S.W.I.) IS A NOTICE TO PROCEED AND MAY INVOLVE CHANGE IN COST AND OR TIME. YOU ARE REQUIRED TO ADVISE THE ENGINEER WITHIN 14 DAYS OF ANY ADDITIONAL COST AND OR TIME REQUIRED TO COMPLY WITH THIS INSTRUCTION.	
RECEIVED FOR CONTRACTOR: _____ DATE: _____	
DISTRIBUTION: Owner <input type="checkbox"/> Engineer <input type="checkbox"/> R.E. <input type="checkbox"/>	

FIGURE 4.57
 Site work instruction.

Project Name	
Consultant Name	
REQUEST FOR VARIATION	
CONTRACT NO. _____	NO. : _____
CONTRACTOR: _____	DATE : _____
SAMPLE FORM	
TO : _____	
PROPOSED VARIATION:	
<input type="checkbox"/> PRODUCT	<input type="checkbox"/> METHOD OF FABRICATION
<input type="checkbox"/> METHOD OF INSTALLATION	
SPECIFIED PRODUCT _____	
PROPOSED PRODUCT _____	
SPEC. SECTION # _____	PAGE # _____
DRG REF _____	DRG # _____
SPECIFIED MANUFACTURER _____	ARTICLE # _____
PROPOSED MANUFACTURER _____	REV# _____
BRIEF PRODUCT DESCRIPTION _____	
REASON FOR PROPOSED VARIATION	
<input type="checkbox"/> CHANGE IN DESIGN	<input type="checkbox"/> REQUIRED BY AUTHORITIES
<input type="checkbox"/> SITE CONDITIONS	<input type="checkbox"/> SWI
COST AND TIME EFFECT	
COST	NO <input type="checkbox"/> YES <input type="checkbox"/>
TIME	NO <input type="checkbox"/> YES <input type="checkbox"/>
	AMOUNT -----(ADDITION)
	DAYS -----
ATTACHMENTS:	
1 Schedule of additions/ommissions	
2 Bill Summary	
3 Rate Analysis	
4 Measurements	
<small>Technical and cost comparison sheets must be attached with this request, other wise it will not be reviewed. Contractor shall fill and submit two forms to the OWNER. Front sheet only shall be returned to Contractor with OWNER action.</small>	
WE (THE MAIN CONTRACTOR) CERTIFIES AND UNDERTAKES THAT:	
CONTRACTOR'S REP _____	DATE/TIME _____
RECEIVED BY A/E _____	DATE/TIME _____
REVIEW AND ACTION BY OWNER	
<input type="checkbox"/> Approved	<input type="checkbox"/> Not Approved
<input type="checkbox"/> Approved as Noted	<input type="checkbox"/> Incomplete Data Resubmit
COMMENTS _____	
APPROVED SUBJECT TO COMPLIANCE WITH CONTRACT DOCUMENTS	
Authorised Signature _____	DATE/TIME: _____
<small>THE APPROVAL OF ANY VARIATION REQUEST SHALL BE SOLELY AT THE DIRECTION OF THE OWNER AND SUCH APPROVAL SHALL IN NO WAY RELIEVE THE CONTRACTOR OF ANY OF HIS LIABILITIES AND OBLIGATIONS UNDER THE CONTRACT.</small>	
RECEIVED BY CONTRACTOR: _____	DATE/TIME: _____
cc: OWNER <input type="checkbox"/>	EMPLOYER <input type="checkbox"/>
R.E. <input type="checkbox"/>	<input type="checkbox"/>

FIGURE 4.58 Request for variation order.

Project Name	
Consultant Name	
REQUEST FOR MODIFICATION	
(AT NO EXTRA COST & OR TIME TO THE EMPLOYER)	
CONTRACTOR : _____	DATE : _____
CONTRACT NO : _____	NO : _____
TO : Owner Name	CC: A/E <input type="checkbox"/>
PROPOSED MODIFICATION TO: <input type="checkbox"/> DESIGN DRAWING <input type="checkbox"/> METHOD OF FABRICATION <input type="checkbox"/> METHOD OF INSTALLATION DESIGN DRAWING NO _____ SECTION # _____ CONTRACTOR'S PROPOSED DRAWING NO. _____ REASON FOR MODIFICATION _____	
COST AND TIME SAVINGS <i>At no extra cost and or time to the Employer</i> COST NO <input type="checkbox"/> YES <input type="checkbox"/> AMOUNT (DEDUCTION) _____ TIME NO <input type="checkbox"/> YES <input type="checkbox"/> DAYS	
ATTACHMENTS: Supplier confirmation letter	
SAMPLE FORM	
CONTRACTOR'S REP _____	DATE/TIME _____
RECEIVED BY A/E _____	DATE/TIME _____
REVIEW AND ACTION BY OWNER <input type="checkbox"/> Approved <input type="checkbox"/> Not Approved <input type="checkbox"/> Approved as Noted <input type="checkbox"/> Incomplete Data Resubmit COMMENTS Authorised Signatories _____ DATE/TIME: _____	
RECEIVED BY CONTRACTOR: _____	DATE/TIME: _____
cc: Owner <input type="checkbox"/>	Engineer <input type="checkbox"/>
	R.E. <input type="checkbox"/>

FIGURE 4.59
Request for modification.

Project Name Consultant Name	
VARIATION ORDER PROPOSAL (VOP)	
CONTRACT NO: _____	VOP No. _____
CONTRACTOR: _____	Date: _____
<p>The "Employer" decision is requested for approval / rejection of this Variation Order Proposal as described below. Should the VOP be approved by the "Employer" an order to proceed shall be issued to the Contractor for his further action.</p>	
INITIATED / PROPOSED BY:	
<input type="checkbox"/> ENGINEER <input type="checkbox"/> ENGINEER'S REP. <input type="checkbox"/> CONTRACTOR <input type="checkbox"/> OTHERS	
REASONS:	
<input type="checkbox"/> CHANGE IN DESIGN <input type="checkbox"/> SWI _____ <input type="checkbox"/> REQUIRED BY AUTHORITIES <input type="checkbox"/> REQUIRED BY SITE CONDITIONS	
BRIEF DESCRIPTION & LOCATION:	
SAMPLE FORM	
BASIS OF V.O.EVALUATION:	
PRORATA BOQ PRICES:	<input type="checkbox"/>
PROPOSAL from CONTRACTOR:	<input type="checkbox"/>
APPROXIMATE COST IMPACT _____	APPROXIMATE % _____
APPROXIMATE TIME IMPACT _____	ANY DELAY _____
RELATED REFERENCES:	
ENGINEER'S RECOMMENDATION:	
RESIDENT ENGINEER'S SIGNATURE _____	DATE: _____
Distribution: <input type="checkbox"/> Employer <input type="checkbox"/> Engineer <input type="checkbox"/> Resident Engineer <input type="checkbox"/>	

FIGURE 4.60
Variation order (proposal).

Figure 4.61A shows the variation order form issued to formalize the change order, and Figure 4.61B shows the attachment to the change order.

4.5.6 Quality Control

The construction project quality control process is the part of the contract documents that provides details about specific quality practices, resources, and activities relevant to the project. The purpose of quality control during construction is to ensure that the work is accomplished in accordance with the requirements specified in the contract. Inspection of construction works is carried out throughout the construction period either by the construction supervision team (consultant) or the appointed inspector agency. Quality is an important aspect of a construction project. The quality of a construction project must meet the requirements specified in the contract documents. Normally, the contractor provides onsite inspection and testing facilities at the construction site. On the construction site, inspection and testing are carried out in three stages during the construction period to ensure quality compliance:

1. During the construction process. This is carried out with the checklist request submitted by the contractor for testing ongoing work before proceeding to the next step.
2. Receipt of subcontractor or purchased material or services. The contractor submits a material inspection request to the consultant upon receipt of material.
3. Before final delivery or commissioning and handover.

Quality management in construction is a management function. In general, quality assurance and control programs are used to monitor design and construction conformance to established requirements as determined by the contract specifications. Instituting quality management programs reduces costs while producing the specified facility.

Regarding the importance of quality in construction, Chung (1999) states that:

In the construction industry, which is project-oriented, a contractor may be working at any one time for a number of clients on a variety of projects. Each project has its own characteristics and requirements. The contractor's quality system must be capable of being tailored to meet the specific needs of the project. The mechanism for doing so is the project quality plan, simply called the quality plan. Preparation of a quality plan ensures that specific requirements of the project are considered and planned for. It also demonstrates to the client how the requirements will be met. (p. 42)

Figure 4.62 shows quality assurance and quality control typical responsibilities.

Project Name Consultant Name	
VARIATION ORDER (VO)	
CONTRACT NO. : _____	V.O. NO.: _____
CONTRACTOR : _____	DATE : _____
In accordance with clause ---- of Document ---- Conditions of Contract, you hereby ordered to undertake work and/or amend the Contract as detailed below:	
DESCRIPTION OF WORK	
SAMPLE FORM	
According to Clause -----, Extension of Time for Completion and Valuation of V.O. are as follows:	
Original Contract Price: _____	Contract Completion Date: _____
Previous Vos: _____	Previous Extension(s): _____
Value This VO: _____	Extension This VO: _____
Revised Contract Price: _____	Revised Completion Date: _____
We the undersigned Contractor hereby agree to carry out the works as ordered by this Variation Order and accept in full and final settlement of all related consequential costs and time	
_____ Recommended by Resident Engineer	_____ Agreed by Contractor
_____ Recommended by Engineer	_____ Agreed by Employer

Distribution Employer
 Engineer
 Resident Engineer
 Contractor

FIGURE 4.61A
 Variation order.

Project Name Consultant Name

ATTACHMENT TO VARIATION ORDER

CONTRACTOR: _____ CONTRACT No.: _____

V. O. No. _____	Date: _____
1. Site Works instructions incorporated into this Variation Order:	
2. Previous correspondence references (attached):	
SAMPLE FORM	
3. Revised Drawings and Specifications (attached):	
4. Schedule of Omissions/Additions:	
5. Rate Analysis for New Items:	

FIGURE 4.61B
Attachment to variation order.

Responsibility ⇓	Owner	Design Professional	Constructor	Design Builder
Set overall approach to attitude and quality	●	⊙	⊙	⊙
Develop and implement design phase QA/QC program	⊙	●	⊙	●
Conduct design audits or review		●	⊙	●
Incorporate QA/QC measures in construction contract bid documents	⊙	●	⊙	●
Evaluate construction bids	●	⊙	○	⊙
Develop and implement construction phase QA/QC program	⊙	⊙	●	●*
Set measurable goals or standards for construction quality	⊙	⊙	●*	●
Provide documentation of progress toward construction QA/QC goals	○	⊙	●	●
Communicate regularly with team members regarding quality concerns	●	●	●	●

* May engage qualified consultant or other design staff not assigned to project for design reviews or audits.

● = Primary Responsibility ⊙ = Assist or Advise ○ = Review

FIGURE 4.62 QA/QC typical responsibilities. (From American Society of Civil Engineers, *Quality in the Constructed Project*, 2000. Reprinted with permission of ASCE.)

Construction project documents usually specify in detail the materials and workmanship required and also specify the type of inspection and tests to be performed to prove compliance. The contractor submits a quality control plan to achieve the required quality standards and objectives of the project.

With the commencement of the project, the activities related to mobilization such as setting up of site offices, stores, etc., starts, followed by excavation and installation of dewatering and shoring systems.

Quality in construction is achieved through proper control at every stage of execution and installation of works. The contractor should have complete knowledge of the project he or she has been contracted to construct. Safe and reliable construction should be the objective of all the participants of the project. The contractor has to submit shop drawings, materials, products, equipment, and systems to the owner/consultant for their review and approval before they can be installed on the project. The procedure and requirements for submitting shop drawings, materials, and samples are specified in detail under the "Submittal" section of the contract specifications.

4.5.6.1 Shop Drawings Approval

The contract drawings and specifications prepared by the design professionals are indicative and are generally meant for determining the tender pricing and for planning the construction project. In many cases, they are not sufficient for installation or execution of works at various stages. More details are required during the construction phase to ensure the specified quality. These details are provided by the contractor on the shop drawings. Shop drawings are used by the contractor as reference documents to execute/install the works. A detailed shop drawing helps the contractor achieve zero defects in installation at the first stage, thus avoiding any rejection/rework. Based on the contract drawings, the contractor prepares shop drawings and submits them to the consultant for approval. All the work is executed per the approved shop drawings. The contractor's shop drawings are prepared taking into consideration the following, at a minimum, to meet the design intent.

4.5.6.1.1 Architectural Works

The architectural works shop drawings mainly cover masonry, doors and windows, cladding, partitioning, reflected ceiling, stone flooring, toilet details, stairs details, and roofing. The elements of these shop drawings for these sections are as follows:

- A. Masonry: The shop drawings for masonry works shall include at a minimum
 - Area layout
 - Guidelines

- Height of masonry
 - Type and thickness of blocks used for masonry
 - Reinforcement details
 - Fixation details
 - Openings in the block works for other services
 - Sills
 - Lintels
 - Plastering details, if applicable
- B. Doors and windows: The shop drawings for doors and windows shall include
- Size of doors and windows
 - Type of material
 - Thickness of frames
 - Details of door leaves
 - Details of glazing
 - Fixing details
 - Schedule of doors and windows
- C. Cladding: The shop drawings for cladding shall include
- Type of cladding material
 - Size of panels/tiles and thickness
 - Elevations
 - Fixation method, anchorage and supports
 - Openings for other services
- D. Partitioning: The shop drawings for partitions shall include
- Type of partitioning material
 - Size of panels
 - Frame size and its installation details
 - Partition support system
 - Fixation details of panels
- E. Reflected ceiling: The shop drawings for reflected ceiling shall include
- Type of ceiling material
 - Size of ceiling panels, thickness of material
 - Ceiling level

- Suspension system and framing
- Layout showing jointing layout, faceting and boundaries between materials
- Location of light fittings, detectors, sprinklers, grills, etc.
- Location of access panel

F. Stone flooring: The shop drawings for flooring shall include

- Type of flooring material
- Size of flooring tiles
- Layout
- Screeding details
- Jointing details
- Flooring pattern
- Cut out for other services
- Control joints and jointing method
- Antislip inserts
- Separators
- Thresholds

G. Toilet details: The shop drawings for toilet details shall include

- Layout
- Plan
- Sections
- Installation details of sanitary ware and fixtures
- Installation details of toilet accessories
- Jointing method
- Material finishes and surface textures
- Installation details of toilet mirror

H. Stairs details: The shop drawings for stairs details shall include

- Steps details, riser, treads, width, height
- Finishing details
- Handrail details
- Sections
- Plan

I. Roofing waterproofing: The shop drawings for roofing details shall include

- Insulation details
- Installation details of insulation
- Installation of waterproofing material
- Control joints/expansion joints details
- Tiling details
- Flashings

4.5.6.1.2 Structural Works

The structural works shop drawings to be prepared according to ACI 315 will mainly cover reinforced concrete, formwork, precast concrete, and structural steel fabrication. The elements in these shop drawings are as follows:

A. Reinforced concrete: The reinforced concrete works shop drawings to be prepared according to ACI 315 should have the following details:

- The size of reinforcement material
- Bar schedule
- Stirrup spacing
- Bar bent diagram
- Arrangement and support of concrete reinforcement
- Dimensional details
- Special reinforcement required for openings through concrete structure
- Type of cement and its strength

B. Formwork: Formwork has great importance from the safety point of view. The shop drawing of formwork shall include

- Details of individual panels
- Position, size, and spacing of adjustable props
- Position, size, and spacing of joints, solders, ties, and the like
- Details of formwork for columns, beams, parapet, slabs, and kickers
- Details of construction joints and expansion joints
- Details of retaining walls, core walls, and deep beams showing the position and size of ties, joints, solders, and sheeting, together with detailed information on erection and casting sequences and construction joints

- General assembly details, including propping, prop bearings, and through propping
 - All penetrations through concrete
 - Full design calculations
- C. Precast concrete: The shop drawings for precast concrete works have great importance as the casting is carried out at a precast concrete factory. All the required details need to be shown on these drawings to ensure that precast elements are produced without any defects. The shop drawing should provide details of fabrication and installation of precast structural concrete units. It should indicate member location, plans, elevations, dimensions, shapes, cross sections, openings, and type of reinforcement, including special reinforcement, if any. The following information also has to be indicated in the shop drawings:
- Welded connections by American Welding Society's standards symbol
 - Details of loose and cast-in hardware, insets, connections, joints, and all types of accessories
 - Location and details of anchorage device to be embedded in other construction
 - Comprehensive engineering analysis including fire-resistance analysis
- D. Structural steel fabrication: The shop drawings for fabrication of structural steel shall include
- Details of cuts, connections, splices, camber, holes, and other pertinent data
 - Welding standards symbols
 - Size and length of bolts, indicating details of material and strength of bolts
 - Details of steel bars, plates, angles, beams, channels
 - Method of erection
 - Details of anchorage details, templates, and installation details of bolts

4.5.6.1.3 Elevator Works

- Overall elevation (vertical) for elevator area
- Floor levels
- Hoist way plan, sections, and anchoring details for installation of rails

- Machine room plan and installation details for drive and controller
- Equipment layout in machine room/hoist way
- Cuttings/openings, sleeves required in the concrete slab/walls
- Details and level of cab overhead
- Details and levels about the pit
- Location and level of hall button and hall position indicator
- Openings for landing door, entrance view, and finishes level
- Finishes of cab, door, indicators
- Power supply devices and equipment earthing
- Interface with elevator management system, if any

4.5.6.1.4 HVAC Works

The shop drawing for HVAC works should include, but not be limited to, the following:

- Location of equipment and their configuration
- Piping size
- Piping route and levels
- Ducting size
- Ducting route and levels
- Insulation details
- Suspension/hanger details
- Equipment layout and plan
- Riser diagram for chilled water system
- Installation details of equipment
- Size of diffusers and grills
- Installation details of grills
- Exhaust and ventilation fans layout and details
- Riser diagram for exhaust air system
- Return air opening details
- Equipment schedule
- Electrical connection and power supply details
- Control details
- Sequence of operation
- Schematic diagram for HVAC system
- Schematic diagram for building management system by configuring all the equipment and components

4.5.6.1.5 Mechanical Works (Plumbing and Firefighting)

The shop drawings for mechanical works should include, but not be limited to, the following:

- Riser diagram for water supply system
- Size of piping
- Piping route and levels
- Size of isolating valves and their location
- Equipment plan layout
- Storage tank details
- Electrical power connection details
- Details of toilet accessories and connection details
- Riser diagram for rain water system
- Drainage system piping
- Riser diagram for storm water system
- Storm water system
- Sprinkler layout
- Hose reel details
- Hose reel cabinet size, location, and installation details
- Fire pump location and installation details
- Location of flow switches
- Interface with fire alarm and BMS

4.5.6.1.6 Electrical Works

The shop drawings for electrical works should indicate, but not be limited to, the following:

- The shop drawings for electrical works should indicate but are not limited to
- Size and type of conduits, raceways, and exact routing of the same
- Size of cable trays, cable trunking, installation methods and exact route indicating the level
- Size of wires and cables
- Wiring accessories with circuit references
- Lighting layout with circuit references
- Installation details of light fixtures
- Small power layout
- Large power layout

- Installation details of distribution boards, switch boards, and panels
- Field installation wiring details for light, power, controls, and signals
- Panels, switch board layout in L.T. room
- Diesel generator installation details
- Schematic diagram showing the configuration of all the equipment
- Load schedules per actual connected loads
- Voltage drop calculations
- Earthing system
- Lightning protection system

4.5.6.1.7 HVAC Electrical Works

The shop drawings for HVAC electrical works should include

- Wiring diagram of individual components and accessories
- MCC panels, starter panels and their installation details
- Schematic diagram including power and control wiring
- Type and size of conduit, and number and size of wires in the conduit
- Type and size of cable
- Details of protection and interlocks
- Details of instrumentation
- Description of sequence of operation of equipment

4.5.6.1.8 Low-Voltage Systems

The shop drawings for low-voltage systems such as BMS, Fire Alarm System, Communication System, Public Address System, Audio Visual System, CCTV/Security System, and Access Control System should include

- Size of conduits and raceways, their routing and levels
- Location of components, wiring accessories
- Installation details of components, wiring accessories
- Wiring and cabling details
- Installation details of racks
- Installation details of equipment
- Schematic/riser diagram configuring all the components and equipment used in the system
- Interface with other systems

4.5.6.1.9 Landscape Works

The shop drawings for landscape works should include

- Boundary limit
- Excavation area
- Excavation level
- Type of soil in different areas
- Location of plants, trees, shrubs, etc.
- Foundation details for plants, trees, shrubs, etc.
- Location of sidewalk
- Location of driveways
- Foundation for paving
- Grass areas
- Location of services, ducts for utilities
- Location of light poles/bollards
- Foundation for light poles/bollards
- Details of special features
- Details of irrigation system

4.5.6.1.10 External Works (Infrastructure)

The shop drawing for external works (infrastructure) should include

- Width of the road
- Grading details
- Thicknesses of asphalt layers
- Pavement details
- Location of manholes and levels
- Services/utilities pipe routes
- Location of light poles
- Cable routes
- Trench details
- Road marking
- Traffic sign and signals

Figure 4.63 illustrates a site transmittal for shop drawings approval.

Project Name
Consultant Name
SITE TRANSMITTAL
Request for Shop Drawings Approval

CONTRACT No.: _____ TRANSMITTAL NO. _____ REV. _____

CONTRACTOR :

TO :

WE REQUEST APPROVAL OF THE FOLLOWING ENCLOSED DRAWINGS

ITEM NO.	DWG., SPEC. OR BOQ. REF.	DRAWING TITLE	DWG. NOS.	Rev.	SUBMITTAL CODE *	ACTION CODE **
SAMPLE FORM						

N.B: We certify that above items have been reviewed in detail & are correct & in strict performance with the Contract Drawings & Specification except as otherwise stated.

CONTRACTOR'S REP. : _____ DATE : _____

RECEIVED BY CONSULTANT : _____ DATE : _____

cc: Owner Rep.

Resident Engineer to enter ACTION CODE and REMARKS

R.E.'s REMARKS :

Initials _____ Date _____

Corrections or comments made relative to submittals during this review do not relieve Contractor from compliance with the requirements of the Drawings and Specifications. This check is only for review of general conformance with the design concept of the project and general compliance with the information given in the Contract Documents. Contractor is responsible for confirming and correlating all quantities and dimension selecting fabrication process and techniques of construction, coordinating his work with that of other trades, and performing his work in a safe and satisfactory manner.

Resident Engineer : _____ DATE : _____

Received by Contractor : _____ DATE : _____

cc: Owner Rep.

cc: Project Manager 1: Submitted for Approval 2: Submitted for your Information 3:	** ACTION CODE: A: Approved C: Not Approved B: Approved as Noted D: For Information
--	--

FIGURE 4.63
 Site transmittal for workshop drawings.

4.5.6.1.11 Builder's Workshop Drawings

The contractor submits builder's workshop drawings, which are prepared to show all the openings required in the civil or architectural work for services and other trades. These drawings are based on the approved shop drawings of all related trades. These drawings indicate the size of openings, sleeves, and level references with the help of detailed elevations and plans of the building, fully coordinating the requirements of all the trades. Detailed sections are also shown for complicated areas.

4.5.6.1.12 Composite/Coordination Shop Drawings

The contractor's composite drawings are prepared taking into consideration approved shop drawings, builders workshop drawings, and material approval to show the relationship of components shown on the related shop drawings and to indicate required installation sequence and exact location. Composite drawings show the interrelationship of all services with each other and with the surrounding civil and architectural work. Composite drawings show detailed coordinated cross sections, elevations, reflected plans, etc., resolving all conflicts in levels, alignment, access, space, etc., and the actual physical dimensions required for installation of panels, equipment, plant, etc., within the available space.

Figure 4.64 illustrates a logic flow diagram for preparation of shop drawings/composite drawings.

4.5.6.2 Materials Approval

All the materials, equipment, and systems specified in the contract documents need prior approval from the owner/consultant. Figure 4.65 shows a site transmittal form for material approval.

Figure 4.66 shows specification comparison statement to be submitted along with the material transmittal.

If the contractor is unable to obtain the specified product or is unable to find an approved equivalent product, then he or she may propose a substitute product for the approval of the consultant/owner for their review and approval. Figure 4.67A,B shows a request for substitution of material.

Upon receipt of material at site, the contractor submits the material inspection report.

Figure 4.68 shows a material inspection report.

The work at site is executed per approved shop drawings with approved materials only.

Quality of construction has mainly three elements:

- a. Defined scope
- b. Budget
- c. Schedule

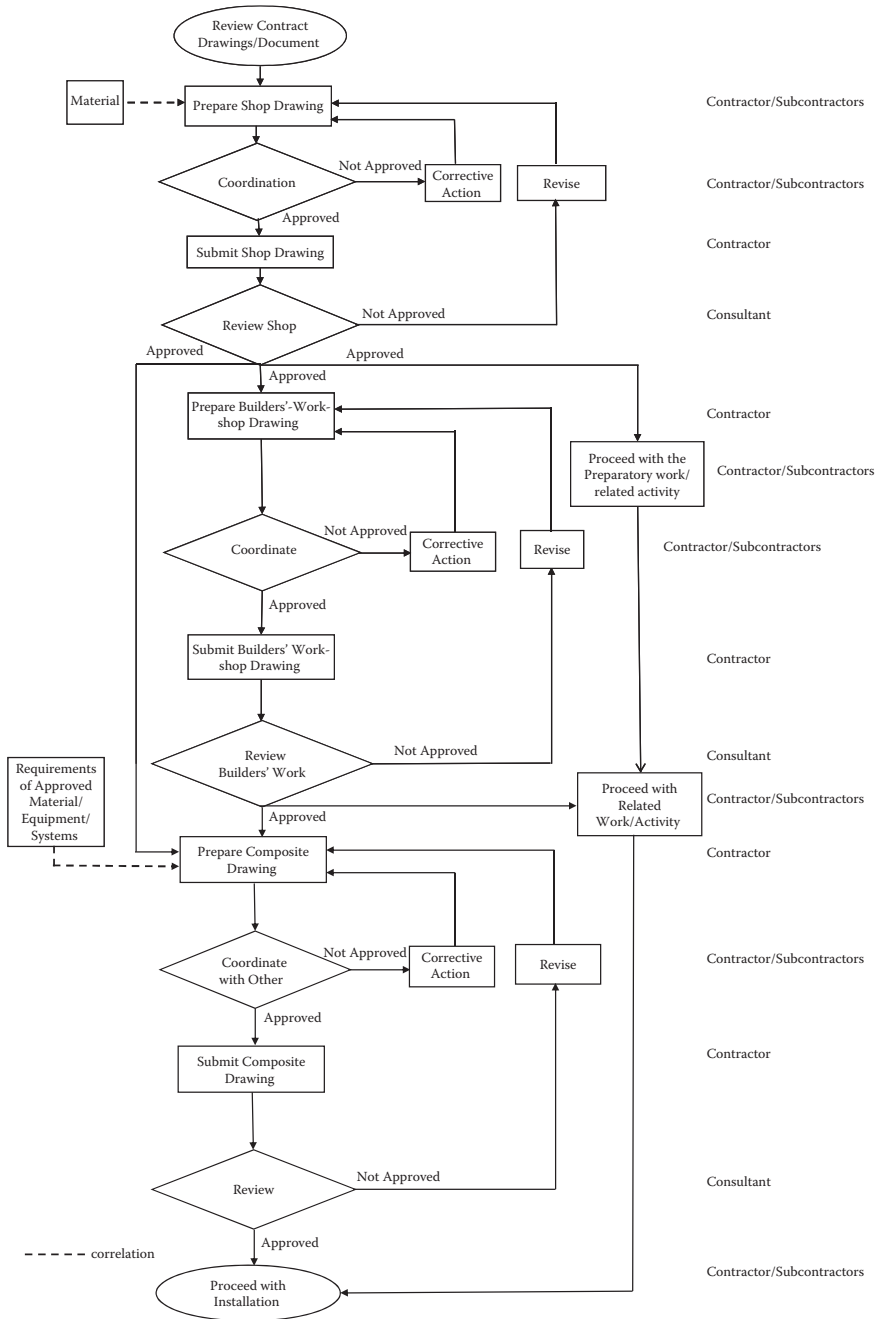

FIGURE 4.64 Logic flow diagram for shop drawings/composite drawings.

Project Name
Consultant Name
SITE TRANSMITTAL
Request for Material Approval

CONTRACT No. : _____ TRANSMITTAL NO. _____ REV. _____
 CONTRACTOR : _____
 TO : _____

WE REQUEST APPROVAL OF THE FOLLOWING MATERIALS/GOODS/PRODUCTS/EQUIPMENT

ITEM NO.	DWG., SPEC. OR BOQ. REF.	DESCRIPTION	SUBMITTAL CODE *	ACTION CODE **
SAMPLE FORM				

DETAILS OF INFORMATION, LITERATURE, CATALOG CUTS, AND THE LIKE ATTACHED ARE:

SAMPLES:
 Enclosed Submitted under separate cover Not applicable

NB: We certify that above items have been reviewed in detail & are correct & in strict performance with the Contract Drawings & Specification except as otherwise stated.

CONTRACTOR'S REP. : _____ DATE : _____
 RECEIVED BY CONSULTANT : _____ DATE : _____

cc: Owner Rep. _____
Resident Engineer to enter ACTION CODE and REMARKS

R.E.'s REMARKS :

Initials _____ Date _____

Corrections or comments made relative to submittals during this review do not relieve Contractor from compliance with the requirements of the Drawings and Specifications. This check is only for review of general conformance with the design concept of the project and general compliance with the information given in the Contract Documents. Contractor is responsible for confirming and correlating all quantities and dimensions, selecting fabrication process and techniques of construction, coordinating his work with that of other trades and performing his work in a safe and satisfactory manner.

Resident Engineer : _____ DATE : _____
 Received by Contractor : _____ DATE : _____

cc: Owner Rep. _____

* SUBMITTAL CODE: I: Submitted for Approval	** ACTION CODE: A: Approved C: Not Approved
---	--

FIGURE 4.65
 Site transmittal for material approval.

Project Name Consultant Name			
SPECIFICATION COMPARISON STATEMENT (SCS)			
Contractor: _____		Date: _____	
Contract No: _____		A/S No: _____	
Submittal No. : _____	Revision: _____	Transmittal Ref: _____	
Submittal Title: _____		Specification Ref: _____	
S No.	SPECIFICATION REQUIREMENTS	CONTRACTOR'S PROPOSAL	REMARKS

FIGURE 4.66
Specification comparison statement.

The contractor has to comply with all the requirements specified under contract documents. The contractor executes the work per the approved quality control plan (CQP). The contractor’s CQP is the contractor’s everyday tool to ensure quality.

During the construction process, the contractor has to submit the checklists to the consultant to inspect the work. Submission of checklists or requests for inspection is an ongoing activity during the construction process to ensure proper quality control of construction. Concrete work is one of the most important components of building construction. The concrete work has to be inspected and checked at all the stages to avoid rejection or rework. Necessary care has to be taken right from the control of the design mix of the concrete until the casting is complete and cured. The contractor has to submit checklists at different stages of concrete work and has to ensure that tests specified in the contract are performed during casting of concrete. The following are the checklists that contractor submits at different stages of the concreting process:

- Figure 4.69 shows the checklist for quality control of form work.
- Figure 4.70 shows the notice for daily concrete casting.
- Figure 4.71 shows the checklist for concrete casting.
- Figure 4.72 shows the checklist for quality control of concreting.
- Figure 4.73 shows the report on concrete casting.
- Figure 4.74 shows the notice for testing at the laboratory.
- Figure 4.75 shows the concrete quality control form.

Project Name Consultant Nme				
REQUEST FOR ALTERNATIVE OR SUBSTITUTION (A/S)				
Contractor: _____	A/S No. _____			
Contract No. _____				
SUBJECT: _____	DATE: _____			
"The Contractor shall comply with the requirements of Doc----- Section ----- prior to submission of this request".				
DESCRIPTION OF CONTRACTED ITEM FOR WHICH ALTERNATIVE OR SUBSTITUTION IS PROPOSED: SAMPLE FORM				
Section: _____	Page: _____	Specification Ref: _____		
REASON FOR PROPOSED ALTERNATIVE OR SUBSTITUTION: _____				
PROPOSED ALTERNATIVE OR SUBSTITUTION:				
<input type="checkbox"/> Product	<input type="checkbox"/> Method of Fabrication	<input type="checkbox"/> Method of Installation		
Manufacturer: _____	Address: _____	Phone #: _____		
Trade Name: _____	Model #: _____			
<input type="checkbox"/> History	<input type="checkbox"/> New Product	<input type="checkbox"/> 2-5 Years Old	<input type="checkbox"/> 5-10 Years Old	<input type="checkbox"/> More than 10 years old
Difference between proposed alternative OR substitution and specified: _____ _____				
<input type="checkbox"/> Point-by-point comparative data sheet is ATTACHED as per Ref: -----				
Proposed alternative or substitution affects other parts of Work:			<input type="checkbox"/> No	<input type="checkbox"/> Yes; explain
SIMILAR INSTALLATION OF PROPOSED ALTERNATIVE OR SUBSTITUTE:				
Project: _____	Engineer: _____			
Address: _____	Owner: _____			
	Date Installed: _____			

FIGURE 4.67A
Request for substitution.

<p>Project Name</p> <p>Consultant Name</p> <p>CONTRACT No.:</p> <p>CONTRACTOR :</p> <p style="text-align: center;">MATERIAL INSPECTION REPORT</p>			
<u>Description of material for inspection: -</u>		MIR No. :	<input style="width: 100%;" type="text"/>
		Date :	<input style="width: 100%;" type="text"/>
		Contract No. :	<input style="width: 100%;" type="text"/>
		Transmittal No. :	<input style="width: 100%;" type="text"/>
		Spec/Drg.ref. :	<input style="width: 100%;" type="text"/>
Qty. required	Qty. delivered	Total delivered	Attachments
SAMPLE FORM			
Inspection Location :		Date of Material Delivery :	
Contractor's Comments: -			
Contractor's Signature :		Date :	
Inspection Comments :			
Comply with Approved Transmittal: YES <input type="checkbox"/> NO <input type="checkbox"/>			
Signature of Inspection Engineer :		Date :	
Signature of R.E. :		Date :	

FIGURE 4.68
Material inspection report.

Project Name
Consultant Name

**QUALITY CONTROL OF FORMWORK / FALSEWORK /
DIMENSIONS / LEVELS**

CONTRACTOR: _____ DATE :

--	--	--

CONTRACT NO: _____

Site Engineer : _____
Inspected Element : _____
(N.B.: This form is to be prepared by the Site Engineer and submitted to the R.E.)

(A=Acceptable, N=Needs Adjustment, U=Unsatisfactory)

1) Form Dimensions & Levels :

		<table border="1" style="width: 100%;"><tr><th style="width: 33%;">A</th><th style="width: 33%;">N</th><th style="width: 33%;">U</th></tr><tr><td> </td><td> </td><td> </td></tr><tr><td> </td><td> </td><td> </td></tr><tr><td> </td><td> </td><td> </td></tr></table>	A	N	U									
A	N	U												
1.1	Setting Out													
1.2	Top of Concrete Level Ready for Casting													
1.3	Dimensions													
1.4	Heights & Levels													
1.5	Chamfers													

2) Falsework :

		<table border="1" style="width: 100%;"><tr><th style="width: 33%;">A</th><th style="width: 33%;">N</th><th style="width: 33%;">U</th></tr><tr><td> </td><td> </td><td> </td></tr><tr><td> </td><td> </td><td> </td></tr><tr><td> </td><td> </td><td> </td></tr><tr><td> </td><td> </td><td> </td></tr><tr><td> </td><td> </td><td> </td></tr></table>	A	N	U															
A	N	U																		
2.1	Supports																			
2.2	Rigidity																			
2.3	Bracing																			
2.4	Screw Jacks																			
2.5	Timber Straightness																			
2.6	Splices of Vertical Members																			

3) Formwork :

		<table border="1" style="width: 100%;"><tr><th style="width: 33%;">A</th><th style="width: 33%;">N</th><th style="width: 33%;">U</th></tr><tr><td> </td><td> </td><td> </td></tr><tr><td> </td><td> </td><td> </td></tr><tr><td> </td><td> </td><td> </td></tr><tr><td> </td><td> </td><td> </td></tr><tr><td> </td><td> </td><td> </td></tr><tr><td> </td><td> </td><td> </td></tr></table>	A	N	U																		
A	N	U																					
3.1	Rigidity																						
3.2	Water Tightness																						
3.3	Steel Bolts / Rods / Ties																						
3.4	Openings & Inserts																						
3.5	Cleanliness																						
3.6	Oiling																						
3.7	Working Platforms and Walkways																						

R.E's Comments :

Signature of Resident Engineer _____ Date : _____

FIGURE 4.69
Checklist for form work.

Project Name
Consultant Name

NOTICE OF DAILY CONCRETE CASTING

CONTRACTOR:
CONTRACT NO:

DATE :

The following is the tentative schedule of our concrete casting for elements already inspected and accepted for casting this day :

NO.	LOCATION	ELEMENT	GRADE Mpa	QTY m ³	TENTATIVE CASTING TIME	
					START	FINISH
SAMPLE FORM						
TOTAL						

Your action for supervision of the above would be very much appreciated.

SITE ENGINEER _____	CONTRACTOR MANAGER _____
----------------------------	---------------------------------

CONSULTANT RECEIVED: _____ Date: TIME: _____

R. E's COMMENTS:-	
Resident Engineer	Date

FIGURE 4.70
Notice for daily concrete casting.

In certain projects, the owner asks the contractor to involve an independent testing agency for quality control of the concrete. The agency is responsible for quality control of materials, performing tests, and submitting test reports to the owner.

The contractor has to submit checklists for all the installations and work executed per the contract documents and per the approved shop drawings and materials. Figure 4.76 shows the checklist for general works to be inspected by the consultant.

Project Name
Consultant Name

CHECKLIST FOR CONCRETE CASTING

CONTRACTOR: _____

CONTRACT NO: _____

Date : / /

Building / Structure : _____
Element : _____

No.	Description	Status	
		Availability	Detail
PLANT & TOOLS			
1	Concrete Pumps		
2	Standby Concrete Pumps		
3	Cranes		
4	Truck Mixers		
5	Vibrators		
6	Trowlers		
7	Lighting		
8	Access Means		
9	Communications		
QUALITY CONTROL			
1	Cubes		
2	Slump Apparatus		
3	Thermometer		
STAFF & LABOUR			
1	Engineer		
2	Foreman		
3	Carpenter		
4	Steel Fixer		
5	Electrician		
6	Mechanic		
7	Vibrating Labour		
8	Trowing Labour		
9	Ordinary Labour		

SAMPLE FORM

SITE ENGINEER

CONTRACTOR MANAGER

CONSULTANT RECEIVED: _____

DATE: / /

TIME: _____

COMMENTS: _____

Signature of Resident Engineer: _____

Date: _____

FIGURE 4.71
Checklist for concrete casting.

Project Name

Consultant Name

QUALITY CONTROL OF CONCRETING

CONTRACTOR: _____ DATE:

--	--	--

CONTRACT NO: _____

Site Engineer	: _____						
Inspected Element	: _____						
(N.B.: This form is to be prepared by the Site Engineer and submitted to the Consultant)							
Starting Time Maximum Recorded Temperature	<table border="1" style="width: 100%; height: 30px;"> <tr><td style="width: 20px;"></td><td style="width: 20px;"></td><td style="width: 20px;"></td></tr> </table>						
Finishing Time Total Concrete Quantity Average Slump Cubes ID's	<table border="1" style="width: 100%; height: 30px;"> <tr><td style="width: 20px;"></td><td style="width: 20px;"></td><td style="width: 20px;"></td></tr> </table>						
Number of Vibrators Available through Process Compaction (S=Satisfactory, U=Unsatisfactory)	<table border="1" style="width: 100%; text-align: center;"> <tr><td style="width: 20px;">S</td><td style="width: 20px;">U</td></tr> </table>	S	U				
S	U						
Preparation of Previous Construction Joints Stopped at Preplanned Locations Preparation of New Construction Joints	<table border="1" style="width: 100%; text-align: center;"> <tr><td style="width: 20px;">Yes</td><td style="width: 20px;">No</td></tr> <tr><td style="width: 20px;">Yes</td><td style="width: 20px;">No</td></tr> <tr><td style="width: 20px;">Yes</td><td style="width: 20px;">No</td></tr> </table>	Yes	No	Yes	No	Yes	No
Yes	No						
Yes	No						
Yes	No						
Curing Starting Time	<table border="1" style="width: 100%; height: 20px;"> <tr><td style="width: 100%;"></td></tr> </table>						
Measurements of Falsework / Formwork Deformation after casting (S=Satisfactory, U=Unsatisfactory).	<table border="1" style="width: 100%; text-align: center;"> <tr><td style="width: 20px;">S</td><td style="width: 20px;">U</td></tr> </table>	S	U				
S	U						
<u>R.E's Comments :</u> _____ _____ _____							
Resident Engineer : _____	Date : _____						

FIGURE 4.72
Quality control of concreting.

If the consultant finds that an item has been executed at site that is not in accordance with contract documents, specifications, or general code of practice, then a remedial note is issued by the consultant. Figure 4.77 shows a remedial note.

The contractor is required to reply on the same form after taking necessary action. Upon finalization of the issue, the withdrawal notice is issued by the consultant/supervision staff.

Project Name
Consultant Name

NOTICE FOR TESTING AT SITE LAB.

CONTRACTOR:
CONTRACT NO:

Date : / /

The following is the tentative schedule for testing activities in the Site Laboratory.

I. SOIL TESTING

NO.	LOCATION	SAMPLE	TYPE OF TESTING

II. CONCRETE CUBES TESTING

NO.	LOCATION	AGE OF CONCRETE	NO. OF CUBES

SAMPLE FORM

We request your to witness the testing at.....A.M./P.M.

SITE ENGINEER _____	CONTRACTOR MANAGER _____
-----------------------------------	--

CONSULTANT RECEIVED: _____ **Date:** / / **Time:** _____

R.E's Comments :	_____
Signature of Resident Engineer:	Date:

FIGURE 4.74
Notice for testing at laboratory.

Project Name											
Consultant Name											
CONCRETE QUALITY CONTROL FORM											
CONTRACTOR: _____						Serial No.: _____					
CONTRACT NO: _____											
Building _____				Drawing Refer. _____				Concrete Temp. _____			
Particular Area _____				Type of Concrete _____				Slump (mm) _____			
Date of Cube _____				Special Material _____				Drawing Refer. _____			
Conc. Supplier _____				Truck # _____							
➡ Date of Test ____ / ____ / ____						Age of Cubes ____ Days					
Cube No.	Width cm	Length cm	Height cm	Area cm ²	Weight gram	Volume cm ³	Density g/cm ³	Failing Load kN	Compressive N/mm ² Strength	Type of Failure	
1											
2											
3											
Required 7 Day Strength _____						Average Comp. Strength _____					
_____ Laboratory Technician				_____ Consultant				_____ Contractor			
➡ Date of Test _____						Age of Cubes ____ Days					
Cube No.	Width cm	Length cm	Height cm	Area cm ²	Weight gram	Volume cm ³	Density g/cm ³	Failing Load kN	Compressive N/mm ² Strength	Type of Failure	
1											
2											
Required 14 Day Strength _____						Average Comp. Strength _____					
_____ Laboratory Technician				_____ Consultant				_____ Contractor			
➡ Date of Test _____						Age of Cubes ____ Days					
Cube No.	Width cm	Length cm	Height cm	Area cm ²	Weight gram	Volume cm ³	Density g/cm ³	Failing Load kN	Compressive N/mm ² Strength	Type of Failure	
1											
2											
Required 28 Day Strength _____						Average Comp. Strength _____					
_____ Laboratory Technician				_____ Consultant				_____ Contractor			
Distribution: <input type="checkbox"/> Owner				<input type="checkbox"/> A/E				<input type="checkbox"/> Contractor			

FIGURE 4.75 Concrete quality control form.

Project Name Project Name CHECK LIST	
CONTRACTOR : _____ CONTRACT No. : _____ TO : Resident Engineer	CHECK LIST No. : <input style="width: 50px;" type="text"/> PREVIOUS C.L. No. : <input style="width: 50px;" type="text"/>
CCS ACTIVITY NO : _____ SPECIFICATION DIVISION : _____ SECTION : _____ AREA : <input type="checkbox"/> Building Works <input type="checkbox"/> Electrical Works <input type="checkbox"/> Mechanical Works <input type="checkbox"/> HVAC Works <input type="checkbox"/> Finishes Works <input type="checkbox"/>	
Please inspect the following :- <hr/> Location : _____ Work : _____ <div style="text-align: center; font-size: 2em; font-weight: bold; opacity: 0.5; margin: 10px 0;">SAMPLE FORM</div> <hr/> Sketch(es) attached () No. _____ <hr/>	
<p>The work to be inspected has been coordinated with all related subcontractors.</p> Estimated Quantity of Work : _____ Date & Time Inspection Required : _____ Contractor Signature : _____ Date & Time _____ Received By : _____ Date & Time _____ C.C.: Owner Rep: _____ Date & Time _____ <p style="text-align: center; font-weight: bold; margin-top: 5px;">(All request must be submitted at least 24 hours prior to the required inspection)</p>	
Reply: <u>The above is Approved/Not approved for the following :-</u> <hr/> <hr/> <hr/> <hr/> <hr/> <hr/> <hr/> <hr/> <hr/> <hr/>	
Inspected by _____ Date & Time _____ Resident Engineer _____ Date & Time _____ Received by Contractor _____ Date & Time _____ C.C.: Owner Rep: _____ Date & Time _____	

FIGURE 4.76
Checklist for general works to be inspected.

Project Name
Consultant Name

NON-CONFORMANCE REPORT
NO. []

CONTRACTOR: _____ **DATE :**

/	/	
---	---	--

CONTRACT NO: _____

Location of Non-Conformance : _____

Drawing / Specification : _____

SAMPLE FORM

Description of Non-Conformance : _____

Resident Engineer : _____

Corrective / Preventive Action : (Proposed by Contractor)

Quality Control Engineer : _____

Contractor Manager: _____ **Date:** _____

Comments:

Resident Engineer: _____ **Date:** _____

FIGURE 4.78
Nonconformance report.

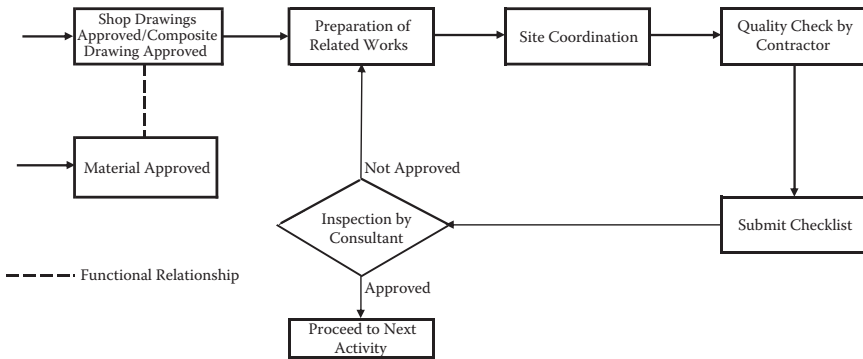

FIGURE 4.79
Sequence of execution of works.

fully coordinating with different trades. Figure 4.79 shows the sequence of execution of work.

Following this sequence will help the contractor avoid rejection of works. Rejection of the checklist will result in rework, which will require time to redo the works and has cost implications to the contractor. Frequent rejection of works may delay the project, ultimately affecting the overall completion schedule. Table 4.15 summarizes the probable reasons for rejection of executed/installed works.

Table 4.16 shows the responsibilities matrix for QC-related personnel.

PDCA is a well-known tool for continual process improvement. The contractor may use the PDCA cycle (Deming Wheel) principle to improve the construction/installation process and avoid rejection of works by the supervision team (consultant). Figure 4.80 illustrates the PDCA cycle for execution/installation of works.

4.5.6.3 Contractor’s Quality Control Plan

The contractor’s quality control plan (CQCP) is the contractor’s everyday tool to ensure meeting the performance standards specified in the contract documents. The efficient management of CQCP by the contractor’s personnel has a great impact on both the performance of the contract and the owner’s quality assurance surveillance of the contractor’s performance.

According to Chung (1999): “A quality plan is a document setting out the specific quality activities and resources pertaining to a particular contract or project. Its contents are drawn from the company’s quality system, the contract and related documents” (p. 45).

Chung further states that the quality plan is virtually a quality manual tailor-made for the project. The client, or the architect/engineer acting as his or her representative, may indicate in the contract what the quality plan must

TABLE 4.15

Reasons for Rejection of Executed Works

Serial No.	Description of Work	Probable Reasons for Rejection
<i>Shoring</i>		
1	Shoring	No adequate support for shoring. Vertical plumb level not proper. No proper bracing. Not enough depth. Anchor test not approved.
2	Dewatering	Water level not under control.
<i>Earthworks</i>		
1	Excavation	Not per specified level. Surface is not even. Excavated material not removed from the site.
2	Backfilling	Compaction is not proper. Backfilling thickness is not as specified. Soil is rubbish and loose. Soil test (strength) failed.
<i>Concrete substructure</i>		
1	Blinding concrete	Thickness not as specified. Concrete strength not as specified.
2	Termite control	Uneven spray.
3	Reinforcement of steel	Reinforcement arrangement not as specified. Support not proper. Water stops are not provided. Construction joints are not provided.
4	Concrete casting	Concrete strength not as specified.
5	Shuttering for beams and columns	Shuttering dimensions not as specified. Shuttering is not strong enough. Shutters are not vertical. Shuttering height not proper.
<i>Concrete superstructure</i>		
1	Reinforcement of steel for beams and columns	Reinforcement arrangement not as specified. Support not proper.
2	Shuttering for columns and beams	Shuttering dimensions not as specified. Shuttering is not strong enough. Shutters are not vertical. Shuttering height not proper.
3	Concrete casting of beams and columns	Concrete strength not as specified.
4	Formwork for slab	Props spacing not correct. Props are not sturdy. Formwork surface is not clean.
5	Reinforcement for slab	Reinforcement arrangement not as specified. Reinforcement is not properly placed and secured. Spacers, or minimum concrete cover, or construction joints are not provided.
6	Concrete casting of slab	Concrete strength not as specified. Casting level is not proper.
7	Precast panels	Panels are not fixed properly. Load test on panel not performed before erection.

TABLE 4.15 (Continued)

Reasons for Rejection of Executed Works

Serial No.	Description of Work	Probable Reasons for Rejection
<i>Masonry</i>		
1	Block work	Block alignment is not proper. Joints are not aligned. Guidelines are missing. Anchor beads are not provided. Reinforcement mesh is not provided. Mortar is not as specified.
2	Concrete unit masonry	Block alignment is not proper. Joints are not aligned. Reinforcement mesh is not provided. Mortar is not as specified.
<i>Partitioning</i>		
1	Installation of frames	Stud spacing not correct. Fixation method is not as specified. Insulation is not provided.
2	Installation of panels	Alignment not proper. Joints are not proper. Panels are not painted.
<i>Metalwork</i>		
1	Structural steel work	Anchorage and fixing not proper. Method of erection not as specified. Fire protection is not applied. Finishing is different than specified.
2	Installation of cat ladders	Fixation is not proper. Alignment is not done. Finishing is not as specified.
3	Installation of balustrade	Fixation is not proper. Alignment is not done. Finishing is not as specified.
4	Installation of space frame	Fixation is not proper. Alignment is not done. Finishing is not as specified.
5	Installation of handrails and railings	Fixation is not proper. Alignment is not done. Finishing is not as specified.
<i>Thermal and moisture protection</i>		
1	Applying waterproofing membrane	Number of layers not as specified. There is no overlap between the rolls. Application not done properly. No. of coats per specs not applied. There is no skirting. Leakage test failed.
2	Installation of insulation	Fixation is not proper. Insulation thickness is not as specified.
<i>Doors and windows</i>		
1	Aluminum windows and doors	Dimensions are not as specified. Accessories and hardware are different than specified. Windows are not air/water tight and not sealed properly. Doors are not opening properly.
3	Glazing	Color and type is different than specified. Fixing method is not proper. Cracks are observed in some of the units.
4	Steel doors and windows	Alignment not proper. Hardware and accessories not as specified. Finishing is not proper.
5	Wooden frames	Dimensions are different. Finishing is not as specified.

(Continued)

TABLE 4.15 (Continued)

Reasons for Rejection of Executed Works

Serial No.	Description of Work	Probable Reasons for Rejection
6	Wooden doors	Alignment not proper. Finishing is not as specified. Fixation hardware is not as specified.
7	Curtain wall	Pattern is not as specified. Glazing is different than specified. Drainage system is not provided. Expansion joints not provided. Wind pressure and water test failed.
8	Hatch doors	Door is not aligned. Finishing is not matching per architectural requirements. Fixing is not proper.
9	Louvers	Alignment and levels not proper. Accessories not as specified.
<i>Internal finishes</i>		
1	Plastering	Cracks in the plaster. Voids are observed. Specified accessories not used. Hollow sound observed. Curing is not enough.
2	Painting	Number of layers not as specified. Color and texture is not proper.
3	Cladding-ceramic	Alignment, angles and joints are not proper. Grouting is not done properly. Color and texture pattern do not match.
4	Cladding-marble	Fixation is not proper. Alignment, angles and joints are not proper. Lines are not matching.
5	Ceramic tiling	Alignment, angles and joints are not proper. Grouting is not done properly. Color and texture pattern is not matching.
6	Stone flooring	Fixation is not proper. Alignment, angles and joints are not proper.
7	Acoustic ceiling	Suspension system is not as specified. Alignment, levels and joints are not proper. Services openings are not provided. Ceiling height not matching with approved level.
8	Demountable partitions	Fixation is not proper. Alignment is not done properly.
<i>Furnishing</i>		
1	Carpeting	Joints are not smooth. Carpet fixed without adhesive. Edges are not trimmed properly. Color and texture not matching.
2	Blinds	Stacking/rolling not proper. Fixing is not secured.
3	Furniture	Location is not per approved layout. Dimensions are not correct. Finishing is not proper. Fixation is not secured properly. Accessories are not matching with the furniture.
<i>External finishes</i>		
1	Painting	Number of layers not as specified. Color and texture is not proper.
2	Brickwork	Brick alignment is not proper. Joints are not aligned. Grouting is not proper.
3	Stone	Fixation is not proper. Alignment, angles and joints are not proper. Color and texture not matching.
4	Cladding-aluminum	Alignment is not proper. Cladding is not leveled and aligned. Fixation is not secured. Joints are without sealant.

TABLE 4.15 (Continued)

Reasons for Rejection of Executed Works

Serial No.	Description of Work	Probable Reasons for Rejection
5	Cladding-granite	Fixation is not proper. Alignment, angles and joints are not proper. Color and texture do not match.
6	Curtain wall	Accessories are not properly fixed. Leveling and alignment not done. Drainage system is not provided. Wind pressure and water tests failed.
7	Glazing	Glass type is different than specified and approved. Fixation is not secured. Leveling and alignment not done properly. Joints have gap. Frame finishing is not per approved sample.
<i>Equipment</i>		
1	Installation of maintenance equipment	Brackets are not fixed at specified location.
2	Installation of kitchen equipment	Equipment are not fixed per approved layout.
3	Installation of parking control	Barrier is not fixed at specified location. Control panel is not terminated.
<i>Roof</i>		
1	Parapet wall	Parapet level is not correct. Finishing is not as specified.
2	Thermal insulation	Type of insulation and thickness is different than specified.
3	Waterproofing	Number of layers is less than specified. Application is not smooth. There is no overlap between the sheets. Skirting is not provided. Water test failed.
4	Roof tiles	Thickness of tiles is less than specified. Tiles are not aligned and leveled. Joints are not proper.
5	Installation of drains	Drains are not located per approved shop drawings. Fixation is not proper.
6	Installation of gutters	Type of gutters is different than specified. Gutters are not aligned and leveled.
<i>Elevator system</i>		
1	Installation of rails	Fixation is not proper.
2	Installation of door frames	Frame is not aligned properly.
3	Installation of cabin	Cabin is not leveled.
4	Cabin finishes	Cabin finishes are incomplete.
5	Installation of wire rope	Rope joints are weak.
6	Installation of drive machine	Drive is leveled properly. Equipment earthing is not done.

(Continued)

TABLE 4.15 (Continued)

Reasons for Rejection of Executed Works

Serial No.	Description of Work	Probable Reasons for Rejection
7	Installation of controller	Location of controller is not proper. Controller is not terminated. Equipment earthing is not provided. Identification label is not provided.
<i>HVAC works</i>		
1	Installation of piping	Hanger supports are not properly fixed. Invert level is not correct. Piping is rusty, not clean, and not painted.
2	Installation of ducting	Duct level not correct. Duct metal not clean. Suspension system not properly fixed. No proper sealant around duct joints.
3	Installation of insulation	Insulation has cuts. Straps not fixed at specified interval.
4	Installation of dampers, grills, and diffusers	Material is squeezed. Color is faded. Material not matching with architectural requirements.
5	Installation of cladding	Cladding surface is not even. Cladding is not overlapped and sealed properly.
6	Installation of fans	Fans fixing is not secured
7	Installation of fan coil units (FCU)	FCU level not correct. FCU fixed without spring isolators. No slope for drain pipe.
8	Installation of air handling units (AHU)	No flexible connector between chilled water piping and AHU. AHU body is damaged. Body paint is peeled off.
9	Installation of pumps	Pumps are not leveled. Cable termination not complete. Equipment earthing not done.
10	Installation of chillers	Rubber isolators not installed. Anchorage not fixed properly.
11	Installation of cooling towers	Vibration springs not installed. Damage in cooling tower surface. Spray nozzle damaged
12	Installation of thermostat and controls	Location not as specified. Thermostat body damaged.
13	Installation of starters	Location to be near the equipment. Installation height not as specified.
14	Building management system (BMS)	All the components not installed. Termination not complete. Wiring not dressed and bunched properly.
<i>Mechanical works</i>		
A. Water supply		
1	Installation of piping system	Pipe supports required to keep the pipe in straight position.
2	Installation of pumps	Pumps are not leveled. Cable termination not complete. Equipment earthing not done.

TABLE 4.15 (Continued)

Reasons for Rejection of Executed Works

Serial No.	Description of Work	Probable Reasons for Rejection
3	Filter units	Filter installed without bypass line and tab point for pressure gauge.
4	Toilet accessories	Towel rod not fixed.
5	Installation of insulation	Insulation has cuts. Insulation is not covered with canvas.
6	Water heaters	Water heater drain not installed.
7	Hand dryers	Installation height is more than specified. Termination is not proper.
8	Water tank	Float switch for pump not installed.
B. Drainage system		
1	Installation of pipes below grade	Drainage pipe to be tightened properly. Slope not proper.
2	Installation of pipes above grade	Slope not proper. More support is required.
3	Installation of manholes	Manhole level is not correct.
4	Installation of clean out, floor drains	Floor drains and clean out are not flush with the floor finish.
5	Installation of sump pumps	Height of float switch need adjustment.
6	Installation of gratings	Grating frame not flush with floor finish level.
C. Irrigation system		
1	Installation of piping system	Pipe crossing under road needs sleeves.
2	Installation of pumps	Pumps installed without suction strainer.
3	Installation of controls	Controllers are not weatherproof. Installation height is not proper. Fixing method is not proper.
D. Firefighting system		
1	Installation of piping system	Pipes are dirty, need cleaning and painting.
2	Installation of sprinklers	Sprinkler spacing not per authorities' approved shop drawing.
3	Installation of foam system	Foam agent concentration level not proper.

(Continued)

TABLE 4.15 (Continued)

Reasons for Rejection of Executed Works

Serial No.	Description of Work	Probable Reasons for Rejection
4	Installation of pumps	Eccentric reducer needs to be fixed at the suction side of the pump. Pumps are not leveled. Cable termination not complete. Equipment earthing not done.
5	Installation of hose reels/cabinet	Cabinet door not closing properly. Color of cabinet to be per authorities' requirement.
6	Installation of fire hydrant	Fire hydrant to be fixed properly at specified location.
7	External fire hose cabinet	External fire hose cabinet needs hose rack.
<i>Electrical works</i>		
1	Conduiting—Raceways	Method of installation not proper. Conduit run is not parallel. Minimum clearance from other services less than specified. Supports are not secured, straps or clamp not provided. Spacing between embedded conduit and concrete aggregate is not as specified. Fastening of conduit with reinforcement steel is not secured. Location of sleeves not per approved shop drawings. Location of boxes is not as specified and is not coordinated.
2	Cable tray—Trunking	Cable trays are not aligned properly. Cable tray run is not parallel and no proper bends. Supports are not per approved shop drawings. Minimum spacing between any cable tray and other services not maintained. Supports are not secured.
3	Floor boxes	Location is not coordinated. Level of floor boxes is not proper.
4	Wiring	No. of wires in the conduit are not per approved shop drawing. Circuit wiring for switches not properly done. Termination method is not proper.
5	Cabling	Distance between two cables on cable tray is less than twice the diameter of largest cable diameter. Cable tie is not provided. Circuit identification is missing.
6	Installation of bus duct	Supports are not fixed properly. Connection between the ducts is not proper. Level of installation is not as specified. Spacing between parallel is less than specified. Supports are not secured.
7	Installation of wiring devices/accessories	Installation height is not as specified, coordination with architectural requirements not done to match with the finishes.
8	Installation of light fittings	Installation method is not correct. Proper size of hangers and support not provided. Location and levels are not matching with architectural requirements.
9	Grounding	Welding method for joining tapes is not thermoweld type. Connection methods between tape and clamp to be as specified. Provide clamp at specified distance.

TABLE 4.15 (Continued)

Reasons for Rejection of Executed Works

Serial No.	Description of Work	Probable Reasons for Rejection
10	Distribution switchboards	Installation height of boards not as specified. Termination of wires/cables not done properly. Shrouding for cable not provided. Wires and cables do not have continuity. Wires in distribution board is not properly dressed and bunched.
<i>Fire alarm system</i>		
1	Installation of detectors, bells, pull stations, interface modules	Location is not as specified. Height of installation not matching with shop drawing and architectural requirements.
2	Installation of repeater panel	Installation height not as specified. Method of installation not proper. Termination of cables is not done.
3	Installation of mimic panel	Installation height not as specified. Method of installation not proper. Termination of cables is not done.
4	Installation of fire alarm panel	Installation height not as specified. Method of installation not proper. Termination of cables is not done.
<i>Telephone/communication system</i>		
1	Installation of racks	Method of installation not per approved shop drawing. Termination of cables not done properly. Racks are not leveled. Cables are not labeled.
2	Installation of switches	Switches are not properly installed. Switches are not installed in sequence. Cabling is not complete. Identification label not provided for cables.
<i>Public address system</i>		
1	Installation of speakers	Fixing of speakers is not secured. Height of installation is not as specified. Speakers installed in false ceiling do not have proper support.
2	Installation of racks	Method of installation not per approved shop drawing. Termination of cables not done properly. Racks are not leveled. Cables are not labelled.
3	Installation of equipment	Equipment are not properly installed. Cabling is not proper.
<i>Audiovisual system</i>		
1	Installation of speakers	Fixing of speakers is not secured. Height of installation is not as specified. Speakers installed in false ceiling do not have proper support.
2	Installation of monitors/screens	Method of fixing nor proper. Installation height is not per approved shop drawings.
3	Installation of racks	Method of installation not per approved shop drawing. Termination of cables not done properly. Racks are not leveled. Cables are not labelled.

(Continued)

TABLE 4.15 (Continued)

Reasons for Rejection of Executed Works

Serial No.	Description of Work	Probable Reasons for Rejection
4	Installation of equipment	Equipment are not properly installed. Cabling is not proper.
<i>CCTV/security system</i>		
1	Installation of cameras	Fixing of cameras not proper. Installation height is not as specified. Termination of cameras not proper.
2	Installation of panels	Panels not properly fixed. Cabling not complete.
3	Installation monitors/screens	Method of fixing nor proper. Installation height is not per approved shop drawings.
<i>Access control</i>		
1	Installation of RFID proximity readers, fingerprint readers	Readers not installed properly.
2	Installation of magnetic locks, release buttons, door contacts	Magnetic locks not fixed properly. Release buttons not installed at specified height and location.
3	Installation of panel	Panels not properly fixed. Cabling not complete.
4	Installation of server	Cable termination not proper. Cables to be properly dressed. Identification labels not provided.
<i>System integration</i>		
1	Installation of switches	Switches not stacked per sequence. Identification labels not provided.
2	Installation of servers	Cable termination not proper. Cables to be properly dressed. Identification labels not provided.
<i>External works</i>		
1	Site work	Compaction failure. Grading level not proper. Slope is not provided.
2	Asphalt work	Asphalt levels not proper. Asphalt material not as specified.
3	Pavement work	Pavement limits not per approved layout. Curb stones not laid properly.
4	Piping work	Pipe not laid at specified depth. No protection on pipes. Pipe joints not done well. Leakage observed.
5	Electrical work	Cable not buried properly. Location of light poles not correct. Light poles are not vertically installed.
6	Manholes	Location of manholes not correct. Manhole level not correct.
7	Road marking	Marking color not as specified.

TABLE 4.16
Responsibility for Site Quality Control

Serial No.	Description	Linear Responsibility Chart											
		Owner/Project Manager					Contractor						
		Owner/Project Manager	Consultant/Designer	Contractor Manager	Quality Incharge	Quality Engineers	Site Engineers	Safety Officer	Head Office				
1	Specify quality standards	<input type="checkbox"/>	<input checked="" type="checkbox"/>										
2	Prepare quality control plan			<input type="checkbox"/>	<input checked="" type="checkbox"/>			<input type="checkbox"/>					<input type="checkbox"/>
3	Control distribution of plans and specifications			<input type="checkbox"/>	<input checked="" type="checkbox"/>			<input type="checkbox"/>					<input type="checkbox"/>
4	Submittals			<input checked="" type="checkbox"/>		<input type="checkbox"/>			<input checked="" type="checkbox"/>				
5	Prepare procurement documents			<input type="checkbox"/>					<input checked="" type="checkbox"/>				<input checked="" type="checkbox"/>
6	Prepare construction method procedures			<input type="checkbox"/>		<input type="checkbox"/>			<input type="checkbox"/>		<input checked="" type="checkbox"/>		
7	Inspect work in progress		<input checked="" type="checkbox"/>										<input type="checkbox"/>
8	Accept work in progress		<input checked="" type="checkbox"/>										

(Continued)

TABLE 4.16 (Continued)
Responsibility for Site Quality Control

Serial No.	Description	Linear Responsibility Chart													
		Owner					Contractor								
		Owner/ Project Manager	Consultant/ Designer	Contractor/ Manager	Quality Incharge	Quality Engineers	Head Office	Safety Officer	Site Engineers	Quality Engineers	Head Office				
9	Stop work in progress	■	□												
10	Inspect materials upon receipt		■	□	■								■		
11	Monitor and evaluate quality of works		■	□	■	■				■			■		
12	Maintain quality records			□		■									
13	Determine disposition of nonconforming items	□	□	■											
14	Investigate failures	□	□	■	■					□			■		
15	Site safety			□											■

Note: ■ = Primary responsibility; □ = Advise/assist

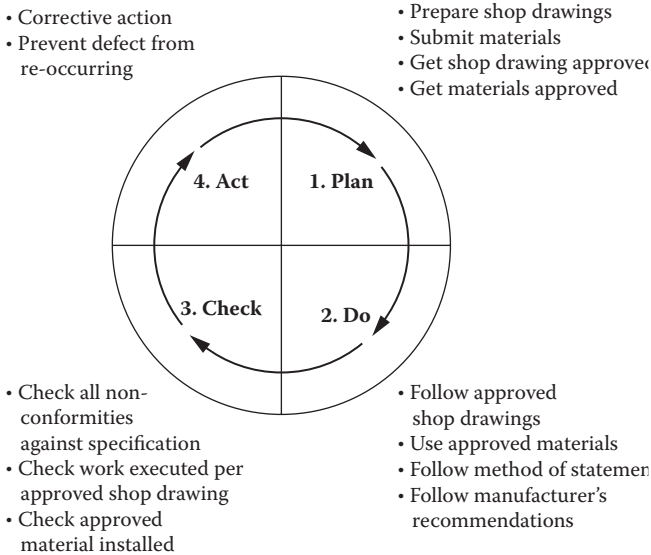

FIGURE 4.80
PDCA cycle for execution of works.

include and which items are subject to mutual agreement. For example, it is often specified that the inspection and test plans, which invariably form part of the quality plan, are to be approved by the architect/engineer before use.

The CQCP is the documentation of the contractor’s process for delivering the level of construction quality required by the contract. It is a framework for the contractor’s process for achieving quality construction. The CQCP does not endeavor to repeat or summarize contract requirements. It describes the process that the contractor will use to ensure compliance with the contract requirements. The quality plan is virtually a manual tailor-made for the project and is based on the contract requirements.

In the quality plan, the generic documented procedures are integrated with any necessary additional procedures peculiar to the project to attain specified quality objectives. Application of various quality tools, methods, and principles at different stages of construction projects is necessary to make the project qualitative, economical, and capable of meeting the owner’s needs/specification requirements.

Based on contract requirements, the contractor prepares his quality control plan and submits it to the consultant for approval. This plan is followed by the contractor to maintain project quality.

The contractor’s quality control plan is prepared based on the project-specific requirements as specified in the contract documents. The plan outlines the procedures to be followed during the construction period to attain the specified quality objectives of the project while fully complying with the contractual and regulatory requirements.

Appendix C illustrates an outline of a contractor's quality control plan for a major building construction project. However, the contractor has to take into consideration the requirements listed under the contract documents, depending on the nature and complexity of the project.

4.5.6.4 Site Safety

The construction industry has been considered to be dangerous for a long time. The nature of work at site always presents some dangers and hazards. There are a relatively high number of injuries and accidents at construction sites. Safety represents an important aspect of construction projects. Every project manager tries to ensure that a project is completed without major accidents on the site.

The construction site should be a safe place for those working there. Necessary measures are always required to ensure safety of all those working at construction sites. Effective risk control strategies are necessary to reduce and prevent accidents.

Contract documents normally stipulate that the contractor, upon signing the contract, has to submit a safety and accident prevention program. It emphasizes that all personnel have to put in efforts to prevent injuries and accidents. In the program, the contractor has to incorporate safety and health requirements of local authorities, manuals of accident prevention in construction, and all other local codes and regulations. A safety violation notice is issued if the contractor or any of his subcontractors are not complying with safety requirements. Figure 4.81 illustrates a safety violation report, on the basis of which action has to be taken by the contractor.

Penalties are also imposed on the contractor for noncompliance with the site safety program. The safety program shall embody the prevention of accidents, injury, occupational illness, and property damage. The contract specifies that a safety officer is engaged by the contractor to monitor safety measures. The safety officer is normally responsible for

1. Conducting safety meetings
2. Monitoring on-the-job safety
3. Inspecting the work and identifying hazardous areas
4. Initiating a safety awareness program
5. Ensuring availability of first aid and emergency medical services per local codes and regulations
6. Ensuring that personnel are using protective equipment such as hard hat, safety shoes, protective clothing, life belt, and protective eye coverings
7. Ensuring that the temporary firefighting system is working
8. Ensuring that work areas are free from trash and hazardous material
9. Housekeeping

1. Unsafe access
2. Ladders
3. No barricades around excavated areas, trenches, openings, holes, and platforms
4. No barricades/railings on the stairs
5. Scaffolding
6. Lifting gear
7. Crane
8. Hoist
9. Welding
10. Hand and power tools
11. Poor lighting
12. Fire

The following are general safety guidelines the contractor may follow to avoid accidents/injuries:

1. Ensure safe access.
2. Ensure that ladders are in good condition and properly secured.
3. Provide barricades around openings, holes, and platforms.
4. Choose the right system of scaffolding for the job to be performed.
5. Check lifting gears for capacity, condition of wire rope, slings, hooks, eyebolts, shackles, proprietary lighting equipment, and spreader beam.
6. Ensure that the crane is
 - a. On firm, level ground and outriggers are fully extended.
 - b. Operating with a safe working load.
 - c. Working with minimum load swing.
 - d. Operating with the right type of chain.
 - e. Working with the load kept clear of personnel.
7. The hoist is certified by a third party, and the certificate is valid.
8. Wear all protective equipment and garments necessary to be safe on the job.
9. Wear and use eye protection coverings.
10. Use safety shoes.
11. Use hard hats.
12. Use safety belts.
13. Use respiratory masks whenever required.
14. Use the right size of hand tools.

15. Before using any plant or mechanized equipment, check that it is certified for safe operation.
16. Before using electric tools:
 - a. Check that it is properly earthed.
 - b. Ensure that cable, plugs, or connectors are in sound condition and properly wired up.
17. Use proper guards while using power tools such as circular saws, portable grinders, and bench grinders.
18. Use safe loading/unloading techniques.
19. All material stored at site should be stacked properly to ensure that it is stable and secured against sliding or collapse.
20. Work areas and means of access should be maintained in a safe and orderly condition.
21. Mark access and escape routes.
22. Keep passageways and accessways free from materials, supplies, and obstructions all the time.
23. Mark all the hazardous areas.
24. Prohibit storage of flammable and combustible material.
25. "No smoking" sign to be displayed.
26. Install sirens and alarm bells at site.
27. Ensure that the temporary firefighting system is working all the time.
28. All formwork, shoring, and bracing should be designed, fabricated, erected, supported, braced, and maintained so that it will safely support all vertical and lateral loads that might be applied, until such loads can be supported by the structure.
29. While placing concrete:
 - a. Make use of protective clothing and equipment.
 - b. Use appropriate gloves.
 - c. Use rubber boots.
 - d. Wear protective goggles.
 - e. Take necessary precautions while using concrete skips or concrete.
30. Display safety signs such as DANGER, CAUTION, and WARNING on all live electrical panels.
31. Post safety, warning signs, and notices of weekly project safety record.
32. Conduct "Safety Awareness" programs.

The contractor is responsible for ongoing maintenance of accident/incident records on the construction site and their notification to the consultant. Figure 4.82 shows an accident-reporting form.

Project Name	
ACCIDENT REPORT	
CONTRACT : _____	CONTRACT NO. : _____
CONTRACTOR : _____	REPORT # : _____
SUBCONTRACTOR : _____	REPORT DATE : _____
SAMPLE FORM	
ACCIDENT DATE	_____
ACCIDENT TIME	_____
ACCIDENT LOCATION	_____
INJURED PERSON	I.D.# _____
ADDRESS	AGE _____
ACCIDENT DETAILS :	_____
- CAUSE	_____
- PERSONAL INJURY	_____
- PROPERTY DAMAGE	_____
ACCIDENT REPORTED BY	I.D.# _____
ACCIDENT REPORTED TO	I.D.# _____
WITNESSED BY	I.D.# _____
INVESTIGATED BY	I.D.# _____
ACTION TAKEN :	_____
- MEDICAL AID	_____
- FOLLOW UP	_____
- LEGAL ACTION	_____
NOTE : IDENTIFY ENTRY PASS NUMBERS FOR ALL INDIVIDUALS INVOLVED	
_____ CONTRACTOR REP. SIGNATURE.	

FIGURE 4.82
Accident report.

TABLE 4.17

The 5S Concept

Japanese	English Equivalent	Stands For
Seiri	Sort	<ul style="list-style-type: none"> ■ Keeping only essential items ■ Sort out necessary from unnecessary and discard the unnecessary
Seiton	Set in order/ simplify	<ul style="list-style-type: none"> ■ Keep items in a systematic/orderly manner to enable easy traceability
Seiso	Shine/sweep	<ul style="list-style-type: none"> ■ Maintain cleanliness by arranging articles in dirt-free and tidy surroundings, so that they are ready to use
Seiketsu	Standardize	<ul style="list-style-type: none"> ■ Keep work area organized for consistent and standardized operation
Shitsuke	Sustain	<ul style="list-style-type: none"> ■ Maintain what has been accomplished

4.5.6.5 5S for Construction Projects

5S is a systematic approach for improving quality and safety by organizing a workplace. It is a methodology that advocates

- What should be kept
- Where it should be kept
- How it should be kept

5S is a Japanese concept of housekeeping having reference to five Japanese words starting with letter S. Table 4.17 shows these words with their English equivalent words and what these words stand for.

Construction projects are temporary workplaces. Construction project materials are stored in both covered as well as in open areas. The contractor has to keep all the material in the available space in neat and clean ready-to-use condition. The area should be safe and risk free for free movement of the work personnel. The contractor has to consider site safety while arranging the storage area.

The contractor is responsible for providing all the resources to build the project/facility. These resources are mainly

1. Manpower
2. Construction equipment, machinery, and tools
3. Material to be used/installed in the project
4. Consumables

The following points have to be considered while planning the layout for storage of construction material:

1. Construction documents specify the minimum number of construction equipment, machinery, and tools to be made available at the construction site during the construction process.
2. Materials to be used/installed in the project are documented in the bill of quantity (BOQ) or bill of material (BOM), and contract drawings and documents.
3. Consumables are required by the contractor to fabricate/install/assemble the equipment/panel/material.

Table 4.18 shows an example of how a 5S program can be developed for construction projects.

The 5S program helps

- Reduce time to search equipment, tools, material, and consumables
- Improve activity timing
- Increase space for storage
- Improve safety
- Organize the workplace

4.5.7 Inspection

The inspection of construction work is performed throughout the execution of project. Inspection is an ongoing activity to physically check the installed works. Checklists are submitted by the contractor to the consultant to inspect the executed work/installations. If the work is not carried out as specified, then it is rejected and the contractor has to rework, or take remedial measures, to ensure compliance with the specifications. During construction, all the physical and mechanical activities are accomplished on the site. The contractor carries out the final inspection of the work to ensure full compliance with the contract documents.

TABLE 4.18

5s for Construction Projects

Serial No.	5S	Related Action
1	Sort	<ul style="list-style-type: none"> ■ Determine what is to be kept in the open and what under shed ■ Allocate area for each type of construction equipment and machinery ■ Allocate area for electrical tools ■ Allocate area for hand tools ■ Allocate area for construction material/equipment to be used/installed in the project ■ Allocate area for hazardous, inflammable material ■ Allocate area for chemicals, paints ■ Allocate area for spare part for maintenance
2	Set in order	<ul style="list-style-type: none"> ■ Keep/arrange equipment in such a way that their maneuvering/movement shall be easy ■ Vehicles are to be parked in the yard in such a way that frequently used vehicles are parked near the gate ■ Frequently used equipment/machinery to be located near the workplace ■ Set boundaries for different type of equipment and machinery ■ Identify and arrange tools for easy access ■ Identify and store material/equipment per relevant division/section of contract documents ■ Identify and store material in accordance with their usage per construction schedule ■ Determine items that need special conditions ■ Mark/tag the items/material ■ Display route map and location ■ Put the material in sequence per their use ■ Frequently used consumables to be kept near workplace ■ Label drawers with list of contents ■ Keep shuttering material at one place ■ Determine inventory level of consumable items
3	Sweeping	<ul style="list-style-type: none"> ■ Clean site on daily basis by removing <ul style="list-style-type: none"> – Cut pieces of reinforced bars – Cut pieces of plywood – Left-out concrete – Cut pieces of pipes – Cut pieces of cables and wires – Used welding rods

(Continued)

TABLE 4.18 (Continued)

5s for Construction Projects

Serial No.	5S	Related Action
		<ul style="list-style-type: none"> – clean equipment and vehicles – check electrical tools after return by the technician – attend to breakdown report
4	Standardize	<ul style="list-style-type: none"> ■ Standardize the store by allocating separate areas for material used by different divisions/sections ■ Standardize area for long lead items ■ Determine regular schedule for cleaning the work place ■ Make available standard toll kit/box for a group of technicians ■ Make every one informed of their responsibilities and related area where the things are to be placed and are available ■ Standardize the store for consumable items ■ Inform suppliers/vendors in advance the place for delivery of material
5	Sustain	<ul style="list-style-type: none"> ■ Follow the system until the end of project

4.6 Testing, Commissioning, and Handover

Testing, commissioning, and handover is the last phase of a construction project's life cycle. This phase involves testing of electromechanical systems, commissioning of the project, obtaining authorities' approval, training user's personnel, handing over technical manuals, documents, and as-built drawings to the owner/owner's representative. During this period, the project is transferred/handed over to the owner/end user for his or her use, and a substantial completion certificate is issued to the contractor.

4.6.1 Testing

All work is checked and inspected on a regular basis while the construction is in progress; however, there are certain inspection and tests to be carried out by the contractor in the presence of the owner/consultant. These are especially for electromechanical systems, conveying systems, and electrically operated equipment, which are energized after connection of permanent power supply. Testing of all these systems starts after completion of installation works. By this time, the facility is connected to a permanent electrical power supply, and all the equipment is energized. Figure 4.83 illustrates the procedure followed in Kuwait to get power supply. (This procedure may vary from country to country.)

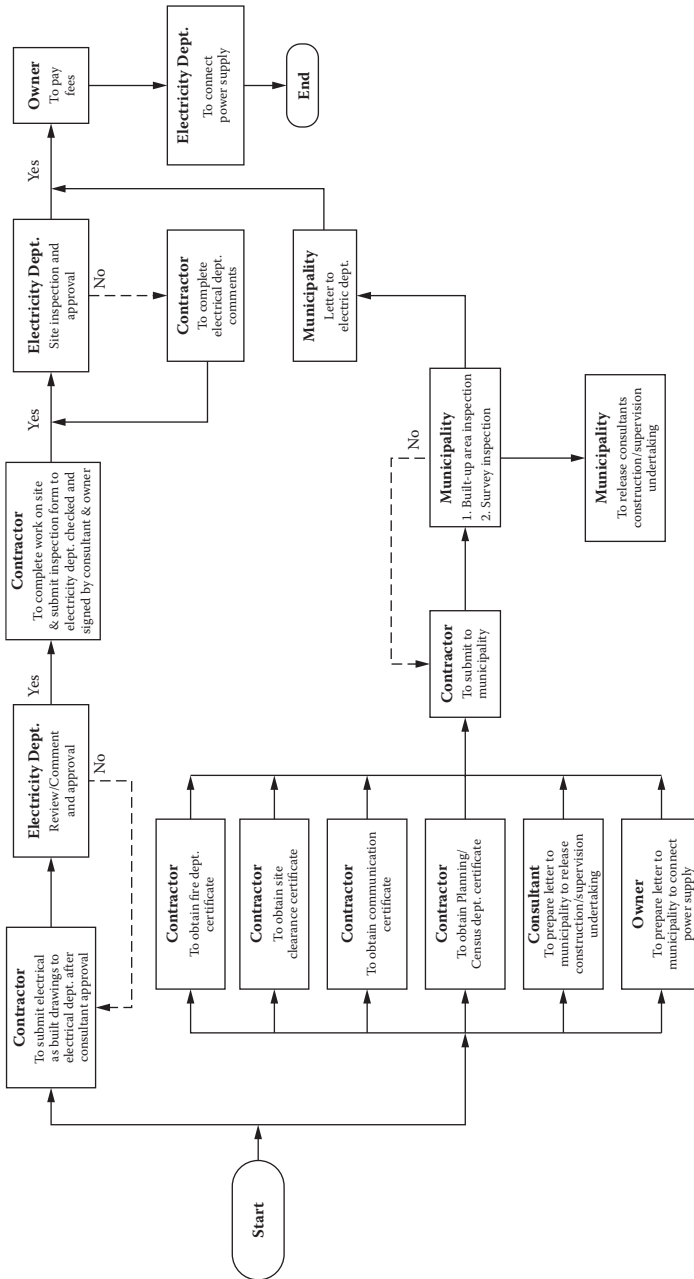

FIGURE 4.83 Electrical power supply connection procedure.

The authors of *Civil Engineering Procedure* (Institution of Civil Engineers 1996) have described inspection and testing of works as follows:

Inspection and Testing: During construction and on completion of parts of a project, inspection and testing are usually required in order to confirm compliance with the drawings and specification. Testing and inspection are generally required for static components of a project, while dynamic components such as machinery require testing and commissioning. The Project Manager or the Engineer, supported by his team, is usually responsible for inspection on and off-site and for testing of materials.

Test Criteria and Schedules: The performance tests and criteria to be applied to any aspect of work should be specified in the contract for that work as far as possible, so as to enable the identification of the state at which an acceptable quality or degree of completion has been achieved. Depending on the type of project, samples and mock-up or factory inspections and acceptance test may be required. If they are, the responsibility for their cost should be defined.

Schedules (lists) of the necessary inspections and tests should be agreed through collaboration between the Project Manager and all parties. (p. 105)

Testing is carried out mainly on electromechanical works/systems and electrically operated equipment, which are energized after connection of permanent power supply to the facility. These include the following:

1. HVAC system
2. Firefighting system
3. Water supply, plumbing, and public health system
4. Integrated automation system (building automation system)
5. Electrical lighting and power system
6. Grounding (earthing) and lightning protection system
7. Emergency power supply system
8. Fire alarm system
9. Telephone system
10. Communication system
11. Electronic security and access control system
12. Public address system
13. Conveying system
14. Electrically operated equipment

These tests are essential to ensure that each individual work/system is fully functional and operates as specified. These tests are normally coordinated and scheduled with specialist contractors, local inspection authorities, third-party

Project Name	
ON SITE TESTING OF ELECTRO-MECHANICAL WORKS	
CONTRACTOR : _____	CHECK LIST No. : <input type="text"/>
SUBCONTRACTOR: _____	DATE: <input type="text"/>
FOLLOWING WORKS ARE READY FOR INSPECTION ON: _____ TIME: _____	
<input type="checkbox"/> ELECTRICAL LOCATION: _____	<input type="checkbox"/> MECHANICAL DRAWING REF: _____
SPECIFICATION NO : _____	DIVISION : _____ SECTION : _____
SAMPLE FORM	
Description of Work/System: _____ _____ _____	
TEST PROCEDURE: YES <input type="checkbox"/>	NO <input type="checkbox"/>
METHOD STAEMENT: YES <input type="checkbox"/>	NO <input type="checkbox"/>
CONTRACTOR SIGNATURE: _____	DATE: _____
A/E REMARKS: _____ _____ _____	
CONSULTANT ENGINEER: _____	RESIDENT ENGINEER: _____
DATE: _____	DATE: _____
Distribution <input type="checkbox"/> OWNER <input type="checkbox"/> R.E. <input type="checkbox"/> CONTRACTOR	

FIGURE 4.84
Checklist for electromechanical work.

inspection authorities, and manufacturers’ representatives. Sometimes, the owner’s representative may accompany the consultant to witness these tests. Test procedures are submitted by the contractor along with the request for final inspection. Figure 4.84 is a request form for final inspection of electro-mechanical works.

4.6.2 Commissioning

Commissioning is the orderly sequence of testing, adjusting, and balancing the system and bringing the systems and subsystems into operation; it starts when the construction and installation of works are complete. Commissioning is normally carried out by the contractor or specialist in the presence of the consultant and owner/owner's representative and user's operation and maintenance personnel to verify proper functioning of the systems to the specified standards.

According to the authors of *Civil Engineering Procedure* (Institution of Civil Engineers 1996):

Commissioning is the orderly process of testing, adjustment and bringing the operational units of the project into use. It is generally required where systems and equipment are to be brought into service following installation. Commissioning may be carried out by the promoters or contractor's staff by specialist personnel or by a mixed team. For complex industrial projects, a commissioning manager is usually appointed by the promoter to plan the commissioning preferably early in the project, establish budgets, lead a commissioning team, and procure the other necessary resources. For simple projects, commissioning is usually undertaken by the contractor, subject to the approval of procedures by the promoter or engineer. The commissioning of familiar or small process and industrial facilities is usually carried out by the operator with the advice and assistance of the suppliers of the equipment and systems. (p. 106)

The commissioning of the construction project is a complex and intricate series of start-up operations, and may extend over many months. Testing, adjusting, and operation of the systems and equipment are essential in order to make the project operational and useful for the owner/end user. It requires extensive planning and preparatory work, which commence long before the construction is complete. All the contracting parties are involved in the start up and commissioning of the project as it is required for the project to be handed over to the owner/user.

4.6.3 Authorities' Approval

Necessary regulatory approvals from the respective concerned authorities are obtained so that owner can occupy the facility and start using/operating it. In certain countries, all such approvals have to be obtained before electrical power supply is connected to the facility. It is also required that the building/facility be certified by the related fire department authority/agency that it is safe for occupancy.

4.6.4 As-Built Drawings

Most contracts require the contractor to maintain a set of record drawings. These drawings are marked to indicate the actual installation where the

installation varies appreciably from installation shown in the original contract. Revisions and changes to the original contract drawings are almost certain for any construction project. All such revisions and changes are required to be shown on the record drawings. As-built drawings are prepared by incorporating all the modifications, revisions, and changes made during the construction. These drawings are used by the user/operator for reference purposes after taking over the project. It is a contractual requirement that the contractor hand over as-built drawings along with record drawings, record specifications, and record product data to the owner/user before handing over of the project and issuance of the substantial completion certificate. In certain projects, the contractor has to submit field records on excavation and underground utility services detailing their location and levels.

4.6.5 Technical Manuals and Documents

Technical manuals, design and performance specifications, test certificates, and warranties and guarantees of the installed equipment are required to be handed over to the owner as part of the contractual conditions.

According to the authors of *Civil Engineering Procedure* (Institution of Civil Engineers 1996):

The commissioning and handover stage is the point for finalizing the project documentation. There are three categories of documents to be handed over by designers, equipment suppliers, and contractors:

- Records of the equipment and services as installed
- Commissioning installations, including safety rules
- Operating and maintenance instructions, including safety rules

Generally the first category will include design and performance specifications, test certificates, snagging lists, as-built drawings and warranties. In addition to these, documentation for the commissioning and operation will include permits, certificates of insurance, operation and maintenance manuals and handover certificates. (p. 109)

Systems and equipment manuals submitted by the contractor to the owner/end user generally consist of

- Source information
- Operating procedures
- Manufacturer's maintenance documentation
- Maintenance procedure
- Maintenance and service schedules
- Spare parts list and source information
- Maintenance service contract
- Warranties and guarantees

The procedure for submission of all these documents is specified in the contract document.

4.6.6 Training of User's Personnel

Normally, training of user's personnel is part of the contract terms. The owner's/user's commissioning, operating, and maintenance personnel are trained and briefed before commissioning starts in order to familiarize the personnel about the installation works and also to ensure that the project is put into operation rapidly, safely, and effectively without any interruption. The timing and details of training vary widely from project to project. Training must be completed well in advance of the requirement to make the operating teams fully competent to be deployed at the right time during commissioning. This needs to be planned from project inception, so that the roles and activities of the commissioning and operating staff are integrated into a coherent team to maximize their effectiveness.

4.6.7 Handover of Facility to Owner/End User

Once the contractor considers that the construction and installation of works has been completed per the scope of contract, final tests have been performed, and all the necessary obligations have been fulfilled, the contractor submits a written request to the owner/consultant for handing over of the project and for issuance of substantial completion certificate. This is done after testing and commissioning is carried out, and it is established that the project can be put into operation or the owner can take charge of the project. In most construction projects, there is a provision for partial handover of the project.

The owner/consultant inspects the work and informs the contractor of unfulfilled contract requirements. A punch list (snag list) is prepared by the consultant listing all the items still requiring completion or correction. The list is handed over to the contractor for rework/correction of the works mentioned in the punch list. The contractor resubmits the inspection request after completing or correcting previously notified works. A final snag list is prepared if there are still some items that need corrective action/completion by the contractor; the remaining works are to be completed within the agreed period to the satisfaction of the owner/consultant.

The contractor starts handing over of all completed works/systems that are fully functional, and the owner agrees to take over the items handed over. A handing over certificate is prepared and signed by all the concerned parties. Figure 4.85 shows a handing over certificate.

Most contract documents include the list of spare parts, tools, and extra materials to be delivered to the owner/end user during the closeout stage of the project. The contractor has to properly label these spare parts and tools clearly indicating the manufacturer's name and model number if applicable. Figure 4.86 illustrates the spare parts handover form used by the contractor.

Project Name		
Project Name		
HANDING OVER CERTIFICATE		
CONTRACTOR : _____	CERTIFICATE No. <input style="width: 50px;" type="text"/>	
SUBCONTRACTOR: _____	DATE <input style="width: 50px;" type="text"/>	
SPECIFICATION NO : _____	DIVISION : _____	SECTION : _____
DRAWING No. _____	BOQ REF: _____	
AREA : <input type="checkbox"/> Building Works	<input type="checkbox"/> Electrical Works	<input type="checkbox"/> Mechanical Works
<input type="checkbox"/> HVAC Works	<input type="checkbox"/> Finishes Works	<input type="checkbox"/>
SAMPLE FORM		
Description of Work/System: _____		

<p>The work/system mentioned above is completed by the contractor as specified and has been inspected and tested as per contract documents. The work/system is fully functional to the satisfaction of owner/end user. The contractor hand over the said work/system the owner/end user as on -----. The guarentee/warranty of work/system shall start as of ----- and shall be valid for a period of -----years (duration) from the date of issuance of substantial completion certificate. The contractor shall be liat contractually till the end of warranty/guarentee period.</p>		

SIGNED BY:		
OWNER/END USER: _____	CONTRACTOR: _____	
CONSULTANT: _____	SUBCONTRACTOR: _____	

FIGURE 4.85
Handing over certificate.

4.6.8 Move-In Plan

No one wants to keep the facility unoccupied after completion of the construction project, and once it is declared fit for use/occupancy.

The move-in plan has been prepared based on the substantial completion of the facility or partial handover/taking over of the facility. With commercial facilities, the investor would like the tenant to occupy the building so that

Project Name
Project Name
HANDING OVER OF SPARE PARTS

CONTRACTOR: _____ CERTIFICATE No. :

SUBCONTRACTOR: _____ DATE

SPECIFICATION NO : _____ DIVISION _____ SECTION : _____

DRAWING No. _____ BOQ Ref. _____

AREA : Building Works Electrical Works Mechanical Works
 HVAC Works Finishes Works

Following Spare Parts have been handed over to the owner/end user

Description of Spare Parts

Sr.No.	Description	BOQ Reference	Spec. Ref.	Manufacturer	Specified Qty	Delivered Qty
SAMPLE FORM						

(Attach additional sheet,if required)

SIGNED BY:

OWNER/END USER: _____ CONTRACTOR: _____

CONSULTANT: _____ SUBCONTRACTOR: _____

FIGURE 4.86
Handing over of spare parts.

the substantial certificate normally used for building construction projects in Kuwait. Authorities' approval requirements mentioned in this figure may vary from country to country; however, other requirements need to be completed by the contractor for issuance of a substantial completion certificate.

Normally, a final walk-through inspection is carried out by a committee, which consists of the owner's representative, design and supervision personnel, and the contractor to decide the acceptance of works and whether the project is complete enough to be made operational. If there are any minor items remaining to be finished, then a list of such items is attached with the certificate of substantial completion for conditional acceptance of the project. Issuance of substantial completion certifies acceptance of the work. If the remaining work is of a minor nature, then the contractor has to submit a written commitment that he or she will complete the agreed-upon work within the stipulated period. A memorandum of understanding is signed between the owner and the contractor that the remaining works will be completed within the stipulated period.

Table 4.19 illustrates a list of activities that need to be considered for project closeout.

The certificate of substantial completion is issued to the contractor, and the facility is taken over by the owner/end user. By this stage, the owner/end user has already taken possession of the facility, and operation and maintenance of the facility commences. The project is declared complete, and the construction project's life cycle is over.

TABLE 4.19

Project Closeout Checklist

Serial No.	Description	Yes/No
<i>Project execution</i>		
1	Contracted works completed	
2	Site work instructions completed	
3	Job site instructions completed	
4	Remedial notes completed	
5	Noncompliance reports completed	
6	All services connected	
7	All the contracted works inspected and approved	
8	Testing and commissioning carried out and approved	
9	Any snags	
10	Is the project fully functional?	
11	All other deliverable completed	
12	Spare parts delivered	
13	Is waste material disposed?	
14	Whether safety measures for use of hazardous material are established	
15	Whether the project is safe for use/occupation	
<i>Project documentation</i>		
16	Authorities' approval obtained	
17	Record drawings submitted	
18	Record documents submitted	
19	As-built drawings submitted	
20	Technical manuals submitted	
21	Operation and maintenance manuals submitted	
22	Equipment/material warranties/guarantees submitted	
23	Test results/test certificates submitted	
<i>Training</i>		
24	Training to owner's/end user's personnel imparted	
<i>Payments</i>		
25	All payments to subcontractors/specialist suppliers released	
26	Bank guarantees received	
27	Final payment released to main contractor	
<i>Handing over/Taking over</i>		
28	Project handed over/taken over	
29	Operation/maintenance team taken over	
30	Excess project material handed over/taken over	
31	Facility manager in action	

5

Operation and Maintenance

5.1 Operation and Maintenance

Once the project is completed and fully functional, then it becomes part of the operation system. The operation and maintenance (O&M) of a completed project are associated with the quality of the constructed project.

The owner may employ the same contractor(s) who built the facility or engage another specialist operation and maintenance organization to manage the operation and maintenance. It is likely that the owner may have his own team to operate and maintain the facility. The following documents are required to operate and maintain the completed facility. These documents are normally submitted by the contractor during the testing, commissioning, and handover phase of the construction project.

1. As-built drawings
2. Operation and maintenance manuals
3. Operating procedures
4. Source information for availability of spare parts of the installed works

The cost of operation and maintenance should be considered in the feasibility studies of the project. Postconstruction costs have a great impact on the overall life cycle cost of the project.

5.2 Categories of Maintenance

Following are different types of maintenance normally being carried out, depending on the nature of activity, system, or equipment, to avoid interference/interruption with essential installation operations, endanger life or property, or involving high cost for replacement of the item.

5.2.1 Preventive Maintenance

Preventive maintenance is the planned, with scheduled periodic inspection, adjustment, cleaning, lubrication, parts replacement of equipment and systems in operation. Its aim is prevention of breakdown and failure. Preventive maintenance consists of many activities required to be checked and performed to ensure that the operations are safe and can be performed without any danger to life or facility and will not warrant high cost or long lead time for replacement. Preventive maintenance is the cornerstone of any good maintenance program.

5.2.2 Scheduled Maintenance

Scheduled maintenance includes those maintenance tasks whose cycles exceed a specified period. This type of maintenance relates to finish items, such as painting, polishing of wood, parking and road markings, roof maintenance, and testing of fire alarm systems.

5.2.3 Breakdown Maintenance

Breakdown maintenance for systems or equipment is scheduled and unanticipated because of system or component failure. If the problem relates to an essential service or has any hazardous effect, then an emergency response is necessary. If the problem is not critical, then routine response is adequate.

5.2.4 Routine Maintenance

Routine maintenance is an action taken by the maintenance team to restore a system or piece of equipment to its original performance, capacity, efficiency, or capability.

5.2.5 Replacement of Obsolete Items

Replacement of obsolete items refers to the work undertaken by a maintenance team to bring a system or component into compliance with new codes of safety regulations or to replace an item that is unacceptable, inefficient, or for which spare parts are no longer available or have had technological changes. Early detection of problems may reduce repair and replacement costs, prevent malfunctioning, and minimize downtime as, for example, with communication systems, audio visual systems, and equipment.

5.2.6 Predictive Testing and Inspection

Predictive testing and inspection refers to testing and inspection activities that involve the use of sophisticated means to identify maintenance requirements. For example, specialized tests are to be carried out:

- To locate wearing problems on bus bar bends of an electrical main's low tension panel
- To detect insulation cracks
- To locate thinning of pipe walls and cracks
- To identify vibration problems for equipment like chillers, diesel generator sets, pumps
- To locate heat buildup (rise in temperature) in electrical bus duct

5.3 O&M Program

Addressing operation and maintenance considerations at the start of the project contributes greatly to improved working environments, higher productivity, and reduced energy and resources costs. During the design phase of the project and up to handover of the facility, O&M personnel should be involved in identifying maintenance requirements for inclusion in the design. The goal of effective O&M is to achieve the intent of the original design team, i.e., the systems and equipment delivery services to the user enhancing a comfortable, healthy, and safe environment. O&M should also include long-term goals such as economy, energy conservation, and environmental protection. To create an effective O&M program, the following procedures should be followed:

- Ensure that up-to-date as-built drawings for all the systems are available
- Ensure that operational procedures and manuals for the installed equipment are available
- Prepare a master schedule for operation and preventive/predictive maintenance
- Implement preventive maintenance programs complete with maintenance schedules and records of all maintenance performed for all the equipment and systems installed in the project/facility
- Follow manufacturer's recommendations for maintenance of equipment and systems
- Ensure the maintenance personnel have full knowledge of the equipment and systems installed and for which he/she is responsible to operate and maintain
- Ensure that O&M personnel are provided training during the testing, commissioning, and handover phase
- Offer training and professional development opportunities for each of the O&M team members

- Implement a monitoring program that tracks and documents equipment performance to identify and diagnose potential problems
- Implement a monitoring program that tracks and documents systems performance to identify and diagnose potential problems
- Perform predictive testing and inspection for critical and important items
- Use preventive maintenance and standbys, etc. so that the failed components can be isolated and repaired without interrupting system performance, thus minimization of equipment failures

For an effective O&M program, the following specific items should be considered:

1. HVAC system and equipment
2. Indoor air quality system and equipment
3. Electrical systems and equipment
4. Water fixtures and system
5. Life safety (fire suppression systems)
6. Cleaning equipment and products
7. Landscape maintenance

A guideline to prepare a preventive maintenance program, taking into consideration the most important equipment and systems of an office/commercial building, is illustrated in Table 5.1.

TABLE 5.1
Preventive Maintenance Program

Serial No.	Activities	Maintenance Frequency				
		Daily	Weekly	Monthly	Quarterly	Yearly
	Chiller					
	Cooling tower					
	Air handling unit					
	Fan coil unit					
	Exhaust air fan					
	Supply air fan					
	Package unit					
	DX unit					
	Split unit					
	VAVs					
	Chilled water pump					
	Condenser water pump					
	Hot water pump					
	Domestic water pump					
	Booster pump					
	Sump pump (drainage pump)					
	Fire pumps					
	Jockey pump					
	Firefighting system					

(Continued)

TABLE 5.1 (Continued)

Preventive Maintenance Program

Serial No.	Activities	Maintenance Frequency				
		Daily	Weekly	Monthly	Quarterly	Yearly
	Foam system					
	Building automation system					
	Water boilers					
	Sanitary and water fixtures					
	Main low-tension panel					
	Main/sub-main switch boards					
	Electrical distribution boards					
	Bus duct					
	Automatic transfer switch					
	Diesel generator set					
	Fire alarm system					
	Communication system					
	Security system					
	Access control system					
	Audio visual system					
	Public address system					
	Dimmer system					

TABLE 5.1 (Continued)

Preventive Maintenance Program

Serial No.	Activities	Maintenance Frequency				
		Daily	Weekly	Monthly	Quarterly	Yearly
	Uninterrupted power supply (ups)					
	Cleaning equipment					
	Kitchen equipment					
	Elevator					
	Escalator					
	Landscape					

6

Facility Management

6.1 Facility Management

Facility management is the process by which an organization integrates all noncore specialist services to achieve strategic objectives. It enhances the performance of the organization. It is an integration of people, place, process, and technology.

Facility management is mainly applied to buildings/properties that are complex in nature, including more complex management and operation. Construction projects are becoming more sophisticated and more technical in nature; therefore, their performance has to be maintained and the level of services has to be improved to satisfy user needs.

Facility management is effectively managing physical assets of an organization to ensure their value is realized and their repair, maintenance, and replacement are planned in an economical manner. Facility management is a multidiscipline activity. It involves a number of disciplines and services. It encompasses multi-disciplinary activities within the built environment and the management of their impact upon people and the workplace. It covers the development, coordination, and development of all the noncore specialist services of an organization, together with the buildings and their systems, environment, equipment, plant, health and safety, information technology, infrastructure, landscape, and all the services. Figure 6.1 illustrates the areas covered under facility management.

Facility management is gaining increasing recognition among large organizations as an important factor for business improvement. Effective facilities management, combining resources and activities, is vital to the success of any organization. At a corporate level it contributes to the delivery of strategic and operational objectives. Facility management is a relatively new aspect in Asia and other developing countries. However, there has been an enormous growth in facility management activities worldwide. Table 6.1 summarizes facilities management market characteristics between Europe and the Middle East.

Operation and maintenance expenses are normal. However, the cost can be minimized through an aggressive facility management program and the use of applicable diagnostic tools. The key to success of facility management

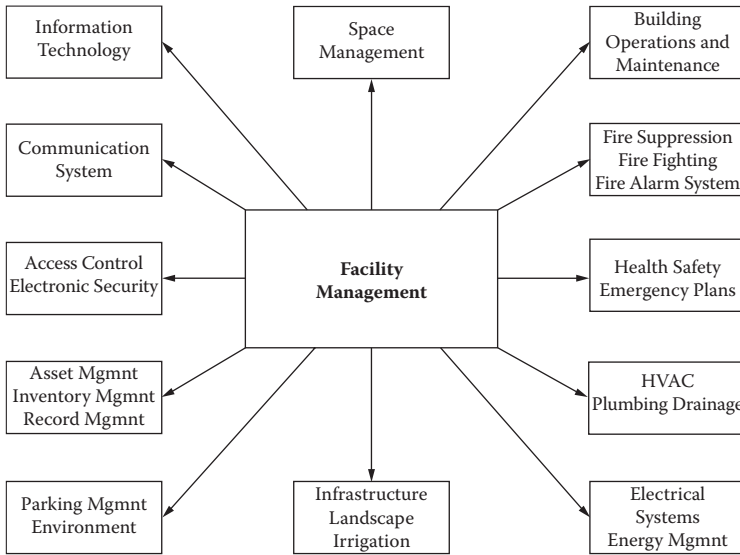

FIGURE 6.1
Areas covered under facility management.

is that the team members must be proactive and embark on a realistic, long-range facility management program. Timely and well-planned maintenance and repair will result in cost savings. The distinction between maintenance management and facilities management is illustrated in the conceptual graph of building capability versus time shown in Figure 6.2.

The facility management function is performed by either an in-house facility management team or an outsourced team.

In both cases, the team members must have innovative approach in day-to-day operations to reduce operating costs and adding value to the business. It is essential that facility management practitioners (in-house or outsourced team) are proactive while carrying out an innovative project, even in the day-to-day operations, and are aware of the trends and developments in the facility management and related industries. Following are the pros and cons of in-house facilities management.

Pros	Cons
<ul style="list-style-type: none"> • More responsive to corporate culture and needs of organization • Sense of “belonging” /being part of client culture • Easier communication and change management decision and processes • Confidentiality issues/ more secure 	<ul style="list-style-type: none"> • Lack of flexibility and availability of multi-disciplinary skills • Too often in-house staff “transferred” from other departments without right skills or training • Lack of exposure to best practice facility management processes and systems • Specialist “in-house” skills not available

TABLE 6.1

FM Market General Characteristics—Europe Versus the Middle East

Europe	Middle East
<ul style="list-style-type: none"> • Matured and structured FM industry • Benchmark and historical data available • Standard RFPs and structured Service Level Agreements are the norm • Clients and service providers conversant with requirements including Performance Measurement Criteria • Best-practice Quality Management System (QMS) and processes “imbedded” in service delivery models • Resources (internal and external) available and trained in FM systems and procedures • Experienced in use of systems technology as key management tools • Experienced FM service providers available who can manage “bundled” services on single solution basis 	<ul style="list-style-type: none"> • Immature and unstructured FM industry • No historical benchmarking data available • Not generally available. Market characterized by poor quality trends and contract documentation • Clients/Suppliers using “construction type” forms of contracts • QMS not generally utilized or implemented • Resources and skills available but not integrated into FM companies • Lack of systems technology and understanding of application and benefits • Lots of small players and single service providers • Some good FM companies exist, but limited number with international and local experience

Source: EMCOR Facilities Services Kuwait. Reprinted with permission from EMCOR Facilities Services Kuwait, www.emcorgroup.com.

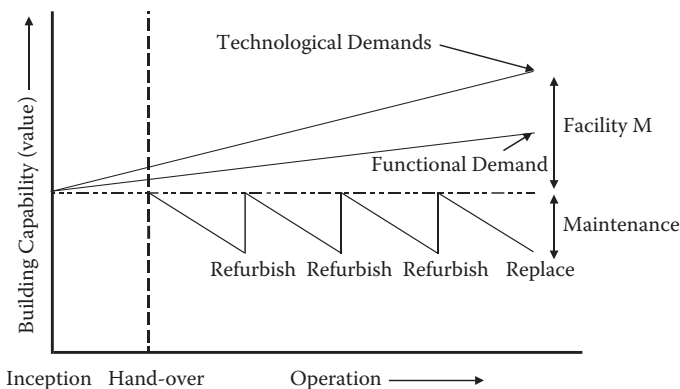

FIGURE 6.2

Conceptual graph of building capability versus time. (From K. Alexander, *Facilities Management: Theory and Practice*, 1996. Reprinted with permission from Cengage Learning Services Ltd.)

TABLE 6.2

Typical Requirements of Facility Management Professional

Serial No.	Requirements
1	Intuitive and managerial skills
2	Ability to improve business performance
3	Ability to satisfy customers
4	Capability of seeking new methods of doing work in order to bring about marked and sustainable improvements in performance of business
5	Ability to develop new or improved facilities, services, technologies that add to the value
6	Ability to perform; choices are backed with a high level of technical understanding
7	Ability to accept full accountability for all actions performed
8	Should be flexible, having visionary skills
9	Willing to accept changes in business and social practices
10	Leadership skills
11	Communication skills
12	Technical and analytical skills
13	Knowledge of industry standards and practices, as well as regulatory mandate
14	Purchasing and contracting skills
15	Personal and interpersonal relationship skills

Facility managers are the professionals most responsible for integrating people with their physical environment. They come from variety of professions. Facility management professionals are judged by their managerial capabilities rather than their technical competence. Facilities professionals need to be trained and equipped with tremendous amount of knowledge and management ability to cope with and solve a multitude of complex problems and challenges. Table 6.2 illustrates typical requirements of a facility management professional.

6.2 Facility Management Outsourcing

Facility management must achieve an organization's objectives and promote an organization's growth. The facility management companies must be able to pool resources to achieve the objectives. While selecting a facility management firm, it is necessary to study the competency of the firm in the following areas:

- Operation and maintenance
- Planning and project management
- Technology

- Quality assessment and innovation
- Management and leadership
- Communication
- Environmental factors

Due to globalization and the competitive market, business outsourcing has become a common factor. The following are the benefits from outsourcing facility management:

- Reduce/control costs
- Access to leading edge technologies
- Focus on core business
- Free resources for other purposes
- Availability of resources not available internally
- Improved, proactive service
- Meet and exceed organization strategic plans

Before deciding to outsource, organizations must decide the following:

- What are core competencies?
- What are current costs and quality of services provided in-house?
- Would it be better to reengineer processes internally to achieve goals?
- What services may be better delivered by an FM service provider?
- What are the goals to be achieved by outsourcing?
- Is a service readily available from suppliers who are better structured to efficiently deliver service at the right price?
- How will the contract (Service Level Agreement) be structured?
- What “in-house” capability/management will be retained/provided to manage service relationships?

If the organization decides to outsource FM, it has to

- Appoint a dedicated project “champion” from within client organization to define and manage the process
- Develop a proper Request for Proposal (RFP) and evaluation criteria
- Engage in a structured and detailed process with a “preferred bidder” to develop
 - “Single source” solutions
 - Properly structured Service Level Agreement (SLA)
- Ensure dedicated and ongoing management of FM services and SLA

6.3 Computer-Aided Facility Management (CAFM)

The facilities management profession has come of age. Its practitioners require skill and knowledge to manage the increasingly broad range of services being included in the facilities management areas. One of the key tools of facilities management included in these different services is an integrated CAFM system. In order to achieve better results, many of the organizational functions are integrated with the help of CAFM. There is special software such as Maximo, Concept 500, Datastream7i, Frontline/Shire systems available to manage these functions. Figure 6.3 illustrates elements of CAFM.

CAFM enables the facility manager and his team to track the status of work, assets, and records in order to manage and communicate an organization's day-to-day operations. The system can provide reports to use in allocating the organization's resources, preparing key performance indicators (KPIs) metrics to use in evaluating the effectiveness of current operations, and for making organizational decisions. The system can be used for space planning, procurement and stores management, assets management budget preparation, statistical reporting, resource allocation and management, security management, waste management, and energy management. CAFM provides integrated facility management.

6.4 Benefits of FM

The following are the benefits of facility management:

- Deliver strategic and operational objectives of the organization
- Increase profits of the organization
- Obtain client satisfaction
- Enhance and project an organization's identity and image
- Deliver business continuity and workforce protection in an era of heightened security threats
- Help the integration process associated with change, postmergers, or acquisitions
- Enable new working styles and processes—vital in this technology-driven age
- Deliver effective management of an organization's assets
- Manage energy efficiently
- Bring about a safe and efficient working environment

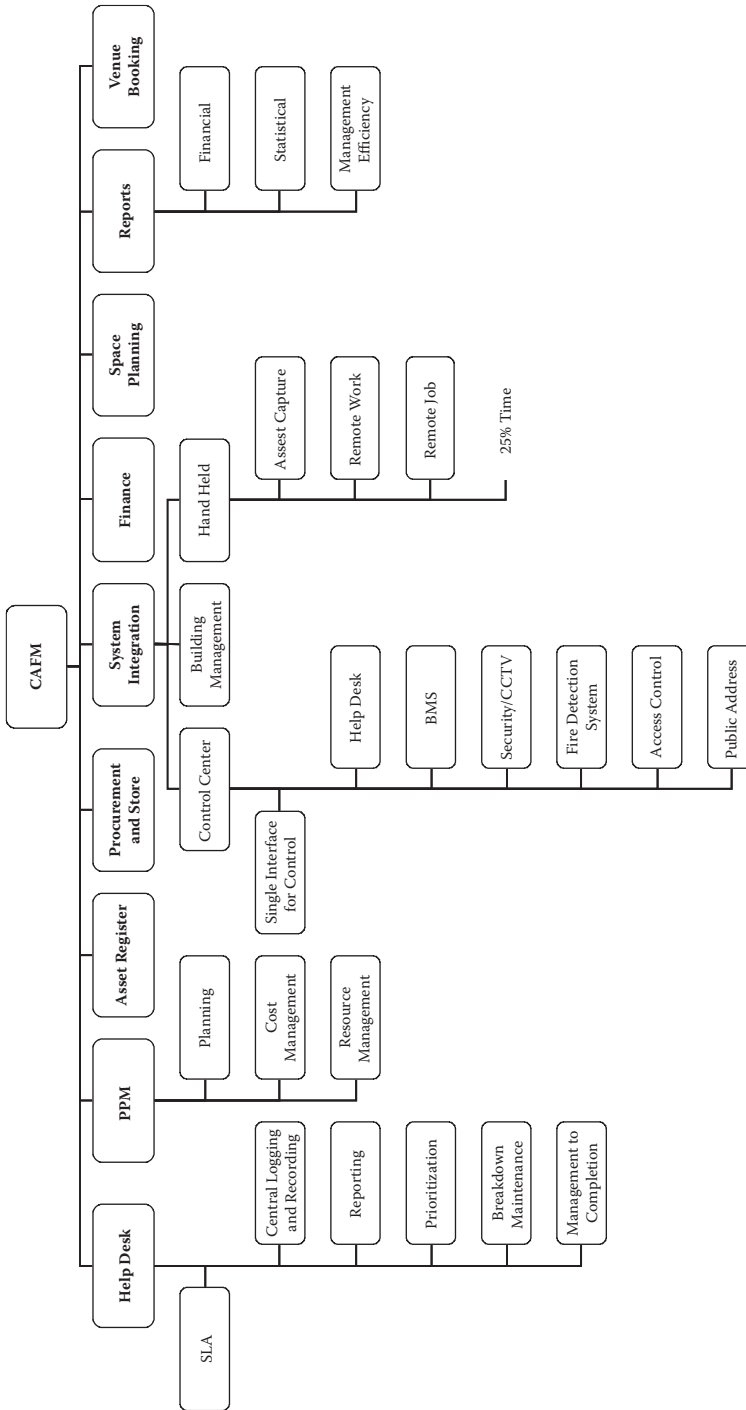

FIGURE 6.3 Elements of computer-aided facility management diagram.

6.5 Quality Requirements of FM

The requirements for facility management are set by the owner of the facility. A facility management organization is required to establish a quality control system to ensure that facilities management work is performed satisfactorily, and there is no interruption or breakdown of the systems. Table 6.3 illustrates an example of quality control requirements for operation and management of the facility. The actual requirements may vary from facility to facility and reflect the importance of various systems and services.

TABLE 6.3

Quality Control Requirements in Facility Management

Serial No.	Work Area	Acceptable Quality Level	Quality Assurance Method
1	Access Control	Not more than one defect per month	100% inspection
2	Asset Management	No defect	100% inspection
3	Building Operations and Maintenance	Not more than 5% defect rate	Random sample
4	Communication System	Not more than 2% defect rate	Random sample
5	Drainage	No defect	100% inspection
6	Electrical System	Not more than 5% defect rate	Random sample
7	Electronic Security	No defect	100% inspection
8	Emergency Plans	Not more than one defect per month	100% inspection
9	Environment	Per regulatory requirements	Per regulatory requirements
10	Fire Alarm System	Not more than 5% defect rate	Random sample
11	Firefighting Plumbing	Not more than 5% defect rate	Random sample
12	Health and Safety	Per regulatory requirements	Per regulatory requirements
13	HVAC	Not more than one defect per month	Random sample Customer complaint
14	Information Technology	No defect	100% inspection
15	Infrastructure	Not more than one defect per month	Random sample
16	Inventory Management	No defect	100% inspection
17	Irrigation	Not more than one defect per month	100% inspection
18	Landscape	No defect	100% inspection
19	Parking Management	Not more than one defect per month	Random sample
20	Plumbing	Not more than one defect per month	100% inspection
21	Record Management	No defect	100% inspection
22	Space Management	Not more than one defect per month	100% inspection

7

Assessment of Quality

7.1 Introduction

In today's global competitive environment, with the increase in customer demand for higher-performing products, organizations are facing many challenges. They are finding that their survival in the competitive market is increasingly in doubt. To achieve a competitive advantage, effective quality improvement is critical for an organization's growth. This can be achieved through development of long-range strategies for quality. Assessment of existing quality systems is helping the development of long-term organizational strategies for quality.

7.2 Assessment Categories

Assessment of quality comprises

1. Cost of poor quality
2. Organization's standing in the marketplace
3. Quality culture in the organization
4. Operation of quality management system

7.2.1 Cost of Poor Quality

This assessment is mainly to find out

1. Customer dissatisfaction resulting due to product failure after sales
2. Annual monetary loss of product and processes that are not achieving their objectives

In order to know customer satisfaction, an independent product survey can be carried out to determine the reasons and improvement measures to be adapted.

Such assessment can be done through a questionnaire related to quality of work (workmanship) and functioning, and getting the customer's opinion/reaction. Table 7.1 lists customer satisfaction questionnaires that can be used to get related information about completed building construction projects.

Management can use the same for quality improvement. Necessary improvement if required for proper functioning of the installed system should be carried out to maintain customer satisfaction. Normally, the contractor is required to maintain the completed project for a certain period under the maintenance contract, and therefore necessary modifications can be carried out during this period. Such defects/modifications have to be recorded by the organization as feedback information and necessary measures can be taken to avoid occurrence of similar things in other projects. The cost involved to carry out such repairs/modifications is borne by the contractor, which helps improve customer satisfaction.

Poor quality results in higher maintenance and warranty charges. In construction projects, these costs are mainly due to

1. Rejection of work during construction: This results in rework by the contractor to meet the specification requirements. If any extra time and cost is required to redo the work, the contractor is not compensated for the same.
2. Rejection of shop drawings: Repeated rejection of shop drawings results in the contractor spending extra time and cost, and a delay in start of relevant activities.

Preventive measures are required for overcoming this problem. Necessary data can be collected to analyze the reasons for rejections. With a cause-and-effect diagram, the reasons for rejection can be analyzed and necessary improvements can be implemented.

7.2.2 Organization's Standing in the Marketplace

A company's standing in the marketplace fetches business opportunities for the organization. The organization needs to know where it stands on quality in the marketplace. This can be done through market study. Numerous questions related to the product should be considered for such studies, which can be carried out by the marketing department of the company. The input from the study should be considered for quality improvement. Various quality tools can be used to analyze the situation and the system can be improved taking into consideration the analysis results.

7.2.3 Quality Cultures in the Organization

The concept of quality culture has changed during the past three decades. The quality approach is centered on organization-wide participation aimed

TABLE 7.1

Customer Satisfaction Questionnaire

Sir/Madam: We are conducting a survey to improve our performance. We would appreciate your response to the following questions. Your valuable information will help us to satisfy your requirements in a better way. (The information provided by you shall be kept confidential.)						
Customer Satisfaction Questionnaire						
Name of Organization:						
Name of Completed Project:						
Q1	Workmanship of the following installed items:					
Serial No.	Work Description	Very Good	Good	Average	Poor	No Comment
1	Structural work					
2	Precast work					
3	Internal finishes					
4	External finishes					
5	Plumbing					
6	Drainage					
7	Firefighting					
8	HVAC					
9	Elevator					
10	Escalator					
11	Electrical work					
12	Landscape work					
13	Pavements					
14	Streets/roads					
15	Water Proofing					
Q2	How are the following systems functioning?					
Serial No.	Systems	Very Good	Good	Average	Poor	No Comment
1	HVAC					
2	Water system					
3	Lighting					
4	Power					
5	Fire alarm system					
	Telephone system					
6	Public address system					
7	Security system					
8	Kitchen equipment					

(Continued)

TABLE 7.1 (Continued)

9	Window cleaning system					
10	Irrigation system					
11	Elevators					
12	Escalators					
Q3	How was the behavior of our site staff?					
Serial No.	Position	Cooperative		Polite	Unpolite	
1	Managers					
2	Engineers					
3	Foreman					
4	Laborers					
5	Office staff					
Q4	How was site safety? Good <input type="checkbox"/> Average <input type="checkbox"/> Poor <input type="checkbox"/>					
Q5	Was project completed per schedule? Yes <input type="checkbox"/> No <input type="checkbox"/>					
Q5A	If your reply to Q5 in No, then please let us know: Have you incurred any revenue loss/any other damages due to non completion in time? Yes <input type="checkbox"/> No <input type="checkbox"/>					
Q6	How was the response to your problems at site? Immediate <input type="checkbox"/> Within one week <input type="checkbox"/> Within two weeks <input type="checkbox"/> No response <input type="checkbox"/>					
Q7	Were our variation claims per contract? Yes <input type="checkbox"/> No <input type="checkbox"/>					
Q8	Are you satisfied with variation settlement method? Satisfied <input type="checkbox"/> Not satisfied <input type="checkbox"/> Need improvement <input type="checkbox"/>					
Q9	Are you satisfied with our performance? Satisfied <input type="checkbox"/> Not satisfied <input type="checkbox"/> Need improvement <input type="checkbox"/>					
Q10	How was the response to your problems from our Head Office? Good <input type="checkbox"/> Poor <input type="checkbox"/> Need improvement <input type="checkbox"/>					
Q11	How do you compare our performance with other competitors? Better than others <input type="checkbox"/> Same as others <input type="checkbox"/> Less than others <input type="checkbox"/>					
Q12	Will you consider inviting us to bid as your new tenders? Yes <input type="checkbox"/> Can't say <input type="checkbox"/>					
Q13	Any suggestion(s)?					

at long-term success through customer satisfaction. It is focused on participative management and strong operational accountability at the individual contribution level.

Employees' opinion and understanding of the company's products and implementation of a quality system help in developing a long-term strategy based on company-wide assessments of quality. This can be achieved through considerate focused group discussion or using questionnaires to survey employees' opinions or by doing both.

Listed below are examples of questions that can be used by building construction organizations asking their employees to respond.

1. Do you know what is good quality for this project?
2. Are you aware of the company's emphasis on quality?
3. Are you familiar with the project quality?
4. Do you know the inspection procedures for this project?
5. Do you know how you can provide high quality workmanship?
6. How you will do the remedial work?
7. How can you improve project quality?

7.2.4 Operation of Quality Management System

This element of assessment is related to the evaluation of present quality management system activities. Assessment of present quality activities can be evaluated from two perspectives:

1. Assessment that focuses on customer satisfaction results but includes an evaluation of the present quality system.
2. Assessment that focuses on evaluation of the present quality system with little emphasis on customer satisfaction results.

In either case, the assessment can be performed by the organization itself or by an external body. The assessment performed by the organization is known as "self-assessment," whereas an assessment performed by an external body is referred as a quality audit. A quality audit is formal or methodical, examining, reviewing, and investigating the existing system to determine whether agreed-upon requirements are being met.

Audits are mainly classified as

First Party—Audits their own organization (Internal Audit)

Second Party—Customer audits the supplier

Third Party—Audits performed by independent audit organization

Third-party audits may result in independent certification of a product, process, or system, such as ISO 9000 quality management system certification. Third-party certification enhances an organization's image in the business circle. The assessment provides feedback to management on the adequacy of implementation and effectiveness of the quality system.

7.3 Self-Assessment

Self-assessment is a comprehensive, systematic, and regular review of an organization's activities, the results of which are referenced against a specific model. The goal of this assessment is to identify

- What your organization is doing well
- What it is not doing well
- What it is not doing at all
- Where and how it can make measurable improvements

As a means of improving the management of organizations companies use models related to quality awards. These are

1. Malcolm Baldrige National Quality Award (USA)
2. European Quality Award (Europe)
3. Deming Prize (Japan)

The Baldrige Award is presented annually by the President of the United States of America to organizations that demonstrate quality and performance excellence in manufacturing, service, small business, education, health care, and nonprofit organizations that apply and are then judged to be outstanding in seven categories. These categories are

- Category No. 1—Leadership
- Category No. 2—Strategic planning
- Category No. 3—Customer and market focus
- Category No. 4—Measurement, analysis, and knowledge management
- Category No. 5—Workforce focus
- Category No. 6—Process management
- Category No. 7—Results

The Baldrige National Quality Program promotes an understanding of requirements for performance excellence and fosters sharing information

about successful performance strategies and the benefits derived from using these strategies. Many organizations use Baldrige criteria to conduct self-assessments without submitting an application for the award and use the result to identify improvement opportunities within the organization for performance excellence.

Appendix A: Design Review Checklists

TABLE A.1

Design Checklist: Architectural Work

Serial No.	Item	Yes	No	Action Required
1	Check property limits			
2	Check building dimensions per approval from authorities			
3	Check that modules match with structural layout			
4	Check for energy conservation measures			
5	Check for constructability			
6	Check user requirements about zoning area			
7	Check no. of rooms and room size per occupancy and purpose			
8	Check relationship between all the services requirements and project user items (rooms, etc.)			
9	Check horizontal and vertical transportation (stairs, elevators, escalators) and escape routes per architectural norms			
10	Check no. of floors and area of each floor			
11	Check level of each floor			
12	Check axis, grid			
13	Check elevations, sections and details			
14	Check system ventilation			
15	Check floor plans			
16	Check roof plan			
17	Check wall openings			
18	Check suitable locations and spaces for equipment			
19	Check finishes of all areas with respect to cost range			
20	Check finishes schedule			
21	Check schedule of doors and windows			
22	Check access for maintenance of equipment/ services requirement			
23	Check for suitability of appropriate roofing system			
24	Check room/area identification is provided			
25	Check fire protection requirements			
26	Check safety requirements			
27	Check requirements for those with special needs			

TABLE A.2

Design Checklist: Structural Work

Table A.2.1 Foundation Layout

Serial No.	Item	Yes	No	Action Required
1	Check that latest architectural drawing is used			
2	Check axis and grids match architectural layout			
3	Check location of columns axis			
4	Check that depth of excavation matches required depth for no. of basements			
5	Check for thickness of blinding concrete			
6	Check that waterproofing and moisture protection material is suitable for subsurface conditions			
7	Check that foundation design is consistent with geotechnical report/soil report			
8	Check footing details for foundation			
9	Check that seismic requirements for foundation are considered			
10	Check footing design			
11	Check minimum concrete cover considered			
12	Check total load calculated and considered			
13	Check coefficient of sliding on foundation soil considered			
14	Check levels are shown			
15	Check expansion joints are shown			
16	Check reinforcement details are shown			
17	Check spacing arrangement for reinforcement			
18	Check foundation for pits, tanks considered			
19	Check for type of concrete and steel			
20	Check for earthquake, seismic control requirements			

Table A.2.2 Basement Design**a) Basement: Retaining Wall**

Serial No.	Item	Yes	No	Action Required
1	Check that latest architectural drawing is used			
2	Check axis and grids match architectural layout			
3	Check property limit/boundary limit			
4	Check column axis matches architectural drawings			
5	Check thickness of retaining wall against all type of forces/loads			
6	Check waterproofing, damp proofing requirements			

Table A.2.2 Basement Design (Continued)

Serial No.	Item	Yes	No	Action Required
7	Check insulation requirements			
8	Check that seismic load is considered			
9	Check required openings for services, sleeves			
10	Check reinforcement for retaining wall			
11	Check for expansion joints			
12	Check for wall footing			
13	Check that levels are shown			
14	Check if fair faced wall is needed			
b) Basement: Columns				
1	Check that latest architectural drawing is used			
2	Check that axis and grids match architectural layout			
3	Check that load factor is considered			
4	Check that column axis matches architectural drawings			
5	Check column orientation matches architectural drawings			
6	Check axial load and bending moment per ACI			
7	Check reinforcement area			
8	Check minimum concrete cover			
9	Check for type of concrete and steel			
10	Check column dimensions			
11	Check for deflection			
12	Check for temperature effect			
13	Check tie size and spacing			
14	Check levels are shown			
c) Basement: Beams				
1	Check that latest architectural drawing is used			
2	Check that axis and grids match architectural layout			
3	Check floor framing plan			
4	Check location of columns, walls, stairs			
5	Check minimum depth/height of beam			
6	Check applied moment			
7	Check steel ratio			
8	Check design for longitudinal bars			
9	Check deflection			
10	Check stirrup design			
11	Check dimensions of beam			
12	Check levels are shown			

(Continued)

Table A.2.2 Basement Design (Continued)

Serial No.	Item	Yes	No	Action Required
d) Basement: Slab				
1	Check that latest architectural drawing is used			
2	Check that axis and grids match architectural layout			
3	Check total load and load factor			
4	Check span length matches architectural requirements			
5	Check type of slab per design requirements			
6	Check that moment and other forces are considered			
7	Check steel area			
8	Check minimum concrete cover area			
9	Check openings are considered for services requirement			
10	Check for deflection			
11	Check if slope is required			
12	Check provision for floor drains for drainage, sanitary system			
13	Check that levels are shown			
14	Check that expansion joints are shown			
15	Check authorities requirements for fire protection			
e) Basement: Stairs				
1	Check that latest architectural drawing is used			
2	Check that axis and grids match architectural layout			
3	Check that location of stairs matches architectural layout, and is per authorities requirements			
4	Check that width of stairs matches architectural requirements			
5	Check riser height			
6	Check landing platform is provided per code			
7	Check reinforcement details for stairs			
8	Check if balustrade is required per architectural requirements			

Table A.2.3 Super Structure

a) Super Structure (Ground Floor, Typical Floors)

Serial No.	Item	Yes	No	Action Required
1	Check per appropriate tables for relevant items			

Table A.2.4 Roof Slab

Serial No.	Item	Yes	No	Action Required
1	Check per Tables 4.3.1.3 B. d)) for relevant items			
2	Check for skylight, if any			
3	Check for parapet wall			
4	Check that equipment loads considered			
5	Check for openings for services			
6	Check openings for hatches, lightwells, stairwells			
6	Check foundation for equipment			
7	Check for levels			
8	Check if any slope is required			

Table A.2.5 General Requirements

Serial No.	Item	Yes	No	Action Required
1	Check elevator shaft dimensions			
2	Check elevator shaft reinforcement			
3	Check opening for elevator door and its level			
4	Check openings in the slab for elevator works			
5	Check pit and supports for escalator (if required)			

TABLE A.3

Design Checklist: HVAC Work

Table A.3.1 HVAC Duct Layout

Serial No.	Item	Yes	No	Action Required
1	Check that latest architectural drawing is used			
2	Check if legends match layout			
3	Check if ducting route properly shown			
4	Check if levels are shown			
5	Check if air inlet/outlets coordinate with false ceiling plan and architectural requirements			
6	Check if air inlet/outlets locations coordinate with other services			
7	Check if required shafts are shown			
8	Check if duct layout coordinates with other trades			
9	Check if duct layout coordinates with false ceiling plans			
10	Check if all the duct accessories are shown			
11	Check if air inlet/outlets connect to the duct			
12	Check if duct connects to the related equipment			

Table A.3.2 HVAC Piping Layout

Serial No.	Item	Yes	No	Action Required
1	Check that latest architectural drawing is used			
2	Check if legends matches layout			
3	Check if piping route properly shown			
4	Check if levels are shown			
5	Check if valve and other piping accessories shown			
6	Check if required shafts are shown			
7	Check if piping layout coordinates with other trades			
8	Check if piping layout coordinates with false ceiling plans			

Table A.3.3 HVAC Equipment Selection

a) Check selection of following (applicable) equipment

Serial No	Item	Yes	No	Action Required
1	Chiller			
2	Cooling tower			
3	Chilled water/condensing water pumps			
4	Air handling units (AHU)/Heat recovery unit (HRU)			
5	Fan coil units (FCU)			
6	DX mini split units			
7	Fans			
8	Heat exchanger			
9	Duct accessories a) VAV b) Sound attenuator			
10	Pipe accessories			
b) Check equipment schedule for (applicable) equipment per requirements under a)				

Table A.3.4 HVAC Control Schematic

Serial No.	Item	Yes	No	Action Required
1	Check control schematic of chiller with pumps			
2	Check control schematic of cooling tower with pumps			
3	Check control schematic for chemical treatment for chilled water/condensing water pumps			
4	Check control schematic of air handling units (AHU)/heat recovery unit (HRU) with related accessories			
5	Check control schematic for VAV with accessories			
6	Check control schematic of smoke exhaust/fresh air fans system			
7	Check control schematic of heat exchanger			
8	Check control schematic of duct heater with accessories			
9	Check control schematic of BMS with accessories			

Table A.3.5 HVAC Building Management System

Serial No.	Item	Yes	No	Action Required
1	Check if all the devices/sensors/detectors are connected in the loop			
2	Check that devices/sensors/detectors are shown			
3	Check location of DDC panels shown			
4	Check for interface with other services			
	Check that following equipment/systems are included in the BMS point schedule			
	a) HVAC equipments			
	b) Sump pumps			
	c) Diesel generator			
	d) Main low tension panels			
	e) Distribution boards, if required			
	f) Other			

Table A.3.6 HVAC Sections and Plants

Serial No.	Item	Yes	No	Action Required
1	Check that all related sections and details for equipment, duct and piping are shown			

Table A.3.7 HVAC-Related Electrical Works

Serial No.	Item	Yes	No	Action Required
1	Check HVAC-related electrical works and applicable interface with other systems (BMS)			

TABLE A.4

Design Checklist: Plumbing and Fire Protection System

Table A.4.1 Plumbing System

a) Water Supply Layout

Serial No.	Item	Yes	No	Action Required
1	Check that latest architectural drawing is used			
2	Check if legends match layout			
3	Check that water supply is meeting the usage requirements			
4	Check if cold water supply route properly shown			
5	Check if levels are shown			
6	Check if pipe sizes are suitable for proper flow of water			
7	Check that hot water supply route is properly shown			
8	Check if water storage capacity is adequate to meet required demand			
9	Check if required shafts are shown			
10	Check if piping layout coordinate with other trades			
11	Check if piping connects to the related equipment			
12	Check for water pressure requirements			
13	Check that all the fittings and accessories are considered			
b) Selection of Pumps and Plant Layout				
1	Check that latest architectural drawing is used			
2	Check if legends match layout			
3	Check that all plant room equipment is included			
4	Check calculation for selection of pumps			
5	Check that pipe connections are shown			
6	Check that piping accessories are included and shown			
7	Check that necessary foundations for equipment are shown			
8	Check that power supply for pumps is available			
9	Check that interface of equipment with BMS is provided			

Table A.4.2 Drainage System**a) Sanitary Drainage Layouts**

Serial No.	Item	Yes	No	Action Required
1	Check that latest architectural drawing is used			
2	Check if legends match layout			
3	Check calculations for foul drainage demand and frequency factor for following items: a) Wash basins b) Showers c) Urinals d) Restrooms e) Kitchen sinks Other equipment such as dishwashers, washing machines			
4	Check that inspection manhole/chamber is provided in the vicinity of the facility			
5	Check if vent for toilet is provided			
6	Check if pipe size and slope are adequate to ensure self-cleaning			
7	Check if floor drain is provided in every toilet and kitchen			
8	Check if oil/grease interceptors are provided (if applicable)			
9	Check sump pump size calculations			
10	Check sump pit dimension calculations			
11	Check for relevant public authority approval for connection of drainage system to area network			
b) Storm Drainage Layout				
1	Check that latest architectural drawing is used			
2	Check if legends match layout			
3	Check if rainfall intensity matches recommendation of the authority			
4	Check that no. of roof drains are enough to meet the stormwater flow			
5	Check if stormwater pipe size meets requirements			
6	Check size of gullys and gutters			
7	Check necessary foundations for equipment shown			
8	Check for no. of manholes			
9	Check if connections to area network are shown			

Table A.4.3 Fire Protection System

a) Sprinkler Layout

Serial No.	Item	Yes	No	Action Required
1	Check that latest architectural drawing is used			
2	Check if legends match layout			
3	Check if sprinkler route is properly shown			
4	Check if levels are shown			
5	Check if sprinkler system matches authorities requirements			
6	Check if sprinkler location coordinates with false ceiling plan and architectural requirements			
7	Check if sprinkler locations coordinate with other trades			
7	Check if required shafts are shown			
8	Check if piping layout coordinates with other trades			
9	Check if piping connects to the related equipment			
b) Pump Selection				
1	Check if fire pump size is per NFPA/KFD requirements			
2	Check that normal and standby pumps are selected and shown			
3	Check that jockey pump is selected and shown			
4	Check if pumps are shown in the pump room			
5	Check if pumps are connected to piping system			
6	Check if pumps are provided with power and are coordinated with electrical trade for power supply requirement (both normal and emergency)			
7	Check that starter/control panel is provided			
8	Check that interface requirements are shown			
9	Check technical data sheet for selected fire pump			
10	Check that valves and other accessories are shown			
11	Check that pump detail plans are shown			

Table A.4.4 Special Systems

Serial No.	Item	Yes	No	Action Required
1	Check for FM 200 system			
2	Check for foam system			
3	Check fire hydrant layout			
4	Check hose reel layout			

TABLE A.5

Design Checklist: Electrical System

a) Lighting Layout

Serial No.	Item	Yes	No	Action Required
1	Check that latest architectural drawing is used			
2	Check if legends match layout			
3	Check if summary of Luminaire includes all the fixtures shown on the drawing			
4	Check if all areas are provided with lighting			
5	Verify if illumination calculation/isolux diagram requirements match fixtures shown on the lighting layout			
6	Check if specified fittings match reflected ceiling plan/architectural requirements			
7	Check if circuiting references for all fixtures (both normal and emergency) are shown			
8	Check if switch arrangements and location of switches are shown			
9	Check if push buttons, dimmer, and LCP (if any) are located.			
10	Check if exit lights are shown			
11	Check if emergency lights are shown			
12	Check if lights are provided in elevator shaft			
13	Check if wire sizes for circuits are correct			
14	Verify voltage drop for circuit wiring			
15	Check if consistency is maintained to indicate type of light fixtures for all circuits			
16	Check if all DBs are located and demarcated			
17	Check where all dimmer panels, if any, are located			
18	Check where lighting control panel, if any, is located			
19	Check if the circuiting references match DB schedules			
20	Check that no. of fittings in a circuit do not exceed MEW specified limit			
21	Check DB schedule for contactor, switches, pushbutton and interface with BMS (if any)			
22	Check for DB schedule load balancing			
b) Power				
1	Check that latest architectural drawing is used			
2	Check if legends match layout			
3	Check if outlets are provided in rooms/general areas and locations are coordinated			
4	Check if outlets are provided in kitchen			

TABLE A.5 (CONTINUED)

Design Checklist: Electrical System

Serial No.	Item	Yes	No	Action Required
5	Check if outlets/isolators are provided in kitchen for equipment/appliances per kitchen equipment layout			
6	Check if ring circuiting is per codes, regulations			
7	Check for location of socket outlets/isolators for PH equipment and if ratings are suitable for connected load			
8	Check for location of socket outlets/isolators for firefighting equipment and if ratings are suitable for connected load			
9	Check for location of socket outlets/isolators for HVAC equipment and if ratings are suitable for connected load			
10	Check for location of socket outlets/isolators for low voltage equipment and if ratings are suitable for connected load			
11	Check for location of isolators for conveying system equipment and if ratings are suitable for connected load			
12	Check if circuit references are correct per DB schedule			
13	Check if wire/cable sizes are correct per voltage drop calculation			
14	Check if socket outlet is provided in elevator pit			
15	Check if all EDB/DBs are located and demarcated			
16	Verify voltage drop for circuit wiring			
17	Check if circuit references are correct per SMSB schedule/schematics			
18	Check if all ESMSB/SMSBs are located and demarcated			
19	Check if all EMSB/MSBs are located and demarcated			
20	Check if breaker sizes of EDB/DBs are correct			
21	Check if breaker sizes of ESMSB/SMSB are correct			
22	Check if breaker sizes of EMSB/MSB are correct			
23	Check if emergency power is proved for all equipment to be operated under fire mode/emergency			
24	Check if emergency power is provided for all security equipment			

(Continued)

TABLE A.5 (CONTINUED)

Design Checklist: Electrical System

Serial No.	Item	Yes	No	Action Required
25	Check if cable tray sizes are per codes, regulations			
26	Check if cable tray routes are shown			
27	Check if risers are shown			
28	Check if switchboard schematic matches load schedule			
29	Check if the breakers ratings shown on schematic are suitable for connected load			
30	Check if bus bar rating of schematic is 1.25 times incoming breaker size			
31	Check if ELR is shown for spare breaker			
32	Check if AV alarm is shown for fire alarm panel circuit			
33	Check if AV alarm is shown for sanitary and stormwater pump circuit			
34	Check if AV alarm is shown for smoke fan and fresh air supply fan circuits			
35	Verify voltage drop calculation for outgoing feeders			
36	Check if equipment/isolators are identified for all outgoing circuits of schematics			
37	Check if earthing is shown in the schematics for all equipment and isolators			
38	Check schematic for MCC Panel, type of starter, size and no. of wires, cable size, and verify if the breaker sizes are suitable for connected load			
39	Check if the size of downstream breakers of LT panel schematic is suitable for connected load			
40	Check for shunt trip, if any			
41	Check LT panel schematic with load schedule			
42	Check if ACB size, bus coupler (if any), bus bar rating of LT panel schematic is per codes, regulations			
43	Check if all metering is shown on the LT schematic			
44	Check if ATS (if any) is shown and connected to the LT panel/MSB			
45	Check D.G. set (if required) and its panel is located			
46	Check no. of transformer and ratings			
47	Check substation layout			
48	Check earthing/grounding system			
49	Check lightning protection system			

TABLE A.6

Design Checklist: Landscape

Serial No.	Item	Yes	No	Action Required
1	Check property limits			
2	Check landscape settings and levels			
3	Check water percolation in landscape area			
3	Check grass area and edges			
4	Check location/demarcations of plants, shrubs, trees			
5	Check irrigation system, water distribution to plants, water reservoirs and pumping system			
6	Check location of special features			
7	Check location of sidewalk, pedestrian paths			
8	Check pavement, curbstone details			
9	Check lighting bollard, light poles and signage			
10	Check utility services both under and above ground			
11	Check material storage and workshop facility for landscape maintenance			

TABLE A.7

Design Checklist: Infrastructure

Serial No.	Item	Yes	No	Action Required
1	Check grading details			
2	Check asphalt/paving area			
3	Check asphalt/paving details			
4	Check pavement, curbstone area and details			
5	Check location of light poles			
6	Check utility services routes			
7	Check trenches and tunnels for services			
8	Check location of manholes and handholes			
9	Check traffic signs and markings			
10	Check security system requirements			

Appendix B: Major Activities in Building Construction Projects

Serial No.	Description
<i>Shoring</i>	
1	Shoring
2	Dewatering
<i>Earthworks</i>	
1	Excavation
2	Backfilling
<i>Concrete Substructure</i>	
1	Blinding Concrete
2	Termite Control
3	Reinforcement for Raft
4	Casting of Raft Foundation
5	Reinforcement for Grade Beams
6	Shuttering for Grade Beams
7	Concrete Casting of Grade Beams
8	Reinforcement for Footings
9	Shuttering for Footings
10	Concrete Casting of Footings
11	Reinforcement for Wall and Columns
12	Shuttering for Wall and Columns
13	Concrete Casting of Retaining Wall
<i>Concrete Super Structure</i>	
1	Reinforcement for Columns
2	Shuttering for Columns
3	Concrete Casting of Columns
4	Formwork for Slab
5	Reinforcement for Slab
6	Shuttering for Beams
7	Reinforcement for Beams
8	Concrete Casting of Slab
9	Shuttering for Stairs
10	Reinforcement for Stairs
11	Concrete Casting of Stairs
12	Shuttering for Wall and Columns
13	Reinforcement for Wall and Columns
14	Concrete Casting of Wall and Columns
15	Precast Panels

Serial No.	Description
<i>Masonry</i>	
1	Block work
2	Concrete Unit Masonry
<i>Partitioning</i>	
1	Installation of Frames
2	Installation of Panels
<i>Metal Work</i>	
1	Structural Steel Work
2	Installation of Cat Ladders
3	Installation of Balustrade
4	Installation of Space Frame
5	Installation of Handrails and Railings
<i>Thermal and Moisture Protection</i>	
1	Applying Waterproofing Membrane
2	Installation of Insulation
<i>Doors and Windows</i>	
1	Aluminum Windows
2	Aluminum Doors
3	Glazing
4	Steel Doors
5	Steel Windows
6	Wooden Frames
7	Wooden Doors
8	Curtain Wall
9	Hatch Doors
10	Revolving Door
11	Louvers
<i>Internal Finishes</i>	
1	Plastering
2	Painting
3	Cladding—Ceramic
4	Cladding—Gypsum
5	Cladding—Marble
6	Ceramic Tiling
7	Stone Flooring
8	Acoustic Ceiling
9	Gypsum Board Ceiling
10	Glass Reinforce Gypsum Ceiling
11	Metal Tile Ceiling
12	Demountable Partitions

Serial No.	Description
<i>Furnishing</i>	
1	Carpeting
2	Blinds
3	Furniture
<i>External Finishes</i>	
1	Painting
2	Brickwork
3	Stone
4	Cladding—Aluminum
5	Cladding—Granite
6	Curtain Wall
7	Glazing
<i>Equipment</i>	
1	Installation of Maintenance Equipment
2	Testing of Maintenance Equipment
3	Installation of Kitchen Equipment
4	Testing of Kitchen Equipment
5	Installation of Parking Control
6	Testing of Parking Control System
<i>Roof</i>	
1	Parapet Wall
2	Thermal Insulation
3	Waterproofing
4	Roof Tiles
5	Installation of Drains
6	Installation of Gutters
<i>Elevator System</i>	
1	Installation of Raceways
2	Installation of Rails
3	Installation of Door Frames
4	Installation of Cabin
5	Cabin Finishes
6	Installation of Wire Rope
7	Installation of Drive Machine
8	Installation of Controller
9	Testing of Elevator
10	Third-Party Inspection
<i>HVAC Works</i>	
1	Installation of Piping A. Chilled Water

Serial No.	Description
	B. Condensing Water
	C. Hydrostatic Test
2	Installation of Ducting A. Air Conditioning Duct B. Exhaust Duct
3	Installation of Insulation A. Pipe B. Duct
4	Installation of Dampers
5	Installation of Grills and Diffusers
6	Installation of Cladding
7	Installation of Fans A. Exhaust B. Fresh Air C. Ventilation D. Pressurization
8	Installation of Fan Coil Units (FCU)
9	Installation of Air Handling Units (AHU)
10	Installation of Pumps
11	Installation of Chillers
12	Installation of Cooling Towers
13	Installation of Thermostat and Controls
14	Installation of Starters
15	Electrical Works/Termination of Pumps
16	Electrical Works/Termination of AHU, FCU
17	Electrical Connection/Termination of Chillers, Cooling Towers
18	HVAC Water Treatment
19	Start-up of Pump
20	Flushing of Piping System
21	Start-up of Chillers
22	Start-up of Cooling Towers
23	Start-up of AHUS
24	Start-up of Fan Coil Unit
25	Building Management System (BMS) A. Conduiting B. Wiring-Cabling C. Components D. Termination
26	Testing of HVAC System
27	Testing of BMS
28	Testing Adjusting and Balancing

Serial No.	Description
<i>Mechanical Works</i>	
A. Water Supply	
1	Installing of Piping
2	Installation of Valves
3	Installation of Pumps
4	Electrical Works/Termination of Pumps
5	Filter Units
6	Toilet Accessories
	A. Wash Basin
	B. Toilet
	C. Urinals
	D. Valves
	E. Mixers
	F. Kitchen Sinks
7	Installation of Insulation
8	Water Heaters
9	Hand Dryers
10	Water Tank
11	Electrical Works/Termination of Pumps, Heaters
12	Controls—Level Indicator
13	Flushing of System
14	Testing of Water Supply System
B. Drainage System	
1	Installation of Pipes below Grade
2	Installation of Pipes above Grade
3	Installation of Manholes
4	Installation of Clean-Out
5	Installation of Floor Drain
6	Installation of Sump Pumps
7	Electrical Works/Termination of Pumps
8	Installation of Gratings
9	Testing of Sump Pumps
C. Irrigation System	
1	Installation of Pipes
2	Installation of Valves
3	Installation of Pumps
4	Installation of Controls
5	Installation/Connection with Weather Station
6	Installation of Central Control System
7	Testing of Irrigation System

Serial No.	Description
D. Fire Fighting System	
1	Installation of Piping
2	Installation of Valves
3	Installation of Flow Switches
4	Installation of Sprinklers
5	Installation of Foam System
6	Installation of Pumps
7	Installation of Hose Reels/Cabinet
9	Electrical Works/Termination of Pumps
10	Installation of Fire Hydrant
11	External Fire Hose Cabinet
12	Testing of Fire Fighting System
<i>Electrical Works</i>	
1	Conduiting—Raceways
2	Cable Tray—Trunking
3	Floor Boxes
4	Wire Pulling
5	Cable Pulling
6	Installation of Bus Duct
7	Meggering of Wires and Cables
8	Installation of Wiring Devices/Accessories
9	Installation of Light Fittings
10	Installation of Earthing Tape
11	Earth Pits
12	Distribution Boards (DBs) Installation
13	DBs Termination
14	Installation of Lighting Control Panel
15	Testing of Lighting Control Panel
16	Installation of Isolators
17	Installation of Sub Main Switch Boards (SMSBs)
18	Installation of MSBs
19	Installation of Motor Control Center (MCC) Panels
20	Termination of SMSBs
21	Termination of Main Switch Boards (MSBs)
22	Testing of MCC Panels
23	Installation of Automatic Transfer Switch (ATS)
24	Termination of ATS
25	Testing of DBs
26	Testing of SMSBs
27	Testing of MSB
28	Installation of Main Low Tension Boards (MLTBs)
29	Installation of Generator
30	Testing of Generator

Serial No.	Description
31	Testing of ATS
32	Testing of MLTBs
33	Installation of Central Battery System
34	Testing of Central Battery System
<i>Fire Alarm System</i>	
1	Conduiting, Raceways
2	Installation of Cable Trunking
3	Wiring, Cabling
4	Installation of Detectors, Bells, Pull Stations, Interface Modules
5	Installation of Repeater Panel
6	Installation of Mimic Panel
7	Installation of Fire Alarm Panel
8	Interface with other equipment
9	Testing of Fire Alarm System
<i>Telephone/Communication System</i>	
1	Conduiting, Raceways
2	Installation of Cable Trunking, Cable Tray
3	Wiring, Cabling
4	Termination of Cables
5	Installation of Wiring Devices
6	Installation of Racks
7	Termination of Cable at the Racks
8	Testing of Structured Cabling
9	Installation of Switches
10	Installation Telephone Sets
11	Testing of System
<i>Public Address System</i>	
1	Conduiting, Raceways
2	Cable Tray, Trunking
3	Wiring, Cabling
4	Installation of Speakers
5	Installation of Racks
6	Installation of Equipment
7	Testing of Public Address System
<i>Audio Visual System</i>	
1	Conduiting, Raceways
2	Cable Tray, Trunking
3	Wiring, Cabling
4	Installation of Speakers
5	Installation of Monitors/Screens
6	Installation of Racks

Serial No.	Description
7	Installation of Equipment
8	Testing of Audio Visual System
	<i>CCTV/Security System</i>
1	Conduiting, Raceways
2	Wiring, Cabling
3	Installation of Cameras
4	Termination of Cameras
5	Installation of Panels
6	Termination of Panels
7	Installation Monitors/Screens
8	Testing of Security System
	<i>Access Control</i>
1	Conduiting, Raceways
2	Wiring, Cabling
3	Installation of RFID Proximity Readers, Fingerprint Readers
4	Installation of Magnetic Locks, Release Buttons, Door Contacts
5	Installation of Panel
6	Installation of Server
7	Testing of System
	<i>Systems Integration</i>
1	Installation of Switches
2	Installation of Servers
3	Systems Integration Programming
	<i>Landscape</i>
1	Site Clearance
2	Excavation
3	Soil Preparation
4	Plantation
5	Pavement and Sidewalk
6	Special Features (if any)
7	Irrigation System
8	Lighting Poles/Bollards
	<i>External Works (Infrastructure)</i>
1	Site Clearance
2	Cutting and Filling Work
3	Grading
4	Asphalt Work
5	Light Poles
6	Water Supply Piping Work

Serial No.	Description
7	Fire Fighting Work
8	Storm Water Piping Work
9	Drainage Work
10	Curbs and Pavement Work
11	Hard Landscape Work
12	Road Marking Work
13	Traffic Signs and Signals

Appendix C: Content of Contractor's Quality Control Plan

- 1.0 Introduction
- 2.0 Description of project
- 3.0 Quality control (QC) organization
- 4.0 Qualification of QC staff
- 5.0 Responsibilities of QC personnel
- 6.0 Procedure for submittals
 - 6.1 Submittals of subcontractor(s)
 - 6.2 Submittals of shop drawings
 - 6.3 Submittals of materials
 - 6.4 Modification request
 - 6.5 Construction program
- 7.0 Quality control procedure
 - 7.1 Procurement
 - 7.2 Inspection of site activities (checklists)
 - 7.3 Inspection and testing procedure for systems
 - 7.4 Off-site manufacturing, inspection, and testing
 - 7.5 Procedure for laboratory testing of material
 - 7.6 Inspection of material received at site
 - 7.7 Protection of works
 - 7.8 Material storage and handling
- 8.0 Method statement for various installation activities
- 9.0 Project-specific procedures
- 10.0 Quality control records
- 11.0 Company's quality manual and procedures
- 12.0 Periodical testing
- 13.0 Quality updating program
- 14.0 Quality auditing program
- 15.0 Testing, commissioning, and handover
- 16.0 Health, safety, and the environment (HSE)

Contractor's Quality Control Plan

The Contractor's Quality Control Plan is prepared based on project-specific requirements as specified in the contract documents.

The plan outlines the procedures to be followed during the construction period to attain the specified quality objectives of the project fully complying with the contractual and regulatory requirements.

Following is an outline of such a plan, based on contract documents.

1.0 Introduction

The Contractor's Quality Control Plan is developed to meet Contractor's Quality Control (CQP) requirements of (Project Name) as specified under clause (---) and section (---) of contract documents.

The plan provides the mechanism to achieve the specified quality by identifying the procedures, control, instructions, and tests required during the construction process to meet the owner's objectives. This QCP does not endeavor to repeat or summarize contract requirements. It describes the process M/S ABC (Contractor Name) will use to assure compliance with those requirements.

2.0 Description of Project

(Owner Name) has contracted M/S ABC to construct (name of facility) located at (site plan). The facility consists of approximately (---) m² gross building area and approx (---) m² of two basements for car parking and other services.

The facility is to be used as office premises to accommodate (---) personnel. The architecture of the building is of very high quality with a spacious atrium between two towers interconnected with a bridge inside the building, and a well-designed internal landscape area with plants and sky garden to provide a pleasant view inside the building. The building has glazed walls and curtain walling for the atrium area.

Vertical transportation is through panoramic elevators and a designated elevator for VIPs. Additionally, there is a goods elevator and firefighters' elevator to meet an emergency situation.

The structure of the building is of reinforced concrete, and the atrium is of structured steel. External cladding includes a spandrel curtain wall for the block structure and special curtain walling for the atrium. Interior finishes are painted plastered walls and marble and stone finish. Internal partitions have flexibility to adjust the office area. The entire building has a raised floor system, and space under the raised floor is used for distribution of electro-mechanical services.

The HVAC system is comprised of water-cooled chillers, and electric ducts heaters are provided for heating during winter. BMS takes full control of

HVAC. Building is provided with all the safety measures against fire. A fire protection system, smoke exhaust fans, and fire alarm system with voice evacuation system are provided to meet an emergency situation. The fire protection system also includes automatic sprinklers, hose reels, extinguishers, and a foam system.

The building is equipped with all the amenities required for a public health system. The plumbing system is consistent with the requirement of the building and includes cold and hot water, drainage, rain water collection, and an irrigation system. Water fountains are provided at various locations for drinking purposes.

Electrical systems consist of energy-saving lighting with centralized controls. Electrical distribution has all required safety features. A diesel generator system and uninterrupted power supply system is provided to meet the emergency due to power failure from the main electricity provider. The building to be constructed should be equipped with the latest technological systems. It should have an IP-based communication system, and all the low-voltage systems should be fully integrated. Authorized persons should have access from anywhere, either from within the building or outside.

The building has fully integrated low-voltage systems.

Apart from training and conference facilities, a fully functional auditorium having capacity for (---) people and conferencing is available in the building. It has a sophisticated conferencing system with a rear projection screen.

The contract documents consist of total (---) contract drawings. These are

Architectural	(---) nos.
Architectural Interior	(---) nos.
Structural	(---) nos.
Electrical	(---) nos.
Mechanical (HVAC)	(---) nos.
Public Health	(---) nos.
Firefighting	(---) nos.
Smart Building	(---) nos.
Traffic Signage	(---) nos.
Landscape	(---) nos.

3.0 Quality Control Organization

The QC organization is independent of those persons actually performing the work. They should be responsible for implementing the quality plan for the entire contract/project-related activities by scheduling the inspection, testing, sampling, and preparation of mockup and to assure that works are performed per approved shop drawings and contract documents.

An organization chart showing the line of authority and functional relationship is shown in Figure C.1.

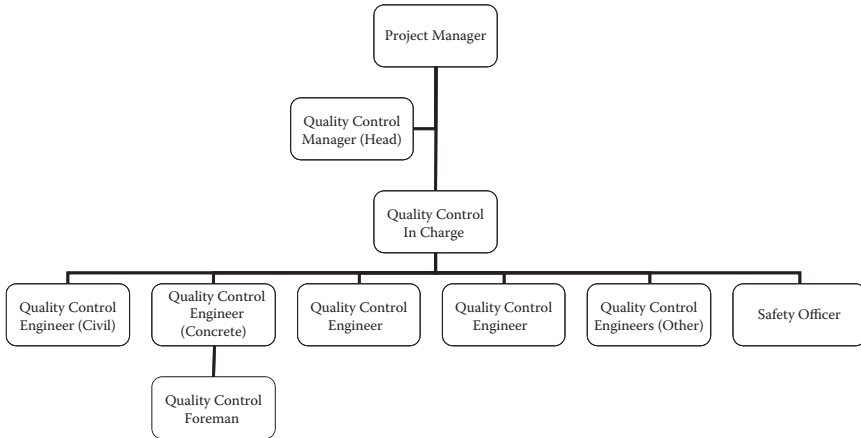

FIGURE C.1
Site quality control organization.

Quality Control Incharge should be responsible to ensure implementation of project quality. He will be supported by quality control engineers as follows:

1. Quality Control Engineer (Civil Works)
2. Quality Control Engineer (Concrete Works)
3. Quality Control Engineer (Mechanical Works)
4. Quality Control Engineer (Electrical Works)
5. Foreman (Concrete Works)

These engineers will be responsible to implement three phases of the quality system at site. Quality Control Incharge will coordinate with the company's head office for all the support and necessary actions. Respective quality control engineers should be responsible to implement the quality program in their respective fields.

4.0 Qualification of QC Staff

All the QC personnel will have adequate experience in their respective fields. Following are the qualifications of each of the quality control staff. Additional staff should be provided if required.

Quality Control Incharge: He should be a qualified civil engineer having minimum 10 years of experience as a quality control engineer in major construction projects.

Quality Control Engineer (Civil Works): Graduate civil engineer with minimum 3 years experience as a quality engineer on similar projects.

Quality Control Engineer (Concrete Works): Graduate civil engineer with minimum 3 years experience as a quality engineer on similar projects.

Quality Control Engineer (Mechanical Works): Graduate mechanical engineer with minimum 3 years experience as a quality engineer on similar projects.

Quality Control Engineer (Electrical Works): Graduate electrical engineer with minimum 3 years experience as a quality engineer on similar projects.

Foreman (Concrete Works): Diploma in civil engineering with minimum 5 years experience as a quality supervisor on similar projects.

5.0 Responsibilities at QC Personnel

Project Manager: Overall project responsibilities.

Quality Control Incharge: He/she should be responsible for the following:

- Preparation of QC plan
- Responsible for overall QC/QA responsibilities
- Responsible for monitoring and evaluation CQP
- Implementation of QC plan
- Responsible for implementing QC procedure
- Maintain QC records and documents
- Inspection of works
- Responsible for offsite inspection
- Inspection of incoming material
- Responsible for subcontractor's QC plan
- Coordinating with safety officer to implement safety plan
- Calibration of measuring instruments
- Monitoring equipment certification

Quality Control Engineers: Each trade should have a responsible quality control engineer to ensure that works are carried out in accordance with the contract documents. Following quality control engineers should be available at site. A foreman will assist the quality control engineer to maintain the quality of concrete works.

1. Quality Control Engineer (Civil Works)
2. Quality Control Engineer (Concrete Works)
3. Quality Control Engineer (Mechanical Works)
4. Quality Control Engineer (Electrical Works)

5. Quality Control Engineer (Other Subcontractors)
6. Foreman (Concrete Works)

The aforementioned personnel should be responsible for following:

- Overall quality of the respective trade
- Preparation of method statement
- Preparation of mock-up
- Monitor and inspect quality of site works
- Inspection of incoming material
- Coordinate with Quality Incharge for preparation of CQP
- Quality control records and documents

6.0 Procedure for Submittals

M/S ABC should be responsible for timely submission of subcontractors, shop drawings, and materials to be used in the project.

6.1 Submittals of Subcontractor(s)

Prior to submission of the subcontractor's name to the owner/consultant M/S ABC should review the capabilities of the subcontractor to perform the contracted works properly per the specified quality and within the time allowed. M/S ABC should also consider the contractor's performance in the previously executed project. Companies implementing a quality management system plan and having ISO certification should be given preference while selecting the subcontractor(s) to work on this project.

6.2 Submittals of Shop Drawings

Before the start of any activity, M/S ABC should submit shop drawings based on contract drawings and other related documents. The number of shop drawings should depend on the requisite details to be prepared against each contract drawings. The shop drawings should be prepared on the agreed format and should have coordination certification from all the trades. All the shop drawings should be submitted through site transmittal for shop drawings. Shop drawing approval transmittals should be numbered serially for each section of the particular specification. M/S ABC should be responsible for shop drawings related to subcontracted works.

6.3 Submittals of Materials

M/S ABC should submit materials, products, and systems for owner's/consultant's approval from the recommended/nominated manufacturers specified in the contract documents. If material is proposed from a nonnominated

manufacturer, then all the documents to justify that the proposed product is approved and equal to the specified should be submitted along with the site transmitted for materials approval.

6.4 Modification Request

If during construction, the contractor observes that some work as mentioned in the contract needs modification, then such a modification request should be submitted to the owner/consultant for their review and approval. Financial obligations should be clearly specified in the request form.

6.5 Construction Program

M/S ABC should prepare and submit a construction program based on the contracted time schedule and submit the same to the consultant for approval. Progress of works should be monitored on a regular basis and the construction program should be updated as and when required to overcome the delay (if any). The following reports should be submitted to the consultant per the following schedule:

1. Daily Report on a daily basis
2. Weekly Report on a weekly basis
3. Monthly Report on a monthly basis
4. Progress Photographs on a monthly basis

7.0 Quality Control Procedure

7.1 Procurement

Prior to placing a purchase order or supply contract with the supplier/vendor, ABC will ensure that the material has been approved and it complies with the requirements of the contract. A procurement log should be maintained for all the items for which action has been taken. The procurement log should be submitted to the owner/consultant every two weeks for review and information.

7.2 Inspection of Site Activities (Checklists)

All the works at site should be performed per approved shop drawings by using approved material. At least three phases of control should be conducted by the Quality Control Incharge for each activity prior to submission of the checklist to the consultant.

These will be

- Preparatory Phase
- Start-up Phase
- Execution Phase

Preparatory Phase: The concerned engineer should review the applicable specifications, references and standards, approved shop drawings and materials, and other submittals (method of statements, etc.) to ensure compliance with the contract.

Start-up Phase: The concerned engineer should discuss with the foreman responsible to perform the work and should establish the standards of workmanship.

Execution Phase: The work should be executed by continuous inspection during this phase.

All the execution/installation works should be carried out per approved shop drawings utilizing approved material. All the works will be checked for quality before submitting the checklist to the consultant to inspect the works.

The following main categories of site works should be performed by conducting the quality control per above-mentioned phases.

7.2.1 Definable Feature of Work

Procedure for scheduling, reviewing, certifying, and managing quality control for a definable feature of work should be agreed upon during the coordination meetings. The definable features of work for concrete should include formwork, reinforcement, and embedded items, design mix, placement of concrete, concrete finishes, etc.

Likewise, the detail list for other trades should be prepared during the coordination meetings. This will consist of embedded conducting works, embedded sleeves, ducts, underground piping, etc.

7.2.2 Earthworks and Site Works

This category should consist of following subgroups:

1. Excavation and backfilling
2. Compaction
3. Dewatering

A checklist should be submitted to consultant at every stage of work, that is, after backfilling and compaction. Samples should be taken to make a compaction test. If the compaction test fails the required specifications, then remedial action should be taken to obtain specified results.

7.2.3 Concrete

M/s (approved subcontractor to supply ready-mix concrete) will provide ready-mix concrete for entire concrete structured works of the project. M/s (ready-mix subcontractor) will have his own quality control system to maintain the mix design.

Reinforcement steel should be inspected upon receipt of material at site for proper size and type, and the factory test certificates received with the supply. Small pieces of sample should be taken from each lot and size for laboratory testing. The testing should be performed by an approved testing laboratory.

Formwork and the reinforcement steel process should be performed under a qualified civil engineer and foreman. Both will be continuously inspecting the work for each operation should be submitted to the consultant for their approval.

Placement of concrete should be supervised by the civil engineer along with the foreman and other team members. The respective consultant will witness concrete casting and take concrete samples during casting for laboratory testing and crushing tests. Slump tests should be performed on the concrete to verify the strength. Curing should be supervised by the respective foreman.

In case the test results does not comply with the specification limit, the results should be discussed with the consulting engineer. Failing tests will be followed by appropriate corrective (reworking) efforts, and retesting and remedial measures.

M/S ABC should maintain all the records, laboratory tests, and results regarding the concrete works and submit the same to the consultants for their information.

7.2.4 Masonry

The concrete block bricks used on the project should be procured from the approved source. Material for mortar aggregate and other accessories such as inserts, reinforcement material, wire mesh, etc., should be submitted to the consultant for approval.

Prior to the start of masonry work, all the related and coordinated drawings should be reviewed. Marking should be made for masonry layout. Necessary mockups should be submitted for each type of unit masonry work. A checklist should be submitted for visual and other type of inspection.

7.2.5 Metal Works

Metal fabrication and installation work should be carried out by certified welders, per manufacturer's recommendations, and per approved shop drawings. Samples of fittings, brackets, fasteners, anchors, and different types of metal members including plates, bars, pipes, tubes, and any other type of material to be used in the project should be submitted to the consultants prior to start of fabrication works at site. Finishing material such as primer and paint should be submitted for approval to the consultant/owner.

In case the fabrication is carried out at the subcontractor(s)'s workshop, then ABC should take full responsibility to control the quality.

A checklist should be submitted at different stages of work to ensure compliance with the specifications and to avoid any rework at the end of completion of fabrication and installation.

7.2.6 Wood Plastics and Composite

Prior to the start of any wood work, the material should be physically and visually inspected for the timber quality to confirm its compliance with the type of the approved material and also to ensure that the wood is free

from decay and insects, and that necessary treatment has already been done on the wood to be used for the project. A product certificate signed by the woodwork manufacturer certifying that the products comply with specified requirements should be submitted along with material submittal. All types of fasteners and other hardware to be used should be submitted for approval per applicable standards, and checklists should be submitted at various stages of work prior to applying the paint or any other finishes.

7.2.7 *Doors and Windows*

This category should consist of the following subcategories:

1. Wooden doors and windows
2. Steel doors
3. Aluminum windows
4. Glazing

All doors and windows should be fabricated from a specified type and material and per approved shop drawings.

Fire-rated types of doors should comply with relevant standards and local regulations.

Samples of materials used in fabrication of doors and windows should be submitted to the consultant/owner for approval.

Wooden doors and windows should be fabricated at an approved subcontractor for carpentry works and aluminum doors and windows should be fabricated at an approved subcontractor for aluminum works. Finishes should be as approved by the owner/consultant. Samples of ironmongery coating material and finishing material should be submitted for approval. Special care should be taken to maintain the acoustic nature of doors and their sound transmission properties.

Glass and glazing material should be submitted for approval and should take care of heat transfer properties to maintain the inside temperature of the building. The glass used in the project should comply with specified strength, safety, and impact performance requirements.

Inspection at different stages should be arranged by field inspection at the factory.

The entire fabrication should be carried out under supervision of ABC to control the quality of finished products.

Doors and windows fabrication should be coordinated for security requirements. Mockups should be prepared before start of installation work.

7.2.8 *Finishes*

This category should consist of the following subgroups:

1. Acoustic ceiling
2. Specialty ceiling

3. Masonry flooring
4. Tiling
5. Carpet
6. Wall cladding
7. Wall partitioning
8. Paints and coating

All the finishes should be as specified and approved. Execution of finishing work should be coordinated with all other trades. Samples and mock-ups should be submitted for approval before start of any finishing work. All the finishing work should be performed by skilled workmen. Specialist subcontractor(s) should be submitted for approval to carryout finishing works. Quality control should be under direct supervision of ABC.

7.2.9 *Landscape*

Landscape work should be executed by a specialist-approved subcontractor per the approved shop drawings under direct supervision of ABC. Samples of each and every type of plant, tree, etc., should be submitted for approval. Soil preparation should be done per specified standards.

7.2.10 *Furnishing*

All the furnishing should be from the specified recommended manufacturer. Special care should be taken to protect the furnishings. Furnishing material sample(s) should be submitted for approval. Fabrication of furniture should be at the approved subcontractor's factory. ABC should be responsible for controlling the quality.

7.2.11 *Equipment*

This category should consist of the following subgroups:

1. Maintenance equipment such as window and facade cleaning
2. Stage equipment
3. Parking control equipment
4. Kitchen equipment

All the equipment should be from specified manufacturers. If the items specified are commercial items—that is, the materials are manufactured and sold to the public as against the materials made to specifications—necessary precaution should be taken to verify that materials should be installed per manufacturer's recommended procedure under the supervision of a qualified engineer.

Items to be manufactured per contract documents should be procured from the manufacturer producing products complying with recognized quality standards. The product and manufacturer's data should be submitted for

approval with all the technical details. Installation of the equipment should be carried out by skilled workmen under supervision of the manufacturer's authorized representative and under the control of ABC.

7.2.12 Conveying System

This category consists of the following subgroups:

1. Passenger elevators
2. Goods elevators
3. Kitchen elevators
4. Escalators

Prior to submission of shop drawings, full technical details along with the catalogues and compliance statement should be submitted for approval. The elevators should be from one of the recommended manufacturers specified in the contract documents.

Fabrication of conveying systems should comply with relevant codes and standards as applicable. Regulatory approval should be obtained from local authorities for installation of the conveying systems to assure their compliance with local codes and regulations.

Finishing material for the cab, landing door, car control station, and car position indicator should be submitted for approval.

Coordinated factory shop drawings should be submitted for approval. Size of shaft and door openings should be coordinated during structural work. Necessary tests should be performed by the manufacturer's authorized personnel.

Factory fabrication works should be performed per the manufacturer's quality control plan, and installation at site should be carried out by personnel authorized by the manufacturer.

Third-party inspection should be arranged per specification requirements.

7.2.13 Mechanical Works

This category should consist of the following subgroups:

1. Fire suppression
2. Water supply, plumbing, and public health
3. HVAC

Mechanical works should be executed by approved mechanical subcontractor. All the works should be carried out per approved shop drawings using approved material.

A mechanical engineer from the subcontractor should be responsible for controlling the quality of work. A quality control engineer (mechanical works) should coordinate all quality-related activities on behalf of ABC. Fire

suppression or firefighting equipment should be carried out per approved drawings by the relevant authority. Materials should be from the manufacturers approved by the relevant authority having jurisdiction over such materials. Fire pumps and firefighting materials should comply with regulatory requirements.

Piping for water supply, plumbing, and public health should be installed with approved material. Leakage and pressure tests should be performed as specified.

Checklists should be submitted after installation of piping, accessories, and fixing of equipment. Drainage systems should be executed per approved shop drawings.

HVAC works should be supervised by a qualified mechanical engineer. Ductwork and duct accessories should be fabricated at the subcontractor's workshop and should be installed at site per approved shop drawings. A mechanical engineer from subcontractor should be responsible to control the quality at the workshop. A quality control engineer (mechanical works) should coordinate all quality-related activities on behalf of ABC. Duct material should be submitted for approval prior to start of fabrication works. Chilled/hot water piping should be from the approved manufacturer. Installation of piping should be carried out by certified pipe fitters.

Selection of HVAC pumps should be done with the help of performance curves and technical data from the pump manufacturer. Chillers should be from the specified manufacturer.

Installation of chillers should be carried out per manufacturer's recommendation.

7.2.14 Automation System

Automation work should be carried out under supervision of a specialist engineer. The system should be from the specified manufacturer.

Shop drawings and schematic diagrams should be submitted for approval configuring approved components/items/equipment.

7.2.15 Electrical Works

This category should consist of the following subgroups:

1. Electrical lighting and power
2. Fire alarm system
3. Communication system (telephone)
4. Public address system
5. Access control and security system
6. Audio visual system
7. MATV system
8. Emergency generating system

All types of electrical works should be executed by an approved electrical subcontractor. All the materials/products to be used should be from the specified manufacturer and should be installed by skilled workmen under the supervision of a qualified engineer.

An electrical engineer from the subcontractor should be responsible to control the quality at the workshop. A quality control engineer (electrical works) should coordinate all quality-related activities on behalf of ABC. Work should be carried out per approved shop drawings. Quality of the works should be controlled at different stages such as after installation of conducting/raceways, pulling of wires/cables, and installation of accessories/equipment/panels. Works should comply with the specifications and recognized codes and standards.

Specified tests should be performed at every stage. Coordination will be done with other trades to assure that required power supply for their equipment will be available at designated locations.

Checklists should be submitted after completion of activities at each stage.

Work not accepted or rejected should be repaired/reworked or replaced and checklist should be resubmitted.

Guarantees and warranties for installed products/items should be submitted per contract requirements during handover of the project.

7.3 Inspection and Testing Procedure for Systems

The QC procedure for systems (low voltage/low current) and their equipment/components should be performed in the following stages.

The proposed manufacturer's complete data giving full details of the capability of the proposed manufacturer to substantiate compliance with the specifications and to prove that the proposed manufacturer is following quality management system and producing the product to recognized quality standards as specified should be submitted. Components/equipment data should be submitted for all the specified items of the system.

A schematic diagram configuring all the items for the system should be submitted along with a detailed technical specification and confirmation from the manufacturer that it complies with the contract documents and is equal or better than the specified products.

Shop drawing(s) fully coordinating with other trades, showing the system location, and the raceways used for installation of the system should be submitted.

All the work at site should be submitted for inspection at different stages of execution of work.

Cable testing should be performed prior to installation of equipment. Checklists should be submitted to the consultant to witness these tests.

Installation of equipment should be done per manufacturer's recommendations and per approved installation methods.

Checklists along with testing procedures should be submitted prior to inspect final inspection and testing.

7.4 Off-Site Manufacturing, Inspection, and Testing

QC procedures for off-site manufacturing/assembling should be per contract documents. Factory control inspection for items fabricated or assembled should be carried out to comply with all the specified requirements and standards under the responsibility of QC personnel at the fabrication/assembly plant. Specified tests should be carried out per the manufacturer's quality procedures and per specification requirements. Test reports for items fabricated/assembled off-site should be submitted along with the delivery of material at site. Witnessing/observation of inspection and tests by the consultant/client, if it is required per specifications, should be arranged. Procedure for such tests and inspection should be submitted in advance of factory/plant visit.

Quality control for off-the-shelf items should be standard quality control practices followed by the manufacturer.

7.5 Procedure for Laboratory Testing of Materials

M/S ABC should submit name(s) of testing laboratories for approval for performing tests specified in the contract documents.

7.6 Inspection of Material Received at Site

All the material received at site should be submitted for inspection by the consultant. A material on site inspection request (MIR) should be submitted to the consultant. Prior to dispatch of material from the manufacturer's premises, all the tests should be carried out, and test certificates should be submitted along with the MIR. Apart from this, all the relevant documents such as the packing list, delivery note, certificate of compliance to recognized standards, country of origin, and any other documents should be submitted along with the MIR.

Material received at the site should be properly stored at designated locations and should maintain original packing until its installation/use.

Inventory records should be maintained for all the material stored at the site. In case of materials to be directly installed at the site upon its receipt, the inspection should be carried out before its use or installation on the project.

In case of concrete ready mix, samples will be tested per contract documents before pouring the concrete for castings.

Specified tests should be performed after delivery of material at site.

7.7 Protection of Works

All the works should be protected at site per specified methods in the contract documents.

7.8 Material Storage and Handling

M/S ABC should arrange for a storage facility on the project site to keep the material in safe condition. Material at site should be fully protected from damages and properly stored. Necessary care should be taken to store paints and liquid types of materials by maintaining appropriate temperature to prevent damage and deterioration of such products. Materials, products, and equipment should be properly packed and protected to prevent damage during transportation and handling.

8.0 Method Statement for Various Installation Activities

Method statement should be submitted to the consultant for their approval per the contract documents. The method statement should describe the steps involved for execution/installation of work by ensuring safety at each stage. It should have the following information:

1. Scope of Work: Brief description of work/activity
2. Documentation: Relevant technical documents to undertake this work/activity
3. Personnel Involved
4. Safety Arrangement
5. Equipment and Plant Required
6. Personal Protective Equipment
7. Permits/Authorities' Approval to Work
8. Possible Hazards
9. Description of the Work/Activity: Detail method of sequence of each operation/key steps to complete the work/activity

Figures C.2–C.9 are illustrative examples of the method of sequence for major activities, for different trades, performed during the construction process.

9.0 Project-Specific Procedures for Site Work Installations Remedial Notice

Quality control for such installations should be as specified in the contract documents or as mentioned in the instructions.

Remedial notices received should be actioned immediately and replied to inspect the works having corrected/performed per contract documents. Similarly nonconformance report should be actioned and replied.

All repaired and reworked items should be inspected by the concerned engineer and quality control engineer before submitting a "Request for Inspection" or "Checklist."

Appropriate preventive actions should be taken to avoid repetition of non-conformance work. The following steps should be taken to deal with any problem requiring preventive action:

- Detect
- Identify the potential causes
- Analyze the potential causes

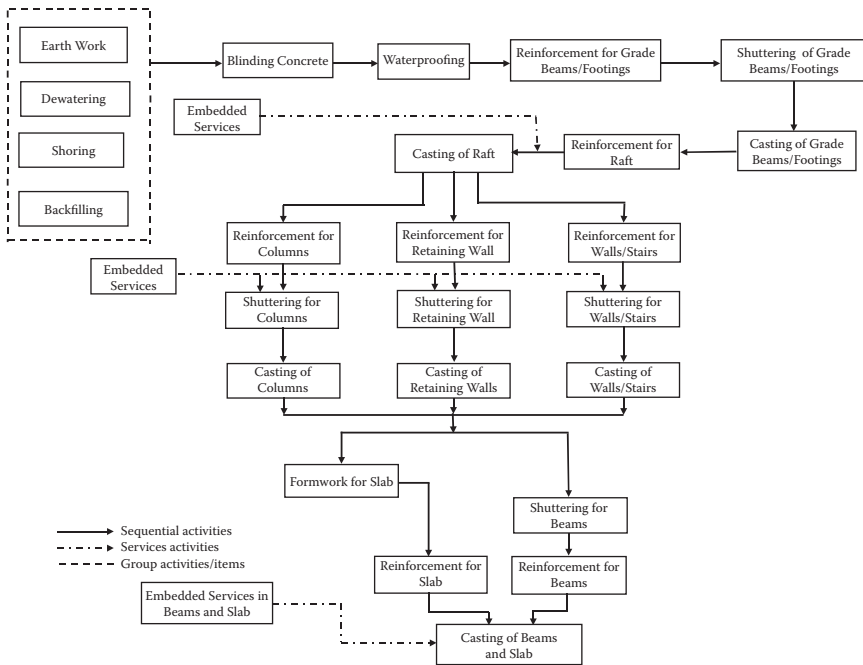

FIGURE C.2 Method of sequence for concrete structure work.

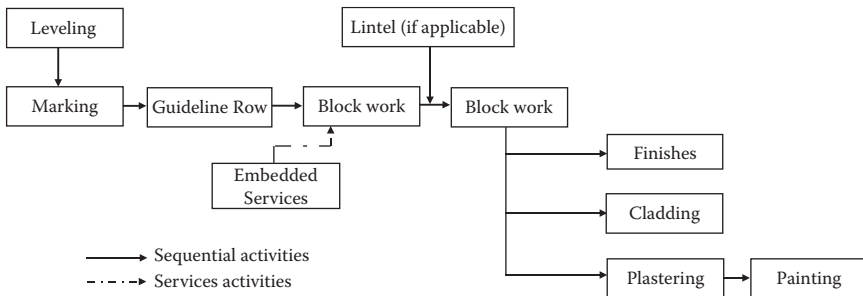
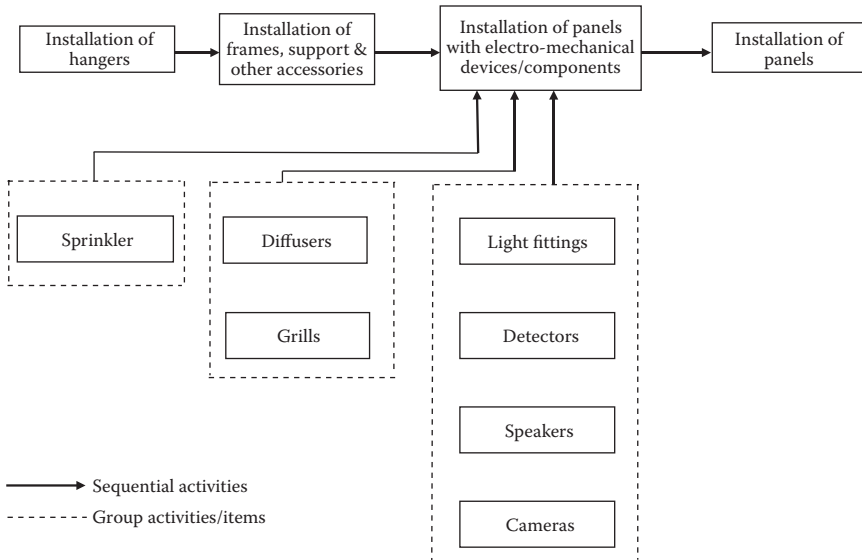

FIGURE C.3 Method of sequence for block masonry work.

**FIGURE C.4**

Method of sequence for false ceiling work.

- Eliminate the potential causes
- Ensure the effectiveness of preventive action

10.0 Quality Control Records

Quality control records should be maintained by the Quality Control Incharge and should be accessible to authorized personnel for review and information. The records should include

- Contract drawings and revisions
- Contract specifications and revisions
- Approved shop drawings
- Record drawings
- Material approval record
- Checklists
- Test reports
- Material inspection reports
- Minutes of quality control meetings
- Site works instructions
- Remedial notes
- Other records specified in the contract documents or as requested by the owner/consultant

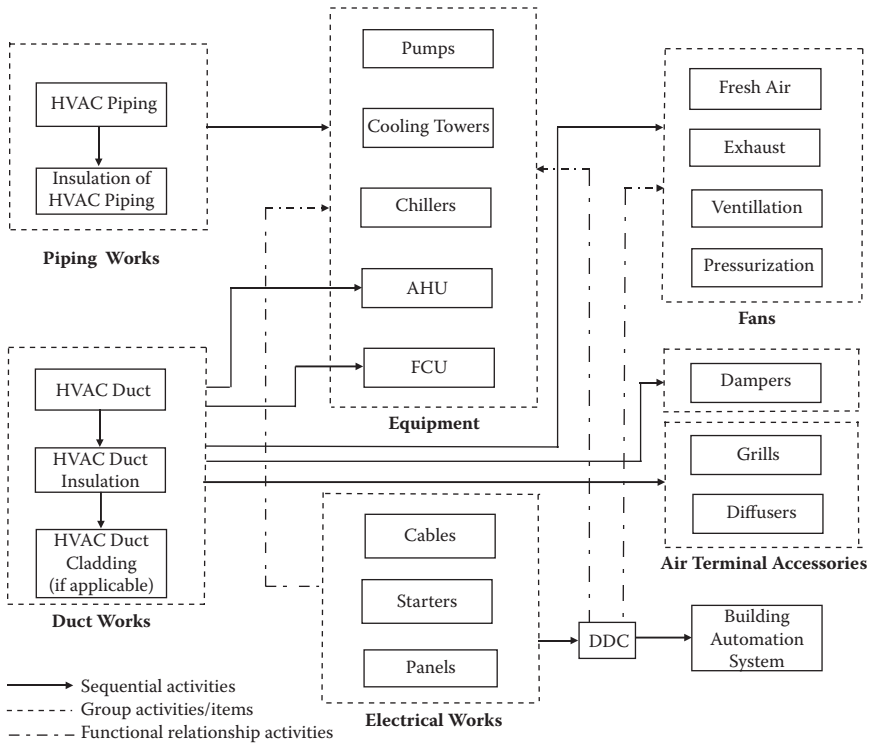

FIGURE C.5
Method of sequence for HVAC work.

11.0 Company's Quality Manual and Procedures

The following documents from the company's manual should be part of contractor's Quality Control Plan.

1. Documents for specific projects
2. Subcontractor evaluation
3. Supplier evaluation
4. Client supplied items
5. Receiving inspection and testing
6. Site inspection and testing
7. Final inspection, testing, and commissioning
8. Material storage and handling
9. Control of quality records
10. Internal audit

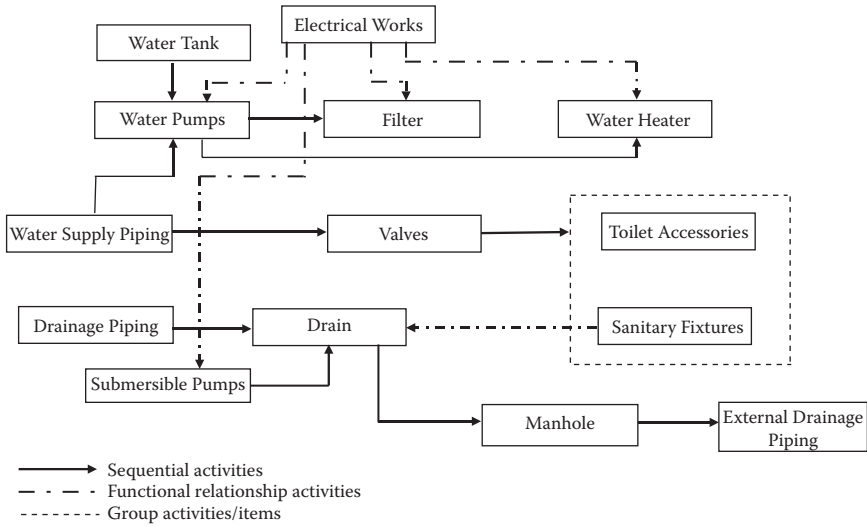

FIGURE C.6
Method of sequence for mechanical work (public health).

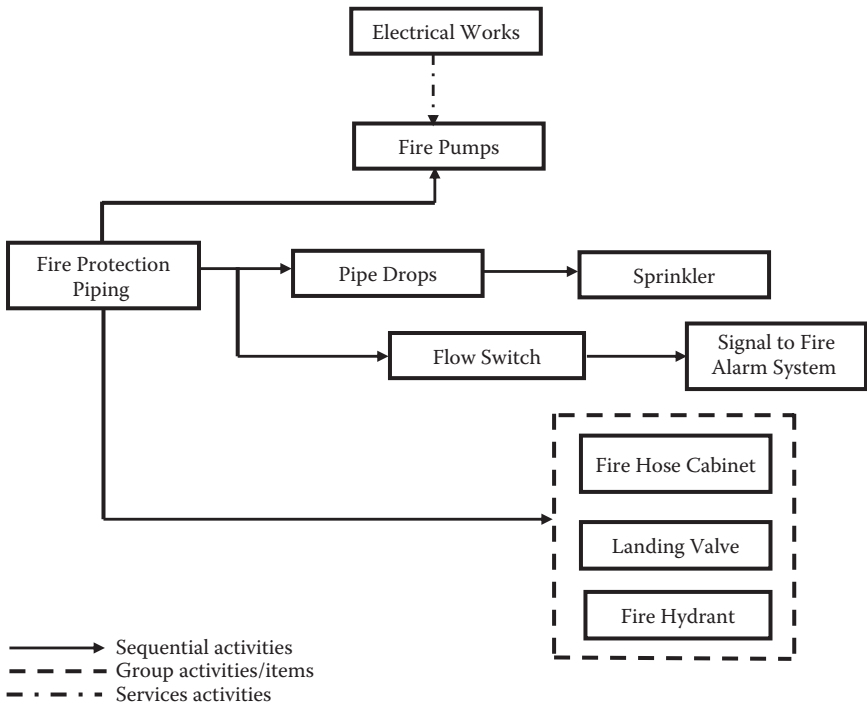

FIGURE C.7
Method of sequence for mechanical work (fire protection).

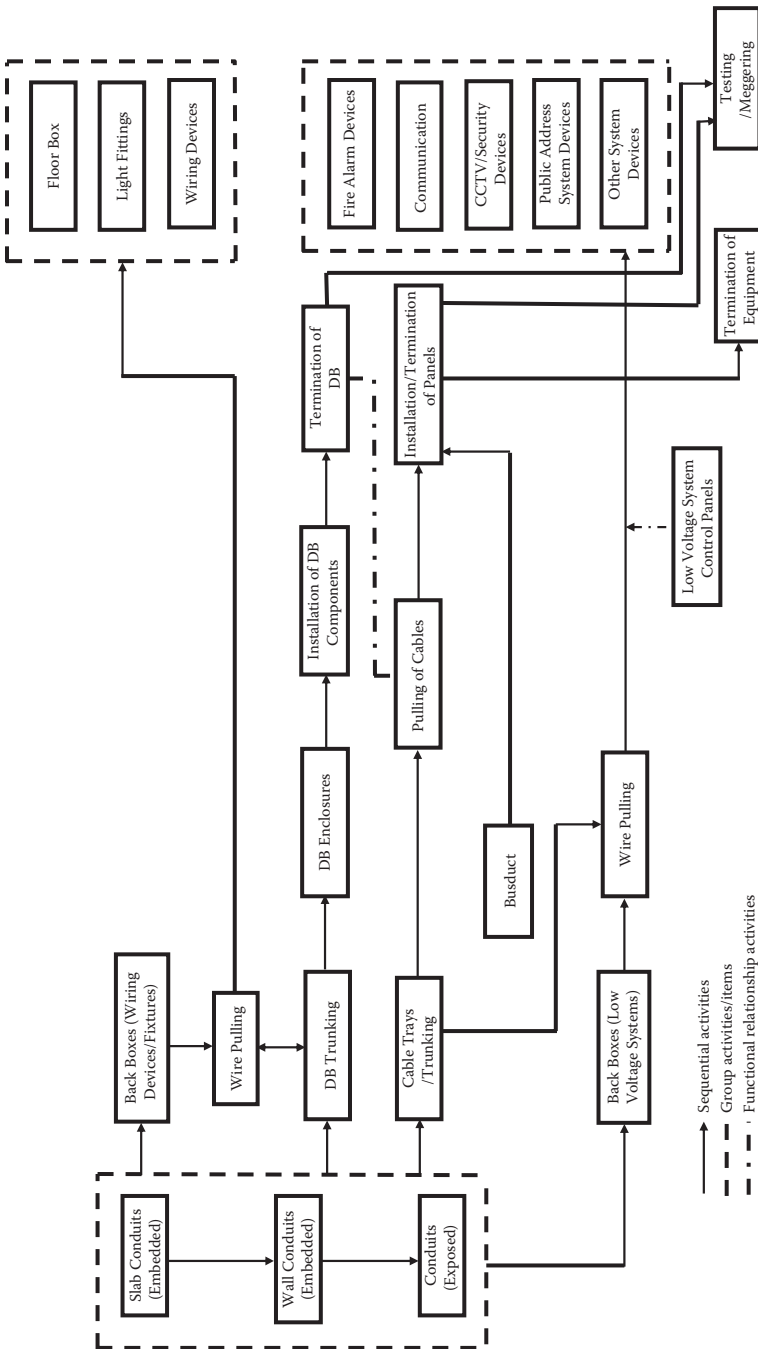

FIGURE C.8 Method of sequence for electrical work.

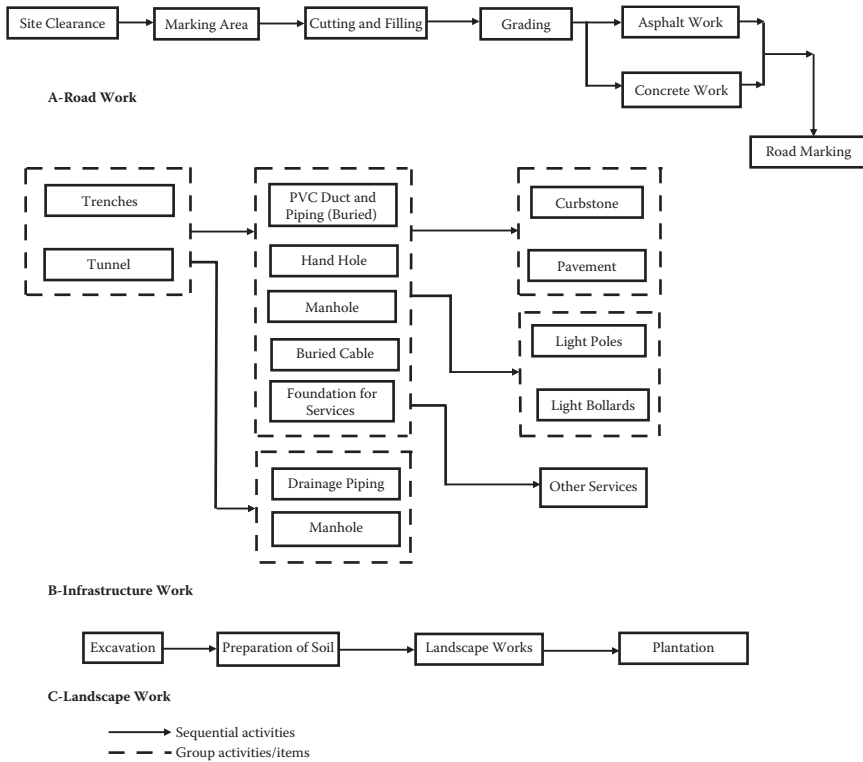

FIGURE C.9
Method of sequence for external works.

12.0 Periodical Testing of Construction Equipment

Hoists, cranes, and other lifting equipment used at site should be tested periodically by third-party inspection authority and test certificates should be submitted to the consultant. Measuring instruments should have calibration tests performed by the approved testing agencies/government agencies at regular intervals, and a calibration certificate should be submitted to consultants. Other equipment should be tested/calibrated per contract requirements and per the schedule for such tests.

13.0 Quality Updating Program

The quality control program should be reviewed every 6 months and necessary updates should be done, if required. All such information should be given to the consultants and a record should be made for such revisions.

14.0 Quality Auditing Program

Internal auditing should be performed by the company's internal auditor to ensure that specified quality procedures are followed by the site quality personnel.

15.0 Testing, Commissioning, and Handover

The test should be carried out per contract documents. Necessary test procedures should be submitted prior to start of testing of installed systems/equipment.

Engineers from the respective trades will be responsible for arranging orderly performance of testing and commissioning of the systems/equipment.

16.0 Health, Safety and the Environment

The HSE officer should be responsible for implementing health and safety measures per OHSAS 18000 and the project's environmental requirements per local regulatory authority. ABC should prepare and submit a health and safety management and accident prevention program. The safety program should embody the prevention of accidents, injuries, occupational illnesses and property damage. All personnel at the site should be provided with safety gear. Regular meetings and awareness training should be conducted at the site on a regular basis. ABC should ensure that first aid and emergency medical facilities are available at the site all the time. ABC should comply with all safety measures specified in the contract documents. ABC should take all necessary measures to comply with regulatory requirements and environmental considerations.

Bibliography

- Alexander, K. (1996). *Facilities Management: Theory and Practice*. London: E & FN SPON Press.
- American Society of Civil Engineers. (2000). *Quality in the Constructed Project: A Guide for Owners, Designers, and Constructors*, Second edition. Reston, Virginia: American Society of Civil Engineers.
- American Society for Quality. (2007). Quality basics, <http://www.asq.org>.
- Ashford, J L. (1989). *The Management of Quality in Construction*. London: E & FN SPON.
- Balanchard, B.S., and Fabrycky, W.J. (1998). *Systems Engineering and Analysis*, Third edition. Upper Saddle River, New Jersey: Prentice-Hall.
- Bennet, F.L. (2003). *The Management of Construction: A Project Life Cycle Approach*. Oxford, U.K.: Butterworth-Heinemann.
- Chase, R., Aquilano, N., and Jacobs, F. (2001). *Operations Management for Competitive Advantage*, Ninth edition. New York: Irwin, McGraw-Hill.
- Chung, H.W. (1999). *Understanding Quality Assurance in Construction: A Practical Guide to ISO 9000 for Contractors*. London: E & FN SPON.
- Construction Industry Institute. (February 1990). The Quality Performance Management System. CII Publication 10-3. Austin, Texas: University of Texas.
- Construction Industry Institute. (April 1990). Total Quality Management: The Competitive Edge. CII Publication 10-4. Austin, Texas: University of Texas.
- Construction Industry Institute. (November 1990). *Potential for Construction Industry Improvement: Volume 1*. CII Source Document 61. Austin, Texas: University of Texas.
- Construction Industry Institute. (June 1992). *Guidance for Implementing Total Quality Management in Engineering and Construction Industry*, CII Source Document 74. Austin, Texas: University of Texas.
- Construction Industry Institute. (October, 1992). *Quality Performance Measurement of EPC Process*. CII Source Document 79. Austin, Texas: University of Texas.
- Construction Industry Institute. (1994). *Quality Performance Management System: Measurement*. CII Product No. EM-4A. Austin, Texas: University of Texas.
- Corrie, R.K. (1991). *Engineering Management Project Evaluation*. London: Thomas Telford Ltd.
- Crosby, P.B. (1979). *Quality Is Free: The Art of Making Quality Certain*. New York, McGraw-Hill.
- Dell'Isola, A.J. (1997). *Value Engineering: Practical Applications for Design, Construction, Maintenance and Operations*. Kingston, Massachusetts: RSMMeans.
- Deming Institute, (2000). *Out of the Crisis*. www.deming.org,
- Feigenbaum, A.V. (1991). *Total Quality Control*, Third edition. New York: McGraw-Hill.
- Gryna, F.M. (2001). *Quality Planning and Analysis*, Fourth edition. New York: Irwin, McGraw-Hill.
- Institution of Civil Engineers. (1996). *Civil Engineering Procedure*. London: Thomas Telford Ltd.

- International Council on Systems Engineering, <http://www.incose.org>.
- International Organisation for Standardisation, from ISO, <http://www.iso.org>.
- Ireland, L.R. (1991). *Quality Management for Projects and Programs*. Newtown Square, Pennsylvania: PMI.
- Ishikawa, K. (Translated by David J. Lu). (1985). *What Is Total Quality Control? The Japanese Way*. Englewood Cliffs, New Jersey: Prentice-Hall.
- Juran, J.M., and Godfrey, A.B. (1999). *Juran's Quality Handbook*, Fifth edition, New York: McGraw-Hill.
- Kerzner, H. (2001). *Project Management: A Systems Approach to Planning, Scheduling and Controlling*, Seventh edition. New York: John Wiley & Sons.
- Keuhn, A.A. and Day, R.L. (1954). Strategy of product quality. *Harvard Business Review*, Nov.–Dec., p. 831.
- MasterFormat 2004, The Construction Specifications Institute and Construction Specification, Canada. <http://www.csi.com>.
- Oakland, J.S. (2003). *TQM*. Oxford, UK: Butterworth-Heinemann.
- Oberlender, G.D. (2000). *Project Management for Engineering and Construction*. Singapore: McGraw-Hill.
- Oswald, T.H. and Burati, Jr., J.L. Construction Industry Institute. (January 1989) Cost of Quality Deviation in Design and Construction, Publication 10-1. Austin, Texas: University of Texas.
- Project Management Institute. (2000). *A Guide to the Project Management Body of Knowledge (PMBOK)*. Newtown Square, Pennsylvania: PMI.
- Pyzdek, T. (1999). *Quality Engineering Handbook*. Boca Raton, Florida: CRC Press.
- Ritz, G.J. (1990). *Total Engineering Project Management*. New York: McGraw-Hill.
- Sebestyen, G. (1998). *Construction-Craft to Industry*. London: Spon Press SAVE International (The Value Society <http://www.value-eng.org>).
- Shtub, A., Bard, J.F., and Globerson, S. (1994). *Project Management: Engineering, Technology and Implementation*. Upper Saddle River, New Jersey: Prentice Hall.
- Stevenson, T. H., and Barnes, F. C. (2001). Fourteen years of ISO 9000: Impact, criticism, costs, and benefits. *IEEE Engineering Management Review*, 29 (4), 2001.
- Tague, N.R. (2005). *The Quality Toolbox*, Milwaukee. Wisconsin: American Society for Quality Press.
- Thorpe, B., Sumner, P., and Duncan, J. (1996). *Quality Assurance in Construction*. Surrey, U.K.: Gower Publishing Ltd.
- Turner, J.R. (2003). *Contracting for Project Management*. Surrey, UK: Gower Publishing Ltd.
- Sullivan, W.G., Wicks, E.M., and Luxhoj, J.T. (2003). *Engineering Economy*, Twelfth edition. Upper Saddle River, New Jersey: Prentice Hall.

Concise and easy to read, **Quality Management in Construction Projects** presents key information on how to approach quality assurance for construction projects. Containing quick reference tables and a wealth of figures, the book presents valuable quality-related data and guidelines. It provides coverage that spans the inception of a project through issuance of a completion certificate.

Go the extra distance and become the consummate professional:

- Learn about different types of contract deliverable systems
- Explore important points to be considered while developing detailed design and shop drawings
- Plan for major activities during construction process
- Check lists for design review
- Anticipate costs involved with quality
- Understand reasons why an executed work may be rejected
- Develop ways to assess your quality efforts

In addition to covering standard procedures and concepts, the author introduces and discusses a wide range of the state-of-the-art-tools and approaches that professionals can use to develop an Integrated Quality Management System most suitable for their specific project. These include Six Sigma, TRIZ, and Total Quality Management, as well ISO 9000, the ISO 14000 Environmental Management System, and OHSAS 18000.

This information will also prove valuable for cutting-edge instructors who wish to provide engineering/management students with in-depth knowledge about current practices and familiarize them with the vernacular used in discussing quality assurance practices within the construction industry.

K11759



CRC Press
Taylor & Francis Group
an informa business

www.crcpress.com

6000 Broken Sound Parkway, NW
Suite 300, Boca Raton, FL 33487
270 Madison Avenue
New York, NY 10016
2 Park Square, Milton Park
Abingdon, Oxon OX14 4RN, UK

ISBN: 978-1-4398-3871-6

90000



9 781439 838716