

Schneider Electric wiring devices, lighting & air movement

LifeSpace Product catalogue



Electrical solutions

Smart home

An innovative range of affordable home automation systems. From Sphere programmable lighting control system, LexCom Performance networking system, to Ulti wireless luxury, Schneider Electric will add a new dimension to modern home living.

Wiring accessories

Schneider Electric provide a comprehensive range of wiring accessories that guarantee quality, flexibility, safety and performance with practical features that save the installer time and energy.

Lighting

Lighting plays a key role in contemporary design providing the right mood at the right time. The range includes LED rated downlights, low energy lighting, T4 and T5 mini battens and amenity drum lighting.

Ventilation & heating

Effective air movement equals comfort and hygiene for homes and offices alike. With contemporary styling in mind, recent additions to the Cyclone range of aluminium and glass panel extractor fans help to complement a range of interiors.



Look for energy saving products throughout this edition

Contents



Smart home

Sphere wireless lighting system.....	6-9
ULTI wireless lighting system	10-13
LexCom Performance networking system.....	14-17



Wiring accessories

Ultimate range.....	20-87
Exclusive range.....	88-119
Weatherproof range	120-133



Lighting

Indoor.....	136-151
Outdoor and amenity	152-157



Ventilation & heating

Cyclone – Extractor fans.....	160-163
Warm air, portable and fixed.....	164-167

Technical information	169-194
-----------------------------	---------

Alpha code index.....	195
-----------------------	-----



For more information call us on 0870 608 8 608
or click on www.schneider-electric.co.uk

Intelligence in the home





Smart Home

Smart Home technology will add a new dimension to modern home living and entertaining, whether in one room or multiple rooms.

Sphere wireless lighting system can be fully operational in a few easy steps. The system can be extended at any time, making it the perfect solution for those who want a flexible future from their lighting control.

ULTI wireless lighting is quick and easy to install. Designed to be completely retrofittable and operating with wireless transmission, no costly and troublesome rewiring is required.

LexCom Performance is an all-in-one residential networking system. The system provides access to TV, radio, phone and data services from any LexCom Performance outlet.

Sphere wireless lighting system

Controllers.....	8
Replacement face plates.....	8
Receivers.....	9

ULTI wireless lighting system

Switches.....	12
Dimmer switches.....	12
Lamp dimmer.....	12
Freelocate switches, remote & repeater.....	13
Socket outlets.....	13
Communication outlets.....	13

LexCom Performance

Core unit.....	16
Cable.....	16
Outlet connector.....	16
Triple play.....	16
Dedicated cords & accessories.....	17

Technical information.....	170-178
-----------------------------------	----------------



Sphere wireless lighting system

How does it work section

Sphere operates by sending a coded wireless signal from a controller to the wired-in circuit receiver units discreetly located into the ceiling, or under furniture when used with portable lighting. The receivers can be mounted inline, which enables table lamps, uplighters and other lighting outputs to be incorporated into the complete lighting solution.

Total control at your fingertips

At the push of a button, the light levels can be controlled to meet the desired ambience. The wall controllers have a choice of interchangeable front plates, and fully complement Schneider Electric's Ultimate range, with the ability to be mounted to any surface and require no wiring, making installation simple and straightforward

Simplicity at its best

Sphere requires no complicated software or specialist installation, which means programming couldn't be simpler

A world of possibilities

There is no limit to the number of receivers that can be installed in each property, so every room could potentially be controlled individually.

Receivers can operate up to 30 metres away from the controller, offering flexibility for the homeowner.



GSWWDR30



GSWCRR5A



GSWFDR35



GSW10VFLDR

Receivers

- For use with a wide range of lights and control equipment
- Relay receivers suitable for fluorescent lighting loads, LED lighting loads, as well as a wide range of other equipment, e.g. extractor fans etc
- Ceiling receiver designed for use with LV halogen, mains halogen and incandescent loads
- Colour coded terminals
- BS EN 60669-2-1-2000
- Mains operation
- Loads:
 - Dimmable receiver - 350VA (20W/VA min. load)
 - Relay receiver - 5A (2A motor load)
 - Wall dimmable receiver - 300W/VA (50VA/60W min load)
 - Fluorescent dimmable receiver - 1-10V control

Part number	Description	Qty
GSWWDR30	Wall dimmable receiver - 300W/VA*	1
GSWFDR35	Floor dimmable receiver - 350VA	1
GSWCRR5A	Ceiling dimmable receiver - 350VA	1
GSWCRR5A	Ceiling relay receiver - 5A	1
GSW10VFLDR	Ceiling fluorescent dimmable receiver - 1-10V	1

* Minimum mounting depth 25mm two wire connection

Redefining Lighting



With its ultra-clean lines, sleekly chic square profile, the award winning **ULTI** is instantly identifiable

ULTI lets you set the perfect lighting. The push of a button is all it takes to activate one-touch scene control and recalls your favourite pre-programmed combination of lights and light intensity. Expandable, easy to upgrade and to programme, ever adaptable ULTI redefines the art of fine lighting.



ULTI wireless lighting system

RF boundless communications

As all ULTI switches incorporate patented radio frequency (RF) enabled wireless receivers, you can seamlessly integrate the operation of all automated lights within 4,000 square feet via just one remote control. Unlike conventional line-of-sight Infra Red (IR) systems, ULTI also enables you to wirelessly control your pre-programmed lighting scenes through solid walls.

A TruRetrofit lighting control

Eliminating neutral wires and rewiring dramas, ULTI's patented EZinstall Wireless Technology can be easily installed in around five minutes.

Unlike other lighting control systems, you simply remove your original switch and upgrade to an EZinstall replacement. ULTI's true retrofitability even enables the instant automation of older buildings.

Expandable, flexible

Designed with distributed intelligence, ULTI is astonishingly easy to upgrade. Every lighting point is controlled through an individual remote controller, thus eliminating rewiring hassles. ULTI's expandability also gives you flexibility to add switches and dimmers to meet your needs as your space evolves.

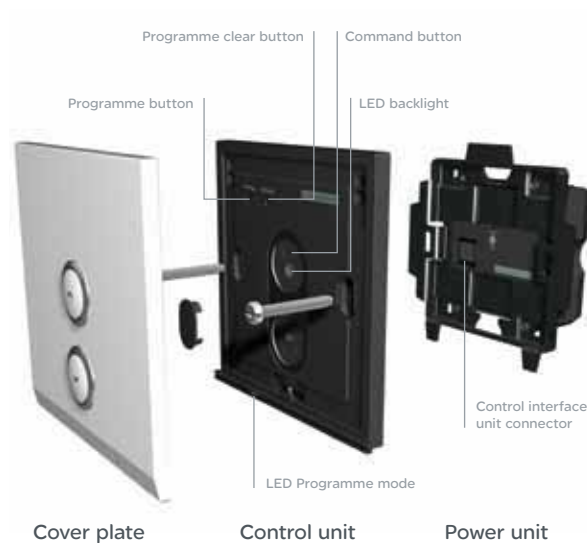



Crystal glass

Switches

- 100/240V
- 1 gang = 2000VA
- 2 gang = 2 x 1000VA
- 50/60Hz
- Mounting box depth: 35mm
- Decor spacer should be used where existing box depth insufficient. (transparent grey)
- Capacitor for specific lamp types where minimum load requirements are not met.

Part number	Description	Qty
U201SRY2KW001	1G switch module 2000VA 240V (module only)	1
UC21SW***	1G switch cover	1
U202SRY2KW001	2G switch module 2000VA 240V (module only)	1
UC22SW***	2G switch cover	1
UAX001	Decor spacer for switches and dimmers (8 & 15mm)	1
UAX004	0.47uF load capacitor	1



Champagne gold

Dimmer switches



- 200/240V
- 1 gang = 600VA
- 2 gang = 2 x 300VA
- 50/60Hz
- Mounting box depth: 35mm
- Decor spacer should be used where existing box depth insufficient. (transparent grey)

Part number	Description	Qty
U201DST600001	1x600VA 240V Dimmer (Module Only)	1
UC21DM***	1G Dimmer Cover plate	1
U202DST600001	2x300VA 240V Dimmer (Module Only)	1
UC22DM***	2G Dimmer Cover plate	1
UAX001	Decor spacer for switches and dimmers (8 & 15mm)	1



Lamp dimmer



- 13A socket with clip on remote
- 200/240V
- 50/60 Hz

Part number	Description	Qty
U101DFR400XBL1	400W lamp dimmer set with remote control	1

Note Replace *** with suffix code to denote cover plate finish:
XPW Pearl white **XGL** Crystal glass
XCG Champagne gold **XBS** Brushed silver



Freelocate switches, remote & repeater

■ 100m range (subject to conditions, see technical pages).

Part number	Description	Qty
U105RHH001BPW1	5 key hand held remote 1 control Pearl White	1



Brushed silver

■ Freelocate supplied as complete item

■ 100m range (subject to conditions, see technical pages)

Part number	Description	Qty
U102RWM001***1	2 key 2 scene Freelocate switch	1
U106RWM001***1	6 key 5 scene Freelocate switch	1
UAX003	Black lockable bracket	1



■ Built in RF receiver and transmitter extends RF signal coverage of remote units and Freelocate switches

■ BS 13A socket

■ 220/240V

Part number	Description	Qty
U10XARR001210	RF Repeater pearl white	1



Crystal glass

Socket outlets

■ LED outlets are supplied with amber or blue illumination on the push switch mechanism to co-ordinate with the selectable blue or amber backlight on ULTI switches and dimmers

Part number	Description	Qty
US15A00	1G 13A switched socket amber LED (module only)	1
US15B00	1G 13A switched socket blue LED (module only)	1
UC15***	1G socket cover	1
UST25A00	2G 13A switched socket amber LED (module only)	1
UST25B00	2G 13A switched socket blue LED (module only)	1
UCT25***	2G socket cover	1
US155A00	1G 5A switched socket amber LED (module only)	1
US155B00	1G 5A switched socket blue LED (module only)	1
UC155XGL	1G 5A socket cover crystal glass	1
U201SPMDPB00	1G 16A DP switch amber/blue LED (module only)	1
UC21DPPXGL	1G 16A switch cover crystal glass	1



Crystal glass

Communication outlets

■ RJ45 CAT 6

Part number	Description	Qty
US31RJ000	1G RJ45 socket (module only)	1
UC31RJ***	1G RJ45 cover plate	1
US32TD000	2G RJ45 socket (module only)	1
UC32TD***	2G RJ45 cover plate	1
US31TV000	TV outlet (module only)	1
UC31TV***	TV outlet cover plate	1



Crystal glass

Note Replace *** with suffix code to denote cover plate finish:

XPW Pearl white

XCG Champagne gold

XGL Crystal glass

XBS Brushed silver

Flexibility
in the home



LexCom Performance networking system

The flexible multimedia choice

LexCom Performance is a good choice if you have an active interest in modern home technology and computers. You will get a network solution with a great capacity and multimedia access from all outlets thanks to the Triple play device.

Fast to install and easy to expand

LexCom Performance makes the installation easy and fast. Just put the central core unit with its 8 outgoing links, somewhere in the home. From there, a single cable carries the three separate signals for TV, phone and data to every outlet in every room.

Plug & Triple play

With a Triple Play Splitter, all outlets can be turned into a Multimedia hub. Just plug the Splitter in and the outlet can be used for phone, broadband or TV. This will make digital boxes, extension cords and cross connections obsolete. It is truly a flexible connectivity, eliminating inconveniences and creating more freedom.

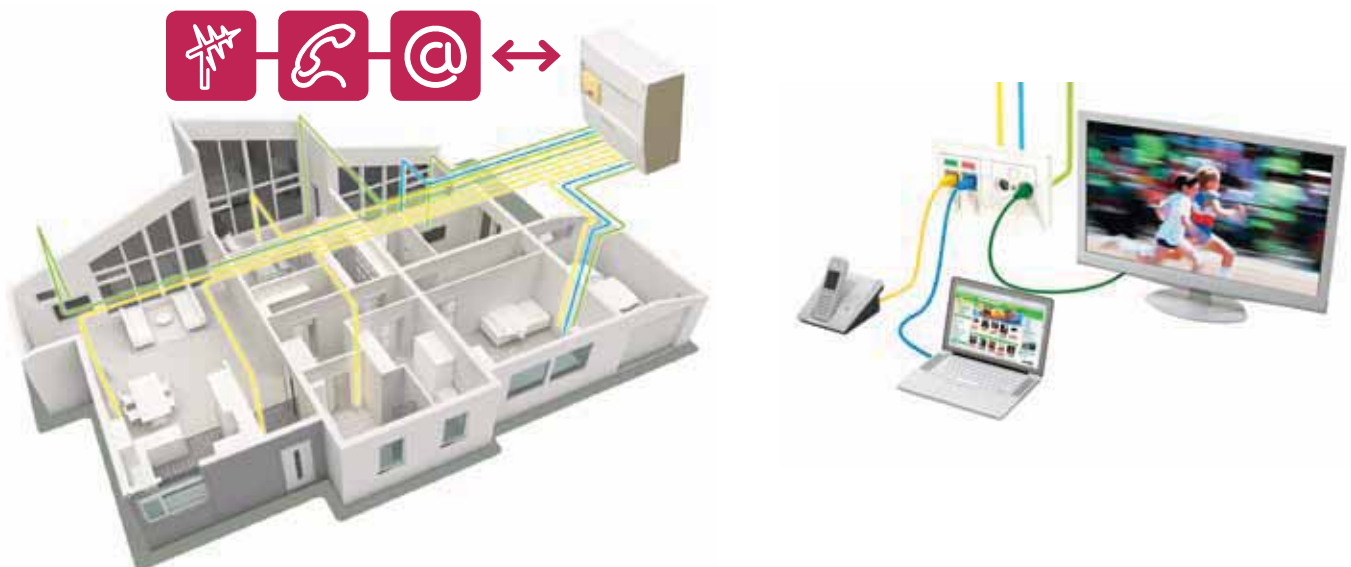



Core system

Distribution of voice, data & image signals

- 2 RJ11 telephone lines
- 8 data ports RJ45 STP
- Gain forward -5/ +15dB
- Tilt (equaliser): +/- 6db
- Input voltage 12 Vdc
- Dimension: 300 x 250 x 90 mm
- Weight: 500g

Part number	Description	Qty
VDIR528010	Active central processing unit	1



Cable

LexCom Performance installation cable, S/STP

- 4 twisted pairs individually shielded S/STP
- White outer jacket (RAL 9010), LSFROH
- International colour coding

Part number	Description	Qty
VDIR534830	Cable white box – 120m	1
VDIR534810	Cable white drum – 300m	1



Outlet connector

RJ45 jack for LexCom Performance terminal outlets

- Screened wide band connector STP
- Does not require tool for wiring
- International colour coding

Part number	Description	Qty
VDI552012	LexCom Performance STP connector	1



Part number	Description	Qty
GU8450**	Ultimate screwless 1 module Euro plate Dimensions: 88 x 88mm (1 module)	1
GU8550**	Ultimate low profile 1 module Euro plate Dimensions: 88 x 88mm (1 module)	1
GU8050	Ultimate moulded 1 module Euro plate Dimensions: 86 x 86mm (1 module)	1
GEURO1	Exclusive moulded 1 module Euro plate Dimensions: 86 x 86mm (1 module)	1



To order a complete unit requires:

- LexCom Performance connector
- Outlet module
- Euro plate

Part number	Description	Qty
GUE7091*	LexCom Performance data outlet module	8



Triple play

- Enables all 3 services to be used simultaneously from one outlet
- 1 in RJ45 3 out RJ45 (supplied with 3m input cord)
- Flame retardant PVC black cable
- Balun in the RJ45 plug

Part number	Description	Qty
VDIR593001	Triple play splitter	1
VDIR647402	Triple play input cord 0.5m	1

Note Replace * with suffix code to denote colour required:

W White **B** Black

Note Replace ** with suffix code to denote plate finish required:

SS Stainless steel **PN** Pearl nickel **PC** Polished chrome
PW Painted White **PB** Polished brass **BN** Black nickel

Dedicated cords and accessories



Connection cord between the wall outlet and the TV or Radio equipment

- Mixed cord TV/R IEC (male) / RJ45 with superior shielding construction
- Flame retardant PVC black cable
- Balun in the RJ45 plug
- Female IEC adapter included for Radio
- Provided in 3 meter length

Part number	Description	Qty
VDIR643003	TV/Radio cord	1



Connection and patch cord for data application

- 2 pairs straight wiring
- RJ45 to RJ45 screened cord
- PVC grey cable
- Overmoulded RJ45 plug

Part number	Description	Qty
VDIR547402	Data cord, 0.5m	1
VDIR547403	Data cord, 1m	1
VDIR547404	Data cord, 2m	1
VDIR547405	Data cord, 3m	1
VDIR547406	Data cord, 5m	1



Stacking cord to daisy chain two LexCom Performance units

- Mixed cord RJ11 / RJ45 unscreened
- PVC black cable
- Overmoulded RJ45 plug
- Provided in 1 meter length

Part number	Description	Qty
VDIR542111	Stacking cord	1
VDIR580021	Cable jacket stripper	1



The tool kit provides a small range of tools especially adapted, it includes:-

- 1 cable jacket stripper
- 1 LSA punch down tool
- 1 flat screw driver for gain adjust
- 1 cross screw driver for overall mounting
- 1 wrench key for F-conn

Part number	Description	Qty
VDIR580020	Tool kit	1



A test system to verify the installation work and to enable correct configuration of the installation

- Allows the 8 links to be tested
- Tests the wire map (continuity and shorts)
- Tests cable link length adjustments for TV output level
- Powered by LexCom Performance core unit

Part number	Description	Qty
VDIR580010	Test kit	1

Something
for every home





Wiring Accessories

Schneider Electric provide a comprehensive range of wiring accessories that guarantee quality, flexibility, safety and performance with the practical features that save the installer time and energy.

Ultimate range

Slimline white moulded	21-28
Part M solutions	29-33
Screwless flat plate	34-51
Flat plate	52-63
Low Profile	64-68
Euro plates & modules	69-71
Grid	72-82
Rocca	83-87

Exclusive range

Square edge white moulded	89-94
Decorative	95-98
Metal clad	99-102
E-Series polycarbonate	103-110
T2 ceiling accessories	111-116
Occupancy sensors	117-119

Weatherproof

IP55 & IP66	120-124
Kavacha	125-126
56 Series	127-133

Technical information	179-187
-----------------------------	---------



Ultimate slimline white moulded

Ultimate slimline white moulded wiring accessories offer a stylish, modern alternative.

Aesthetically pleasing and ultra-slim, these sleek fittings make for ease of installation with their subtle curved profile and minimum back projections.

The range, which includes euromodular and grid variants, was designed to complement the Ultimate screwless and flat plate ranges for situations where a combination of fittings may be required.

Features & benefits:

Consumer

- > An ultra-slim plate for minimum projection when flush fitted
- > Curved rockers with tactile switch action
- > Slim-line, compact neons for a less obtrusive look
- > Screw cap covers provide a sleek finishing touch

Installer

- > Minimal back projection for both new and retrofits (switches 16mm, sockets 25mm)
- > Unique integral locking facility on isolator for added safety
- > Fully rated switches at 10AX for fluorescent and inductive loads
- > Colour coded in-line terminals make selection even easier
- > Double pole options on 1-gang and 2-gang switched sockets (twin-earth terminals on 2 gang sockets)
- > All fuse carriers are lockable to prevent accidents during maintenance
- > Plated earth straps assist longevity for a corrosion free life



GU3050

13A unswitched socket outlets

- Dimensions: 86 x 86mm (1 gang), 86 x 146mm (2 gang)
- Mounting box:
 - SB251 (F) GU9125 (S) – 1 gang
 - SB351 (F) GU9135 (S) – 1 gang
 - SB252 (F) GU9225 (S) – 2 gang
 - SB352 (F) GU9235 (S) – 2 gang
- Fix screws: M3.5 x 30mm
- BS 1363

Part number	Description	Qty
GU3050	1 gang unswitched	10
GU3060	2 gang unswitched	5



GU3021

13A SP switched socket outlets

- Dimensions: 86 x 86mm (1 gang), 86 x 146mm (2 gang)
- Mounting box:
 - SB251 (F) GU9125 (S) – 1 gang
 - SB351 (F) GU9135 (S) – 1 gang
 - SB252 (F) GU9225 (S) – 2 gang (limited cable access)
 - SB352 (F) GU9235 (S) – 2 gang
- Fix screws: M3.5 x 30mm
- BS 1363

Part number	Description	Qty
GU3010	1 gang switched	10
GU3011	1 gang switched with neon	10
GU3020	2 gang switched	5
GU3021	2 gang switched with neons	5



GU3010D

13A DP switched socket outlets

- Dimensions: 86 x 86mm (1 gang), 86 x 146mm (2 gang)
- Mounting box:
 - SB251 (F) GU9125 (S) – 1 gang
 - SB351 (F) GU9135 (S) – 1 gang
 - SB252 (F) GU9225 (S) – 2 gang (limited cable access)
 - SB352 (F) GU9235 (S) – 2 gang
- Fix screws: M3.5 x 30mm
- BS 1363

Part number	Description	Qty
GU3010D	1 gang DP switched	10
GU3020D	2 gang DP switched	5

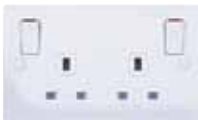

GU3030

13A DP outboard rocker switched socket outlets

- Dimensions: 86 x 146mm (2 gang)
- Mounting box:
 - SB252 (F) GU9225 (S) – 2 gang (limited cable access)
 - SB352 (F) GU9235 (S) – 2 gang
- Fix screws: M3.5 x 30mm
- BS 1363 (where applicable)

Part number	Description	Qty
GU3030	2 gang switched	5
GU3031	2 gang switched with clean earth	5
GU3032	2 gang switched red with rockers, clean earth and neons	5
GU3033	2 gang switched with clean earth and non standard	5
GU3034	2 gang switched with red rockers, clean earth, non standard and neons	5

Turn to page 29 to view our full range of Part M solutions.

Note All 2 gang sockets include twin earth terminals as standard, enabling high integrity earthing. To aid flush installation 35mm steel boxes are recommended.



GU3080

Round pin socket outlets

- Dimensions: 86 x 86mm
- Mounting box:
 - SB251 (F) GU9125 (S) – 1 gang
- Fix screws: M3.5 x 30mm
- BS 546

Part number	Description	Qty
GU3070	2A unswitched	10
GU3080	5A unswitched	10
GU3090	15A switched	10
GU3091	15A switched with neon	10



GU1012



GU1013

10AX plate switches

- Dimensions: 86 x 86mm (1-3 gang), 86 x 146mm (4-6 gang)
- Mounting box:
 - SB161 (F) GU9116 (S) 1-2 gang
 - SB251 (F) GU9125 (S) 3 gang
 - SB252 (F) GU9225 (S) 4-6 gang
- Fix screws: M3.5 x 18mm
- * 10A rated only
- BS EN 60669-1
- BS EN 60947-3 (GU1013)

Part number	Description	Qty
GU1011	1 gang 1 way	10
GU1012	1 gang 2 way	10
GU1012R	1 gang 2 way retractive*	10
GU1012RP	1 gang 2 way retractive marked press*	10
GU1012RB	1 gang 2 way retractive marked with bell symbol*	10
GU1022	2 gang 2 way	10
GU1032	3 gang 2 way	10
GU1042	4 gang 2 way	5
GU1062	6 gang 2 way	5
GU1013	3 pole isolator	10
GU1014	1 gang intermediate	10

16AX wide rocker switches



GRWH1012

- Dimensions: 87 x 87mm
- Mounting box:
 - SB251 (F) GU9125 (S)
- Fix screws: M3.5 x 25mm
- * 10AX rated only
- BS EN 60669-1

Part number	Description	Qty
GRWH1012	1 gang 2 way	10
GRWH1022	2 gang 2 way	10
GRWH1032A	3 gang 2 way	10
GRWH1014	1 gang intermediate*	10

10AX architrave switches



GU1012A

- Dimensions: 33 x 86mm (1 gang), 33 x 148mm (2 gang)
- Mounting box:
 - SBA251A (F) GPAT1G16A (S) 1 gang
 - SBA252A (F) GPAT2G16A (S) 2 gang
- Fix screws: M3.5 x 18mm
- BS EN 60669-1

Part number	Description	Qty
GU1012A	1 gang 2 way architrave	10
GU1022A	2 gang 2 way architrave	10

Turn to page 29 to view our full range of Part M solutions.



GU6032

Mains dimmer switches



- Dimensions: 86 x 86mm (1-2 gang), 86 x 146mm (3-4 gang)
- Mounting box:
 - SB161 (F) GU9116 (S) 1-2 gang
 - SB252 (F) GU9225 (S) 3-4 gang
- Fix screws: M3.5 x 30mm
- BS EN 60669-2-1

Part number	Description	Qty
GU6011	1 gang 1 way 400W rotary	1
GU6012	1 gang 2 way 400W push	1
GU6022	2 gang 2 way 250W push	1
GU6032	3 gang 2 way 250W push	1
GU6042	4 gang 2 way 250W push	1



GU6022LV

Low voltage dimmer switches



- Dimensions: 86 x 86mm (1-2 gang), 86 x 146mm (3-4 gang)
- Mounting box:
 - SB161 (F) GU9116 (S) 1-2 gang
 - SB252 (F) GU9225 (S) 3-4 gang
- Fix screws: M3.5 x 30mm
- BS EN 60669-2-1

Part number	Description	Qty
GU6011LV	1 gang 1 way 400VA rotary	1
GU6012LV	1 gang 2 way 400VA push	1
GU6022LV	2 gang 2 way 250VA push	1
GU6032LV	3 gang 2 way 250VA push	1
GU6042LV	4 gang 2 way 250VA push	1



GU2014WH

20AX & 32A DP switches and flex outlet plates

- Dimensions: 86 x 86mm
- Mounting box:
 - SB251 (F) GU9125 (S)
- Fix screws: M3.5 x 30mm
- BS EN 60669-1

Part number	Description	Qty
GU2010	20A DP	10
GU2011	20A DP with neon	10
GU2013	20A DP with flex outlet	10
GU2014	20A DP with neon and flex outlet	10
GU2014WH	20A DP with flex outlet and neon marked water heater	10
GU4031	32A 1 gang DP switch with neon	10



GU2003

- BS 5733

Part number	Description	Qty
GU2033	25A side entry flex outlet plate	10
GU2003	20A front entry flex outlet plate	10

Note: Mains dimmer switches are not suitable on low voltage circuits. See technical section. 1 and 2 gang 2 way dimmer switches include spacing frame for mounting in plaster depth 16mm boxes.

*1 way dimmers can be used to replace standard wall switches and retrofit into 16mm mounting box.



GU5000

13A unswitched fused connection units

- Dimensions: 86 x 86mm
- Mounting box:
 - SB251 (F) GU9125 (S)
- Fix Screws: M3.5 x 30mm
- BS 1363

Part number	Description	Qty
GU5000	13A unswitched	10
GU5001	13A unswitched with neon	10
GU5003	13A unswitched with flex outlet	10
GU5004	13A unswitched with neon & flex outlet	10
GU50003	3A unswitched	10
GU50033	3A unswitched with flex outlet	10



GU5014

13A switched fused connection units

- Dimensions: 86 x 86mm
- Mounting box:
 - SB251 (F) GU9125 (S)
- Fix Screws: M3.5 x 30mm
- BS 1363

Part number	Description	Qty
GU5010	13A DP switched	10
GU5011	13A DP switched with neon	10
GU5013	13A DP switched with flex outlet	10
GU5014	13A DP switched with neon & flex outlet	10

Ultimate engraved range

	20A DP Control switch				13A Fused connection unit		
	DP switch	DP with neon	DP with flex outlet	DP with flex outlet & neon	Unswitched	Switched	Switched with neon
Air conditioner			GU2013AC	GU2014AC			
Boiler						GU5010BO	GU5011BO
Cooker hood						GU5010CH	GU5011CH
Dish washer						GU5010DW	GU5011DW
Extractor fan						GU5010EF	GU5011EF
Fan						GU5010FA	GU5011FA
Freezer						GU5010FZ	GU5011FZ
Fridge						GU5010FR	GU5011FR
Fridge/freezer						GU5010FFZ	GU5011FFZ
Hob						GU5010HO	GU5011HO
Heater	GU2010HT	GU2011HT	GU2013HT	GU2014HT	GU5000HT	GU5010HT	GU5011HT
Microwave					GU5000MW	GU5010MW	GU5011MW
Oven	GU2010OV	GU2011OV					
Security					GU5000SS		
Towel rail		GU2011TR	GU2013TR		GU5000TR		
					GU5003TR*		
Tumble dryer					GU5000TD	GU5010TD	GU5011TD
Waste disposal					GU5000WD	GU5010WD	GU5011WD
Washing machine						GU5010WM	GU5011WM

* GU5003TR includes flex outlet



GU4011



GU4021

45A DP switches

- Dimensions: 86 x 86mm (1 gang), 146 x 86mm (2 gang)
- Mounting box:
 - SB471 (F) GU9147 (S)
 - SB472 (F) GU9247 (S)
- Fix screws: M3.5 x 30mm
- BS EN 60669-1

Part number	Description	Qty
GU4010	45A 1 gang DP	10
GU4011	45A 1 gang DP with neon	10
GU4020	45A 2 gang DP	5
GU4021	45A 2 gang DP with neon	5

45A DP cooker control units



GU4001

- Dimensions: 86 x 86mm (1 gang), 86 x 146mm (2 gang)
- Mounting box:
 - SB471 (F) GU9147 (S) 1 gang
 - SB472 (F) GU9247 (S) 2 gang
- Fix screws: M3.5 x 30mm
- BS 4177

Part number	Description	Qty
GU4000	45A DP cooker control unit & 13A switched socket	5
GU4001	45A DP cooker control unit & 13A switched socket with neons	5
GU4050	Cooker connection unit	10

Shaver socket



GU7090

- Dimensions: 146 x 86mm
- Mounting box:
 - SB472 (F) GU9247 (S)
- Fix screws: M3.5 x 30mm
- BS EN 61558-2-5

Part number	Description	Qty
GU7090	115/230V dual voltage shaver socket	1

Telephone outlets



GU7062

- Dimensions: 86 x 86mm
- Mounting box:
 - SB251 (F) GU9125 (S)
- Fix screws: M3.5 x 30mm
- BS EN 41003

Part number	Description	Qty
GU7051	Single gang RJ11 outlet	10
GU7061	Single gang telephone master	10
GU7062	Single gang telephone secondary	10



GU7071

Data outlets

- Dimensions: 86 x 86mm
- Mounting box:
 - SB251 (F) GU9125 (S) single/twin
 - SB352 (F) GU9235 (S) quad
- Fix Screws: M3.5 x 30mm
- CAT5e
- BS EN 41003

Part number	Description	Qty
GU7071	Single gang RJ45 outlet	10
GU7072	Twin gang RJ45 outlet	10
GU7074	Quad RJ45 outlet	5



GU7030

TV outlets

- Dimensions: 86 x 86mm
- Mounting box:
 - SB251 (F) GU9125 (S)
- Fix Screws: M3.5 x 30mm
- BS 3041 (where applicable)

Part number	Description	Qty
GU7010	Single gang tv/fm co-axial	10
GU7020	Twin gang tv/fm co-axial	10
GU7030	Single gang satellite	10
GU7040	Twin gang satellite/co-axial	5



GU7081

Screened TV outlets

- Dimensions: 86 x 86mm
- Mounting box:
 - SB251 (F) GU9125 (S)
- Fix Screws: M3.5 x 30mm
- BS 3041 (where applicable)
- See technical section

Part number	Description	Qty
GU7021	Single gang duplex TV/FM	10
GU7081	Single gang triplex TV/FM/SAT	10



GU8010

Blank plates & replacement screw capped covers

- Dimensions: 86 x 86mm (1 gang), 86 x 146mm (2 gang)
- Fix screws: M3.5 x 30mm
- BS 5733

Part number	Description	Qty
GU8010	1 gang blank plate	10
GU8020	2 gang blank plate	10
GUMSCO	Moulded screw capped covers	100



GU9116

Surface pattresses

- BS 5733
- All supplied complete with earth terminals

Part number	Description	Qty
GU9116	1 gang 16mm	10
GU9125	1 gang 25mm	10
GU9225	2 gang 25mm	5
GU9D25	Dual 25mm	5
GU9135	1 gang 35mm	10
GU9235	2 gang 35mm	5
GU9147	1 gang 47mm	10
GU9247	2 gang 47mm	5
GPAT1G16A	1 gang 16mm architrave	10
GPAT2G16A	2 gang 16mm architrave	10



GU8080

Euro modular plates

- Dimensions: 86 x 86mm (1-2 module), 86 x 146mm (4 module)
- Refer to module for appropriate mounting box depth

Part number	Description	Qty
GU8050	1 module	10
GU8060	2 module	10
GU8080	4 module	5



GUE7010W

Euro modular plates

- Dimensions: 25 x 50mm (single), 50 x 50mm (double)
- Mounting box:
 - 1 module: SB251 (F) 1 gang
SB252 (F) 2 gang
 - 2 module: SB351 (F) 1 gang
SB352 (F) 2 gang

Part number	Description	Module size	Qty
GUE7010W	TV/Radio diplexer	2	1
GUE7011W	Single IEC coax (female)	1	1
GUE7012W	Single IEC coax (male)	1	1
GUE7030W	Single F type sat	1	1
GUE7040W	TV/Sat diplexer	2	1
GUE7081W	TV/FM/Sat triplexer	2	1
GUE7082W	TV/FM/Sat 1/Sat 2 quadplexer	2	1
GUE7020W	HDMI	2	1
GUE7051W	RJ11 modem	1	1
GUE7061W	Telephone (BT master)	1	1
GUE7062W	Telephone (BT secondary)	1	1
GUE7071W	RJ45 CAT5e (not screened)	1	1
GUE7072W	RJ45 CAT6 (not screened)	1	1
GUE7075W	VGA	1	1
GUE7091W	LexCom Performance outlet	1	8
GUE7000W	2 x Phono socket	1	1
GUE7001W	2 x Loudspeaker socket	1	1
GUE8010W	Blank module	1	5



GUE7030W



GUE7061W

Part M solutions

Part M of the Buildings Regulation 2000, took effect on 1st May 2004 for England and Wales, sets out requirements and guidelines covering access to, and use of, buildings and its facilities to meet the requirement highlighted in the Disability Discrimination Act (DDA) 2005.

Practical advice on elements such as provision of wide doorways and appropriate sanitary facilities are covered by this regulation.

Part M specifically highlights the use of switches, outlets and controls, giving guidance on four main product elements:

- > Ease of operation
 - > Visibility
 - > Height
 - > Freedom from obstruction
-



Features & benefits:

- > Contrasting coloured rockers, to improve visibility of switches and sockets
- > Switches with larger rockers and sockets that have wider gaps between rockers, to ease operation
- > Grey or red coloured bangles to improve visibility and to aid operation of lighting
- > Engraved products to help identify electrical switches and their application
- > Colour contrasting grid plates providing additional flexibility
- > Grooved socket to direct the plug into the earth terminal
- > Solutions to use with cable management
- > Range of red devices for applications which call for equipment to identify essential or critical supply

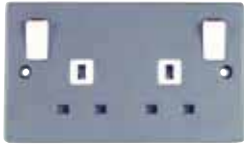

GU3030GY

13A socket outlets

- Dimensions: 86 x 86mm (1 gang), 86 x 146mm (1 gang)
- Mounting box:
 - SB251 (F) 1 gang
 - SB351 (F) 1 gang
 - SB252 (F) 2 gang
 - SB352 (F) 2 gang
- Fix screws: M3.5 x 30mm
- BS 1363

Part number	Description	Qty
GU3010DGY	1 gang DP switched - Grey	10
GU3030GY	2 gang DP switched with outboard rockers - Grey	5
GSKTSW2GV	2 gang 'V' grooved locator socket	5



GRWH1022GY

Plate switches

- Dimensions:
 - Standard Rocker 86 x 86mm
 - Wide rocker 87 x 87mm
- Mounting box:
 - Standard rocker SB161 (F) 1-2 gang
SB251 (F) 3 gang & intermediate
SB251 (F) GU9125 (S)
 - Wide rocker SB251 (F) GU9125 (S)
- Fix screws:
 - Standard rocker M3.5 x 18mm
 - Wide rocker M3.5 x 25mm
- BS EN 60669-1

Part number	Description	Qty
GU1012GY	10AX 1 gang 2 way	10
GU1022GY	10AX 2 gang 2 way	10
GU1032GY	10AX 3 gang 2 way	10
GU1014GY	10AX 1 gang intermediate	10
GU1012RGY	10A 1 gang 2 way retractive	10
GRWH1012GY	16AX 1 gang 2 way wide rocker	5
GRWH1022GY	16AX 2 gang 2 way wide rocker	5
GRWH1032GY	16AX 3 gang 2 way wide rocker	5
GRWH1014GY	10AX 1 gang intermediate	5
GRGYWF01	Replacement grey frame for wide rocker range	10



GU2010GY

20AX DP switch

- Dimensions: 86 x 86mm
- Mounting box:
 - SB251 (F) GU9125 (S)
- Fix screws: M3.5 x 30mm
- BS EN 60669-1

Part number	Description	Qty
GU2010GY	DP switched	10



GU5011GY

13A switched fused connection units

- Dimensions: 86 x 86mm
- Mounting box: SB251 (F) GU9125 (S)
- Fix screws: M3.5 x 30mm
- BS 1363

Part number	Description	Qty
GU5010GY	DP switched	10
GU5011GY	DP switched with neon	10

Note: All 2 gang sockets include twin earth terminals as standard, enabling high integrity earthing. To aid flush installation 35mm steel boxes are recommended.

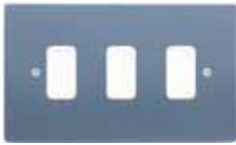

GUG03GGY

Flush moulded front plates

- Supplied with mounting grids
- For a full range of grid modules see page 74
- See page 80 for mounting boxes

Part number	Description	Qty
GUG01GGY	1 module	1
GUG02GGY	2 module	1
GUG03GGY	3 module	1
GUG04GGY	4 module	1



Ceiling pull cord

Part number	Description	Qty
GPULLGY	Grey 1.5m pull cord with single grey bangle	10



DDA cable management plate

Part number	Description	Qty
DDA1BL	1 gang Traffic Blue	10
DDA1CH	1 gang Charcoal Grey	10
DDA2BL	2 gang Traffic Blue	10
DDA2CH	2 gang Charcoal Grey	10



GU3010DRD

Essential supply 13A socket outlets

- Dimensions: 86 x 86mm (1 gang), 86 x 146mm (1 gang)
- Mounting box:
 - SB251 (F) 1 gang
 - SB351 (F) 1 gang
 - SB252 (F) 2 gang
 - SB352 (F) 2 gang
- Fix screws: M3.5 x 30mm
- BS 1363

Part number	Description	Qty
GU3060RD	2 gang unswitched	5
GU3010DRD	1 gang DP switched	10
GU3030RD	2 gang DP switched with outboard rockers	5



GU5000RD

Essential supply 13A fused connection units

- Dimensions: 86 x 86mm
- Mounting box: SB251 (F) GU9125 (S)
- Fix screws: M3.5 x 30mm
- BS 1363

Part number	Description	Qty
GU5000RD	Unswitched	10
GU5010RDW	DP switched	10



Essential supply ceiling pull cord

Part number	Description	Qty
GPULLRD	Red 1.5m pull cord with twin red bangles	10

Note: All 2 gang sockets include twin earth terminals as standard, enabling high integrity earthing. To aid flush installation 35mm steel boxes are recommended.

Exclusive engraved range - 20A DP control switch

	DP switch	DP with neon	DP with flex outlet	DP with flex outlet & neon
Air conditioner			GSWDP20AFOAC	GSWDPN20AFOAC
Heater	GSWDP20AHT	GSWDPN20AHT	GSWDP20AFOHT	GSWDPN20AFOHT
Oven	GSWDP20AOV	GSWDPN20AOV		
Towel rail			GSWDP20AFOTR	GSWDPN20AFOTR

Exclusive engraved range - 13A fused connection unit

	Unswitched	Switched	Switched with neon
Boiler		GSWSPURBO	GSWNSPURBO
Cooker hood		GSWSPURCH	GSWNSPURCH
Dishwasher		GSWSPURDW	GSWNSPURDW
Extractor fan		GSWSPUREF	GSWNSPUREF
Fan		GSWSPURFA	GSWNSPURFA
Freezer		GSWSPURFZ	GSWNSPURFZ
Fridge		GSWSPURFR	GSWNSPURFR
Fridge/freezer		GSWSPURFFZ	GSWNSPURFFZ
Hob		GSWSPURHO	GSWNSPURHO
Heater	GSPURHT	GSWSPURHT	GSWNSPURHT
Microwave		GSWSPURMW	GSWNSPURMW
Security	GSPURSS		
Towel rail	GSPURTR		
Tumble dryer	GSPURTD	GSWSPURTD	GSWNSPURTD
Washer dryer	GSPURWDY	GSWSPURWDY	GSWNSPURWDY
Waste disposal	GSPURWD	GSWSPURWD	GSWNSPURWD
Washing machine	GSPURWM	GSWSPURWM	GSWNSPURWM

Ultimate engraved range - 20A DP control switch

	DP switch	DP with neon	DP with flex outlet	DP with flex outlet & neon
Air conditioner			GU2013AC	GU2014AC
Heater	GU2010HT	GU2011HT	GU2013HT	GU2014HT
Oven	GU2010OV	GU2011OV		
Towel rail		GU2011TR	GU2013TR	

Ultimate engraved range - 13A fused connection unit

	Unswitched	Switched	Switched with neon
Boiler		GU5010BO	GU5011BO
Cooker hood		GU5010CH	GU5011CH
Dish washer		GU5010DW	GU5011DW
Extractor fan		GU5010EF	GU5011EF
Fan		GU5010FA	GU5011FA
Freezer		GU5010FZ	GU5011FZ
Fridge		GU5010FR	GU5011FR
Fridge/freezer		GU5010FFZ	GU5011FFZ
Hob		GU5010HO	GU5011HO
Heater	GU5000HT	GU5010HT	GU5011HT
Microwave	GU5000MW	GU5010MW	GU5011MW
Security	GU5000SS		
Towel rail	GU5000TR GU5003TR*		
Tumble dryer	GU5000TD	GU5010TD	GU5011TD
Waste disposal	GU5000WD	GU5010WD	GU5011WD
Washing machine		GU5010WM	GU5011WM

* GU5003TR includes flex outlet



Ultimate screwless flat plate

Ultimate screwless flat plate provides one of the most comprehensive ranges of beautifully crafted, sleek, sophisticated fittings on the market.

More choice, more style, and packed with innovative technical features for easy installation.

Features & benefits:

Consumer

- > Comprehensive range from dimmer switches to data communication and all control applications
- > Unique 'glow in the dark' optional mounting frame
- > Slimline, compact neons for a subtle effect
- > Curved, matching metal capped rockers that are aesthetically pleasing and easy to operate with a choice of white or black interior
- > Large plate footprint avoids the need for additional decorating on retrofits

Installer

- > Easy-fit screwless front plate simply but securely clips onto the mounting system
- > Even with the front plate removed access to live parts is restricted
- > Large in-line angled colour coded terminals to aid cable insertion and selection
- > Minimal back projection to allow installation using standard flush mounting boxes for both new and retrofits
- > Accessories supplied with both long and short screws for installation flexibility
- > Full 10AX fluorescent rating on all plate switches
- > Double pole options on 1-gang and 2-gang switched sockets (Twin earth terminals on 2-gang sockets)
- > Fully matched grid system



GU3450WSS

13A unswitched sockets

- Dimensions: 88 x 88mm (1 gang), 88 x 148mm (2 gang)
- Mounting box:
 - SB251 (F) 1 gang
 - SB351 (F) 1 gang
 - SB252 (F) 2 gang
 - SB352 (F) 2 gang
- Fix screws: M3.5 x 25mm and 30mm
- BS 1363

Part number	Description	Qty
GU3450***	1 gang	1
GU3460***	2 gang	1



GU3421BPB

13A switched sockets

- Dimensions: 88 x 88mm (1 gang), 88 x 148mm (2 gang)
- Mounting box:
 - SB251 (F) 1 gang
 - SB351 (F) 1 gang
 - SB252 (F) 2 gang
 - SB352 (F) 2 gang
- Fix screws: M3.5 x 25mm and 30mm
- BS 1363

Part number	Description	Qty
GU3410***	1 gang switched	1
GU3411***	1 gang switched with neon	1
GU3420***	2 gang switched	1
GU3421***	2 gang switched with neons	1
GU3410D***	1 gang DP switched	1
GU3420D***	2 gang DP switched	1



GU3431WSS

13A DP outboard rocker switched socket outlet

- Dimensions: 88 x 148mm
- Mounting box:
 - SB252 (F) 2 gang
 - SB352 (F) 2 gang
- Fixed screws: M3.5 x 25mm and 30mm
- BS 1363

Part number	Description	Qty
GU3431***	2 gang switched with clean earth	1
GU3434***	2 gang switched with clean earth, non standard and neons	1



GU3470BPC

Round pin socket outlets

- Dimensions: 88 x 88mm
- Mounting box: SB251 (F)
- Fixed screws: M3.5 x 25mm and 30mm
- BS 546

Part number	Description	Qty
GU3470***	2A unswitched	1
GU3480***	5A unswitched	1
GU3490***	15A switched	1

Note Replace *** with suffix code to denote finish/interior colour required:

WSS Stainless steel with white interior	WPN Pearl nickel with white interior	BPC Polished chrome with black interior
BSS Stainless steel with black interior	BPB Polished brass with black interior	WPC Polished chrome with white interior
WPW Painted white with white interior	WPB Polished brass with white interior	BBN Black nickel with black interior

Media plates

- Dimensions: 178 x 286mm
- Mounting box dimensions: 160 x 270 x 40mm depth
- Fix screws: M3.5 x 25mm and 30mm
- BS 5733
- BS 1363-2



GU3420DWSSMP

Part number	Description	Qty
GU3420DWSSMP	Media plate 4 socket 8 euromodule stainless steel white inserts	1
GU3420DWPWMP	Media plate 4 socket 8 euromodule white metal white inserts	1
GU3420DWPCMP	Media plate 4 socket 8 euromodule polished chrome white inserts	1
GU3420DMP	Media plate mounting box (Flush galv.)	1

10A & 10AX plate switches

- Dimensions: 88 x 88mm (1-3 gang), 88 x148mm (4-6 gang)
- Mounting box: See selection table
- Fix screws: M3.5 x 25mm and 30mm
- BS EN 60669-1
- BS EN 60947-3 (GU1413***)
- The glow in the dark frame discreetly sign-posts the profile of the switch and aids switch location



GU1442WSS



GU1400F

Part number	Description	Qty
GU1412***	1 gang 2 way SP	1
GU1412R***	10A 1 gang 2 way retractive	1
GU1422***	2 gang 2 way SP	1
GU1432***	3 gang 2 way SP	1
GU1442***	4 gang 2 way SP	1
GU1462***	6 gang 2 way SP	1
GU1413***	3 pole isolator	1
GU1414***	1 gang intermediate	1
GU1400F	1 gang glow in the dark frame	10

150W PIR plate switch



- Dimensions: 88 x 88mm (1 gang)
- Mounting box: SB161 (F) 1 gang
- Fix screws: M3.5 x 25mm and 30mm
- 2 wire connection
- Operating distance = 6M at 45° horizontal
- BS EN 60669-2-1
- Stainless steel finish only with black insert
- Time setting: 15 sec - 30 min
- 10 - 2000 Lux



GUPA1411BSS

Part number	Description	Qty
GUPA1411BSS	1 gang 1 way PIR switch with override	1
GUP1411BSS	1 gang 1 way PIR switch	1

10AX toggle switches

- Dimensions: 88 x 88mm (1-3 gang), 88 x148mm (4 gang)
- Mounting box:
 - SB161 (F) 1-2 gang
 - SB351 (F) 3 gang
 - SB252 (F) 4 gang
- Fix screws: M3.5 x 25mm and 30mm
- BS EN 60669-1



GU1422TPB

Part number	Description	Qty
GU1412T**	1 gang 2 way	1
GU1422T**	2 gang 2 way	1
GU1432T**	3 gang 2 way	1
GU1442T**	4 gang 2 way	1

Note Replace *** with suffix code to denote finish/interior colour required:

Note Replace ** with suffix code to denote finish required:

WSS Stainless steel with white interior	WPN Pearl nickel with white interior	BPC Polished chrome with black interior
BSS Stainless steel with black interior	BPB Polished brass with black interior	WPC Polished chrome with white interior
WPW Painted white with white interior	WPB Polished brass with white interior	BBN Black nickel with black interior



GU6412EWSS

Electronic dimmers



- Dimensions: 88 x 88mm (300VA)
- Mounting box: Min SB251 (300VA)
- Fix screws: M3.5 x 25mm and 30mm
- IR remote unit requires remote control
- All dimmers can be installed on 2 way and multiway circuits
- For 2 way operating remote switch must be changed for retractive switch
- BS EN 60669-2-1

Part number	Description	Qty
GU6412E***	1 gang 300W/VA	1
GU6422E***	2 gang 2 x 200W/VA	1
GU6412R***	1 gang IR remote control 300W/VA	1
GU6000RC1	1 channel IR remote control	1

Note: Electronic dimmers not suitable for use with CFL and LED lamps



GU64121WSS

- Dimensions: 88 x 148mm (1000W/VA)
- Mounting box: SB472 (1000W)
- Fix screws: M3.5 x 25mm and 30mm
- 1000W dimmer is fitted on to a 2 gang plate
- All dimmers can be installed on 2 way and multiway circuits
- For 2 way operating remote switch must be changed for retractive switch
- BS EN 60669-2-1

Part number	Description	Qty
GU64121***	1 gang 1000W/VA Black or White inserts	1

For product information and specification see technical section

Mains and low voltage dimmer switches



- Dimensions: 88 x 88mm (1-2 gang), 88 x 148mm (3-4 gang)
- Mounting box:
 - SB161 (F) 1G 1W only
 - SB251 (F) 1-2 gang
 - SB352 (F) 3-4 gang
- Fix screws: M3.5 x 25mm and 30mm
- BS EN 60669-2-1

Part number	Description	Qty
Mains		
GU6411**	1 gang 1 way 400W*	1
GU6412**	1 gang 2 way 400W	1
GU6422**	2 gang 2 way 250W	1
GU6432**	3 gang 2 way 250W	1
GU6442**	4 gang 2 way 250W	1

Part number	Description	Qty
Low voltage		
GU6411LV**	1 gang 1 way 400VA*	1
GU6412LV**	1 gang 2 way 400VA	1
GU6422LV**	2 gang 2 way 250VA	1
GU6432LV**	3 gang 2 way 250VA	1
GU6442LV**	4 gang 2 way 250VA	1

Mains dimmer switches are not suitable on low voltage circuits. See technical section

*1 way dimmers can be used to replace standard wall switches and retrofit into 16mm mounting box



GU6422PB



GU6412LVSS

Note Replace *** with suffix code to denote finish/interior colour required:

Note Replace ** with suffix code to denote finish required:

WSS Stainless steel with white interior	WPN Pearl nickel with white interior	BPC Polished chrome with black interior
BSS Stainless steel with black interior	BPB Polished brass with black interior	WPC Polished chrome with white interior
WPW Painted white with white interior	WPB Polished brass with white interior	BBN Black nickel with black interior



GU1412KWPB

Key card switch

- Dimensions: 88 x 88mm
- Mounting box: SB471(F)
- Fix screws: M3.5 x 25mm and 30mm
- BS EN 60669-1
- Non reader type, accepts any card (not supplied)
- Will accept cards up to 85 x 53mm
- Requires L&N connection

Part number	Description	Qty
GU1412K***	32A SP keycard switch with 30 sec time delay	1



GU2411BBN

20AX & 32A DP switches

- Dimensions: 88 x 88mm
- Mounting box: SB351(F)
- Fix screws: M3.5 x 25mm and 30mm
- BS EN 60669-1

Part number	Description	Qty
GU2410***	20A DP switch	1
GU2411***	20A DP switch with neon	1
GU2413***	20A DP switch with flex outlet	1
GU2414***	20A DP switch with neon an flex outlet	1
GU2414WH***	20A DP switch with neon and flex outlet marked water heater	1
GU4431***	32A 1 gang DP switch with neon	1



GU5410WPC

13A fused connection units

- Dimensions: 88 x 88mm
- Mounting box:
 - Unswitched SB251 (F)
 - Switched SB351 (F)
- Fix screws: M3.5 x 25mm and 30mm
- BS 1363

Part number	Description	Qty
GU5400***	Unswitched	1
GU5403***	Unswitched with flex outlet	1
GU5410***	DP switched	1
GU5411***	DP switched with neon	1
GU5413***	DP switched with flex outlet	1
GU5414***	DP switched with neon and flex outlet	1



GU4421BBN

45A DP switches

- Dimensions: 148 x 88mm
- Mounting box: SB472 (F)
- Fix screws: M3.5 x 25mm and 30mm
- BS EN 60669-1

Part number	Description	Qty
GU4421***	45A 2 gang DP switch with neon (fits 2 gang box)	1



GU4401BPB

45A DP cooker controls

- Dimensions: 88 x 148mm
- Mounting box: SB472 (F)
- Fix screws: M3.5 x 25mm and 30mm
- BS 4177

Part number	Description	Qty
GU4401***	DP cooker control unit & 13A switched socket with neons	1

Note Replace *** with suffix code to denote finish/interior colour required:

WSS Stainless steel with white interior	WPN Pearl nickel with white interior	BPC Polished chrome with black interior
BSS Stainless steel with black interior	BPB Polished brass with black interior	WPC Polished chrome with white interior
WPW Painted white with white interior	WPB Polished brass with white interior	BBN Black nickel with black interior



GU7490WSS

Shaver sockets

- Dimensions: 148 x 88mm
- Mounting box: SB472 (F)
- Fix screws: M3.5 x 25mm and 30mm
- BS EN 61558-2-5

Part number	Description	Qty
GU7490***	115/230V dual voltage	1

Special unique design allows perfect fit to 47mm box



GU7461WPB

Telephone & data outlets

- Dimensions: 88 x 88mm
- Mounting box:
 - SB251 (F)
 - SB351 (F)
- Fix screws: M3.5 x 25mm and 30mm
- BS EN 41003
- Refer to euro modular range for further combinations

Part number	Description	Qty
GU7451***	Single RJ11 outlet	1
GU7461***	Single telephone master	1
GU7462***	Single telephone secondary	1
GU7471***	Single RJ45 outlet	1



GU7410WPN

TV outlets

- Dimensions: 88 x 88mm
- Mounting box: SB251 (F)
- Fix screws: M3.5 x 25mm and 30mm
- Products are direct connection and not suitable for common connection
- BS 3041 (where applicable)

Part number	Description	Qty
GU7410***	Single TV/FM socket	1
GU7420***	Twin TV/FM socket	1
GU7430***	Single SAT socket	1



GU8410SS

Blank plates

- Dimensions: 88 x 88mm (1 gang), 88 x 148mm (2 gang)
- Fix screws: M3.5 x 25mm and 30mm
- BS 5733

Part number	Description	Qty
GU8410**	1 gang	1
GU8420**	2 gang	1

Note Replace *** with suffix code to denote finish/interior colour required:

Note Replace ** with suffix code to denote finish required:

WSS Stainless steel with white interior	WPN Pearl nickel with white interior	BPC Polished chrome with black interior
BSS Stainless steel with black interior	BPB Polished brass with black interior	WPC Polished chrome with white interior
WPW Painted white with white interior	WPB Polished brass with white interior	BBN Black nickel with black interior



Ultimate screwless polycarbonate, transparent and textured

The Ultimate screwless range takes a sleek sophisticated design one step further with the polycarbonate plate accessories in piano black or gloss white finish which will add style and customisation to any interior.

Maintaining the superior engineering and sophisticated design, these accessories provide even greater harmony to the surrounding décor.

Features & benefits:

Polycarbonate

- > 3.5mm slim front plate profile
- > Complementary to modern styling
- > All plates switches are 10AX rated for maximum fluorescent rating
- > Dual terminal colour marking for easier cable insertion
- > Hardwearing and durable polycarbonate

Transparent

- > Minimal back projection for both new and retrofits (switches 16mm, sockets 25mm)
- > Unique integral locking facility on isolator for added safety
- > Switches are fully rated at 10AX for fluorescent and inductive loads

Textured

- > 1.5mm ultra slim front plate profile
- > All plates switches are 10AX rated for maximum fluorescent rating
- > Dual terminal colour marking for easier cable insertion
- > Unique textured effect matches today's soft feel furnishings



GU3410DBBK

Socket outlets

- Dimensions: 88 x 88mm (1 gang), 88 x 148mm (2 gang)
- Mounting box:
 - SB251 (F) 1 gang
 - SB351 (F) 1 gang
 - SB252 (F) 2 gang
 - SB352 (F) 2 gang
- Fix screws: M3.5 x 25mm and 30mm
- BS 1363
- BS 947
- BS 546 (GU3480***)

Part number	Description	Qty
GU3410D***	1 gang DP switched	1
GU3420D***	2 gang DP switched	1
GU3480***	5A round pin unswitched	1
GU3431WWH	2 gang switched with outboard rockers & clean earth - Gloss White	1



GU1413WWH

10AX plate switches

- Dimensions: 88 x 88mm (1-2 gang)
- Mounting box: SB161 (F) 1 - 2 gang
- Fix screws: M3.5 x 25mm and 30mm
- BS EN 60669-1
- BS EN 60947-3 (GU1413***)

Part number	Description	Qty
GU1412***	1 gang 2 way SP	1
GU1422***	2 gang 2 way SP	1
GU1413***	3 pole isolator	1



GU6412BK

Mains dimmer switches

- Dimensions: 88 x 88mm (1 gang)
- Mounting box: SB251 (F) 1 - 2 gang
- Fix screws: M3.5 x 25mm and 30mm
- BS EN 60669-2-1

Part number	Description	Qty
GU6412**	1 gang 2 way 400W	1
GU6422**	2 gang 2 way 250W	1



GU5411WWH

20AX DP switches & 13A fused connection unit

- Dimensions: 88 x 88mm (1 gang)
- Mounting box: SB251 (F)
- Fix screws: M3.5 x 25mm and 30mm
- BS EN 60669-1
- BS 1363

Part number	Description	Qty
GU2411***	20AX DP switch with neon	1
GU5411***	13A switched with neon fused connection unit	1

Note Replace *** with suffix code to denote finish/interior colour required:

Note Replace ** with suffix code to denote finish colour required:

BBK Piano black

WWH Gloss white



GU4401BBK

45A DP cooker controls

- Dimensions: 88 x 148mm
- Mounting box: SB472 (F)
- Fix screws: M3.5 x 25mm and 30mm
- BS 4177

Part number	Description	Qty
GU4401***	DP cooker control unit with neon	1



GU7490WWH

Shaver sockets

- Dimensions: 148 x 88mm
- Mounting box: SB472 (F)
- Fix screws: M3.5 x 25mm and 30mm
- BS EN 61558-2-5

Part number	Description	Qty
GU7490***	115/230V dual voltage	1



GU7410BBK

Communication outlets

- Dimensions: 88 x 88mm (1 gang)
- Mounting box: SB251 (F)
- Fix screws: M3.5 x 25mm and 30mm
- BS 3041 (where applicable)







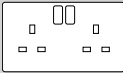

Part number	Description	Qty
GU7461***	Master telephone socket	1
GU7462***	Secondary telephone socket	1
GU7410***	Single TV/FM co-axial	1

Note Replace *** with suffix code to denote finish/interior colour required:





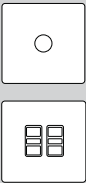



BBK Piano black

WWH Gloss white





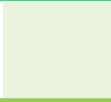

Ultimate screwless flat plate selection table

		Finishes					
		Piano black	Gloss white	Textured black	Transparent	Polished brass white interior	
13A socket outlets		1G 13A unswitched				GU3450WPB	
		2G 13A unswitched				GU3460WPB	
		1G 13A switched			GU3410BRB	GU3410CLR	GU3410WPB
		1G 13A DP switched	GU3410DBBK	GU3410DWWH			GU3410DWPB
		1G 13A switched + neon					GU3411WPB
		2G 13A switched			GU3420BRB	GU3420CLR	GU3420WPB
		2G 13A DP switched	GU3420DBBK	GU3420DWWH			GU3420DWPB
		2G 13A O/B DP switched + C/E					
		2G 13A O/B DP switched + C/E + N/S + Neon					
		2G 13A switched + neon					GU3421WPB
		Media plate 4 socket 8 euromodule					
Round pin socket outlets		2A unswitched				GU3470WPB	
		5A unswitched	GU3480BBK	GU3480WWH		GU3480WPB	
		15A switched				GU3490WPB	
10AX plate switches		1G 2W switch	GU1412BBK	GU1412WWH	GU1412BRB	GU1412CLR	GU1412WPB
		2G 2W switch	GU1422BBK	GU1422WWH	GU1422BRB	GU1422CLR	GU1422WPB
		3G 2W switch			GU1432BRB	GU1432CLR	GU1432WPB
		4G 2W switch					GU1442WPB
		6G 2W switch					GU1462WPB
		1G TP isolator	GU1413BBK	GU1413WWH			GU1413WPB
		1G intermediate switch					GU1414WPB
		1G 2W retractive switch					GU1412RWPB
150W PIR plate switch		1G 1W switch with override					
		1G 1W switch					
32A Keycard switch		32A Keycard switch				GU1412KWPB	
10AX toggle switches		1G 2W 10AX			GU1412CLR	GU1412TPB	
		2G 2W 10AX			GU1422CLR	GU1422TPB	
		3G 2W 10AX					GU1432TPB
		4G 2W 10AX					GU1442TPB
Dimmer switches		1G 1W 400W mains				GU6411PB	
		1G 2W 400W mains	GU6412BK	GU6412WH	GU6412RB	GU6412CLR	GU6412PB
		2G 2W 250W mains	GU6422BK	GU6422WH	GU6422RB	GU6422CLR	GU6422PB
		3G 2W 250W mains					GU6432PB
		4G 2W 250W mains					GU6442PB
		1G 1W 400VA low voltage					GU6411LVPB
		1G 2W 400VA low voltage					GU6412LVPB
		2G 2W 250VA low voltage					GU6422LVPB
		3G 2W 250VA low voltage					GU6432LVPB
		4G 2W 250VA low voltage					GU6442LVPB
		1G slimline 300VA electronic					GU6412EWPB
		1G slimline IR remote control 300VA electronic					GU6412RWPB
		2G 2 x 200W/VA electronic					GU6422EWPB
		1G 1000W/VA electronic					GU64121WPB
		1 channel remote control					GU6000RC1
20A DP & 32A plate switches		20A DP switch			GU2410BRB	GU2410CLR	GU2410WPB
		20A DP switch + flex outlet					GU2413WPB
		20A DP switch + neon	GU2411BBK	GU2411WWH			GU2411WPB
		20A DP switch + neon + flex outlet					GU2414WPB
		20A DP switch + neon + flex outlet					GU2414WHWPB
		32A 1G DP switch + neon					GU4431WPB

*Dependent upon wiring configuration, to aid installation 35mm flush steel boxes are recommended.

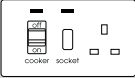
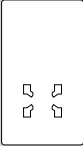
Polished brass black interior	Polished chrome white interior	Polished chrome black interior	Pearl nickel white interior	Stainless steel white interior	Stainless steel black interior	White metal white interior	Black nickel black interior	Mounting box depth
								
GU3450BPB	GU3450WPC	GU3450BPC	GU3450WPN	GU3450WSS	GU3450BSS	GU3450WPW	GU3450BBN	*25/35mm
GU3460BPB	GU3460WPC	GU3460BPC	GU3460WPN	GU3460WSS	GU3460BSS	GU3460WPW	GU3460BBN	*25/35mm
GU3410BPB	GU3410WPC	GU3410BPC	GU3410WPN	GU3410WSS	GU3410BSS	GU3410WPW	GU3410BBN	*25/35mm
GU3410DBPB	GU3410DWPC	GU3410DBPC	GU3410DWPN	GU3410DWSS	GU3410DBSS	GU3410DWPW	GU3410DBBN	*25/35mm
GU3411BPB	GU3411WPC	GU3411BPC	GU3411WPN	GU3411WSS	GU3411BSS	GU3411WPW	GU3411BBN	*25/35mm
GU3420BPB	GU3420WPC	GU3420BPC	GU3420WPN	GU3420WSS	GU3420BSS	GU3420WPW	GU3420BBN	*25/35mm
GU3420DBPB	GU3420DWPC	GU3420DBPC	GU3420DWPN	GU3420DWSS	GU3420DBSS	GU3420DWPW	GU3420DBBN	*25/35mm
	GU3431WPC	GU3431BPC		GU3431WSS	GU3431BSS	GU3431WPW		35mm
	GU3434WPC			GU3434WSS	GU3434BSS			35mm
GU3421BPB	GU3421WPC	GU3421BPC	GU3421WPN	GU3421WSS	GU3421BSS	GU3421WPW	GU3421BBN	*25/35mm
	GU3420DWPCMP			GU3420DWSSMP		GU3420DWPWMP		40mm
GU3470BPB	GU3470WPC	GU3470BPC	GU3470WPN	GU3470WSS	GU3470BSS	GU3470WPW	GU3470BBN	25mm
GU3480BPB	GU3480WPC	GU3480BPC	GU3480WPN	GU3480WSS	GU3480BSS	GU3480WPW	GU3480BBN	25mm
GU3490BPB	GU3490WPC	GU3490BPC	GU3490WPN	GU3490WSS	GU3490BSS	GU3490WPW	GU3490BBN	25mm
GU1412BPB	GU1412WPC	GU1412BPC	GU1412WPN	GU1412WSS	GU1412BSS	GU1412WPW	GU1412BBN	16mm
GU1422BPB	GU1422WPC	GU1422BPC	GU1422WPN	GU1422WSS	GU1422BSS	GU1422WPW	GU1422BBN	16mm
GU1432BPB	GU1432WPC	GU1432BPC	GU1432WPN	GU1432WSS	GU1432BSS	GU1432WPW	GU1432BBN	25mm
GU1442BPB	GU1442WPC	GU1442BPC	GU1442WPN	GU1442WSS	GU1442BSS	GU1442WPW	GU1442BBN	25mm
GU1462BPB	GU1462WPC	GU1462BPC	GU1462WPN	GU1462WSS	GU1462BSS	GU1462WPW	GU1462BBN	25mm
GU1413BPB	GU1413WPC	GU1413BPC	GU1413WPN	GU1413WSS	GU1413BSS	GU1413WPW	GU1413BBN	25mm
GU1414BPB	GU1414WPC	GU1414BPC	GU1414WPN	GU1414WSS	GU1414BSS	GU1414WPW	GU1414BBN	25mm
GU1412RBPB	GU1412RWPC	GU1412RBPC	GU1412RWPN	GU1412RWSS	GU1412RBSS	GU1412RWPW	GU1412RBBN	25mm
					GU1411BSS			
					GU1411BSS			
GU1412KBPB	GU1412KWPC	GU1412KBPC	GU1412KWPN	GU1412KWSS	GU1412KBSS	GU1412KWPW	GU1412KBBN	47mm
GU1412TPB	GU1412TPC	GU1412TPC	GU1412TPN	GU1412TSS	GU1412TSS	GU1412TPW	GU1412TBN	16mm
GU1422TPB	GU1422TPC	GU1422TPC	GU1422TPN	GU1422TSS	GU1422TSS	GU1422TPW	GU1422TBN	16mm
GU1432TPB	GU1432TPC	GU1432TPC	GU1432TPN	GU1432TSS	GU1432TSS	GU1432TPW	GU1432TBN	25mm
GU1442TPB	GU1442TPC	GU1442TPC	GU1442TPN	GU1442TSS	GU1442TSS	GU1442TPW	GU1442TBN	25mm
GU6411PB	GU6411PC	GU6411PC	GU6411PN	GU6411SS	GU6411SS	GU6411PW	GU6411BN	16mm
GU6412PB	GU6412PC	GU6412PC	GU6412PN	GU6412SS	GU6412SS	GU6412PW	GU6412BN	25mm
GU6422PB	GU6422PC	GU6422PC	GU6422PN	GU6422SS	GU6422SS	GU6422PW	GU6422BN	25mm
GU6432PB	GU6432PC	GU6432PC	GU6432PN	GU6432SS	GU6432SS	GU6432PW	GU6432BN	35mm
GU6442PB	GU6442PC	GU6442PC	GU6442PN	GU6442SS	GU6442SS	GU6442PW	GU6442BN	35mm
GU6411LVPB	GU6411LVPC	GU6411LVPC	GU6411LVPN	GU6411LVSS	GU6411LVSS	GU6411LVPW	GU6411LVBN	16mm
GU6412LVPB	GU6412LVPC	GU6412LVPC	GU6412LVPN	GU6412LVSS	GU6412LVSS	GU6412LVPW	GU6412LVBN	25mm
GU6422LVPB	GU6422LVPC	GU6422LVPC	GU6422LVPN	GU6422LVSS	GU6422LVSS	GU6422LVPW	GU6422LVBN	25mm
GU6432LVPB	GU6432LVPC	GU6432LVPC	GU6432LVPN	GU6432LVSS	GU6432LVSS	GU6432LVPW	GU6432LVBN	35mm
GU6442LVPB	GU6442LVPC	GU6442LVPC	GU6442LVPN	GU6442LVSS	GU6442LVSS	GU6442LVPW	GU6442LVBN	35mm
GU6412EBPB	GU6412EWPC	GU6412EBPC	GU6412EWPN	GU6412EWSS	GU6412EBSS	GU6412EWPW	GU6412EBBN	25mm
GU6412RBPB	GU6412RWPC	GU6412RBPC	GU6412RWPN	GU6412RWSS	GU6412RBSS	GU6412RWPW	GU6412RBBN	25mm
GU6422EBPB	GU6422EWPC	GU6422EBPC	GU6422EWPN	GU6422EWSS	GU6422EBSS	GU6422EWPW	GU6422EBBN	25mm
GU64121BPB	GU64121WPC	GU64121BPC	GU64121WPN	GU64121WSS	GU64121BSS	GU64121WPW	GU64121BBN	47mm
GU6000RC1	GU6000RC1	GU6000RC1	GU6000RC1	GU6000RC1	GU6000RC1	GU6000RC1	GU6000RC1	N/A
GU2410BPB	GU2410WPC	GU2410BPC	GU2410WPN	GU2410WSS	GU2410BSS	GU2410WPW	GU2410BBN	25mm
GU2413BPB	GU2413WPC	GU2413BPC	GU2413WPN	GU2413WSS	GU2413BSS	GU2413WPW	GU2413BBN	35mm
GU2411BPB	GU2411WPC	GU2411BPC	GU2411WPN	GU2411WSS	GU2411BSS	GU2411WPW	GU2411BBN	25mm
GU2414BPB	GU2414WPC	GU2414BPC	GU2414WPN	GU2414WSS	GU2414BSS	GU2414WPW	GU2414BBN	35mm
GU2414WHBPB	GU2414WHWPC	GU2414WHBPC	GU2414WHWPN	GU2414WHWSS	GU2414WHBSS	GU2414WHWPW	GU2414WHBBN	35mm
GU4431BPB	GU4431WPC	GU4431BPC	GU4431WPN	GU4431WSS	GU4431BSS	GU4431WPW	GU4431BBZ	47mm

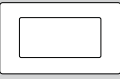





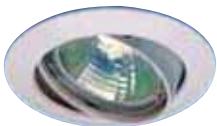

Due to large plate foot print products may not be compatible with flush dual mounting boxes

		Finishes					
		Piano black	Gloss white	Textured black	Transparent	Polished brass white interior	
13A Fused connection units		13A unswitched				GU5400WPB	
		13A unswitched + flex outlet				GU5403WPB	
		13A switched		GU5410BRB	GU5410CLR	GU5410WPB	
		13A switched + flex outlet				GU5413WPB	
		13A switched + neon	GU5411BBK	GU5411WWH		GU5411WPB	
		13A switched + neon + flex outlet				GU5414WPB	
45A control switches		45A 2G DP switch + neon				GU4421WPB	
45A cooker control units		45A DP cooker control unit + 13A switched socket + neon	GU4401BBK	GU4401WWH		GU4401WPB	
Shaver socket outlet		115/230V dual voltage	GU7490BBK	GU7490WWH		GU7490WPB	
Telephone socket outlets		RJ11 telephone outlet				GU7451WPB	
		Master telephone outlet	GU7461BBK	GU7461WWH		GU7461WPB	
		Secondary telephone outlet	GU7462BBK	GU7462WWH	GU7462BRB	GU7462CLR	GU7462WPB
		Single RJ45 outlet					GU7471WPB
TV socket outlets		Single TV/FM coaxial socket	GU7410BBK	GU7410WWH	GU7410BRB	GU7410CLR	GU7410WPB
		Twin TV/FM coaxial socket					GU7420WPB
		Single satellite socket					GU7430WPB
Euro modular plates		1G euro plate				GU8450PB	
		2G euro plate				GU8460PB	
		4G euro plate				GU8480PB	
Blank plates		1G blank plate				GU8410PB	
		2G blank plate				GU8420PB	

*Dependent upon wiring configuration, to aid installation 35mm flush steel boxes are recommended.



For complementary downlighters that match Ultimate screwless flat plate please see lighting section

Polished brass black interior	Polished chrome white interior	Polished chrome black interior	Pearl nickel white interior	Stainless steel white interior	Stainless steel black interior	White metal white interior	Black nickel black interior	Mounting box depth
								
GU5400BPB	GU5400WPC	GU5400BPC	GU5400WPN	GU5400WSS	GU5400BSS	GU5400WPW	GU5400BBN	25mm
GU5403BPB	GU5403WPC	GU5403BPC	GU5403WPN	GU5403WSS	GU5403BSS	GU5403WPW	GU5403BBN	35mm
GU5410BPB	GU5410WPC	GU5410BPC	GU5410WPN	GU5410WSS	GU5410BSS	GU5410WPW	GU5410BBN	35mm
GU5413BPB	GU5413WPC	GU5413BPC	GU5413WPN	GU5413WSS	GU5413BSS	GU5413WPW	GU5413BBN	35mm
GU5411BPB	GU5411WPC	GU5411BPC	GU5411WPN	GU5411WSS	GU5411BSS	GU5411WPW	GU5411BBN	35mm
GU5414BPB	GU5414WPC	GU5414BPC	GU5414WPN	GU5414WSS	GU5414BSS	GU5414WPW	GU5414BBN	35mm
GU4421BPB	GU4421WPC	GU4421BPC	GU4421WPN	GU4421WSS	GU4421BSS	GU4421WPW	GU4421BBN	47mm
GU4401BPB	GU4401WPC	GU4401BPC	GU4401WPN	GU4401WSS	GU4401BSS	GU4401WPW	GU4401BBN	47mm
GU7490BPB	GU7490WPC	GU7490BPC	GU7490WPN	GU7490WSS	GU7490BSS	GU7490WPW	GU7490BBN	47mm
GU7451BPB	GU7451WPC	GU7451BPC	GU7451WPN	GU7451WSS	GU7451BSS	GU7451WPW	GU7451BBN	25mm
GU7461BPB	GU7461WPC	GU7461BPC	GU7461WPN	GU7461WSS	GU7461BSS	GU7461WPW	GU7461BBN	25mm
GU7462BPB	GU7462WPC	GU7462BPC	GU7462WPN	GU7462WSS	GU7462BSS	GU7462WPW	GU7462BBN	25mm
GU7471BPB	GU7471WPC	GU7471BPC	GU7471WPN	GU7471WSS	GU7471BSS	GU7471WPW	GU7471BBN	35mm
GU7410BPB	GU7410WPC	GU7410BPC	GU7410WPN	GU7410WSS	GU7410BSS	GU7410WPW	GU7410BBN	25mm
GU7420BPB	GU7420WPC	GU7420BPC	GU7420WPN	GU7420WSS	GU7420BSS	GU7420WPW	GU7420BBN	35mm
GU7430BPB	GU7430WPC	GU7430BPC	GU7430WPN	GU7430WSS	GU7430BSS	GU7430WPW	GU7430BBN	25mm
GU8450PB	GU8450PC	GU8450PC	GU8450PN	GU8450SS	GU8450SS	GU8450PW	GU8450BN	**
GU8460PB	GU8460PC	GU8460PC	GU8460PN	GU8460SS	GU8460SS	GU8460PW	GU8460BN	**
GU8480PB	GU8480PC	GU8480PC	GU8480PN	GU8480SS	GU8480SS	GU8480PW	GU8480BN	**
GU8410PB	GU8410PC	GU8410PC	GU8410PN	GU8410SS	GU8410SS	GU8410PW	GU8410BN	N/A
GU8420PB	GU8420PC	GU8420PC	GU8420PN	GU8420SS	GU8420SS	GU8420PW	GU8420BN	N/A

Due to large plate foot print products may not be compatible with flush dual mounting boxes



Ultimate flat plate

The ultra-slim Ultimate flat plate range and grid system is all about superior engineering and urbane style. This beautifully crafted, easy to install range adds that special finishing touch to any interior.

Available in a choice of six high quality plate finishes with black or white interior options, coordinating these accessories has never been easier.

Features & benefits:

Consumer

- > Comprehensive range extends to toggle and dimmer switches plus data communication and all control applications
- > Colour matched flat headed screws and eyelets add that finishing touch
- > Large plate footprint avoids the need for additional decorating on retrofits
- > Smooth tactile switch action
- > Slimline, compact neons for a subtle effect
- > Curved, matching metal capped rockers that are aesthetically pleasing and easy to operate with a choice of white or black interior
- > Fully matched grid system

Installer

- > Minimal back projection to allow installation using standard flush mounting boxes for both new and retrofits, i.e. shaver sockets also allow installation using a standard 47mm mounting box
- > Full 10AX fluorescent rating on all plate switches
- > Metal capped fuse carriers provide more visible metal on the plate
- > Accessories supplied with both long and short screws for installation flexibility
- > Large in-line angled colour coded terminals to aid cable insertion and selection
- > Foam gasket to assist mounting on uneven walls or provide a barrier to moisture
- > Double pole options on 1-gang and 2-gang switched sockets (Twin earth terminals on 2-gang sockets)



GU3250WSS

13A unswitched sockets

- Dimensions: 88 x 88mm (1 gang), 88 x 148mm (2 gang)
- Mounting box:
 - SB251 (F) 1 gang
 - SB351 (F) 1 gang
 - SB252 (F) 2 gang
 - SB352 (F) 2 gang
- Fix screws: M3.5 x 25mm and 30mm
- BS 1363

Part number	Description	Qty
GU3250***	1 gang	1
GU3260***	2 gang	1



GU3220WPC

13A switched sockets

- Dimensions: 88 x 88mm (1 gang), 88 x 148mm (2 gang)
- Mounting box:
 - SB251 (F) 1 gang
 - SB351 (F) 1 gang
 - SB252 (F) 2 gang
 - SB352 (F) 2 gang
- Fix screws: M3.5 x 25mm and 30mm
- BS 1363

Part number	Description	Qty
GU3210***	1 gang switched	1
GU3211***	1 gang switched with neon	1
GU3220***	2 gang switched	1
GU3221***	2 gang switched with neons	1
GU3210D***	1 gang DP switched	1
GU3220D***	2 gang DP switched	1



GU3234WSS

13A DP outboard rocker switched socket outlet

- Dimensions: 88 x 88mm
- Mounting box:
 - SB252 (F)
 - SB352 (F)
- Fixed screws: M3.5 x 25mm and 30mm
- BS 1363

Part number	Description	Qty
GU3231***	2 gang switched with clean earth	1
GU3234***	2 gang switched with clean earth non standard and neons	1



GU3280WPB

Round pin socket outlets

- Dimensions: 88 x 88mm
- Mounting box: SB251 (F)
- Fixed screws: M3.5 x 25mm and 30mm
- BS 546

Part number	Description	Qty
GU3270***	2A unswitched	1
GU3280***	5A unswitched	1
GU3290***	15A switched	1

Note: All 2 gang sockets include twin earth terminals as standard, enabling high integrity earthing. To aid flush installation 35mm steel boxes are recommended.

Note Replace *** with suffix code to denote finish/interior colour required:

WSS Stainless steel with white interior	WPN Pearl nickel with white interior	BPC Polished chrome with black interior
BSS Stainless steel with black interior	BPB Polished brass with black interior	WPC Polished chrome with white interior
WPW Painted white with white interior	WPB Polished brass with white interior	BBN Black nickel with black interior



GU3251WSS

13A floor sockets

- Dimensions: 88 x 88mm (1 gang), 88 x 148mm (2 gang)
- Mounting box:
 - SB251 (F) 1 gang
 - SB351 (F) 1 gang
 - SB252 (F) 2 gang
 - SB352 (F) 2 gang
- Fixed screws: M3.5 x 25mm and 30mm
- BS 1363

Part number	Description	Qty
GU3251W**	1 gang unswitched	1
GU3252W**	2 gang unswitched	1

All 2 gang sockets include twin earth terminals as standard, enabling compliance with regulation 607 (BS 7671) – high integrity earthing. To aid flush installation 35mm steel boxes are recommended. Floor socket interiors are manufactured from high impact thermoplastic for strength.



GU1212BSS

10A & 10AX plate switches

- Dimensions: 88 x 88mm (1-3 gang), 88 x 148mm (4-6 gang)
- Mounting box: See selection table
- Fix screws: M3.5 x 25mm and 30mm
- BS EN 60669-1
- BS EN 60947-3 (GU1213***)

Part number	Description	Qty
GU1212***	1 gang 2 way SP	1
GU1212R***	10A 1 gang 2 way retractive	1
GU1222***	2 gang 2 way SP	1
GU1232***	3 gang 2 way SP	1
GU1242***	4 gang 2 way SP	1
GU1262***	6 gang 2 way SP	1
GU1213***	3 pole isolator	1
GU1214***	1 gang intermediate	1



GU1212TBN

10AX toggle switches

- Dimensions: 88 x 88mm (1-3 gang), 88 x 148mm (4 gang)
- Mounting box:
 - SB161 (F) 1-2 gang
 - SB251 (F) 3 gang
 - SB252 (F) 4 gang
- Fix screws: M3.5 x 25mm and 30mm
- BS EN 60669-1

Part number	Description	Qty
GU1212T**	1 gang 2 way	1
GU1222T**	2 gang 2 way	1
GU1232T**	3 gang 2 way	1
GU1242T**	4 gang 2 way	1



GU6222EWPB

Electronic dimmers



- Dimensions: 88 x 88mm
- Mounting box: Min SB251
- Fix screws: M3.5 x 25mm and 30mm
- BS EN 60669-2-1
- IR remote unit requires remote control (GU6000RC1)
- All dimmers can be installed on 2 way and multiway circuits
- For 2 way operating remote switch must be changed for retractive switch
- For lamp suitability check the technical section

Part number	Description	Qty
GU6212E***	1 gang 300W/VA	1
GU6222E***	2 gang 2 x 200W/VA	1
GU6212R***	1 gang slimline IR remote control 300VA	1
GU6000RC1	1 channel IR remote control	1

Note: Electronic dimmers are not suitable for use with CFL and LED lamps.



GU6000RC1



Mains and low voltage dimmer switches

- Dimensions: 88 x 88mm (1-2 gang), 88 x 148mm (3-4 gang)
- Mounting box:
 - SB251 (F) 1-2 gang
 - SB352 (F) 3-4 gang
- Fix screws: M3.5 x 25mm and 30mm
- BS EN 60669-2-1
- Supplied with 15mm & 30mm screws



GU6222PB



GU6242LVPC

Part number	Description	Qty
Mains		
GU6211**	1 gang 1 way 400W*	1
GU6212**	1 gang 2 way 400W	1
GU6222**	2 gang 2 way 250W	1
GU6232**	3 gang 2 way 250W	1
GU6242**	4 gang 2 way 250W	1

Low voltage		
GU6211LV**	1 gang 1 way 400VA*	1
GU6212LV**	1 gang 2 way 400VA	1
GU6222LV**	2 gang 2 way 250VA	1
GU6232LV**	3 gang 2 way 250VA	1
GU6242LV**	4 gang 2 way 250 VA	1

*1 way dimmers can be used to replace standard wall switches and retrofit into 16mm mounting box
 Mains dimmer switches are not suitable on low voltage circuits. See technical section.

20A & 32A DP switches

- Dimensions: 88 x 88mm
- Mounting box: SB351 (F)
- Fix screws: M3.5 x 25mm and 30mm
- BS EN 60669-1



GU2211WPB

Part number	Description	Qty
GU2210***	20A DP switch	1
GU2211***	20A DP switch with neon	1
GU2213***	20A DP switch with flex outlet	1
GU2214***	20A DP switch with neon and flex outlet	1
GU2214WH***	20A DP switch with neon and flex outlet marked water heater	1
GU4231***	32A 1 gang DP switch with neon	1

Note Replace *** with suffix code to denote finish/interior colour required:

Note Replace ** with suffix code to denote finish colour required:

WSS Stainless steel with white interior	WPN Pearl nickel with white interior	BPC Polished chrome with black interior
BSS Stainless steel with black interior	BPB Polished brass with black interior	WPC Polished chrome with white interior
WPW Painted white with white interior	WPB Polished brass with white interior	BBN Black nickel with black interior



GU5214WPN

13A fused connection units

- Dimensions: 88 x 88mm
- Mounting box:
 - Unswitched SB251 (F)
 - Switched SB351 (F)
- Fix screws: M3.5 x 25mm and 30mm
- BS 1363

Part number	Description	Qty
GU5200***	Unswitched	1
GU5203***	Unswitched with flex outlet	1
GU5210***	DP switched	1
GU5211***	DP switched with neon	1
GU5213***	DP switched with flex outlet	1
GU5214***	DP switched with neon and flex outlet	1



GU4221BPB

45A DP switches

- Dimensions: 148 x 88mm
- Mounting box: SB472 (F)
- Fix screws: M3.5 x 25mm and 30mm
- BS EN 60669-1

Part number	Description	Qty
GU4221***	45A 2 gang DP switch with neon	1



GU4201WPN

45A DP cooker controls

- Dimensions: 88 x 148mm
- Mounting box: SB472 (F)
- Fix screws: M3.5 x 25mm and 30mm
- BS 4177

Part number	Description	Qty
GU4201***	DP cooker control unit and 13A switched socket with neons	1



GU7290WPN

Shaver sockets

- Dimensions: 148 x 88mm
- Mounting box: SB472 (F)
- Fix screws: M3.5 x 25mm and 30mm
- Unique 47mm flush fitting
- BS EN 61558-2-5

Part number	Description	Qty
GU7290***	115/230V dual voltage	1

Note Replace *** with suffix code to denote finish/interior colour required:

WSS Stainless steel with white interior	WPN Pearl nickel with white interior	BPC Polished chrome with black interior
BSS Stainless steel with black interior	BPB Polished brass with black interior	WPC Polished chrome with white interior
WPW Painted white with white interior	WPB Polished brass with white interior	BBN Black nickel with black interior



GU7262BBN

Telephone & data outlets

- Dimensions: 88 x 88mm
- Mounting box:
 - SB251 (F)
 - SB351 (F)
- Fix screws: M3.5 x 25mm and 30mm
- BS EN 41003
- Refer to euro modular range for further combinations

Part number	Description	Qty
GU7251***	Single RJ11 outlet	1
GU7261***	Single telephone master	1
GU7262***	Single telephone secondary	1
GU7271***	Single RJ45 outlet	1



GU7210WPN

TV outlets

- Dimensions: 88 x 88mm
- Mounting box: SB351 (F) 1-2 gang
- Fix screws: M3.5 x 25mm and 30mm
- Products are direct connection and are not suitable for common connection.
- BS 3041 (where applicable)

Part number	Description	Qty
GU7210***	Single TV/FM socket	1
GU7220***	Twin TV/FM socket	1
GU7230***	Single SAT socket	1



GU8210SS

Blank plates & replacement screws

- Dimensions: 88 x 88mm (1 gang), 88 x 148mm (2 gang)
- Fix screws: M3.5 x 25mm and 30mm
- BS 5733







Part number	Description	Qty
GU8210**	1 gang	1
GU8220**	2 gang	1
USCREW50**	Ultimate screw - M3.5 x 50mm	100

Note Replace *** with suffix code to denote finish/interior colour required:





WSS Stainless steel with white interior	WPN Pearl nickel with white interior	BPC Polished chrome with black interior
BSS Stainless steel with black interior	BPB Polished brass with black interior	WPC Polished chrome with white interior
WPW Painted white with white interior	WPB Polished brass with white interior	BBN Black nickel with black interior

		Finishes				
		Polished brass white interior	Polished brass black interior			
13A socket outlets		1G 13A unswitched	GU3250WPB	GU3250BPB		
		2G 13A unswitched	GU3260WPB	GU3260BPB		
		1G 13A switched	GU3210WPB	GU3210BPB		
		2G 13A switched	GU3220WPB	GU3220BPB		
		1G 13A switched + neon	GU3211WPB	GU3211BPB		
		2G 13A switched + neon	GU3221WPB	GU3221BPB		
		1G 13A DP switched	GU3210DWPB	GU3210DBPB		
		2G 13A DP switched	GU3220DWPB	GU3220DBPB		
		2G 13A O/B DP switched + C/E				
		2G 13A O/B DP switched + C/E + N/S + Neon				
		1G 13A unswitched floor socket	GU3251WPB			
		2G 13A unswitched floor socket	GU3252WPB			
		Round pin socket outlets		2A unswitched	GU3270WPB	GU3270BPB
				5A unswitched	GU3280WPB	GU3280BPB
15A switched	GU3290WPB			GU3290BPB		
10A & 10AX plate switches				10AX 1G 2W switch	GU1212WPB	GU1212BPB
		10AX 2G 2W switch	GU1222WPB	GU1222BPB		
		10AX 3G 2W switch	GU1232WPB	GU1232BPB		
		10AX 4G 2W switch	GU1242WPB	GU1242BPB		
		10AX 6G 2W switch	GU1262WPB	GU1262BPB		
		10AX 1G TP isolator	GU1213WPB	GU1213BPB		
		10AX 1G intermediate switch	GU1214WPB	GU1214BPB		
		10A 1G 2W retractive switch	GU1212RWPB	GU1212RBPB		
		10AX toggle switches		1G 2W 10AX	GU1212TPB	GU1212TPB
				2G 2W 10AX	GU1222TPB	GU1222TPB
3G 2W 10AX	GU1232TPB			GU1232TPB		
4G 2W 10AX	GU1242TPB			GU1242TPB		
Dimmer switches				1G 1W 400W mains	GU6211PB	GU6211PB
		1G 2W 400W mains	GU6212PB	GU6212PB		
		2G 2W 250W mains	GU6222PB	GU6222PB		
		3G 2W 250W mains	GU6232PB	GU6232PB		
		4G 2W 250W mains	GU6242PB	GU6242PB		
		1G 1W 400VA low voltage	GU6211LVPB	GU6211LVPB		
		1G 2W 400VA low voltage	GU6212LVPB	GU6212LVPB		
		2G 2W 250VA low voltage	GU6222LVPB	GU6222LVPB		
		3G 2W 250VA low voltage	GU6232LVPB	GU6232LVPB		
		4G 2W 250VA low voltage	GU6242LVPB	GU6242LVPB		
		1G slimline 300VA electronic	GU6212EWPB	GU6212EBPB		
		1G slimline IR remote control 300VA electronic	GU6212RWPB	GU6212RBPB		
		2G 2 x 200W/VA electronic	GU6222EWPB	GU6222EBPB		
		1 channel remote control	GU6000RC1	GU6000RC1		
20A DP plate switches		20A DP switch	GU2210WPB	GU2210BPB		
		20A DP switch + flex outlet	GU2213WPB	GU2213BPB		
		20A DP switch + neon	GU2211WPB	GU2211BPB		
		20A DP switch + neon + flex outlet	GU2214WPB	GU2214BPB		
		20A DP switch + neon + flex outlet marked water heater	GU2214WHWPB	GU2214WHBPB		
		32A 1G DP switch + neon	GU4231WPB	GU4231BPB		
		Fused connection units		13A unswitched	GU5200WPB	GU5200BPB
				13A unswitched + flex outlet	GU5203WPB	GU5203BPB
13A switched	GU5210WPB			GU5210BPB		
13A switched + flex outlet	GU5213WPB			GU5213BPB		
13A switched + neon	GU5211WPB			GU5211BPB		
13A switched + neon + flex outlet	GU5214WPB			GU5214BPB		

*Dependent upon wiring configuration, to aid installation 35mm flush steel boxes are recommended.

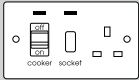
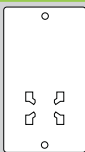
Polished chrome white interior	Polished chrome black interior	Pearl nickel white interior	Stainless steel white interior	Stainless steel black interior	White metal white interior	Black nickel black interior	Mounting box depth
							
GU3250WPC	GU3250BPC	GU3250WPN	GU3250WSS	GU3250BSS	GU3250WPW	GU3250BBN	*25/35mm
GU3260WPC	GU3260BPC	GU3260WPN	GU3260WSS	GU3260BSS	GU3260WPW	GU3260BBN	*25/35mm
GU3210WPC	GU3210BPC	GU3210WPN	GU3210WSS	GU3210BSS	GU3210WPW	GU3210BBN	*25/35mm
GU3220WPC	GU3220BPC	GU3220WPN	GU3220WSS	GU3220BSS	GU3220WPW	GU3220BBN	*25/35mm
GU3211WPC	GU3211BPC	GU3211WPN	GU3211WSS	GU3211BSS	GU3211WPW	GU3211BBN	*25/35mm
GU3221WPC	GU3221BPC	GU3221WPN	GU3221WSS	GU3221BSS	GU3221WPW	GU3221BBN	*25/35mm
GU3210DWPC	GU3210DBPC	GU3210DWPN	GU3210DWSS	GU3210DBSS	GU3210DWPW	GU3210DBBN	*25/35mm
GU3220DWPC	GU3220DBPC	GU3220DWPN	GU3220DWSS	GU3220DBSS	GU3220DWPW	GU3220DBBN	*25/35mm
GU3231WPC	GU3231BPC		GU3231WSS	GU3231BSS	GU3231WPW	GU3231BBN	35mm
GU3234WPC			GU3234WSS	GU3234BSS			35mm
			GU3251WSS				*25/35mm
			GU3252WSS				25/35mm
GU3270WPC	GU3270BPC	GU3270WPN	GU3270WSS	GU3270BSS	GU3270WPW	GU3270BBN	25mm
GU3280WPC	GU3280BPC	GU3280WPN	GU3280WSS	GU3280BSS	GU3280WPW	GU3280BBN	25mm
GU3290WPC	GU3290BPC	GU3290WPN	GU3290WSS	GU3290BSS	GU3290WPW	GU3290BBN	25mm
GU1212WPC	GU1212BPC	GU1212WPN	GU1212WSS	GU1212BSS	GU1212WPW	GU1212BBN	16mm
GU1222WPC	GU1222BPC	GU1222WPN	GU1222WSS	GU1222BSS	GU1222WPW	GU1222BBN	16mm
GU1232WPC	GU1232BPC	GU1232WPN	GU1232WSS	GU1232BSS	GU1232WPW	GU1232BBN	25mm
GU1242WPC	GU1242BPC	GU1242WPN	GU1242WSS	GU1242BSS	GU1242WPW	GU1242BBN	25mm
GU1262WPC	GU1262BPC	GU1262WPN	GU1262WSS	GU1262BSS	GU1262WPW	GU1262BBN	25mm
GU1213WPC	GU1213BPC	GU1213WPN	GU1213WSS	GU1213BSS	GU1213WPW	GU1213BBN	25mm
GU1214WPC	GU1214BPC	GU1214WPN	GU1214WSS	GU1214BSS	GU1214WPW	GU1214BBN	25mm
GU1212RWPC	GU1212RBPC	GU1212RWPN	GU1212RWSS	GU1212RBSS	GU1212RWPW	GU1212RBBN	25mm
GU1212TPC	GU1212TPC	GU1212TPN	GU1212TSS	GU1212TSS	GU1212TPW	GU1212TBN	16mm
GU1222TPC	GU1222TPC	GU1222TPN	GU1222TSS	GU1222TSS	GU1222TPW	GU1222TBN	16mm
GU1232TPC	GU1232TPC	GU1232TPN	GU1232TSS	GU1232TSS	GU1232TPW	GU1232TBN	25mm
GU1242TPC	GU1242TPC	GU1242TPN	GU1242TSS	GU1242TSS	GU1242TPW	GU1242TBN	25mm
GU6211PC	GU6211PC	GU6211PN	GU6211SS	GU6211SS	GU6211PW	GU6211BN	16mm
GU6212PC	GU6212PC	GU6212PN	GU6212SS	GU6212SS	GU6212PW	GU6212BN	25mm
GU6222PC	GU6222PC	GU6222PN	GU6222SS	GU6222SS	GU6222PW	GU6222BN	25mm
GU6232PC	GU6232PC	GU6232PN	GU6232SS	GU6232SS	GU6232PW	GU6232BN	35mm
GU6242PC	GU6242PC	GU6242PN	GU6242SS	GU6242SS	GU6242PW	GU6242BN	35mm
GU6211LVPC	GU6211LVPC	GU6211LVPN	GU6211LVSS	GU6211LVSS	GU6211LVPW	GU6211LVBN	16mm
GU6212LVPC	GU6212LVPC	GU6212LVPN	GU6212LVSS	GU6212LVSS	GU6212LVPW	GU6212LVBN	25mm
GU6222LVPC	GU6222LVPC	GU6222LVPN	GU6222LVSS	GU6222LVSS	GU6222LVPW	GU6222LVBN	25mm
GU6232LVPC	GU6232LVPC	GU6232LVPN	GU6232LVSS	GU6232LVSS	GU6232LVPW	GU6232LVBN	35mm
GU6242LVPC	GU6242LVPC	GU6242LVPN	GU6242LVSS	GU6242LVSS	GU6242LVPW	GU6242LVBN	35mm
GU6212EWPC	GU6212EBPC	GU6212EWPN	GU6212EWSS	GU6212EBSS	GU6212EWPW	GU6212EBBN	25mm
GU6212RWPC	GU6212RBPC	GU6212RWPN	GU6212RWSS	GU6212RBSS	GU6212RWPW	GU6212RBBN	25mm
GU6222EWPC	GU6222EBPC	GU6222EWPN	GU6222EWSS	GU6222EBSS	GU6222EWPW	GU6222EBBN	25mm
GU6000RC1	GU6000RC1	GU6000RC1	GU6000RC1	GU6000RC1	GU6000RC1	GU6000RC1	N/A
GU2210WPC	GU2210BPC	GU2210WPN	GU2210WSS	GU2210BSS	GU2210WPW	GU2210BBN	25mm
GU2213WPC	GU2213BPC	GU2213WPN	GU2213WSS	GU2213BSS	GU2213WPW	GU2213BBN	35mm
GU2211WPC	GU2211BPC	GU2211WPN	GU2211WSS	GU2211BSS	GU2211WPW	GU2211BBN	25mm
GU2214WPC	GU2214BPC	GU2214WPN	GU2214WSS	GU2214BSS	GU2214WPW	GU2214BBN	35mm
GU2214WHWPC	GU2214WHBPC	GU2214WHWPN	GU2214WHWSS	GU2214WHBSS	GU2214WHWPW	GU2214WHBBN	35mm
GU4231WPC	GU4231BPC	GU4231WPN	GU4231WSS	GU4231BSS	GU4231WPW	GU4231BBN	47mm
GU5200WPC	GU5200BPC	GU5200WPN	GU5200WSS	GU5200BSS	GU5200WPW	GU5200BBN	25mm
GU5203WPC	GU5203BPC	GU5203WPN	GU5203WSS	GU5203BSS	GU5203WPW	GU5203BBN	35mm
GU5210WPC	GU5210BPC	GU5210WPN	GU5210WSS	GU5210BSS	GU5210WPW	GU5210BBN	35mm
GU5213WPC	GU5213BPC	GU5213WPN	GU5213WSS	GU5213BSS	GU5213WPW	GU5213BBN	35mm
GU5211WPC	GU5211BPC	GU5211WPN	GU5211WSS	GU5211BSS	GU5211WPW	GU5211BBN	35mm
GU5214WPC	GU5214BPC	GU5214WPN	GU5214WSS	GU5214BSS	GU5214WPW	GU5214BBN	35mm

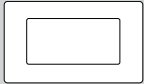
Due to large plate foot print products may not be compatible with flush dual mounting boxes

		Finishes	
		Polished brass white interior	Polished brass black interior
45A control switches		45A 2G DP switch + neon	GU4221WPB GU4221BPB
45A cooker control units		45A DP cooker control unit + 13A switched socket + neon	GU4201WPB GU4201BPB
Shaver socket outlet		115/230V dual voltage	GU7290WPB GU7290BPB
Telephone and data outlets		RJ11 telephone outlet	GU7251WPB GU7251BPB
		Master telephone outlet	GU7261WPB GU7261BPB
		Secondary telephone outlet	GU7262WPB GU7262BPB
		Single RJ45 outlet	GU7271WPB GU7271BPB
TV socket outlets		Single TV/FM coaxial socket	GU7210WPB GU7210BPB
		Twin TV/FM coaxial socket	GU7220WPB GU7220BPB
		Single satellite socket	GU7230WPB GU7230BPB
Euro modular plates (screwless)		1G euro plate	GU8450PB GU8450PB
		2G euro plate	GU8460PB GU8460PB
		4G euro plate	GU8480PB GU8480PB
Blank plates		1G blank plate	GU8210PB GU8210PB
		2G blank plate	GU8220PB GU8220PB
Replacement screws		M3.5 x 50mm countersunk	USCREW50PB USCREW50PB

*Dependent upon wiring configuration, to aid installation 35mm flush steel boxes are recommended.

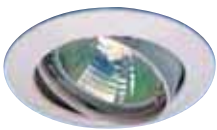

For complementary downlighters that match Ultimate flat plate please see lighting section

Polished chrome white interior	Polished chrome black interior	Pearl nickel white interior	Stainless steel white interior	Stainless steel black interior	White metal white interior	Black nickel black interior	Mounting box depth
							
GU4221WPC	GU4221BPC	GU4221WPN	GU4221WSS	GU4221BSS	GU4221WPW	GU4221BBN	47mm
GU4201WPC	GU4201BPC	GU4201WPN	GU4201WSS	GU4201BSS	GU4201WPW	GU4201BBN	47mm
GU7290WPC	GU7290BPC	GU7290WPN	GU7290WSS	GU7290BSS	GU7290WPW	GU7290BBN	47mm
GU7251WPC	GU7251BPC	GU7251WPN	GU7251WSS	GU7251BSS	GU7251WPW	GU7251BBN	25mm
GU7261WPC	GU7261BPC	GU7261WPN	GU7261WSS	GU7261BSS	GU7261WPW	GU7261BBN	25mm
GU7262WPC	GU7262BPC	GU7262WPN	GU7262WSS	GU7262BSS	GU7262WPW	GU7262BBN	25mm
GU7271WPC	GU7271BPC	GU7271WPN	GU7271WSS	GU7271BSS	GU7271WPW	GU7271BBN	35mm
GU7210WPC	GU7210BPC	GU7210WPN	GU7210WSS	GU7210BSS	GU7210WPW	GU7210BBN	25mm
GU7220WPC	GU7220BPC	GU7220WPN	GU7220WSS	GU7220BSS	GU7220WPW	GU7220BBN	35mm
GU7230WPC	GU7230BPC	GU7230WPN	GU7230WSS	GU7230BSS	GU7230WPW	GU7230BBN	25mm
GU8450PC	GU8450PC	GU8450PN	GU8450SS	GU8450SS	GU8450PW	GU8450BN	**
GU8460PC	GU8460PC	GU8460PN	GU8460SS	GU8460SS	GU8460PW	GU8460BN	**
GU8480PC	GU8480PC	GU8480PN	GU8480SS	GU8480SS	GU8480PW	GU8480BN	**
GU8210PC	GU8210PC	GU8210PN	GU8210SS	GU8210SS	GU8210PW	GU8210BN	N/A
GU8220PC	GU8220PC	GU8220PN	GU8220SS	GU8220SS	GU8220PW	GU8220BN	N/A
USCREW50PC	USCREW50PC	USCREW50PN	USCREW50SS	USCREW50SS	USCREW50PW	USCREW50BN	N/A

Due to large plate foot print products may not be compatible with flush dual mounting boxes



Ultimate low profile

The Ultimate range is complemented with the addition of the low profile range. Smooth curved lines with a slim profile and minimal back projection makes an ideal upgrade from white moulded accessories.

Low profile accessories are available in a choice of brushed or polished chrome, with either black or white interiors. The range includes low profile grid plates.

Features & benefits:

Consumer

- > Large plate footprint avoids the need for additional decorating on retrofits
- > Consistent profile allows accessories to be mounted adjacently
- > Colour matched flat headed screws and eyelets add that finishing touch
- > Slimline, compact neons for a subtle effect

Installer

- > Minimal back projection to allow installation using standard flush mounting boxes for both new and retrofits
- > Full 10AX fluorescent rating on all plate switches
- > Smooth tactile switch action incorporating positive drive switch mechanism
- > Metal capped fuse carriers provide more visible metal on the plate
- > Accessories supplied with both long and short screws for installation flexibility
- > Large in-line angled colour coded terminals to aid cable insertion and selection



GU3520BPC

13A switched sockets

- Dimensions: 88 x 88mm (1 gang), 88 x 148mm (2 gang)
- Mounting box:
 - SB251 (F) 1 gang
 - SB351 (F) 1 gang
 - SB252 (F) 2 gang
 - SB352 (F) 2 gang
- Fix screws: M3.5 x 25mm and 30mm
- BS 1363

Part number	Description	Qty
GU3510***	1 gang switched	1
GU3520***	2 gang switched	1
GU3531***	2 gang DP outboard rocker switched with clean earth	1



GU3580WBC

Round pin socket outlets

- Dimensions: 88 x 88mm
- Mounting box: SB251 (F)
- Fixed screws: M3.5 x 25mm and 30mm
- BS 546

Part number	Description	Qty
GU3580***	5A unswitched	1



GU1522BBC

10AX plate switches

- Dimensions: 88 x 88mm (1-3 gang), 88 x 148mm (4 gang)
- Mounting box:
 - SB161 (F) 1-2 gang
 - SB251 (F) 3 gang
 - SB252 (F) 4 gang
- Fix screws: M3.5 x 25mm and 30mm
- BS EN 60669-1
- BS EN 60947-3 (GU1513***)

Part number	Description	Qty
GU1512***	1 gang 2 way SP	1
GU1522***	2 gang 2 way SP	1
GU1532***	3 gang 2 way SP	1
GU1542***	4 gang 2 way SP	1
GU1514***	1 gang intermediate	1
GU1513***	3 pole isolator	1



GU6522BBC

Mains dimmer switches



- Dimensions: 88 x 88mm (1-2 gang), 88 x 148mm (3 gang)
- Mounting box:
 - SB251 (F) 1-2 gang
 - SB352 (F) 3 gang
- Fix screws: M3.5 x 25mm and 30mm
- BS EN 60669-2-1

Part number	Description	Qty
GU6512**	1 gang 2 way 400W	1
GU6522**	2 gang 2 way 250W	1
GU6532**	3 gang 2 way 250W	1

Note Replace *** with suffix code to denote finish/interior colour required:

Note Replace ** with suffix code to denote finish colour required:

- WPC** Polished chrome with white interior
- BPC** Polished chrome with black interior
- WBC** Brushed chrome with white interior
- BBC** Brushed chrome with black interior



GU2511WBC

20AX DP switches

- Dimensions: 88 x 88mm
- Mounting box: SB351(F)
- Fix screws: M3.5 x 25mm and 30mm
- BS EN 60669-1

Part number	Description	Qty
GU2511***	DP switch with neon	1
GU2513***	DP switch with flex outlet	1



GU5511BPC

13A fused connection units

- Dimensions: 88 x 88mm
- Mounting box:
 - Unswitched SB251 (F)
 - Switched SB351 (F)
- Fix screws: M3.5 x 25mm and 30mm
- BS 1363

Part number	Description	Qty
GU5500***	Unswitched	1
GU5510***	DP switched	1
GU5511***	DP switched with neon	1
GU5514***	DP switched with neon and flex outlet	1



GU4521WBC

45A DP switches

- Dimensions: 148 x 88mm (2 gang)
- Mounting box: SB472 (F) 2 gang
- Fix screws: M3.5 x 25mm and 30mm
- BS EN 60669-1

Part number	Description	Qty
GU4521***	45A 2 gang DP switch with neon	1



GU4501WPC

45A DP cooker controls

- Dimensions: 88 x 148mm
- Mounting box: SB472 (F)
- Fix screws: M3.5 x 25mm and 30mm
- BS 4177

Part number	Description	Qty
GU4501***	DP cooker control unit & 13A switched socket with neons	1



GU7590WBC

Shaver sockets

- Dimensions: 148 x 88mm
- Mounting box: SB472 (F)
- Fix screws: M3.5 x 25mm and 30mm
- BS EN 61558-2-5

Part number	Description	Qty
GU7590***	115/230V dual voltage	1

Special unique design allows perfect fit to 47mm box

Note Replace *** with suffix code to denote finish/interior colour required:

WPC Polished chrome with white interior
BPC Polished chrome with black interior

WBC Brushed chrome with white interior
BBC Brushed chrome with black interior



GU7561WPC

Telephone & data outlets

- Dimensions: 88 x 88mm
- Mounting box:
 - SB251 (F)
 - SB351 (F)
- Fix screws: M3.5 x 25mm and 30mm
- BS EN 41003
- Refer to euro modular range for further combinations

Part number	Description	Qty
GU7561***	Single telephone master	1
GU7562***	Single telephone secondary	1



GU7510BBC

TV outlets

- Dimensions: 88 x 88mm
- Mounting box: SB251 (F)
- Fix screws: M3.5 x 25mm and 30mm
- Products are direct connection and not suitable for common connection
- BS 3041 (where applicable)

Part number	Description	Qty
GU7510***	Single TV/FM socket	1



GU8510PC

Blank plates

- Dimensions: 88 x 88mm (1 gang), 88 x 148mm (2 gang)
- Fix screws: M3.5 x 25mm and 30mm
- BS 5733

Part number	Description	Qty
GU8510**	1 gang	1
GU8520**	2 gang	1

Low profile grid module selection

	White modules		Black modules	
	White rocker	Metal rocker	Black rocker	Metal rocker
BC - brushed chrome	✓	x	✓	x
PC - polished chrome	✓	✓*	✓	✓*

* Select Mirror Steel



GU8550PC

Euro modular plates

- Dimensions: 88 x 88mm (1-2 gang), 88 x 148mm (4 gang)
- Mounted grid supplied with frame
- Refer to module for appropriate mounting box depth

Part number	Description	Qty
GU8550**	1 gang euro modular plate	1
GU8560**	2 gang euro modular plate	1
GU8580**	4 gang euro modular plate	1

For euro module section see page 71

Note Replace *** with suffix code to denote finish/interior colour required:

WPC Polished chrome with white interior
BPC Polished chrome with black interior

WBC Brushed chrome with white interior
BBC Brushed chrome with black interior

Note Replace ** with suffix code to denote finish required:

PC Polished chrome

BC Brushed chrome

Euro plates & modules

The stylish design of screwless flat plates complements the Ultimate range of accessories and provides the complete installation solution. Included in this range are low profile euro plates.

The clip in module and plate design combines simplicity with versatility, facilitating selection and installation for both domestic and commercial applications.

Features & benefits:

Consumer

- > A choice of high quality plate finishes ensures complete coordination with other fixtures and fittings
- > Euro modules are suitable for all decorative and moulded euro format front plates
- > Modules available in black or white to match Ultimate wiring accessory interiors
- > Full range of TV, radio and satellite modules

Installer

- > Flexible system, modules clip straight into the plate from the front for quick and easy installation
- > Euro front plate available in 1, 2 and 4 gang sizes
- > Single 25 x 50mm and double 50 x 50mm modules sizes available



Ultimate grid system

The comprehensive Ultimate grid system, which includes the screwless flat plate range, has been specifically designed to upgrade from screwed to screwless and bring beauty and style to commercial spaces.

With a stylish minimal front plate design, grid plates are available in a wide choice of metal plate finishes, white moulded, and grey or silver grey metal clad. Grid plates are available in 1 - 24 gang combinations.

Features & benefits:

Consumer

- > Modules available for data, TV and telephone installations
- > Electronic dimmer module available to match cover plates
- > Smooth tactile switch action
- > Curved, matching metal capped rockers in a choice of white or black interior
- > A wide range of pre-printed modules are available for a coordinated appearance

Installer

- > Front loaded switch modules
- > Modules can be easily upgraded without the need to remove the mounting grid
- > 6AX, 10AX and 20AX fluorescent rated modules
- > Socket headed plate fixing screws for additional security and reduce plate damage during installation
- > Metal caps are included on all modules from switches, to fuse carriers, flex outlets and data modules
- > All cover plates are supplied with appropriate grid frames



6AX, 10AX & 20AX switch modules - white moulded

- 10AX & 20AX ratings
- Tactile switch action
- BS EN 60669-1

Part number	Description	Qty
GUG202OCW	6AX 2 way retractive and centre off switch module	1
GUG101W	10AX 1 way switch module	1
GUG102W	10AX 2 way switch module	1
GUG102RW	10AX 2 way retractive switch module	1
GUG101W	10AX intermediate switch module	1
GUG201W	20AX 1 way switch module	1
GUG202W	20AX 2 way switch module	1
GUG2020W	20AX 2 way on and off module	1
GUG20DPW	20AX DP switch module	1



20AX secret key modules - white metal rockers

- BS EN 60669-1

Part number	Description	Qty
GUG20DPKWPW	20AX DP key switch module	1
GUG20DPKELWPW	20AX DP key switch module marked EMG.LTG	1
GUG202KWPW	20AX 2 way key switch module	1
GUG202KELWPW	20AX 2 way key switch module marked EMG.LTG	1



Communication modules - white metal rockers

- BS EN 41003
- BS EN 3041 (where applicable)

Part number	Description	Qty
GUGTELMWPW	Master telephone outlet	1
GUGTELSWPW	Secondary telephone outlet	1
GUGRJ11WPW	Single RJ11 data outlet	1
GUGRJ45WPW	Single RJ45 data outlet	1
GUGCOWPW	Single TV/FM coaxial	1
GUGSATWPW	Single satellite	1
GUG13FCUWPW	13A fused connection unit module	1
GUG16COWPW	Flexible outlet (10mm diameter)	1



Blank modules		
Part number	Description	Qty
GUGBW	White blank module	1



20AX DP printed modules - moulded		
<ul style="list-style-type: none"> ■ Pre printed modules for greater flexibility ■ BS EN 60669-1 		
Part number	Description	Qty
GUG20DP**W	20AX DP switch module	1



Indicator modules		
<ul style="list-style-type: none"> ■ 240V ■ BS 5733 		
Part number	Description	Qty
GUGINDWG	Green indicator with white surround	1
GUGINDWO	Orange Indicator with white surround	1
GUGINDWR	Red indicator with white surround	1

Replace ** with the suffix code to denote the printing required:

MW Microwave	HT Heater	WD Waste disposal
CH Cooker hood	WDY Washer/dryer	EF Extractor fan
DW Dishwasher	HO Hob	FA Fan
FZ Freezer	OV Oven	FFZ Fridge freezer
WM Washing machine	BO Boiler	FR Fridge
TD Tumble dryer		



GUG03G



GUG03GGY

Flush moulded front plates

- Supplied with mounting grids
- See page 80 for mounting boxes
- Flush moulded plates are not compatible with electronic touch dimmers
- Grey moulded grid plates help to comply with Part M of the Building Regulations

Part number		Description	Qty
White	Grey		
GUG01G	GUG01GGY	1 module	1
GUG02G	GUG02GGY	2 module	1
GUG03G	GUG03GGY	3 module	1
GUG04G	GUG04GGY	4 module	1
GUG06G		6 module	1
GUG08G		8 module	1
GUG09G		9 module	1
GUG12G		12 module	1
GUG18G		18 module	1
GUG24G		24 module	1



GUG02GMC

Surface metal clad front plates

- Supplied with mounting grids and spacers
- See page 80 for mounting boxes

Part number		Description	Qty
Grey	Silver		
GUG01GMC	GUG01GSMC	1 module	1
GUG02GMC	GUG02GSMC	2 module	1
GUG03GMC	GUG03GSMC	3 module	1
GUG04GMC	GUG04GSMC	4 module	1
GUG06GMC	GUG06GSMC	6 module	1
GUG08GMC	GUG08GSMC	8 module	1
GUG09GMC	GUG09GSMC	9 module	1
GUG12GMC	GUG12GSMC	12 module	1
GUG18GMC	GUG18GSMC	18 module	1
GUG24GMC	GUG24GSMC	24 module	1



Spares

Part number	Description	Qty
UHEXSPW	Hex screws (plate to grid) moulded	10
UHEXSSS	Hex screws (plate to grid) metal clad	10
GUGSHK	Hex screw key	1
GUGKSK	Key switch module spare key	10
GGTKIT	Additional earth terminal	1

Selection table

	Description	Code
6AX & 10AX modules moulded	6AX 2 way retractive and centre off switch module	GUG202OCW
	10AX 1 way switch module	GUG101W
	10AX 2 way switch module	GUG102W
	10AX 2 way retractive switch module	GUG102RW
	10AX intermediate switch module	GUG101W
20AX modules moulded	20AX 1 way switch module	GUG201W
	20AX 2 way switch module	GUG202W
	20AX 2 way on and off module	GUG2020W
	20AX DP switch module	GUG20DPW
20AX printed modules moulded	20AX DP switch module marked microwave	GUG20DPMWW
	20AX DP switch module marked cooker hood	GUG20DPCHW
	20AX DP switch module marked dishwasher	GUG20DPDWW
	20AX DP switch module marked freezer	GUG20DPFZW
	20AX DP switch module marked washing machine	GUG20DPWMW
	20AX DP switch module marked tumble dryer	GUG20DPTDW
	20AX DP switch module marked heater	GUG20DPHTW
	20AX DP switch module marked hob	GUG20DPHOW
	20AX DP switch module marked oven	GUG20DPOVW
	20AX DP switch module marked boiler	GUG20DPBOW
	20AX DP switch module marked waste disposal	GUG20DPWDW
	20AX DP switch module marked extractor fan	GUG20DPEFW
	20AX DP switch module marked fan	GUG20DPFAW
	20AX DP switch module marked fridge freezer	GUG20DPFFZW
	20AX DP switch module marked fridge	GUG20DPFRW
20AX DP switch module marked washer/dryer	GUG20DPWDYW	
20AX secret key modules metal rockers	20AX DP key switch module	GUG20DPKWPW
	20AX DP key switch module marked EMG.LTG	GUG20DPKELWPW
	20AX 2 way key switch module	GUG202KWPW
	20AX 2 way key switch module marked EMG.LTG	GUG202KELWPW
Communication modules metal rockers	Master telephone outlet	GUGTELMWPW
	Secondary telephone outlet	GUGTELSWPW
	Single RJ11 data outlet	GUGRJ11WPW
	Single RJ45 data outlet	GUGRJ45WPW
	Single TV/FM coaxial	GUGCOWPW
	Single satellite	GUGSATWPW
	13A fused connection unit module	GUG13FCUWPW
	Flexible outlet (10mm diameter)	GUG16COWPW
Blank modules	White blank module	GUGBW
Indicator modules	Red neon indicator module	GUGINDWR
	Orange neon indicator module	GUGINDWO
	Green neon indicator module	GUGINDWG
Spares	Hex screws (plate to grid) moulded	UHEXSPW
	Hex screws (plate to grid) metal clad	UHEXSSS
	Hex screw key	GUGSHK
	Key switch module spare key	GUGKSK
	Additional Earth terminal	GGTKIT



Select required switch module and rocker cap



Snap rocker cap onto module



Module is now complete and ready to use



10AX & 20AX switch metal modules

- 10AX & 20AX switch modules available in black or white
- Rocker caps available in all metal finishes
- Pre printed rocker caps
- Clear terminal marking printed onto grey back mouldings ensures easy identification
- Easy assembly
- BS EN 60669-1

Part number	Description	Qty	Part number	Description	Qty
Switch modules			Metal rocker caps		
White surround			GUGR**	Plain rocker cap	6
GUG101MW	10AX 1 way SP	1	GUGRBO**	Marked boiler	6
GUG102MW	10AX 2 way SP	1	GUGRCH**	Marked cooker hood	6
GUG101MW	10AX intermediate SP	1	GUGRDW**	Marked dish washer	6
GUG201MW	20AX 1 way SP	1	GUGREF**	Marked extractor fan	6
GUG202MW	20AX 2 way and off SP	1	GUGRFR**	Marked fridge	6
GUG202MW	20AX 2 way SP	1	GUGRFA**	Marked fan	6
GUG20DPMW	20AX DP	1	GUGRFZ**	Marked freezer	6
			GUGRFRFZ**	Marked fridge/freezer	6
Black surround			GUGRHO**	Marked hob	6
GUG101MB	10AX 1 way SP	1	GUGRHE**	Marked heater	6
GUG102MB	10AX 2 way SP	1	GUGRMW**	Marked microwave	6
GUG101MB	10AX intermediate SP	1	GUGROV**	Marked oven	6
GUG201MB	20AX 1 way SP	1	GUGRTD**	Marked tumble dryer	6
GUG2020MB	20AX 2 way and off SP	1	GUGRWDY**	Marked washer dryer	6
GUG202MB	20AX 2 way SP	1	GUGRWD**	Marked waste disposal	6
GUG20DPMB	20AX DP	1	GUGRWM**	Marked washing machine	6

6AX, 10AX & 20AX switch modules

- Full metal surround on all modules
- 10AX & 20AX ratings
- Tactile switch action
- BS EN 60669-1

Part number	Description	Qty
GUG202OC***	6AX 2 way retractive and centre off	1
GUG102R***	10AX 2 way retractive SP	1
GUG102T***	20AX 2 way SP toggle switch	1
GUG101T***	10AX intermediate toggle	1
GUG20DPK***	20A 1 way DP key operated	1
GUG202K***	20AX 2 way key operated	1
GUG202KEL***	20AX 2 way key operated marked emergency lighting	1

Communication modules

- Full metal surround on all modules
- Easy to fit front locking modules
- BS EN 3041 (where applicable)

Part number	Description	Qty
GUGTELM***	BT master telephone	1
GUGTELS***	BT secondary telephone	1
GUGRJ11***	RJ11 telephone	1
GUGRJ45***	RJ45 data	1
GUGCO***	Direct coaxial TV	1
GUGSAT***	F type satellite	1

Note Replace *** with suffix code to denote finish/interior colour required

Note Replace ** with suffix code to denote finish required

WSS Stainless steel with white interior

WPN Pearl nickel with white interior

BPC Polished chrome with black interior

BSS Stainless steel with black interior

BPB Polished brass with black interior

WPC Polished chrome with white interior

WPW Painted white with white interior

WPB Polished brass with white interior

BBN Black nickel with black interior



Electronic dimmer modules



- Electronic modules are capable of 2 way or multiway dimming
- For lamp suitability check the technical section
- Min load 60W/50VA
- Retractive switch for use with electronic dimmers only
- Not compatible with moulded grid plates
- Modules will require derating when used in multi-gang applications

Part number	Description	Qty
GUGEMDIM***16	300W/VA universal multiway touch dimmer module	1
GUGEMRDIMW16/B16	350W/VA universal multiway touch dimmer module with infra red remote option (black or white)	1
GUGEMW***	2 way & multiway retractive switch*	1
GU6000RC1	1 channel IR remote control	1

*50mA max rating

Fuse connections & flex outlets



- Full metal surround on all modules
- Modules are completely interchangeable
- BS 1363
- BS 5733

Part number	Description	Qty
GUG13FCU***	13A fuse carrier	1
GUG16CO***	Flex outlet up to 10mm ø	1
GUGBW	White moulded blank	1
GUGBB	Black moulded blank	1
GUGB***	Metal finish blank plate	1

Indicator modules



- 240V
- BS 5733

Part number	Description	Qty
White		
GUGINDWG	Green indicator	1
GUGINDWO	Orange Indicator	1
GUGINDWR	Red indicator	1
Black		
GUGINDBG	Green indicator	1
GUGINDBO	Orange Indicator	1
GUGINDBR	Red indicator	1

Low profile, flat plate and screwless front plates



- Flat plate incorporates socket headed screws for additional security and reduced risk of plate damage during installation

Low profile	Flat plate	Screwless	Qty
GUGL01 **	GUG01G**	GUGS01G**	1
GUGL02 **	GUG02G**	GUGS02G**	1
GUGL03 **	GUG03G**	GUGS03G**	1
GUGL04 **	GUG04G**	GUGS04G**	1
GUGL05 **	GUG06G**	GUGS06G**	1
GUGL06 **	GUG08G**	GUGS08G**	1
GUGL08 **	GUG09G**	GUGS09G**	1
	GUG12G**	GUGS12G**	1
	GUG18G**	GUGS18G**	1
	GUG24G**	GUGS24G**	1

Note Replace *** with suffix code to denote finish/interior colour required

Note for flat plate & screwless grid plates, replace ** with suffix code to denote finish required

WSS Stainless steel with white interior **WPN** Pearl nickel with white interior **BPC** Polished chrome with black interior

BSS Stainless steel with black interior **BPB** Polished brass with black interior **WPC** Polished chrome with white interior

WPW Painted white with white interior **WPB** Polished brass with white interior **BBN** Black nickel with black interior

Note for low profile grid plates, replace ** with suffix code to denote finish required

BC Brushed chrome **PC** Polished chrome

		1	2	3	4	6	8	9	12	18	24
Flush											
Moulded	White	GUG01G	GUG02G	GUG03G	GUG04G	GUG06G	GUG08G	GUG09G	GUG12G	GUG18G	GUG24G
Low profile	Brushed chrome	GUGL01BC	GUGL02BC	GUGL03BC	GUGL04BC	GUGL06BC	GUGL08BC				
	Polished chrome	GUGL01PC	GUGL02PC	GUGL03PC	GUGL04PC	GUGL06PC	GUGL08PC				
Flat plate	Stainless steel	GUG01GSS	GUG02GSS	GUG03GSS	GUG04GSS	GUG06GSS	GUG08GSS	GUG09GSS	GUG12GSS	GUG18GSS	GUG24GSS
	Mirror steel	GUG01GMS	GUG02GMS	GUG03GMS	GUG04GMS	GUG06GMS	GUG08GMS	GUG09GMS	GUG12GMS	GUG18GMS	GUG24GMS
	Polished brass	GUG01GPB	GUG02GPB	GUG03GPB	GUG04GPB	GUG06GPB	GUG08GPB	GUG09GPB	GUG12GPB	GUG18GPB	GUG24GPB
	Black nickel	GUG01GBN	GUG02GBN	GUG03GBN	GUG04GBN	GUG06GBN	GUG08GBN	GUG09GBN	GUG12GBN	GUG18GBN	GUG24GBN
	Pearl nickel	GUG01GPN	GUG02GPN	GUG03GPN	GUG04GPN	GUG06GPN	GUG08GPN	GUG09GPN	GUG12GPN	GUG18GPN	GUG24GPN
	White metal	GUG01GPW	GUG02GPW	GUG03GPW	GUG04GPW	GUG06GPW	GUG08GPW	GUG09GPW	GUG12GPW	GUG18GPW	GUG24GPW
	Screwless	Stainless steel	GUGS01GSS	GUGS02GSS	GUGS03GSS	GUGS04GSS	GUGS06GSS	GUGS08GSS	GUGS09GSS	GUGS12GSS	GUGS18GSS
	Mirror steel	GUGS01GMS	GUGS02GMS	GUGS03GMS	GUGS04GMS	GUGS06GMS	GUGS08GMS	GUGS09GMS	GUGS12GMS	GUGS18GMS	GUGS24GMS
	Polished brass	GUGS01GPB	GUGS02GPB	GUGS03GPB	GUGS04GPB	GUGS06GPB	GUGS08GPB	GUGS09GPB	GUGS12GPB	GUGS18GPB	GUGS24GPB
	Black nickel	GUGS01GBN	GUGS02GBN	GUGS03GBN	GUGS04GBN	GUGS06GBN	GUGS08GBN	GUGS09GBN	GUGS12GBN	GUGS18GBN	GUGS24GBN
	Pearl nickel	GUGS01GPN	GUGS02GPN	GUGS03GPN	GUGS04GPN	GUGS06GPN	GUGS08GPN	GUGS09GPN	GUGS12GPN	GUGS18GPN	GUGS24GPN
	White metal	GUGS01GPW	GUGS02GPW	GUGS03GPW	GUGS04GPW	GUGS06GPW	GUGS08GPW	GUGS09GPW	GUGS12GPW	GUGS18GPW	GUGS24GPW
Dimensions		88 x 88mm	88 x 88mm	88 x 148mm	88 x 148mm	156 x 156mm	156 x 156mm	216 x 156mm	216 x 156mm	398 x 156mm	398 x 156mm

		1	2	3	4	6	8	9	12	18	24
Flush mounting boxes											
		GBG01	GBG01	GBG02	GBG02	GBG03	GBG03	GBG04F	GBG04F	GBG06F	GBG06F
Dimensions		76 x 76 42mm	76 x 76 42mm	136 x 76 42mm	136 x 76 42mm	136 x 136 42mm	136 x 136 42mm	193 x 133 42mm	193 x 133 42mm	374 x 133 42mm	374 x 133 42mm

		1	2	3	4	6	8	9	12	18	24
Surface											
Metal clad	Metal clad grey	GUG01GMC	GUG02GMC	GUG03GMC	GUG04GMC	GUG06GMC	GUG08GMC	GUG09GMC	GUG12GMC	GUG18GMC	GUG24GMC
	Metal clad silver	GUG01GSMC	GUG02GSMC	GUG03GSMC	GUG04GSMC	GUG06GSMC	GUG08GSMC	GUG09GSMC	GUG12GSMC	GUG18GSMC	GUG24GSMC
Dimensions		88 x 88mm	88 x 88mm	88 x 148mm	88 x 148mm	156 x 156mm	156 x 156mm	216 x 156mm	216 x 156mm	398 x 156mm	398 x 156mm

		1	2	3	4	6	8	9	12	18	24
Surface mounting											
Grey		GBG01	GBG01	GBG02	GBG02	GBG03	GBG03	GBG04S	GBG04S	GBG06S	GBG06S
Silver		GBGS01	GBGS01	GBGS02	GBGS02	GBGS03	GBGS03	GBGS04S	GBGS04S	GBGS06S	GBGS06S
Dimensions		76 x 76 42mm	76 x 76 42mm	136 x 76 42mm	136 x 76 42mm	136 x 136 42mm	136 x 136 42mm	202 x 136 42mm	202 x 136 42mm	334 x 136 42mm	384 x 136 42mm



Fit installation box and mounting grid. Pull through cables, cut and strip to length.



Terminate each cable to the appropriate switch, (clear terminal markings).



Once wired the modules, simply but securely clip into the mounting grid.



Finally after decorating, fit the cover plate.



Front plates are available in a choice of 11 finishes - Polished Brass, Mirror Steel, Stainless Steel, Pearl Nickel, Black Nickel, Brushed Chrome, White Metal, White Moulded, Metal Clad Grey and Silver.

*All cover plates are supplied with appropriate grid frames

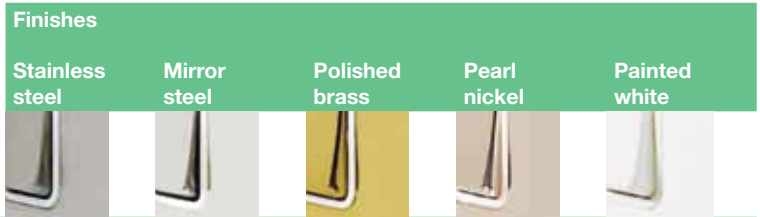

Choose module + cap to create following module		Module	Plain rocker cap				
10AX & 20AX switch component modules	10AX 1 way SP	GUG101MW	GUGRSS	GUGRMS	GUGRPB	GUGRPN	GUGRPW
	10AX 2 way SP	GUG102MW	GUGRSS	GUGRMS	GUGRPB	GUGRPN	GUGRPW
	10AX intermediate SP	GUG10IMW	GUGRSS	GUGRMS	GUGRPB	GUGRPN	GUGRPW
	20AX 1 way SP	GUG201MW	GUGRSS	GUGRMS	GUGRPB	GUGRPN	GUGRPW
	20AX 2 way and off SP	GUG2020MW	GUGRSS	GUGRMS	GUGRPB	GUGRPN	GUGRPW
	20AX 2 way SP	GUG202MW	GUGRSS	GUGRMS	GUGRPB	GUGRPN	GUGRPW
	20AX DP	GUG20DPMW	GUGRSS	GUGRMS	GUGRPB	GUGRPN	GUGRPW
Choose module + cap to create following module		Module	Plain rocker cap				
20AX DP printed switch component modules	Marked boiler	GUG20DPMW	GUGRBOSS	GUGRBOMS	GUGRBOPB	GUGRBOPN	GUGRBOPW
	Marked cooker hood	GUG20DPMW	GUGRCHSS	GUGRCHMS	GUGRCHPB	GUGRCHPN	GUGRCHPW
	Marked dish washer	GUG20DPMW	GUGRDWSS	GUGRDWMS	GUGRDWPB	GUGRDWPN	GUGRDWPW
	Marked extractor fan	GUG20DPMW	GUGREFSS	GUGREFMS	GUGREFPB	GUGREFPN	GUGREFPW
	Marked fridge	GUG20DPMW	GUGRFRSS	GUGRFRMS	GUGRFRPB	GUGRFRPN	GUGRFRPW
	Marked fan	GUG20DPMW	GUGRFASS	GUGRFAMS	GUGRFAPB	GUGRFAPN	GUGRFAPW
	Marked freezer	GUG20DPMW	GUGRFZSS	GUGRFZMS	GUGRFZPB	GUGRFZPN	GUGRFZPW
	Marked fridge/freezer	GUG20DPMW	GUGRFRFZSS	GUGRFRFZMS	GUGRFRFZPB	GUGRFRFZPN	GUGRFRFZPW
	Marked hob	GUG20DPMW	GUGRHOSS	GUGRHOMS	GUGRHOPB	GUGRHOPN	GUGRHOPW
	Marked heater	GUG20DPMW	GUGRHESS	GUGRHEMS	GUGRHEPB	GUGRHEPN	GUGRHEPW
	Marked microwave	GUG20DPMW	GUGRMWSS	GUGRMWMS	GUGRMWPB	GUGRMWPN	GUGRMWPW
	Marked oven	GUG20DPMW	GUGROVSS	GUGROVMS	GUGROVPB	GUGROVPN	GUGROVPW
	Marked tumble dryer	GUG20DPMW	GUGRTDSS	GUGRTDMS	GUGRTDPB	GUGRTDPN	GUGRTDPW
	Marked washer dryer	GUG20DPMW	GUGRDWYSS	GUGRDWYMS	GUGRDWYPB	GUGRDWYPN	GUGRDWYPW
	Marked waste disposal	GUG20DPMW	GUGRWDSS	GUGRWDMS	GUGRWDPB	GUGRWDPN	GUGRWDPW
	Marked washing machine	GUG20DPMW	GUGRWMSS	GUGRWMS	GUGRWMPB	GUGRWMPN	GUGRWMPW
6AX & 10AX modules	6AX 2 way retractive and centre off switch module	GUG202OCWSS	GUG202OCWMS	GUG202OCWPB	GUG202OCWPN	GUG202OCWPW	
	10AX 2 way retractive switch module	GUG102RWSS	GUG102RWMS	GUG102RWPB	GUG102RWPN	GUG102RWPW	
	10AX 2 way toggle switch module	GUG102TWSS	GUG102TWMS	GUG102TWPB	GUG102TWPN	GUG102TWPW	
	10AX intermediate toggle switch module	GUG10ITWSS	GUG10ITWMS	GUG10ITWPB	GUG10ITWPN	GUG10ITWPW	
20AX secret key modules	20AX DP key switch module	GUG20DPKWSS	GUG20DPKWMS	GUG20DPKWPB	GUG20DPKWPN	GUG20DPKWPPW	
	20AX 2 way key switch module	GUG202KWSS	GUG202KWMS	GUG202KWPB	GUG202KWPN	GUG202KWPPW	
	20AX 2 way key switch module marked EMG.LTG	GUG202KELWSS	GUG202KELWMS	GUG202KELWPB	GUG202KELWPN	GUG202KELWPPW	
Communication modules	Master telephone outlet	GUGTELMWSS	GUGTELMWMS	GUGTELMWPB	GUGTELMWPN	GUGTELMWPPW	
	Secondary telephone outlet	GUGTELSWSS	GUGTELSWMS	GUGTELSWPB	GUGTELSWPN	GUGTELSWPPW	
	Single RJ11 data outlet	GUGRJ11WSS	GUGRJ11WMS	GUGRJ11WPB	GUGRJ11WPN	GUGRJ11WPPW	
	Single RJ45 data outlet	GUGRJ45WSS	GUGRJ45WMS	GUGRJ45WPB	GUGRJ45WPN	GUGRJ45WPPW	
	Single TV/FM coaxial	GUGCOWSS	GUGCOWMS	GUGCOWPB	GUGCOWPN	GUGCOWPPW	
	Single satellite	GUGSATWSS	GUGSATWMS	GUGSATWPB	GUGSATWPN	GUGSATWPPW	
Electronic dimmer	Electronic 300W/VA 2 way & multiway standard dimmer module	GUGEMDIMWSS16	GUGEMDIMWMS16	GUGEMDIMWBP16	GUGEMDIMWPN16	GUGEMDIMWPP16	
	Electronic 300W/VA infra red dimmer module	GUGEMRDIMW16	GUGEMRDIMWMS16	GUGEMRDIMWBP16	GUGEMRDIMWPN16	GUGEMRDIMWPP16	
	2 way retractive switch	GUGEMWWSS16	GUGEMWWMS16	GUGEMWWBP16	GUGEMWWPN16	GUGEMWWPP16	
	1 channel remote control	GU6000RC116	GU6000RC116	GU6000RC116	GU6000RC116	GU6000RC116	
Connection unit & flex outlet	13A fused connection unit module	GUG13FCUWSS	GUG13FCUWMS	GUG13FCUWPB	GUG13FCUWPN	GUG13FCUWPPW	
	Flex outlet (10mm dia)	GUG16COWSS	GUG16COWMS	GUG16COWPB	GUG16COWPN	GUG16COWPPW	
Blank modules	Blank module metal finish	GUGBWSS	GUGBWMS	GUGBWPB	GUGBWPN	GUGBWPW	
	Blank module plastic	GUGWB					
Indicator modules	Red neon indicator module	GUGINDWR					
	Orange neon indicator module	GUGINDWO					
	Green neon indicator module	GUGINDWG					
Spares	Hex screws (plate to grid)		UHEXSSS	UHEXSMS	UHEXSPB	UHEXSPN	UHEXSPW
	Hex screw key	GUGSHK					
	Key switch module spare key	GUGKSK					
	Additional Earth terminal	GGTKIT					

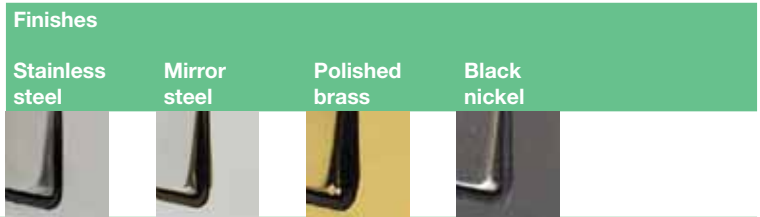

Choose module + cap to create following module		Module	Plain rocker cap			
			Stainless steel	Mirror steel	Polished brass	Black nickel
10AX & 20AX switch component modules	10AX 1 way SP	GUG101MB	GUGRSS	GUGRMS	GUGRPB	GUGRBN
	10AX 2 way SP	GUG102MB	GUGRSS	GUGRMS	GUGRPB	GUGRBN
	10AX intermediate SP	GUG10IMB	GUGRSS	GUGRMS	GUGRPB	GUGRBN
	20AX 1 way SP	GUG201MB	GUGRSS	GUGRMS	GUGRPB	GUGRBN
	20AX 2 way and off SP	GUG2020MB	GUGRSS	GUGRMS	GUGRPB	GUGRBN
	20AX 2 way SP	GUG202MB	GUGRSS	GUGRMS	GUGRPB	GUGRBN
	20AX DP	GUG20DPMB	GUGRSS	GUGRMS	GUGRPB	GUGRBN
Choose module + cap to create following module		Module				
20AX DP printed switch component modules	Marked boiler	GUG20DPMB	GUGRBOSS	GUGRBOMS	GUGRBOPB	GUGRBOBN
	Marked cooker hood	GUG20DPMB	GUGRCHSS	GUGRCHMS	GUGRCHPB	GUGRCHBN
	Marked dish washer	GUG20DPMB	GUGRDWSS	GUGRDWMS	GUGRDWPB	GUGRDWBN
	Marked extractor fan	GUG20DPMB	GUGREFSS	GUGREFMS	GUGREFPB	GUGREFBN
	Marked fridge	GUG20DPMB	GUGRFRSS	GUGRFRMS	GUGRFRPB	GUGRFRBN
	Marked fan	GUG20DPMB	GUGRFASS	GUGRFAMS	GUGRFAPB	GUGRFABN
	Marked freezer	GUG20DPMB	GUGRFZSS	GUGRFZMS	GUGRFZPB	GUGRFZBN
	Marked fridge/freezer	GUG20DPMB	GUGRFRFZSS	GUGRFRFZMS	GUGRFRFZPB	GUGRFRFZBN
	Marked hob	GUG20DPMB	GUGRHOSS	GUGRHOMS	GUGRHOPB	GUGRHOBN
	Marked heater	GUG20DPMB	GUGRHESS	GUGRHEMS	GUGRHEPB	GUGRHEBN
	Marked microwave	GUG20DPMB	GUGRMWSS	GUGRMWMS	GUGRMWPB	GUGRMWBN
	Marked oven	GUG20DPMB	GUGROVSS	GUGROVMS	GUGROVPB	GUGROVBN
	Marked tumble dryer	GUG20DPMB	GUGRTDSS	GUGRTDMS	GUGRTDPB	GUGRTDBN
	Marked washer dryer	GUG20DPMB	GUGRDWYSS	GUGRDWYMS	GUGRDWYPB	GUGRDWYBN
	Marked waste disposal	GUG20DPMB	GUGRDWSS	GUGRDWMS	GUGRDWPB	GUGRDWBN
	Marked washing machine	GUG20DPMB	GUGRWMSS	GUGRWMS	GUGRWMPB	GUGRWMBN
	6AX & 10AX modules	6AX 2 way retractive and centre off switch module	GUG202OCBSS	GUG202OCBMS	GUG202OCBPB	GUG202OCBBN
10AX 2 way retractive switch module		GUG102RBSS	GUG102RBMS	GUG102RBPB	GUG102RBBN	
10AX 2 way toggle switch module		GUG102TBSS	GUG102TBMS	GUG102TBPB	GUG102TBBN	
10AX intermediate toggle switch module		GUG10ITBSS	GUG10ITBMS	GUG10ITBPB	GUG10ITBBN	
20AX secret key modules	20AX DP key switch module	GUG20DPKBSS	GUG20DPKBMS	GUG20DPKBPB	GUG20DPKBBN	
	20AX 2 way key switch module	GUG202KBSS	GUG202KBMS	GUG202KBPB	GUG202KBBN	
	20AX 2 way key switch module marked EMG.LTG	GUG202KELBSS	GUG202KELBMS	GUG202KELBPB	GUG202KELBBN	
Communication modules	Master telephone outlet	GUGTELBSS	GUGTELBMS	GUGTELBPB	GUGTELBBN	
	Secondary telephone outlet	GUGTELSBSS	GUGTELSBMS	GUGTELSBPB	GUGTELSBBN	
	Single RJ11 data outlet	GUGRJ11BSS	GUGRJ11BMS	GUGRJ11BPB	GUGRJ11BBN	
	Single RJ45 data outlet	GUGRJ45BSS	GUGRJ45BMS	GUGRJ45BPB	GUGRJ45BBN	
	Single TV/FM coaxial	GUGCOBSS	GUGCOBMS	GUGCOBPB	GUGCOBBN	
	Single satellite	GUGSATBSS	GUGSATBMS	GUGSATBPB	GUGSATBBN	
Electronic dimmer	Electronic 300W/VA 2 way & multiway standard dimmer module	GUGEMDIMBSS16	GUGEMDIMBMS16	GUGEMDIMBPB16	GUGEMDIMBBN16	
	Electronic 350W/VA infra red dimmer module	GUGEMRDIMB16	GUGEMRDIMBMS16	GUGEMRDIMBPB16	GUGEMRDIMBBN16	
	2 way retractive switch	GUGEMWBSS16	GUGEMWBMS16	GUGEMWBPB16	GUGEMWBBN16	
	1 channel remote control	GU6000RC116	GU6000RC116	GU6000RC116	GU6000RC116	
Connection unit & flex outlet	13A fused connection unit module	GUG13FCUBSS	GUG13FCUBMS	GUG13FCUBPB	GUG13FCUBBN	
	Flex outlet (10mm dia)	GUG16COBSS	GUG16COBMS	GUG16COBPB	GUG16COBBN	
Blank modules	Blank module metal finish	GUGBBSS	GUGBBMS	GUGBBPB	GUGBBBN	
	Blank module plastic	GUGBB				
Indicator modules	Red neon indicator module	GUGINDBR				
	Orange neon indicator module	GUGINDBO				
	Green neon indicator module	GUGINDBG				
Spares	Hex screws (plate to grid)					
	Hex screw key	GUGSHK				
	Key switch module spare key	GUGKSK				
	Additional Earth terminal	GGTKIT				

Rocca range

The wide rocker switches that give this range its name make for easy use and distinctive looks. Available in three high quality finishes, the Rocca modular system provides both style and versatility for commercial and domestic applications.

The range also benefits from the frame and modules being installed separately from the decorative plate, so all building and decorating work can be completed before you install that final finishing touch.

Subject to availability.



Features & benefits:

Consumer

- > Concealed fixing screws for streamlined, screwless appearance
- > High quality polycarbonate
- > Choice of finishes
- > Wide rockers for ease of use

Installer

- > Optional interchangeable frame
- > In-line, angled terminals and crosshead captive screws for easy installation
- > Clear, colour-coded terminal markings to aid selection
- > Easy to remove snap-on snap-off front plate for ease of decoration



GRME3020

13A socket outlets

- Dimensions: 87 x 87mm (1 gang), 87 x 147mm (2 gang)
- Mounting Box:
 - SB251 (F) GPAT1G25 (S) 1 gang
 - SB252 (F) GPAT2G25 (S) 2 gang
- Fix screws: M3.5 x 30mm
- Graphite interior with mercury frame
- Graphite interior with graphite frame
- Stone interior with stone frame
- BS 1363

Part number	Description	Qty
GR**3010	1 gang switched	1
GR**3020	2 gang switched	1



GRME1022

16A plate switches

- Dimensions: 87 x 87mm
- Mounting Box: SB251 (F) GPAT1G25 (S)
- Fix screws: M3.5 x 25mm
- Mercury interior with mercury frame
- Graphite interior with graphite frame
- Stone interior with stone frame
- BS EN 60669-1

Part number	Description	Qty
GR**1012	1 gang 2 way	1
GR**1022	2 gang 2 way	1
GR**1032	3 gang 2 way	1



GRGT6022

Mains dimmer switches



- Dimensions: 87 x 87mm
- Mounting Box: SB351 (F) GPAT1G35 (S)
- Fix screws: M3.5 x 25mm
- Graphite interior with mercury frame
- Graphite interior with graphite frame
- Stone interior with stone frame
- BS EN 60669-2-1

Part number	Description	Qty
GR**6012	1 gang 2 way 400W	1
GR**6022	2 gang 2 way 250W	1



GRST4011

20A & 45A DP switches

- Dimensions: 87 x 87mm
- Mounting Box:
 - SB351 (F) GPAT1G35 (S) 20A
 - SB471 (F) GPAT1G47 (S) 45A
- Fix screws: M3.5 x 25mm
- Graphite interior with mercury frame
- Graphite interior with graphite frame
- Stone interior with stone frame
- BS EN 60669-1

Part number	Description	Qty
GR**2010	20A DP	1
GR**4011	45A DP with neon	1

Note Replace ** with suffix code to denote finish required
GT Graphite **ST** Stone **PW** White



GRME5010

13A fused connection units

- Dimensions: 87 x 87mm
- Mounting Box: SB351 (F) GPAT1G35 (S)
- Fix screws: M3.5 x 25mm
- Graphite interior with mercury frame
- Graphite interior with graphite frame
- Stone interior with stone frame
- BS 1363

Part number	Description	Qty
GR**5010	Switched	1



GRST7062

Communication outlets

- Dimensions: 87 x 87mm
- Mounting Box: SB251 (F) GPAT1G25 (S)
- Fix screws: M3.5 x 25mm
- Graphite interior with mercury frame
- Graphite interior with graphite frame
- Stone interior with stone frame
- BS EN 41003

Part number	Description	Qty
GR**7051	Single RJ11	1
GR**7061	Single master	1
GR**7062	Single secondary	1
GR**7010	Single TV/FM	1



GRGT7016

TV & telephone combined outlets

- Dimensions: 87 x 87mm
- Mounting Box: SB251 (F) GPAT1G25 (S)
- Fix screws: M3.5 x 25mm
- Graphite interior with mercury frame
- Graphite interior with graphite frame
- Stone interior with stone frame
- BS EN 41003
- BS 3041 (where applicable)

Part number	Description	Qty
GR**7016	Telephone co-axial	1

Note Replace ** with suffix code to denote finish required
GT Graphite **ST** Stone **PW** White



GRL101ST

10AX modules

■ BS EN 60669-1

Part number	Description	Qty
GRL101**	10AX 1 way	1
GRL102**	10AX 2 way	1
GRL102R**	10AX 2 way retractive	1
GRL10I**	10AX intermediate	1



GRL202KST

20AX modules

■ Key supplied with key switch

■ BS EN 60669-1

Part number	Description	Qty
GRL201**	20AX 1 way	1
GRL202**	20AX 2 way	1
GRL2020**	20AX 2 way and off	1
GRL202K**	20AX 2 way key	1
GRL20DP**	20AX DP	1
GRL20DPN**	20AX DP with neon	1
GRL20DPK**	20AX DP key	1



GRL13FCUGT

Fused connection unit modules

■ BS 1363

Part number	Description	Qty
GRL13FCU**	13A fused	1



GRL13USPW

13A socket outlet module

■ BS 1363

Part number	Description	Qty
GRL13USPW	Unswitched - White	1



GRLTELST

TV and telephone outlets

■ BS EN 41003

■ BS EN 3041 (where applicable)

Part number	Description	Qty
GRLCOAX**	Coaxial outlet	1
GRLTEL**	BT secondary telephone	1



GRLINDGGT

Accessories

■ 240V

■ BS 5733

Part number	Description	Qty
GRLINDR**	Red indicator	1
GRLINDO**	Orange indicator	1
GRLINDG**	Green indicator	1
GRLIBP**	Blank module	1
GRLCO**	Cord outlet (10mm dia.)	1

Note Replace ** with suffix code to denote finish required

GT Graphite ST Stone PW White



GRLS08GSS

Screwless cover plate

- Cover plates are supplied with the correct number of grid frames
- BS 5733

Part number	Description	Qty
GRLS01G**	1 gang plate	1
GRLS02G**	2 gang plate	1
GRLS03G**	3 gang plate	1
GRLS04G**	4 gang plate	1
GRLS06G**	6 gang plate	1
GRLS08G**	8 gang plate	1
GRLS09G**	9 gang plate	1
GRLS012G**	12 gang plate	1



GBG01

Flush mounting boxes

- All boxes are supplied with 25mm knockouts and earth terminals
- BS 5733

Part number	Description	Qty
GBG01	1 - 2 gang mounting box	10
GBG02	3 - 4 gang mounting box	5
GBG03	6 - 8 gang mounting box	1
GBG04F	9 - 12 gang mounting box	1

Note Replace ** with suffix code to denote finish required
PW White metal **SS** Stainless steel **MS** Mirror steel

Timeless &
traditional



Exclusive
range

Exclusive square edge white moulded

This highly successful Exclusive square edge range of white moulded wiring accessories maintains the superb quality and easy to install technical specification with exceptional value for money.

Features & benefits:

Consumer

- > Timeless traditional profile suitable for both domestic and commercial use
- > Outstanding value for money

Installer

- > Optional cable outlet facility provides the choice of either surface or flush cable access
- > Plate profiles match across the entire range
- > DP socket outlets provide both easy access to connections together with twin earth terminals for high integrity earthing
- > Easy access generous terminals



GSKTSW2G

13A socket outlets

- Dimensions: 86 x 86mm (1 gang), 86 x 146mm (2 gang)
- Mounting box:
 - SB251 (F) 1 gang GPAT1G25 (S)
 - SB252 (F) 2 gang GPAT2G25 (S)
- Fix screws: M3.5 x 30mm
- BS 1363
- 'V' locator socket includes grooves for fast insertion of plug

Part number	Description	Qty
GSKT1G	1 gang unswitched	10
GSKT2G	2 gang unswitched	5
GSKTSW1G	1 gang switched	10
GSKTSW2G2	2 gang switched	5
GSKTSWDP1G	1 gang DP switched	5
GSKTSWDP2G	2 gang DP switched	1
GSKTSW2GV	2 gang switched 'V' locator	5

Note: GSKTSW2G has now migrated to **GSKTSW2G2**



GSKTSW3G
(not to scale)

13A 3 gang socket outlet

- Dimensions: 86 x 205mm
- Mounting box: GPAT3G25 (S)
- Fix screws: M3.5 x 30mm
- BS 1363

Part number	Description	Qty
GSKTSW3G	3 gang switched and fused	5



GSKT5A1G

Round pin socket outlets

- Dimensions: 86 x 86mm
- Mounting box: SB251 (F) GPAT1G25 (S)
- Fix screws: M3.5 x 30mm
- BS 546

Part number	Description	Qty
GSKT2A1G	2A unswitched	10
GSKT5A1G	5A unswitched	10
GSKT15A1G	15A unswitched	10
GSKTSW15A1G	15A switched	10



LSKT1GR

DP RCD protected socket/outlets

- Dimensions: 86 x 146mm
- Mounting box: SB252 (F) GPAT2G25 (S)
- Fix screws: M3.5 x 30mm
- BS 7288
- Electronic latch - active control*
- Mechanical latch - passive control**

Part number	Description	Qty
LSKT1GR	*1 gang RCD 30mA active control	1
LSKT2GR	*2 gang RCD 30mA active control	1
LSKT2GRP	**2 gang RCD 30mA passive control	1

* Active control - device will fail safe in the event of loss of supply. Suitable for domestic use.

** Passive control - device will only trip in the event of a fault. Suitable for freezers and commercial applications.



LSKT2GR

Note: All 2 gang sockets include twin earth terminals as standard, enabling high integrity earthing. To aid flush installation 35mm steel boxes are recommended.



GSW1G2W

6AX plate switches

- Dimensions: 86 x 86mm (1-3 gang), 86 x 146mm (4 gang)
- Mounting box:
 - SB161 (F) GPAT1G16 (S) 1-2 gang
 - SB251 (F) GPAT1G25 3 gang
 - SB252 (F) GPAT2G25 (S) 4 gang
- Fix screws: M3.5 x 20mm
- BS EN 60669-1
- BS EN 60947-3 (GSWIS02)
- BS 3676 (GSWTPS)

Part number	Description	Qty
GSW1G1W	1 gang 1 way	10
GSW1G2W	1 gang 2 way	10
GSW2G2W	2 gang 2 way	10
GSW3G2W	3 gang 2 way	10
GSW4G2W	4 gang 2 way	10
GSWISO2	3 pole isolator	10
GSWTPS	Triple pole switch	10
GSWINT	1 gang intermediate	10
GSW1G2WR	*1 gang 2 way retractive	10
GSW1G2WRP	*1 gang 2 way retractive marked 'press'	10
GSW1G2WRB	*1 gang 2 way retractive marked with bell symbol	10

* 6A rated



GSWA1G2W

- Dimensions: 33 x 86mm (1 gang), 33 x 148mm (2 gang)
- Mounting box:
 - SBA251A (F) GPAT1G16A (S) 1 gang
 - SBA252A (F) GPAT2G16A (S) 2 gang
- Fix screws: M3.5 x 20mm
- BS EN 60669-1

Part number	Description	Qty
GSWA1G2W	10AX 1 gang 2 way architrave	10
GSWA2G2W	10AX 2 gang 2 way architrave	10

Slimline rotary dimmers



- Dimensions: 86 x 86mm
- Mounting box:
 - SB161 (F) GPAT1G16 (S) 1 gang 1 way
 - SB251 (F) GPAT1G25 (S) 1-2 gang 2 way
- Fix screws: M3.5 x 30mm
- For use with incandescent lamps only
- BS EN 60669-2-1

Part number	Description	Qty
GD1G1W	1 gang 1 way 60-250W*	1
GD2G1W	2 gang 1 way 60-250W	1
GD1G1W4	1 gang 1 way 60-400W*	1

* Ultra slim module for mounting on 16mm box

Push dimmers



- Dimensions: 86 x 86mm (1 & 2 gang), 86 x 146mm (3 & 4 gang)
- Mounting box:
 - SB251 (F) GPAT1G25 (S) 1-2 gang
 - SB252 (F) GPAT2G25 (S) 3-4 gang
- Fix screws: M3.5 x 30mm
- For use with incandescent lamps only
- BS EN 60669-2-1

Part number	Description	Qty
GD1G2W	1 gang 2 way 250W	1
GD1G2W4	1 gang 2 way 400W	1
GD2G2W	2 gang 2 way 250W	1
GD3G2W	3 gang 2 way 250W	1
GD4G2W	4 gang 2 way 250W	1



GD3G2W

Note Mains dimmer switches are not suitable on LV circuits. See technical section. Soft start low voltage dimmers are only suitable for dimming wire wound laminated, toroidal and some electronic transformers- not suitable for dimming fluorescent or incandescent lamps.



GLVD1G1W4

Note Mains dimmer switches are not suitable on LV circuits. See technical section. Soft start low voltage dimmers are only suitable for dimming wire wound laminated, toroidal and some electronic transformers— not suitable for dimming fluorescent or incandescent lamps.

Soft start low voltage dimmers

- Dimensions: 86 x 86mm
- Mounting box:
 - SB161 (F) GPAT1G16 (S) 1 gang 1 way
 - SB251 (F) GPAT1G25 (S) 1-2 gang 2 way
- Fix screws: M3.5 x 30mm
- BS EN 60669-2-1

Part number	Description	Qty
GLVD1G1W	Rotary 1G 1 way 60-250VA	1
GLVD1G2W	Push 1G 2 way 60-250VA	1
GLVD2G1W	Rotary 2G 1 way 60-250VA	1
GLVD2G2W	Push 2G 2 way 60-250VA	1
GLVD1G1W4	Rotary 1G 1 way 60-400VA	1
GLVD1G2W4	Push 1G 2 way 60-400VA	1



GSWDPN20A

20AX DP switches

- Dimensions: 86 x 86mm
- Mounting box: SB251 (F) GPAT1G25 (S)
- Fix screws: M3.5 x 30mm
- BS EN 60669-1

Part number	Description	Qty
GSWDP20A	DP	10
GSWDPN20A	DP with neon	10
GSWDP20AFO	DP with flex outlet	10
GSWDPN20AFO	DP with flex outlet + neon	10
GSWDPN20AFOWH	DP with flex outlet (marked water heater)	10



GSPUR

13A fused connection units

- Dimensions: 86 x 86mm
- Mounting box: SB251 (F) GPAT1G25 (S)
- Fix screws: M3.5 x 30mm
- BS 1363

Part number	Description	Qty
GSPUR	*13A unswitched	10
GSPUR3A	*3A unswitched	10
GNSPUR	*13A unswitched with neon	10
GSWSPUR	*13A DP switched	10
GSWNSPUR	*13A DP switched with neon	10
GFOPLATE	20A front entry flex outlet plate	10
GSFOPLATE	25A side entry flex outlet plate	10

*optional flex outlet facility

Exclusive engraved range

	20A DP Control switch				13A Fused connection unit		
	DP switch	DP with neon	DP with flex outlet	DP with flex outlet & neon	Unswitched	Switched	Switched with neon
Air conditioner			GSWDP20AFOAC	GSWDPN20AFOAC			
Boiler						GSWSPURBO	GSWNSPURBO
Cooker hood						GSWSPURCH	GSWNSPURCH
Dishwasher						GSWSPURDW	GSWNSPURDW
Extractor fan						GSWSPURF	GSWNSPURF
Fan						GSWSPURFA	GSWNSPURFA
Freezer						GSWSPURFZ	GSWNSPURFZ
Fridge						GSWSPURFR	GSWNSPURFR
Fridge/freezer						GSWSPURFFZ	GSWNSPURFFZ
Hob						GSWSPURHO	GSWNSPURHO
Heater	GSWDP20AHT	GSWDPN20AHT	GSWDP20AFOHT	GSWDPN20AFOHT	GSPURHT	GSWSPURHT	GSWNSPURHT
Microwave						GSWSPURMW	GSWNSPURMW
Oven	GSWDP20AOV	GSWDPN20AOV					
Security						GSPURSS	
Towel rail			GSWDP20AFOTR	GSWDPN20AFOTR		GSPURTR	
Tumble dryer						GSPURTD	GSWNSPURTD
Washer dryer						GSPURWDY	GSWNSPURWDY
Waste disposal						GSPURWD	GSWNSPURWD
Washing machine						GSPURWM	GSWNSPURWM



G45ACCUN

45A DP switches and cooker controls

- Dimensions: 86 x 86mm (1 gang), 86 x 146mm (2 gang)
- Mounting box:
 - SB471 (F) 1 gang GPAT1G47 (S)
 - SB472 (F) 2 gang GPAT2G47 (S)
- Fix screws: M3.5 x 30mm
- BS 4177
- BS 5733
- BS EN 60669-1

Part number	Description	Qty
GCKR45A	45A DP 1 gang	5
GCKRN45A	45A DP 1 gang with neon	5
GCKR45A2G	45A DP 2 gang	5
GCKRN45A2G	45A DP 2 gang with neon	5
G45ACCU	45A Cooker control unit with 13A socket	1
G45ACCUN	45A Cooker control unit with 13A socket and neon	1
G45CX	45A connection unit	10



GSHVSKT

Shaver socket

- Dimensions: 146 x 86mm
- Mounting box: SB472 (F) GPAT2G47 (S)
- Fix screws: M3.5 x 30mm
- BS EN 61558-2-5

Part number	Description	Qty
GSHVSKT	Shaver socket with dual 115/230V output	1
GADAPTSVR	Shaver adaptor 1A fuse (fuse to BS 646)	20



GSKTCOAX2G

Communication outlets

- Dimensions: 86 x 86mm
- Mounting box: SB251 (F) GPAT1G25 (S)
- Fix screws: M3.5 x 30mm
- BS EN 41003
- BS 3041 (where applicable)

Part number	Description	Qty
GTELMAS	Single telephone master	10
GTELSEC	Single telephone secondary	10
GSKTCOAX	Single direct connection TV	10
GSKTCOAX2G	Twin direct connection TV	10



GTEL/RJ11

Data outlets

- Dimensions: 86 x 86mm
- Mounting box: SB251 (F) GPAT1G25 (S)
- Fix screws: M3.5 x 30mm
- BS EN 41003

Part number	Description	Qty
GTELRJ11	RJ11 outlet	10
GTELRJ45	RJ45 outlet	10



GBLANK2G

Blank plates & replacement screws

- Dimensions: 86 x 86mm (1 gang), 86 x 146mm (2 gang)
- Fix screws: M3.5 x 30mm
- BS 5733

Part number	Description	Qty
GBLANK1G	1 gang blank plate	10
GBLANK2G	2 gang blank plate	5



GUE7010W



GUE7030W



GUE7061W

Euro modules

- Dimensions: 25 x 50mm (single), 50 x 50mm (double)
- Mounting box:
 - 1 module: SB251 (F) 1 gang
SB252 (F) 2 gang
 - 2 module: SB351 (F) 1 gang
SB352 (F) 2 gang

Part number	Description	Module size	Qty
GUE7010W	TV/Radio diplexer	2	1
GUE7011W	Single IEC coax (female)	1	1
GUE7012W	Single IEC coax (male)	1	1
GUE7030W	Single F type sat	1	1
GUE7040W	TV/Sat diplexer	2	1
GUE7081W	TV/FM/Sat triplexer	2	1
GUE7082W	TV/FM/Sat 1/Sat 2 quadplexer	2	1
GUE7020W	HDMI	2	1
GUE7051W	RJ11 modem	1	1
GUE7061W	Telephone (BT master)	1	1
GUE7062W	Telephone (BT secondary)	1	1
GUE7071W	RJ45 CAT5e (not screened)	1	1
GUE7072W	RJ45 CAT6 (not screened)	1	1
GUE7075W	VGA	1	1
GUE7091W	LexCom Performance outlet	1	8
GUE7000W	2 x Phono socket	1	1
GUE7001W	2 x Loudspeaker socket	1	1
GUE8010W	Blank module	1	5

Surface pattress boxes

- All moulded pattresses are supplied with earth terminal
- BS 5733



GPAT1G16



GPAT2G25

Part number	Description	Qty
GPAT1G16	1 gang 16mm deep	10
GPAT1G25	1 gang 25mm deep	10
GPAT2G25	2 gang 25mm deep	5
GPATDG25	Dual 25mm deep	10
GPAT1G47	1 gang 47mm deep	10
GPAT2G47	2 gang 47mm deep	5
GPAT1G16A	1 gang architrave 16mm deep	20
GPAT2G16A	2 gang architrave 16mm deep	10

Converter pattresses

- GPAT3G25 is for use with GSKTSW3G, see Exclusive moulded section



GPAT2GC25

Part number	Description	Qty
GPAT2GC25	1-2 gang 25mm deep	5
GPAT3G25	1-3 gang 25mm deep	5

Exclusive decorative

The Exclusive decorative metal plate range is designed to suit domestic interiors and commercial applications and offers an extensive range of accessories.

The range is available in either Matt Chrome or Polished Chrome finishes, both with white interiors.

Features & benefits:

- > Comprehensive range to complete any installation requirement
- > High quality Exclusive interiors used throughout
- > Timeless traditional plate profile suitable for both domestic and commercial use
- > Plate profiles match across the entire range
- > Includes a range of traditional style surface switches



GEP3520WPC

13A socket outlets

- Dimensions: 95 x 95mm (1 gang), 95 x 154.5mm (2 gang)
- Mounting box:
 - SB251 (F) 1 gang
 - SB252 (F) 2 gang
- Fix screws: M3.5 x 30mm
- BS 1363

Part number	Description	Qty
GEP3550***	1 gang unswitched	1
GEP3560***	2 gang unswitched	1
GEP3510***	1 gang switched	1
GEP3520***	2 gang switched	1
GEP3580***	1 gang 5A round pin unswitched	1



GEP1532WMC

6AX plate switches

- Dimensions: 95 x 95mm (1 - 3 gang), 95 x 154.5mm (4 gang)
- Mounting box:
 - SB161 (F) 1 - 2 gang
 - SB251 (F) 3 gang
 - SB252 (F) 4 gang
- Fix screws: M3.5 x 25mm
- BS EN 60669-1
- BS EN 60947-3 (GEP1513***)

Part number	Description	Qty
GEP1512***	1 gang 2 way	1
GEP1522***	2 gang 2 way	1
GEP1532***	3 gang 2 way	1
GEP1542***	4 gang 2 way	1
GEP1513***	3 pole isolator	1
GEP1514***	1 gang intermediate	1
GEP1512T**	1 gang 2 way toggle	1
GEP1522T**	2 gang 2 way toggle	1



GEP6512PC

Note
Mains dimmer switches are not suitable on low voltage circuits. See technical section

Mains dimmer switches

- Dimensions: 95 x 95mm (1 - 2 gang)
- Mounting box: SB251 (F) 1 - 2 gang
- Fix screws: M3.5 x 30mm
- BS EN 60669-2-1

Part number	Description	Qty
GEP6512**	1 gang 2 way 400W	1
GEP6522**	2 gang 2 way 250W	1



GEP6512LVPC

Low voltage dimmer switches

- Dimensions: 95 x 95mm (1 - 2 gang), 95 x 154.5mm (3 - 4 gang)
- Mounting box:
 - SB251 (F) 1 - 2 gang
 - SB252 (F) 3 - 4 gang
- Fix screws: M3.5 x 30mm
- BS EN 60669-2-1

Part number	Description	Qty
GEP6512LV**	1 gang 2 way 400VA LV	1
GEP6522LV**	2 gang 2 way 250VA LV	1
GEP6532LV**	3 gang 2 way 250VA LV	1
GEP6542LV**	4 gang 2 way 250VA LV	1

Note Replace *** with suffix code to denote finish/interior colour required:

Note Replace ** with suffix code to denote finish required:

WMC Matt chrome with white interior

WPC Polished chrome with white interior



GEP2511WMC

20A DP switches

- Dimensions: 95 x 95mm
- Mounting box: SB251 (F)
- Fix screws: M3.5 x 30mm
- BS EN 60669-1

Part number	Description	Qty
GEP2510***	DP switch	1
GEP2511***	DP switch with neon	1



GEP5511WMC

13A fused connection units

- Dimensions: 95 x 95mm
- Mounting box: SB251 (F) 1 gang
- Fix screws: M3.5 x 30mm
- BS 1363

Part number	Description	Qty
GEP5500***	Unswitched	1
GEP5501***	Unswitched with neon	1
GEP5510***	Switched	1
GEP5511***	Switched with neon	1



GEP4521WPC

45A DP switches

- Dimensions: 95 x 95mm
- Mounting box: SB471 (F)
- Fix screws: M3.5 x 30mm
- BS EN 60669-1

Part number	Description	Qty
GEP4520***	DP switch	1
GEP4521***	DP switch with neon	1



GEP4501WPC

45A cooker control unit

- Dimensions: 95 x 154.5mm
- Mounting box: SB472 (F)
- Fix screws: M3.5 x 30mm
- BS 4177

Part number	Description	Qty
GEP4501***	45A DP cooker connection unit with neon	1



GEP7590WPC

Shaver socket

- Dimensions: 154.5 x 95mm
- Mounting box: SB472 (F)
- Fix screws: M3.5 x 30mm
- BS EN 61558-2-5

Part number	Description	Qty
GEP7590***	115/230V dual voltage	1



GEP7561WPC

Communication outlets

- Dimensions: 95 x 95mm
- Mounting box: SB251 (F)
- Fix screws: M3.5 x 30mm
- BS EN 41003

Part number	Description	Qty
GEP7561***	Master telephone outlet	1
GEP7562***	Secondary telephone outlet	1

Note Replace *** with suffix code to denote finish/interior colour required:
WMC Matt chrome with white interior **WPC** Polished chrome with white interior



GEP7510WPC

TV socket outlets

- Dimensions: 95 x 95mm
- Mounting box: SB351 (F)
- Fix screws: M3.5 x 30mm
- BS 3041 (where applicable)

Part number	Description	Qty
GEP7510***	Single TV/FM coaxial	1
GEP7521**	Diplex outlet	1
GEP7581**	Triplex outlet	1



GEP8510PC

Blank plates

- Dimensions: 95 x 95mm (1 gang), 95 x 154.5mm (2 gang)
- Fix screws: M3.5 x 30mm
- BS 5733

Part number	Description	Qty
GEP8510**	1 gang blank plate	1
GEP8520**	2 gang blank plate	1



363WE

10A traditional style surface switches

Part number	Description	Qty
363BR	10A 2 way surface switch - Brown	1
363WE	10A 2 way surface switch - White	1
360WE	DP foot switch - White	5
360BK	DP foot switch - Black	5



E192030WE

10A traditional dolly style switches

Part number	Description	Qty
E192030WE	1 gang SP 250V Brass - White Base	1
E192030BK	1 gang SP 250V Brass - Black Base	1
E192030MIBK	1 gang SP 250V Brass Intermediate - Black Base	1
E1920R30WE	Ribbed 1 gang SP 250V 2 way Brass - White Base	1
E1920R30MIWE	Ribbed 1 gang SP 250V Intermediate Brass - White Base	1



E1920MB2PN

Mounting blocks

Part number	Description	Qty
E1920MBR1PN	1920 mounting block 1 gang round - Pine	1
E1920MB1PN	1920 mounting block 1 gang square - Pine	1
E1920MB2PN	1920 mounting block 2 gang - Pine	1

Note Replace *** with suffix code to denote finish/interior colour required:

Note Replace ** with suffix code to denote finish required:

WMC Matt chrome with white interior

WPC Polished chrome with white interior

Exclusive metal clad

Our Exclusive metal clad range has been built to perform. The strong, industrial design supported by a robust technical specification makes this range the perfect choice for a variety of commercial and public buildings.

Popular trends in the domestic market for modern loft style interiors also provide the perfect backdrop for this range which is available in either grey or silver grey finishes.

Features & benefits:

Consumer

- > Comprehensive range
- > Tough and impact resistant
- > Choice of grey and silver grey finishes ideal for commercial spaces and modern domestic interiors

Installer

- > Easy to install
- > All products are supplied complete with 42mm deep surface mounting box in matching finish
- > Boxes are supplied with a full selection of 20mm knockouts
- > 1 – 24 gang grid cover plates available



GMC131SS

13A socket outlets

- Dimensions: 79 x 79 x 42mm (1 gang), 79 x 139 x 42mm (2 gang)
- BS 1363

Part number	Description	Qty
Grey	Silver grey	
GMC131S	GMCS131S	1 gang unswitched
GMC132S	GMCS132S	2 gang unswitched
GMC131SS	GMCS131SS	1 gang switched
GMC132SS	GMCS132SS	2 gang switched
GMC51S	GMCS51S	5A round pin unswitched

13A DP outboard rocker switched socket outlet

- Dimensions: 79 x 139 x 42mm
- BS 1363

Part number	Description	Qty
GU3631GMC	2 gang switched with clean earth	1

RCD protected devices

- Dimensions: 92 x 145 x 49mm
- Electronic latch - active control
- Mechanical latch - passive control
- Passive devices do not require resetting in the event of power failure
- BS 7288



LMCSKT2GR

Part number	Description	Qty
LMCSKT1GR	1 gang RCD 30mA active control	1
LMCSKT2GR	2 gang RCD 30mA active control	1
LMCSKT2GRP	2 gang RCD 30mA passive control	1
GMCPRCDSKT1G	1 gang switched RCD 30mA passive	1
GMCPRCDFCU	1 gang fused connection unit RCD 30mA passive	1

6AX plate switches

- Dimensions: 79 x 79 x 42mm
- BS EN 60669-1



GMC612

Part number	Description	Qty
Grey	Silver grey	
GMC612	GMCS612	1 gang 2 way
GMC622	GMCS622	2 gang 2 way
GMC632	GMCS632	3 gang 2 way
GMCINT	GMCSINT	1 gang intermediate



GMC20SN

20A DP switches

- Dimensions: 79 x 79 x 42mm
- BS EN 60669-1

Part number	Grey	Silver grey	Description	Qty
GMC20S		GMCS20S	20A DP	10
GMC20SN		GMCS20SN	20A DP with neon	10



GMC45S

45A switches

- Dimensions: 79 x 79 x 42mm (1 gang), 139 x 79 x 42mm (2 gang)
- BS EN 60669-1

Part number	Grey	Silver grey	Description	Qty
GMC45S		GMCS45S	1 gang DP	10
GMC45SN		GMCS45SN	1 gang DP with neon	10
GMC45S2N		GMCS45S2N	2 gang DP with neon	5



GMC13SSP

13A fused connection units

- Dimensions: 79 x 79 x 42mm
- BS 1363

Part number	Grey	Silver grey	Description	Qty
GMC13SP		GMCS13SP	Unswitched	10
GMC13SPN		GMCS13SPN	Unswitched with neon	10
GMC13SPF		GMCS13SPF	Unswitched with flex outlet	10
GMC13SPNF		GMCS13SPNF	Unswitched with neon and flex outlet	10
GMC13SSP		GMCS13SSP	DP switched	10
GMC13SSPN		GMCS13SSPN	DP switched with neon	10
GMC13SSPF		GMCS13SSPF	DP switched with f/outlet	10
GMC13SSPNF		GMCS13SSPNF	DP switched with neon and flex outlet	10



GMCB1

Blank plates

- Dimensions: 79 x 79 x 42mm (1 gang), 79 x 139 x 42mm (2 gang)
- BS 5733
- Blank plate supplied with surface mounting box

Part number	Grey	Silver grey	Description	Qty
GMCB1		GMCSB1	1 gang blank plate	10
GMCB2		GMCSB2	2 gang blank plate	5

Note: All products except grid plates are supplied complete with 42mm depth surface mounting box in matching finish. 1 gang box includes 4 x 20mm knockouts, 2 gang box includes 10 x 20mm knockouts



GUG03GSMC

Surface metal clad grid plates

- BS 5733
- Supplied with mounting grid
- See grid section for switch modules

Part number		Description	Qty
Grey	Silver		
GUG01GMC	GUG01GSMC	1 module	1
GUG02GMC	GUG02GSMC	2 module	1
GUG03GMC	GUG03GSMC	3 module	1
GUG04GMC	GUG04GSMC	4 module	1
GUG06GMC	GUG06GSMC	6 module	1
GUG08GMC	GUG08GSMC	8 module	1
GUG09GMC	GUG09GSMC	9 module	1
GUG12GMC	GUG12GSMC	12 module	1
GUG18GMC	GUG18GSMC	18 module	1
GUG24GMC	GUG24GSMC	24 module	1



GBG01

Surface mounting boxes (for grid plates)

- All boxes are supplied with 25mm knockouts and earth terminals
- BS 5733

Part number		Description	Qty
Grey	Silver		
GBG01	GBGS01	1-2 gang mounting box	10
GBG02	GBGS02	3-4 gang mounting box	5
GBG03	GBGS03	6-8 gang mounting box	1
GBG04S	GBGS04S	9-12 gang mounting box	1
GBG06S	GBGS06S	18-24 gang mounting box	1

Note: All products except grid plates are supplied complete with 42mm depth surface mounting box in matching finish. 1 gang box includes 4 x 20mm knockouts, 2 gang box includes 10 x 20mm knockouts

E-Series polycarbonate

The E-Series range of wiring accessories is made of high impact resistant polycarbonate components. Besides incorporating a modular design and multi-gang capability, it consists of flush plates that are further enhanced with specially designed screw caps that conceal all mounting screws.

E-Series switches and sockets are tough, resilient, built to take hard knocks and guaranteed to provide exceptional product life.

Features & benefits:

- > Comprehensive product offer
- > Virtually indestructible front plates
- > Any mechanism can be fitted to switch plates
- > UV stable
- > Outboard rockers as standard



E426WE

13A unswitched socket outlets

■ BS 1363

Part number	Description	Qty
E426WE	1 gang 3 pin socket outlet	1



E15WE

13A SP switched socket outlets with outboard rockers (2 gang)

■ BS 1363

Part number	Description	Qty
E15WE	1 gang 3 pin switched socket outlet	1
E15NWE	1 gang 3 pin switched socket outlet with neon	1
E25WE	2 gang 3 pin switched socket outlet	1
E25NWE	2 gang 3 pin switched socket outlet with neon	1



E15NWE

13A DP switched socket outlets

■ BS 1363

Part number	Description	Qty
E15DWE	1 gang DP switched socket	1

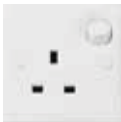

E15DWE

13A DP switched sockets with 'HI' earth and outboard rockers

■ BS 1363

Part number	Description	Qty
E25DWE	2 gang DP switched with high integrity earth	1



E25DWE

13A clean earth socket outlets with outboard rockers

■ BS 1363

Part number	Description	Qty
E25CESFNWE	2 gang clean earth filtered switched socket outlet with surge protection and neon	1



E25CESFNWE

13A surge protected switched socket outlets with outboard rockers

■ BS 1363

Part number	Description	Qty
E25SFWE	2 gang switched socket with surge protection	1
E25CESFWE	2 gang switched socket with surge protection and filtered clean earth	1



E25SFWE

5A round pin unswitched socket outlets

■ BS 546

Part number	Description	Qty
E4265WE	1 gang 3 pin socket outlet	1



E4265WE

15A round pin switched socket outlets

■ BS 546

Part number	Description	Qty
E1515WE	1 gang 3 pin switched socket outlet white	1



E1515WE



E31WP23SAWE

IP54 wall switch

■ BS 5733

Part number	Description	Qty
E31WP23SAWE	1 gang 2 way switch IP54	1
E31WPWE	Wall plate to accept mechanisms	1



E30T6AWE

6A TP fan isolator

■ BS EN 60947-3

Part number	Description	Qty
E30T6A	250V TP fan isolator	1



E319WE

Time delay switch

- Adjustable up to 20 minutes
- Can be used in 2 way circuits
- Suitable for staircases and corridors
- IEC 60669-2-1



Part number	Description	Qty
E319WE	10A 1 gang pneumatic	1



30WE

10A architrave switches

■ BS EN 60669-1

Part number	Description	Qty
30WE	1 gang 2 way	1



E311SAWE

10A wall switches

■ BS EN60669-1

Part number	Description	Qty
E311SAWE	1 gang 1 way	1
E312SAWE	1 gang 2 way	1
E311AWE	1 gang intermediate	1
E322SAWE	2 gang 2 way 3 terminal	1
E332SAWE	3 gang 2 way 3 terminal	1
E342SAWE	4 gang 2 way	1



E342SAWE



E31RD400WE

Rotary dimmer

■ BS EN 60669-2

Part number	Description	Qty
E31RD400WE	240V 400W 1 gang 1 way dimmer	1





E32D20NGEWE



E30FSGWE



E31DFSGNWE



ED45NWE



ED4513NWE

20A DP flush switches

■ BS EN 60669-1

Part number	Description	Qty
E31D20GEWE	1 gang DP	1
E32D20NGEWE	DP with neon & bottom cable outlet	1

13A fused connection units

■ BS 1363

Part number	Description	Qty
E30FSGWE	Unswitched	1
E30FSGNWE	Unswitched with neon indicator	1
E31DFSGWE	Switched	1
E31DFSGNWE	Switched with neon indicator	1

25A flex outlet plate

■ BS 5733

Part number	Description	Qty
E31TBWE	1 gang connection unit	1

45A DP switches

■ BS EN 60669-1

Part number	Description	Qty
ED45WE	DP switch	1
ED45NWE	DP switch with neon	1

45A cooker control units

■ BS 4177

Part number	Description	Qty
ED4513NWE	DP switch & 13A switched socket outlet with neon indicator	1



E727WE

Universal shaver socket outlet

■ BS EN 61558-2-5

Part number	Description	Qty
E727WE	115V 240V shaver unit	1



E34061MWE

Telephone outlets

■ BS EN 41003

Part number	Description	Qty
E34061MWE	Single master telephone	1
E34061SWE	Single secondary telephone	1
ET01E	US style telephone	1



E32TV75WE

TV outlets

■ BS 3041

Part number	Description	Qty
E31TV75WE	Single co-axial	1
E32TV75WE	Twin co-axial	1
E31TVFWE	Single 'F' type satellite connector	1



E31XWE

Blank plates

■ BS 5733

Part number	Description	Qty
E31XWE	1 gang blank flush plate	1
E312XWE	2 gang blank flush plate	1



ET238WE

Surface patresses

■ BS 1363

Part number	Description	Qty
701WE	1 gang architrave	1
E238WE	1 gang 35mm	1
ET238WE	2 gang 35mm	1

13A switched Converta socket outlets

- Polycarbonate construction providing high levels of impact resistance
- Double pole isolation on 2 into 3 version only
- High integrity earthing as standard
- BS 1363

Part number	Description	Qty
E251WE	1 into 2 switched	1
E251BP	1 into 2 switched blister packed	1
E25DF32WE	2 into 3 switched	1
E25DF32BP	2 into 3 switched blister packed	1



1 to 2 gang



2 to 3 gang



Converta wiring accessories are an ideal retrofit component for existing installations. They allow single to double, or double to triple conversion of standard flush-mounted wiring accessories without the need for additional cabling or chasing.

- Private or public sector, domestic or commercial applications
- Allows 2 gang socket to fit on 1 gang box or 3 gang socket to fit on 2 gang box
- Quick and easy replacement
- Saves time and money
- Reduces the need for redecorating
- Virtually indestructible polycarbonate front plate
- Dual earth for easy installation



E-Series polycarbonate plates & mechanisms

E-Series mechanisms are designed to international safety standards and are available in single or double pole versions. These mechanisms provide greater installation flexibility.

Features & benefits:

- > The wide choice of mechanisms fit E-Series plates
- > Mechanisms clip into front plates for fast installation
- > Any combination possible to tailor bespoke requirements
- > Rockers are manufactured from virtually indestructible polycarbonate
- > Printing service available on request
- > Blank plugs are available for unused apertures



E32WE

Wall plates

■ BS 5733

Part number	Description	Qty
E31WE	1 gang flush plate	1
E32WE	2 gang flush plate	1
E33WE	3 gang flush plate	1
E34WE	4 gang flush plate	1
E35WE	5 gang flush plate	1
ET36WE	6 gang flush plate	1
32WE	2 gang architrave plate	1



301SMWE



30MD20WE

Switch mechanisms

■ BS 60669-1

Part number	Description	Qty
301SMWE	10A 1 way 2 terminal	1
302SMWE	10A 2 way 3 terminal	1
30MIWE	10A intermediate switch module	1
39MWE	10A 4 terminal 3 position 'LO-OFF-HI'	1
30FLM15WE	15A switch mechanism (For fluorescent loads only)	1
30M20WE	20A 2 way 4 terminal	1
30MD20WE	20A DP	1
30TKMWE	20A 2 way toggle key actuated	1
30M35WE	35A 2 way 4 terminal	1



30MBPNWE

Bell push mechanisms

■ BS 60669-1

Part number	Description	Qty
30MBPWE	15A 440V bell push button - White	1
30MBPNWE	15A 250V push button with neon - White	1
30MBPRWE	10A bell press button marked 'PRESS' - White	1



30NRD

Neon indicator, light mechanisms, fuse units and surge protection

■ BS 5733
■ BS 5518
■ BS 1363

Part number	Description	Qty
30NRD	250V neon indicator - Red	1
30NGR	250V neon indicator - Green	1
32E450LMWE	400VA dimmer to suit low voltage transformer - White	1
32E450TMWE	400VA dimmer to suit low voltage transformer trailing edge - White	1
30FSWE	13A fuse carrier - White	1
30SFMOP	Surge Filter	1



30RJ45SMA5SHWE

TV & data outlets

Part number	Description	Qty
30RJ45SMA5SHWE	Cat 5 mechanism with shutter - White	1
30TV75MSWE	75 ohm crimp type - screw fixed TV antenna socket	1
30PFMWE	F type satellite connector - white	1



9WE

Screw and caps

Part number	Description	Qty
31J	Security screws for mechanisms	10
9WE	Plain screw caps - White	10
30PWE	Moulded removable plugs - plain	1

T2 ceiling accessories

The highly successful T2 ceiling accessories range maintains superb quality and easy to install technical specification that has established this design as a firm favourite.

The range includes polycarbonate and safety ceiling accessories. When safety is of the utmost importance the range of safety ceiling accessories from Schneider Electric ensures the supply is completely disconnected until a lamp is fully inserted. Thus the risk of electric shock is minimised, with full double pole switching.

Features & benefits:

- > Fully coordinated fully rated T2 range incorporates large footprint for easy installation together with raised mounting feet to assist installation on uneven surfaces
- > Ample wiring space with four knockouts
- > Clear terminals for easy visibility and installation
- > Batten holders and ceiling roses share a common base assembly with 50.8mm fixing centres
- > Pendant lamp holder has integral cord grip to prevent cable pull on terminals
- > The range includes polycarbonate and lamp activated lampholders
- > Full range of accessories including dry lining and conduit boxes



GABAT

Batten lampholder

- Clear terminals for easy visibility and installation
- Ample wiring space with four knockouts
- Large capacity earth terminal
- Pendant lamp holder has integral cord grip to prevent cable pull on terminals
- Batten lamp holders (straight and angled) are pre-wired
- BS EN 61184

Part number	Description	Qty
GBAT	Pre-wired batten-lampholder	10
GBATC	Pre-wired clear base batten-lampholder	10
GABAT	Pre-wired angled batten-lampholder	10
GABATC	Pre-wired clear base angled batten-lamp holder	10



GEBAT

Fixed terminal batten holder & ceiling rose

- Raised mounting feet assist mounting on uneven surfaces
- Batten holders and ceiling roses share a common base assembly. Fixing centres are 50.8mm
- Bases also include easy joist mounting facility
- BS EN 61184
- BS 67

Part number	Description	Qty
GEBAT	T2 batten holder 3 terminal	10
GRO	Ceiling rose	10
GROC	Clear base ceiling rose	10



GPEND6

Pendants & lampholder

- High heat resistance (T2 rated) to BS EN 61184:1995. (Batten holders & lamp holders only)
- Max lamp rating 150W
- Plunger springs are enclosed in brass sleeves
- Zinc plated steel bayonet sleeve for durability
- BS EN 60598-2-1
- BS EN 61184

Part number	Description	Qty
GPEND6	Pre-wired 6" pendant	10
GPEND6C	Pre-wired 6" clear base pendant	10
GPEND9	Pre-wired 9" pendant	10
GPEND9C	Pre-wired 9" clear base pendant	10
GLHC	Lampholder with integral cord grip	20



Energy saving pendant



- Complies with Part L of the building regulations
- Build properties must have a fixed proportion of lighting points suitable for compact fluorescent lamps only
- Requires 1 x 13W 4 pin compact fluorescent lamp (not supplied) or 1 x 18W 4 pin compact fluorescent lamp (not supplied)

Part number	Description	Qty
GESPEND613	13W Energy saving pendant with 6" flex	1
GESPEND618	18W Energy saving pendant with 6" flex	1



E93PS6WE

Polycarbonate ceiling accessories

Part number	Description	Qty
E93PS6WE	Pendant set, 6 inch, white	1
E93PS9WE	Pendant set, 9 inch, white	1
E93WE	Ceiling rose, white	1
E94WE	Batten holder, white	1
E501SSWE	Lamp holder, short skirt	1



GBATS

Safety ceiling accessories

- T2 Rated
- Mains supply is disconnected until lamp is fully inserted.
- DP switching mechanism for complete isolation
- Terminals can only be accessed via tool
- BS EN 61184
- BS 7895

Part number	Description	Qty
GBATS	Pre-wired safety batten lamp holder	10
GPEND6S	6" safety pendant lamp holder	10
GLHCS	Safety lamp holder with integral cord grip	10



GSWPULL45N

Ceiling switches

- All items have 1.5m white nylon cord
- GSWPULL6 and GSWPULL62 fit BESA boxes with standard 50.8mm centre distances between the fixings
- Fully rated at 6AX for fluorescent or inductive loads
- 45A suitable for use as an isolator switch
- BS EN 60669-1

Part number	Description	Qty
GSWPULL6	6AX 1 way	10
GSWPULL62	6AX 2 way	10
GSWPULL45	45A double pole 1 way	10
GSWPULL45N	45A double pole 1 way with neon	10



GJB620A



GJB5ABR

Junction boxes (white or brown)

- Dimensions: 5A & 20A – Ø74mm, 30A – Ø85mm
- Terminal capacity: 5A 4 x 1.5mm², 20A 2 x 2.5mm², 30A 4 x 4mm²
- BS EN 60670-22

Part number	Description	Qty
GJB5ABR	5A 4 terminal selective entry 4 x 1.5mm	10
GJB20ABR	20A 4 terminal selective entry 3 x 2.5mm	10
GJBN20ABR	20A 4 terminal non-selective entry 3 x 2.5mm	10
GJB620ABR	20A 6 terminal selective entry x 2.5mm	10
GJB30ABR	30A 3 terminal selective entry x 4mm	10
GJBN20ASBR	Compact 20A 4 terminal non-selective entry 59mm diameter	10



25mm deep breakaway boxes

- Material: uPVC
- Colour: white
- BS 4662
- All boxes can be used with both standard and coiled miniature trunking
- Note: Please see details relating to thermal expansion

Part number	Description	Qty
MMB251W	1 gang	10
MMB252W	2 gang	10
MMB252SW	2 gang side entry	10

Standard boxes accept 16 x 16mm and 25 x 16mm mini.
Reducer kits for other sizes available on request.

Deep boxes with mini entries

Part number	Description	Qty
Rounded corners		
TBR321W	1 gang	10
TBR322W	2 gang	10

Square corners

TBU321W	1 gang	10
TBU322W	2 gang	10
TBU441W	1 gang	10



Mini entry adapters

For use with TBU and TBR boxes

Part number	Description	Qty
MTAU1W	16 x 16mm	10
MTAU2W	25 x 16mm	10
MTAU3W	38 x 16mm	10



Ceiling rose box

Part number	Description	Qty
CRA12W	16 x 16mm to 25 x 16mm entries, fixing centre 50.8mm Overall diameter 82mm, depth 13.5mm	25



Conduit boxes - square corners

Part number	Description	Qty
KBS252W	2 gang knockout 25mm deep	10
KBU321W	1 gang knockout 32mm deep	
KBU322W	2 gang knockout 32mm deep	
PBU441W	Plain 44mm deep	
KBU441W	Knockout 44mm deep	

Note: Square cornered boxes still have infill corners to take round corner plates if required



Conduit boxes - round corners

Part number	Description	Qty
KBR251W	1 gang knockout 25mm deep	20
PBR332W	2 gang plain 32mm deep	
KBR321W	1 gang knockout 32mm deep	
KBR322W	2 gang knockout 32mm deep	



Circular dry lining box

- Quick and simple to install
- Suitable for pendant drops, smoke alarms etc
- Maximum weight support is 3kg at 60°C
- 2 knockouts - both 20mm
- Overall diameter 67mm
- M3.5 x 30mm required

Part number	Description	Qty
CRB2W	50.8mm fixing centre	10



GDL1

Dry lining boxes

- Can be installed on thin wall section
- Ideal for plasterboard
- Minimum and maximum thickness 2 - 17mm
- BS 5733

Part number	Description	Qty
GDL1	1 gang 34mm deep	10
GDL2	2 gang 34mm deep	10



SB161

Flush galvanised steel boxes

- All galvanised steel accessory boxes are supplied with earth terminal and screw
- Supplied with fixed and adjustable lugs
- Fitted with selection of 20mm knockouts in sides and back of boxes
- BS 4662

Part number	Description	Qty
SB161	1 gang 16mm deep	20
SB251	1 gang 25mm deep	10
SB252	2 gang 25mm deep	10
SB351	1 gang 35mm deep	10
SB352	2 gang 35mm deep	5
SB471	1 gang 47mm deep	10
SB472	2 gang 47mm deep	4



TOP13A

Plugs & adaptors

- BS 1363 (13A plugs)
- Uses fuse to BS 1361
- BS 546 (round pin plugs)
- Round pin plugs unfused

Part number	Description	Qty
TOP2AR	2A round pin plug	20
TOP5AR	5A round pin plug	20
TOP15AR	15A round pin plug	20
TOP133A	Plug top fitted with 3A fuse	20
TOP13A	Plug top fitted with 13A fuse	20
ADAPT2W	2 way unfused adaptor	10
ADAPT3WF	3 way fused adaptor	10
400112	3A BS1362 fuses, 4 pack	1
400113	5A BS1362 fuses, 4 pack	1
400114	13A BS1362 fuses, 4 pack	1

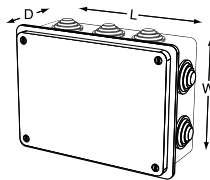

Moulded enclosures

Dimensions (LxWxD)mm	Size code
- 80 x 40mm	1
- 80 x 80 x 40mm	2
- 100 x 100 x 50mm	3
- 120 x 80 x 50mm	4
- 150 x 110 x 70mm	5
- 190 x 140 x 70mm	6
- 240 x 190 x 90mm	7
- 300 x 220 x 120mm	8
- 380 x 300 x 120mm	9

Part number	Size code	No. of entries	Qty
Plain - IP56			
GE115P	3	6	1
GE125P	4	6	1
GE157P	5	10	1
GE197P	6	10	1
GE249P	7	12	1
GE321P*	8	12	1
GE381P*	9	12	1
Stepped glands - IP56			
GE84S**	1	4	1
GE884S**	2	6	1
GE115S	3	6	1

* Hinged lid
 ** IP44 rating



Internal back plates

Part number	Size code	Qty
GEBP6	6	1
GEBP7	7	1
GEBP8	8	1
GEBP9	9	1

Occupancy sensors

By leveraging state of the art infra-red, and combined ultrasonic and infrared (dual technologies), our ultra sensitive occupancy sensors offer you the ultimate in reliable, efficient and cost effective lighting control.

This provides a quick and environmentally friendly way of reducing energy consumption with easy setup. Compared to a traditional manual switch, there are significant potential energy savings that can be achieved by utilising occupancy sensors.

The Schneider Electric occupancy sensor range, combines a selection of outdoor passive infra-red devices, and indoor ceiling or wall mountable devices.

Features & benefits:

- > Delivers measurable energy savings
- > Combines infra-red and ultrasonic detection technologies
- > Simple programming by infra-red remote controller
- > Dual loading
- > Suitable for different lighting loads (incandescent, AC halogen, LV halogen, fluorescent)
- > Complementary to the Ultimate screwless flat plate range of wiring accessories

Ceiling mounted sensors



- Surface or flush mount (SAEUEMSCDBWE flush mount only)
- 7m at 2.5m height range (SAEUEMSCUWE 12m x 18m at 2.5m height range)



SAEUEMSCUWE

Part number	Description	Qty
SAEUEMSCUWE	Single-load 360° PIR and ultrasonic sensor	1
SAEUEMSIR10T	IR Remote for SAEUEMSCUWE	1
SAEUEMSCSAWE	Single-load 360° PIR sensor	1
SAEUEMSCDBWE	Dual-load 360° PIR sensor	1

- Surface mount
- Detection area 6m x 6m at 2.4m height range



E751

Part number	Description	Qty
E751	Infrascan single-load 2A 120° PIR sensor	5
E751R	Infrascan single-load 10A 120° PIR sensor	5

Field of view:

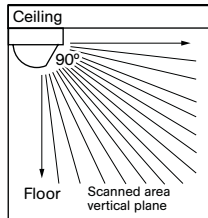

90° viewing angle

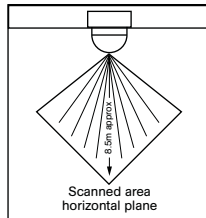

Detection area 6 x 6 metres

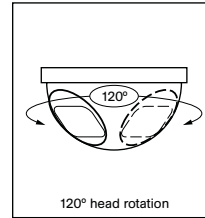

120° head rotation

Wall mounted PIR plate switch



- Field of view: 90°
- Range: 5m at 1.2m height
- Time setting: 15sec - 30min
- Stainless Steel finish with black interior



GUPA1411BSS

Part number	Description	Qty
GUPA1411BSS	1 gang 1 way PIR plate switch with override	1
GUP1411BSS	1 gang 1 way PIR plate switch	1



Outdoor PIR detectors



CCT56P008

- Detection field up to 18 metres
- Includes separate mounting base
- Base includes conduit entries
- Suitable for wall or ceiling mounting

Part number	Description	Qty
CCT56P004	Single-load PIR 120° detector	1
CCT56P008	Single-load PIR 360° detector	1
E750WPRGY	Infrascan single-load PIR 110° detector	5



E750WPRGY

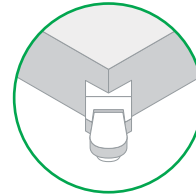
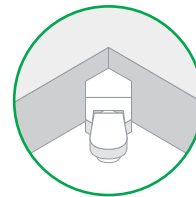
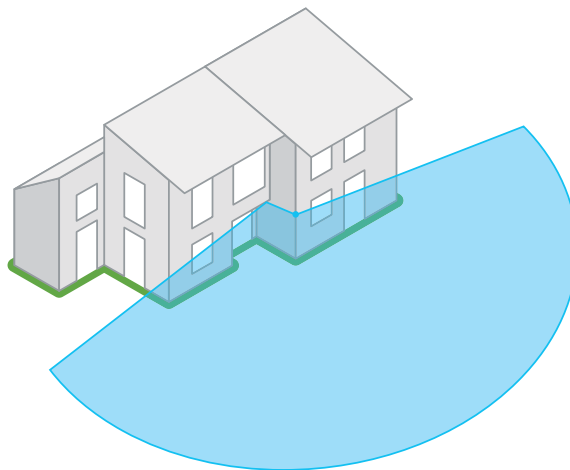
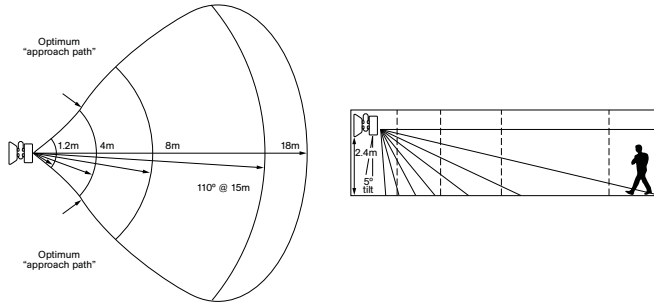



Weatherproof

IP66 & IP55

Our weatherproof range are tough, durable options for outdoor or more arduous environments. Socket outlets are IP66 or IP55 rated for even greater weather resistance.

The smooth, curved design also delivers on aesthetic appeal whilst providing a high performance application. The range is available as 1 to 3-gang switches, 20AX switches and 1 to 2-gang sockets, together with an RCD protected 2-gang socket outlet for essential personal protection.



Features & benefits:

Consumer

- > Smooth, curved aesthetic design
- > Manufactured from tough, durable thermoplastic
- > IP66 for maximum weatherproof protection whilst in use
- > IP55 for general outdoor weatherproof protection

Installer

- > Standard knockouts for 20mm conduit entry with additional cut-out facility to convert to 25mm conduit entry
- > IP66 sockets accept standard 13A plugs including moulded on plugs
- > Switches can be operated through membrane, thereby maintaining full IP rating



GWPIU3020

IP66 – 13A socket outlets

- BS 1363
- IP66 maintained whilst in use

Part number	Description	Qty
GWPIU3050	1 gang unswitched	1
GWPIU3060	2 gang unswitched	1
GWPIU3020	2 gang switched	1



GWPIU3020R

IP66 – 13A RCD socket outlets

- BS 7288
- IP66 maintained whilst in use

Part number	Description	Qty
GWPIU3020R	2 gang RCD 30mA - active	1
GWPIU3020RP	2 gang switched RCD 30mA Passive Passive devices do not require resetting in the event of power failure	1



GWP9000

IP66 grid enclosure & grid modules

- BS 5733
- BS EN 60670

Part number	Description	Qty
GWP9000	2 module enclosure	1
GWPIUKIT	IP66 seal kit 2 x silicone seals + 2 x mounting brackets	1

Weatherproof grid modules

- Standards (Where applicable) BS EN 60669-1, BS1363, BS 5733
- Key switch is supplied with common key

GRL2020PW	20AX 2 way and off switch module	1
GRL202KPW	20AX 2 way key switch module	1
GRL20DPNPW	20AX DP switch module with neon	1
GRL20DPKPW	20AX DP key switch module	1
GRL13FCUPW	13A SP Fuse carrier	1
GRLINDRPW	240V Red indicator	1
GRLCOPW	Cord outlet module (10mm dia.)	1



GWP1632

IP55 – 10AX switches

■ BS EN 60669-1

Part number	Description	Qty
GWP1612	1 gang 2 way	1
GWP1622	2 gang 2 way	1
GWP1632	3 gang 2 way	1
GWP1614	1 gang intermediate	1



GWP2011

IP55 – 20AX switches

■ BS EN 60669-1

Part number	Description	Qty
GWP2010	DP	1
GWP2011	DP with neon	1



GWP3020

IP55 - 13A socket outlets

■ BS 1363

Part number	Description	Qty
GWP3050*	1 gang unswitched	1
GWP3060*	2 gang unswitched	1
GWP3010*	1 gang switched	1
GWP3020*	2 gang switched	1

*IP4X whilst socket is in use



E551SS

IP55 - 13A socket outlets

■ IEC 60529

Part number	Description	Qty
E551US	13A 1 gang unswitched socket	1
E551SS	13A 1 gang switched socket	1
E552US	13A 2 gang unswitched socket	1



E5512S

IP55 - 10AX switches

Part number	Description	Qty
E5512S	10AX 1 gang 2 way switch	1
E5522S	10AX 2 gang 2 way switch	1
E55PB	10AX retractive switch	1



E55CB

IP55 - enclosure and grommets

Part number	Description	Qty
E55CB	Connection box	1
E55GP	Grommets (pk 10)	1

Kavacha

Kavacha weather protected accessories are made of heat resistant polycarbonate and utilise insulated screws for safe mounting on metal structures. They incorporate weatherproof gaskets that guarantee tight sealing to prevent penetration of water, as well as locking facility for safety purposes.



Features & benefits:

Switches

- > A safety feature for mounting switches to metal structures is the insulating caps that cover base mounting screws to totally protect them from any live cables
- > Impact resistant base and cover can both be subjected to violent collisions. They are sealed with 1 piece of weatherseal gasket
- > Lever is pad-lockable in the "OFF" position
- > For spilt-type air-conditioner, pump and any motor applications

Sockets

- > Usable with normal home appliance electrical plugs
- > Protection shield for socket outlet to ensure IP rating is maintained even when it is plugged
- > Drainage holes prevent accumulation of water droplets due to condensation
- > Large press dolly, easy lift cover
For swimming pool, garage, balcony and any outdoor utility areas



CSO313

IP56 - 13A socket outlets

- IEC 60529
- IEC 60669-1
- BS 1363
- BS 1363-2

Part number	Description	Qty
CSC313	13A switched socket	1
CSO313	13A 250V unswitched socket	1
CSO313Z	13A 250V twin unswitched socket	1



CSW1202

IP66 - switches

- IEC 60669-1

Part number	Description	Qty
CSW120	16A 250V 1 gang 2 way switch with looping terminal	1
CSW1202	20A 250V 2 gang 2 way switch with looping terminal	1
CSW220	20A 500V 1 gang DP isolator switch	1



WHB340RG

TP control switches

- IEC 60529

Part number	Description	Qty
WHB320RG	20A 440V TP surface mount isolator grey	1
WHB340RG	35A 440V TP surface mount isolator grey	1
WHB355RG	55A 440V TP surface mount isolator grey	1
WHC363RG	63A 440V TP surface mount isolator grey (32mm conduit entry each end)	1



CLIPSA
No. CS5320

56 Series dust-resistant and hose proof

They are made of ultra violet resistant PVC. An extensive choice of modules are available including switches and socket outlets. 56 Series offer safety in operation and are equipped with locking facility. Additionally, when plugs are removed, the socket cover automatically locks into place, preventing dust or water from entering.



56 Series modules

Designed to mix & match. Packed with features designed to outperform all other protected accessories



Captive stainless steel combination head fixings for corrosion resistance and effortless installation



8mm Padlock ON/OFF facility

Rotary ON/OFF switch



Permanent laser engraved ratings and specifications are durable & clearly displayed.



Redesigned transparent socket cover for improved visibility, strength & accessibility.



Larger and easy-to-use latch design. Socket cover automatically closes to ensure IP rating is maintained. Padlocking option available.





56SO313LEGY

IP66 - 13A socket outlet

- IEC 60529
- BS 1363

Part number	Description	Qty
56SO313LEGY	13A 250V 3 pin surface socket outlet - Grey	1
56SO313LERO	13A 250V 3 pin surface socket outlet - Resistant Orange	1
56C3134ELGY	13A 250V 1 gang socket with RCD protection - Grey	1
56C31324ELGY	13A 250V 2 gang socket with RCD protection - Grey	1
56CV313LEGY	13A 250V 1 gang combination surface switched socket outlet	1



56FCULEGY

IP66 - fuse units

- IEC 60529

Part number	Description	Qty
56FCULEGY	15A 250V switched fused spur - Grey	1



56SW120LEGY

IP66 - rotary switch

- IEC 60669-1
- IEC 60529

Part number	Description	Qty
56SW110LEGY	10A 250V 1 way rotary switch - Grey	1
56SW110LERO	10A 250V 1 way rotary switch - Resistant Orange	1
56SW120LEGY	20A 250V rotary switch - Grey	1
56SW120LERO	20A 250V rotary switch - Resistant Orange	1
56SW132LEGY	32A 250V rotary switch - Grey	1



56SW220LEGY

IP66 - DP switch disconnecter

- BS EN 60947-3

Part number	Description	Qty
56SW220LEGY	20A 500V DP switch disconnecter - Grey	1
56SW220LERO	20A 500V DP switch disconnecter - Resistant Orange	1
56SW232LEGY	32A 500V DP switch disconnecter - Grey	1
56SW232LERO	32A 500V DP switch disconnecter - Resistant Orange	1



56SW332LERO

IP66 - TP switch disconnector

■ BS EN 60947-3

Part number	Description	Qty
56SW310LEGY	10A 500V TP switch disconnector - Grey	1
56SW320LEGY	20A 500V TP switch disconnector - Grey	1
56SW320LERO	20A 500V TP switch disconnector - Resistant Orange	1
56SW332LEGY	32A 500V TP switch disconnector - Grey	1
56SW332LERO	32A 500V TP switch disconnector - Resistant Orange	1
56SW363LEGY	63A 500V TP switch disconnector - Grey	1
56SW363LERO	63A 500V TP switch disconnector - Resistant Orange	1



56SSW15LEGY

IP66 - control switches

■ IEC 60669-1

■ IEC 60529

Part number	Description	Qty
56SSW10LEGY	10A 250V single sliding dolly switch - Grey	1
56SSW15LEGY	15A 250V single sliding dolly switch - Grey	1
56SSW15LERO	15A 250V single sliding dolly switch - Resistant Orange	1
56SSW210LEGY	10A 250V DP double sliding dolly switch - Grey	1
56SSW215LEGY	15A 250V DP double sliding dolly switch - Grey	1
56SW220COLEGY	20A 500V DP changeover & reversing switch - Grey	1
56SW420LEGY	20A 440V 4 pole switch - Grey	1
56SW420LERO	20A 440V 4 pole switch - Resistant Orange	1



56SO3166LEGY

IP66 - industrial socket outlets

■ IEC 60529

■ BS 1363

Part number	Description	Qty
56SO3164LEGY	16A 4h 110/130V 3 pin surface socket outlet - Yellow	1
56SO3166LEGY	16A 16h 220/250V 3 pin surface socket outlet - Grey	1
56SO3326LEGY	32A 6h 220/250V 3 pin surface socket outlet - Grey	1
56SO4166LEGY	16A 6h 380/415V 4 pin surface socket outlet - Grey	1
56SO4326LEGY	32A 6h 380/415V 4 pin surface socket outlet - Grey	1
56SO5166LEGY	16A 6h 380/415V 5 pin surface socket outlet - Grey	1
56SO5326LEGY	32A 6h 380/415V 5 pin surface socket outlet - Grey	1



56P313GY

IP66 - plugs

■ IEC 60529

■ BS 1363

■ BS 546

Part number	Description	Qty
56P310GY	10A 250V 3 pin straight plug - Grey	1
56P313GY	13A 250V 3 pin straight plug - Grey	1
56P313RO	13A 250V 3 pin straight plug - Resistant Orange	1
56P315GY	15A 250V 3 pin straight plug - Grey	1



Moulded covers

- For use with Clipsal mechanisms
- IEC 60529
- BS 5733

Part number	Description	Qty
5632LEGY	2 aperture lid for mechanisms - Grey	1
5632LERO	2 aperture lid for mechanisms - Resistant Orange	1
56CB4GY	4 gang lid for 4P device - Grey	1
56CB4NGY	4 gang lid with neon for 4P din device - Grey	1
For use with mounting enclosures		
56L1GY	1 gang lid - Grey	1
56L2GY	2 gang lid - Grey	1



56E6GY



56E4VHGY



56E3GY

Surface mounted enclosures

- BS EN 60947-3

Part number	Description	Dimensions	Qty
56E1GY	Surface mount 1 module - Grey	101 x 101 x 63	1
56E1RO	Surface mount 1 module - Resistant Orange	102 x 101 x 63	1
56ED2GY	2 gang deep - Grey	198 x 101 x 100mm	1
56E2GY	2 gang - Grey	198 x 101 x 63mm	1
56E2RO	2 gang - Resistant Orange	199 x 101 x 63mm	1
56E3GY	3 gang - Grey	294 x 101 x 63mm	1
56E3RO	3 gang - Resistant Orange	294 x 101 x 63mm	1
56E4GY	4 gang - Grey	198 x 198 x 63mm	1
56E4RO	4 gang - Resistant Orange	198 x 198 x 63mm	1
56E4VHGY	4 gang vertical - Grey	391 x 101 x 63mm	1
56E6GY	6 gang - Grey	294 x 198 x 63mm	1
56E6RO	6 gang - Resistant Orange	294 x 198 x 63mm	1
56E8GY	8 gang - Grey	391 x 198 x 63mm	1
56E8RO	8 gang - Resistant Orange	391 x 198 x 63mm	1
56E9GY	9 gang - Grey	294 x 294 x 63mm	1
56ES1GY	Surface mount 1 module shallow - Grey	101 x 101 x 38	1
56ES2GY	Surface mount 2 module shallow - Grey	198 x 101 x 38	1
56ES2RO	Surface mount 2 module shallow - Resistant Orange	198 x 101 x 38	1



56FA1GY

Flush mounting surrounds

Part number	Description	Qty
56FA1GY	1 module flush surround - Grey	1
56FA2GY	2 module flush surround - Grey	1
56FA3GY	3 module flush surround - Grey	1
56FA4GY	4 module flush surround - Grey	1



56C313GY

Socket outlets with enclosures

- IEC 60529
- BS 1363

Part number	Description	Qty
56C313GY	13A 250V 3 pin combination surface switched socket outlet - Grey	1
56SO313GY	13A 250V 3 pin surface socket outlet - Grey	1
56SO332GY	32A 250V 3 pin surface socket outlet - Grey	1



56FCUGY

Switched fused connection units with enclosure

- IEC 60529

Part number	Description	Qty
56FCUGY	15A 250V switched fused spur - Grey	1



56JB1GY

Junction box

- IEC 60529
- BS 5733

Part number	Description	Qty
56JB1GY	1 gang junction box - Grey	1

Making the difference





Lunéta lighting

The right lighting can make all the difference to the atmosphere of a home, office or outdoor space.

Indoor lighting

Downlights.....	136-143
Transformers.....	144
Spare lamps.....	144
T4 & T5 mini battens.....	145-146
Cabinet and fluorescent.....	147
Shaver lights.....	148
Fluorescent battens.....	149-150
Diffusers and reflectors.....	151

Outdoor & amenity lighting

Drum lights.....	153-155
Spare low energy compact fluorescent, T4 &T5.....	156
Bulkhead and photocell kit.....	157
LED deck lights.....	157

Technical information.....	188-192
----------------------------	---------

Complement
any interior
styling

Indoor
lighting

Indoor lighting

Downlights

With a wide choice of lamp types and finishes, the downlights will complement any interior styling.

The range includes the latest LED technology for efficient energy savings. Each downlight has been colour matched with a choice of high quality finishes to complement the Ultimate wiring accessory range.

The range of fire rated and acoustic downlights in LED, low voltage, GU10 halogen, low energy mains versions ensure the latest building regulations are met together with Part L compliance, offering 637 lumens per watt.



Features & benefits:

Fire rated & Low Energy Fire rated

- > Die cast construction
- > Available in 3 popular finishes
- > Maintain fire resistance of load bearing floors for up to 90 minutes
- > IP65 shower version
- > Acoustic rating to BS EN ISO 140-3: 1995 and 140-6 1998
- > Moisture resistant seals for fixed versions
- > Low energy versions supplied with 7W GU10 low energy saving lamp

Die Cast and Pressed metal

- > Fixed, tilt and shower versions
- > Available in a choice of finishes to match the Ultimate screwless and flat plate accessory ranges
- > Shower versions rated to IP65

Transformers

- > Available in 65VA – 200VA
- > Compact installer friendly design
- > Re-settable cut out switch on Performer Plus range
- > Power on LED on Performer Plus range

LED 12W fire-rated downlights with integral lamp



- Integral 12W LED lamp
- 50,000 hour lamp life
- 3000k temperature - Warm white
- Supplied with separate driver unit for peace of mind
- 45W lumens per watt - satisfies requirements of Part L1
- Unique retention clip maintains fire rating performance
- Equivalent light output - 50W Halogen GU10
- Beam angles
 - Fixed - 45°
 - Tilt - 30°
 - Shower - 45°
- Lumens = 637lm
- Candela = 1300cd
- Colour Rendering Ra = 83

- Cut-out (mm): 76-85mm
- Maximum depth: 82mm
- Overall diameter: 95mm



GDFCSLED12W

Part number	Description	Qty
Fixed		
GDFCLED12W	White	1
GDFCLED12BC	Brushed Chrome	1
GDFCLED12C	Chrome	1

- Cut-out (mm): 85mm
- Maximum depth: 105mm
- Overall diameter: 96mm

Tilt		
GDRSLED12W	White	1
GDRSLED12BC	Brushed Chrome	1
GDRSLED12C	Chrome	1



GDRSLED12W

- Cut-out (mm): 76-85mm
- Maximum depth: 82mm
- Overall diameter: 95mm

Shower		
GDFCSLED12W	White	1
GDFCSLED12BC	Brushed Chrome	1
GDFCSLED12C	Chrome	1

LED 7W fire-rated downlights (lamp supplied)



- Supplied with 7W GU10 Replacement LED lamp
- Approx 20,000 hours life
- 2800k temperature - Warm white
- Equivalent light output - 35W Halogen GU10
- Beam Angle - 35°
- Lumens = 210lm
- Candela = 500cd
- Colour Rendering Ra = 80

- Cut-out (mm): 72mm
- Maximum depth: 120mm
- Overall diameter: 86mm

Part number	Description	Qty
Fixed		
GDFFLED07W	White	1
GDFFLED07SS	Stainless Steel	1
GDFFLED07C	Polished chrome	1



GDFFLED07SS

- Cut-out (mm): 83mm
- Maximum depth: 110mm
- Overall diameter: 100mm

Tilt		
GDFTLED07W	White	1
GDFTLED07SS	Stainless Steel	1
GDFTLED07C	Polished chrome	1



GDFTLED07SS

- Cut-out (mm): 74mm
- Maximum depth: 130mm
- Overall diameter: 88mm

Shower		
GDFSLED07W	IP55 White	1
GDFSLED07SS	IP55 Stainless Steel	1
GDFSLED07C	IP55 Polished chrome	1



GDFSLED07SS



GDFLGEDW

Mains voltage low energy GU10 CFL (lamp included)



- Suitable for use with 7W GU10 lamp (code CFLR507W827GU)
- Moisture resistant seals
- Die cast construction c/w stirrup and enclosed terminal block
- Lamp: (GU10 7W)
- Cut-out (mm): 72mm
- Ceiling Depth: 135mm

Part number	Description	Qty
Fixed		
GDFLGEDW	White	10
GDFLGEDC	Polished chrome	10
GDFLGEDSS	Stainless steel	10

Low voltage MR16 halogen downlighters (lamp included)

- Max rating 50W when used with aluminised lamp (code HD50WM2582A). When used with non-aluminised lamps max rating of lamp must be 35W
- Shower version rated to IP65 and can be installed in Zones 1 and 2 (see technical page)
- Lamp: MR16 (50W max)
- Cut-out (mm): 72mm
- Ceiling Depth: 100mm



GDFLLD50SSL

Part number	Description	Qty
Fixed		
GDFLLD50WL	White	10
GDFLLD50CL	Polished chrome	10
GDFLLD50SSL	Stainless steel	10



GDFLLTD50SSL

Tilt		
GDFLLTD50WL	White	10
GDFLLTD50CL	Polished chrome	10
GDFLLTD50SSL	Stainless steel	10



GDFLLS50SSL

Shower		
GDFLLS50WL	White	10
GDFLLS50CL	Polished chrome	10
GDFLLS50SSL	Stainless steel	10

Mains voltage GU10 halogen downlighters (lamp included)

- Maintain fire resistance of load bearing floors for up to 90 minute ceilings to BS476 parts 20, 21 and 23
- Moisture resistant seals for fixed version
- Die cast construction c/w stirrup and enclosed terminal block
- Quick fix steel clips to ensure secure fixing
- Shower version rated to IP65
- Accoustic rating to BS EN ISO 140-3: 1995 and 140-6 1998
- Lamp: GU10 (50W max)
- Cut-out (mm): 72mm
- Ceiling Depth: 100mm



GDFLGD50SSL

Part number	Description	Qty
Fixed		
GDFLGD50WL	White	10
GDFLGD50CL	Polished chrome	10
GDFLGD50SSL	Stainless steel	10



GDFLGD50SSL

Tilt		
GDFLGD50WL	White	10
GDFLGD50CL	Polished chrome	10
GDFLGD50SSL	Stainless steel	10



GDFLGS50SSL

Shower		
GDFLGS50WL	White	10
GDFLGS50CL	Polished chrome	10
GDFLGS50SSL	Stainless steel	10



GDLLD50C

Low voltage MR16 halogen downlighters (lamp required)

- Lamp: MR16 (50W max)
- Cut-out (mm): 60mm
- Ceiling Depth: 116mm
- Diameter: 80mm

Part number	Description	Qty
Fixed		
GDLLD50W	White	6
GDLLD50C	Polished chrome	6
GDLLD50SS	Stainless steel	6
GDLLD50BN	Black nickel	6



GDLLTD50BN

- Lamp: MR16 (50W max)
- Cut-out (mm): 65mm
- Ceiling Depth: 116mm
- Diameter: 80mm

Tilt		
GDLLTD50W	White	6
GDLLTD50C	Polished chrome	6
GDLLTD50SS	Stainless steel	6
GDLLTD50BN	Black nickel	6



GDLGD50SS

Mains voltage GU10 halogen downlighters (lamp included)

- Lamp: GU10 (50W max)
- Cut-out (mm): 60mm
- Ceiling Depth: 116mm
- Diameter: 80mm

Part number	Description	Qty
Fixed		
GDLGD50W	White	6
GDLGD50C	Polished chrome	6
GDLGD50SS	Stainless steel	6
GDLGD50BN	Black nickel	6



GDLGTD50BN

- Lamp: GU10 (50W max)
- Cut-out (mm): 65mm
- Ceiling Depth: 116mm
- Diameter: 80mm

Tilt		
GDLGTD50W	White	6
GDLGTD50C	Polished chrome	6
GDLGTD50SS	Stainless steel	6
GDLGTD50BN	Black nickel	6



GDLL50C

Low voltage MR16 downlighters (lamp required)

- Lamp: MR16 (50W max)
- Cut-out (mm): 65mm
- Ceiling Depth: 116mm
- Diameter: 80mm

Part number	Description	Qty
Fixed		
GDLL50C	Polished chrome	6
GDLL50W	White	6
GDLL50SS	Stainless steel	6
GDLL50BN	Black nickel	6



GDLLT50BN

- Lamp: MR16 (50W max)
- Cut-out (mm): 80mm
- Ceiling Depth: 116mm
- Diameter: 105mm

Tilt		
GDLLT50C	Polished chrome	6
GDLLT50W	White	6
GDLLT50SS	Stainless steel	6
GDLLT50BN	Black nickel	6



GDLLS50C

Low voltage MR16 halogen shower lights (lamp required)

- Lamp: MR16 (50W max)
- Cut-out (mm): 72.5mm
- Ceiling Depth: 100mm
- Diameter: 83mm
- Suitable for use in Zone 1
- For technical information see page 188-192

Part number	Description	Qty
GDLLS50C	Polished chrome	1
GDLLS50W	White	1
GDLLS50SS	Stainless steel	1
GDLLS50BN	Black nickel	1



GDLLS50BN

Mains voltage GU10 downlighters (lamp included)

- Fixed and tilt models
- Complete with stirrup and covered terminal block, quick fit steel spring clips and a lamp retaining clip
- For use with max 50W MR16 dichroic lamp (not included) or mains voltage GU10 lamp (included)
- Individually boxed
- Dichroic lamps reflect the heat backwards to provide a cool beam while GU10 lamps reflect heat forwards
- Suitable for commercial and domestic applications



GDLG50C

- Lamp: GU10 (50W max)
- Cut-out (mm): 65mm
- Ceiling Depth: 116mm
- Diameter: 80mm

Part number	Description	Qty
Fixed		
GDLG50C	Polished chrome	6
GDLG50W	White	6
GDLG50SS	Stainless steel	6
GDLG50BN	Black nickel	6



GDLGT50SS

- Lamp: GU10 (50W max)
- Cut-out (mm): 60mm
- Ceiling Depth: 116mm
- Diameter: 115mm

Tilt		
GDLGT50C	Polished chrome	6
GDLGT50W	White	6
GDLGT50SS	Stainless steel	6
GDLGT50BN	Black nickel	6

Mains voltage GU10 halogen shower lights (lamp included)

Features:

- Suitable for use in bathrooms and shower cubicles
- Clear glass diffuser
- Also suitable for exterior use (IP54 rated), for example on porches
- Die cast construction c/w stirrup and enclosed terminal block
- For use with max 50W MR16 dichroic lamp (not included) or mains voltage GU10 lamp (included)
- Lamp: MR16 (50W max)
- Cut-out (mm): 72.5mm
- Ceiling Depth: 100mm
- Diameter: 83mm
- For technical information see page 188-192



GDLGS50SS



GDLGS50C

Part number	Description	Qty
GDLGS50C	Polished chrome	1
GDLGS50W	White	1
GDLGS50SS	Stainless steel	1
GDLGS50BN	Black nickel	1



GTRE105

Transformers – Performer

- Compact installer friendly design
- For use with GET low voltage luminaires
- 5 year guarantee

Part number	Description	Dimensions (w,h,d)	Weight (g)	Qty
GTRE65	65VA electronic dimmable transformer	124 x 40 x 30	97	1
GTRE105	105VA electronic dimmable transformer	124 x 40 x 30	1129	1
GTRE150	150VA electronic dimmable transformer	208 x 55 x 40	270	1
GTRE200	200VA electronic dimmable transformer	208 x 55 x 40	290	1



GTRE105P

Transformers – Performer Plus

- Compact installer friendly design
- For use with GET low voltage luminaires
- Resettable thermal cut out switch
- Power on LED indicator
- Unique central earthing posting system
- 10 year guarantee

Part number	Description	Dimensions (w,h,d)	Weight (g)	Qty
GTRE65P	65VA electronic dimmable transformer	124 x 40 x 30	107	1
GTRE105P	105VA electronic dimmable transformer	147 x 40 x 30	1219	1
GTRE150P	150VA electronic dimmable transformer	208 x 55 x 40	280	1
GTRE200P	200VA electronic dimmable transformer	208 x 55 x 40	300	1

Low voltage dichroic halogen and aluminised lamps

- Cap: MR16 – GU5.3Beam: 38°
- GU5.3: Average rated life 4000 hours
- M2692 & M2582: Average rated life 2000 hours
- Suitable for display lighting
- Suitable for dimming



Part number	Watts	Volts	Qty
Dichroic			
HD35WM281	35W	12V	20
HD50WM258	50W	12V	20
Aluminised			
HD50WM2582A	50W	12V	20



CFLR507W827GU

Energy saving GU10 lamps

- Cap: GU10
- Colour: Warm white 827

Part number	Watts	GLS	Volts	Qty
CFLR507W827GU	7W	35W	240V	10



HD50WGU10

Mains aluminised halogen lamps

- Cap: GU10 Beam: 36°
- Providing crisp clean light for use in downlighters and uplighters
- Suitable for dimming
- Does not require transformer

Part number	Watts	Volts	Qty
HD35WGU10	35W	240V	10
HD50WGU10	50W	240V	10

Indoor lighting

Cabinet & under shelf range

A traditional range of low voltage cabinet lighting and mains voltage striplights. Cabinet lights are available in 2 finishes. The T4 and T5 range of mini batten link light is designed for under cabinet and display lighting applications.

The T5 fittings are supplied with diffusers and both ranges can be linked either directly or by an extension cable enabling complete flexibility. Also included is a range of low energy cabinet lights which are ideal for under cabinets, shelves and wardrobes. These are compact in design, available in 3 finishes and supplied with an energy saving 7W GX53 lamp.

Features & benefits:

Mini batten link lighting

- > T4 and T5 mini battens can be interconnected directly or by using the link cable (supplied)
- > Supplied with triphosphor fluorescent tube
- > Electronic flicker free operation
- > Separately switched
- > Diffuser (T5 only)

Low voltage cabinet lights

- > Supplied complete with a G4 lamp
- > Luminaires supplied with removable mounting collar for surface or flush mounting.

Low energy cabinet lights

- > Supplied complete with 7W GX53 lamp
- > 3 finishes: white, chrome and stainless steel
- > Average rated life is 8000 hours



T4 under cupboard link lighting (with lamp)



Part number	Description	Lamp	Length	Qty
GT4FL6W35	Mini batten link light - 6W	T4 fluorescent	275mm	1
GT4FL10W35	Mini batten link light - 10W	T4 fluorescent	400mm	1
GT4FL16W35	Mini batten link light - 16W	T4 fluorescent	500mm	1
GT4FL20W35	Mini batten link light - 20W	T4 fluorescent	625mm	1
GT4FL30W35	Mini batten link light - 30W	T4 fluorescent	760mm	1
LINK500	500mm link cable			1
LINK1M	1m link cable			1



T5 under cupboard link lighting (with lamp & diffuser)



- Supplied with linking cable
- All mini battens can be interconnected directly or with link cable (supplied)
- Electronic flicker free operation
- Supplied with 3500K triphosphor white tube
- Full fitting instructions and fixing kit included
- T5 supplied with diffuser
- Replacement tubes available
- Separately switched
- BS EN 60598

Part number	Description	Lamp	Length	Qty
GT5FL8W35	Mini batten link light - 8W	T5 fluorescent	300mm	1
GT5FL13W35	Mini batten link light - 13W	T5 fluorescent	530mm	1
GT5FL21W35	Mini batten link light - 21W	T5 fluorescent	900mm	1
GT5FL28W35	Mini batten link light - 28W	T5 fluorescent	1200mm	1
LINK5005	500mm link cable			1
LINK1M5	1m link cable			1



Direct and cable link



T4FL16W35

T4 compact fluorescent tubes



- To fit GET mini batten range
- Colour: white 35

Part number	Length	Watts	Volts	Qty
T4FL6W35	11" 275mm	6W	230V	10
T4FL10W35	16" 400mm	10W	230V	10
T4FL16W35	20" 500mm	16W	230V	10
T4FL20W35	25" 625mm	20W	230V	10
T4FL30W35	30" 760mm	30W	230V	10



T5FL6W33

T5 compact fluorescent tubes



- Suitable for kitchens, task lighting and emergency lighting
- Colour: white 35

Part number	Length	Watts	Volts	Qty
T5FL4W35	6" 150mm	4W	240V	25
T5FL6W35	9" 225mm	6W	240V	25
T5FL8W35	12" 300mm	8W	240V	25
T5FL13W35	21" 525mm	13W	240V	25



GDLLC20C – Surface Mounted

Low voltage cabinet lights (lamp included)



- Frosted glass lens
- Single lights have 1.5m cable (no connectors)
- Removable mounting collar for surface or flush mounting
- BS EN 60598-1
- Lamps: G4 halogen capsule
- Dimensions: 70mm diameter, 28mm depth (surface mounted)
- Ceiling depth: 20mm (flush mounted)
- Weight: 187gms

Part number	Description	Qty
GDLLC20C	20W Chrome	1
GDLLC20W	20W White	1



Surface Mounted

GX53 low energy cabinet lights (with lamp)



- Compact design
- Ideal for under cabinets, shelves and wardrobes
- Lamps: GX53 7W
- Dimensions: 90mm diameter, 29mm depth (surface mount)

Part number	Description	Qty
GDLGX53C	7W CFL chrome	1
GDLGX53W	7W CFL white	1
GDLGX53SS	7W CFL stainless steel	1



Fixed glass



Floating glass



Fitting c/w control gear

Compact fluorescent downlighters (lamp required)



A highly efficient low energy downlighter using horizontally mounted compact fluorescent lamps. Available in two options, either fixed or a floating glass. The floating glass helps to reflect a little of the light upwards to accent the ceiling and hide the lamp

- Electro brightened aluminium reflector
- Pre-wired separate control gear box with easy access for termination
- Switch start control gear (LPF)
- Horizontal lamp position
- Use with CFL fluorescent lamp
- Lamps: CFL fluorescent
- Cut out: 180mm
- Ceiling depth: 100mm
- Dimensions: 210mm diameter
- Weight: 1.5kg

Part number	Description	Qty
Fixed glass cover		
GDLCS126G	Single 26W with fixed glass	1
GDLCS226G	Twin 26W with fixed glass	1

Etched floating glass cover

GDLCS226FG	Twin 26W with floating glass	1
------------	------------------------------	---



Shaver lights (lamp included)



A stylish range of four shaver light units are designed to complement even the most modern of bathrooms, the soft lines ensure compatibility with any décor whilst limiting dust and dirt collection. Even light dissipation is achieved through the opal diffuser whilst also providing safe disconnection of lamp contacts (when removed for easy replacement of lamps – 60W variants only).

Careful attention has been paid for fast and easy installation including a removable back plate and terminal access for wiring even after the unit has been fixed to the wall. The range is fully certified to all of the relevant safety standards.

Lighting in locations containing a bath or shower.

These illustrations and the advice below are based on BS 7671:2008 the IEE Wiring Regulations 17th Edition, Section 701. For full details please look in this document.

For lighting installed in Zones 1 and 2 all luminaires must be at least IPX4, or IPX5 if water jets are used for cleaning. The GET Shaverlight range is IP20 and must be installed outside Zones 0, 1 and 2.

All circuits for current-using equipment and accessories must be protected by RCD's of 30mA rating.

SELV (12V ac) luminaires must have the SELV source (transformer) outside the zones e.g. in the ceiling void.

Features

- Stylish modern design blends with any décor
- Opal diffuser for a softer light
- Fitted with earth looping terminal
- Supplied with loose back plate for faster fixing
- 60W fittings provide safe disconnection of lamp contact once the diffuser is removed
- Easy connection method
- Suitable for use in bathrooms (see Zone information below)
- Manufactured in flame retardant polycarbonate
- IP20
- Maximum lamp rating 60W
- Supplied pre-fitted with 284mm striplight or 11W CFL fluorescent lamp
- Manufactured in flame retardant polycarbonate
- Compatible with UK, Europe, Australia and USA regulations
- Complies with BS EN 60598-2-1
- Lamps: 60W Striplights or 11W CFL fluorescent (lamps included)
- Dimensions: 500mm(L) x 60mm(W) x 70mm(H)



Part number	Description	Qty
GSHVLITL	60W Tungsten single voltage 230V output	1
GSHVLIT2L	60W Tungsten dual voltage 115/230V output	1
GSHVLITFL2L	11W Fluorescent dual voltage 115/230V output	1

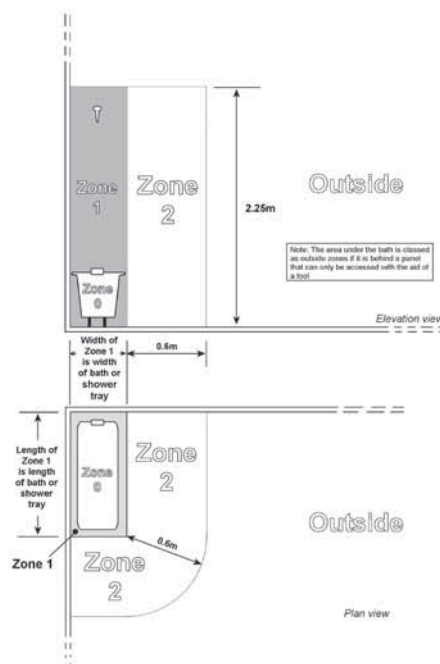

Bathroom lights must be installed in accordance with IEE regulations,



Shaver lights have concealed/protected dual voltage shutter socket

Indoor lighting

fluorescent battens & diffusers

The range of fluorescent battens from Schneider Electric is the ideal choice for commercial, industrial or domestic installations – combining quality, style, ease of installation and value for money.

- > High impact moulded lamp holder end cap assemblies
- > Powder coated steel casing for durability and enhanced rigidity
- > High temperature cable for electrical safety
- > High quality starter for reliability and long life
- > Large terminal connectors and cable entry for ease of wiring
- > Approved ballasts for long operational life and low noise emissions
- > Easy fit cover tray, simply turn the twist lock at each end of the batten for fuss free installation and maintenance without the use of a tool
- > High quality long life power factor correction capacitor (HPF versions)
- > Integral 3 hour battery back up (Emergency versions)

Features & benefits:

Mini batten link lighting

- > T4 and T5 mini battens can be interconnected directly or by using the link cable (supplied)
- > Supplied with triphosphor fluorescent tube
- > Electronic flicker free operation
- > Separately switched
- > Diffuser (T5 only)

Low voltage cabinet lights

- > Supplied complete with a G4 lamp
- > Luminaires supplied with removable mounting collar for surface or flush mounting.

Low energy cabinet lights

- > Supplied complete with 7W GX53 lamp
- > 3 finishes: white, chrome and stainless steel
- > Average rated life is 8000 hours

Bare batten (complete with lamp)



- Supplied with white 35 T8 fluorescent tubes
- Durable slim line steel construction
- Width of base 54mm
- Simple 90° turn twist toggles allow for easy access to the gear tray without the need for tools
- Large terminal blocks for fast and easy cable connection
- High quality epoxy powder coated finish
- UV stabilised, non colouring, high impact end cap assemblies
- End cap knockouts - no special tool or end cap drilling required
- Low and high power factor battens for general use
- Emergency available to order (high power factor only)
- Volts: 240V



LP236LPP

Part number	Description	Wattage	Qty
Low power factor			
LP118LPP	650mm (2ft) single	18W	8
LP218LPP	650mm (2ft) twin	18W	8
LP136LPP	1225mm (4ft) single	36W	8
LP236LPP	1225mm (4ft) twin	36W	8
LP158LPP	1525mm (5ft) single	58W	8
LP258LPP	1525mm (5ft) twin	58W	8
LP170LPP	1790mm (6ft) single	70W	8
LP270LPP	1790mm (6ft) twin	70W	8



LP118HPP

High power factor			
LP118HPP	650mm (2ft) single	18W	8
LP218HPP	650mm (2ft) twin	18W	8
LP136HPP	1225mm (4ft) single	36W	8
LP236HPP	1225mm (4ft) twin	36W	8
LP158HPP	1525mm (5ft) single	58W	8
LP258HPP	1525mm (5ft) twin	58W	8
LP170HPP	1790mm (6ft) single	70W	8
LP270HPP	1790mm (6ft) twin	70W	8

Bare batten - high frequency (complete with lamp)



- No visible flicker
- No audible noise
- First time starting
- Reduced running cost (typically 25% energy savings)
- Lower weight
- Easier maintenance
- Further power factor improvement
- up to 5% increase in lumen performance
- Longer lamp life
- Volts: 240V



LP258HF

Part number	Description	Wattage	Qty
LP136HF	1225mm (4ft) single	36W	8
LP236HF	1225mm (4ft) twin	36W	8
LP158HF	1525mm (5ft) single	58W	8
LP258HF	1525mm (5ft) twin	58W	8
LP170HF	1790mm (6ft) single	70W	8
LP270HF	1790mm (6ft) twin	70W	8

Bare batten - emergency - high frequency (complete with lamp)



- 3 hour self contained/maintained
- LED charge indicator



LP158HFE

Part number	Description	Wattage	Qty
LP136HFE	1225mm (4ft) single	36W	8
LP236HFE	1225mm (4ft) twin	36W	8
LP158HFE	1525mm (5ft) single	58W	8
LP258HFE	1525mm (5ft) twin	58W	8
LP170HFE	1790mm (6ft) single	70W	8
LP270HFE	1790mm (6ft) twin	70W	8



LPSK136



LPSK258

Square diffusers

- Prismatic acrylic diffuser for low glare soft light
- No special tooling required for installation and maintenance
- For use with GET battens
- Includes lipped cover tray for snug fit which minimises insect ingress and reduces routine cleaning
- UV stabilised high impact end caps which do not allow light to penetrate

Part number	Description	Qty
LPSK118	650mm (2ft) single	4
LPSK218	650mm (2ft) twin	4
LPSK136	1225mm (4ft) single	4
LPSK236	1225mm (4ft) twin	4
LPSK158	1525mm (5ft) single	4
LPSK258	1525mm (5ft) twin	4
LPSK170	1790mm (6ft) single	4
LPSK270	1790mm (6ft) twin	4



LPDK118



LPDK258

Round diffusers

- Prismatic acrylic diffuser for low glare soft light
- No special tooling required for installation and maintenance
- For use with GET battens
- Provides lower light loss than conventional square diffusers
- UV stabilised high impact end caps which do not allow light to penetrate

Part number	Description	Qty
LPDK118	650mm (2ft) single	4
LPDK218	650mm (2ft) twin	4
LPDK136	1225mm (4ft) single	4
LPDK236	1225mm (4ft) twin	4
LPDK158	1525mm (5ft) single	4
LPDK258	1525mm (5ft) twin	4



LPRK70W

Metal reflectors

- Suitable for single and double tube battens
- Powder coated steel for a smooth durable finish
- Broad lighting distribution
- For use with GET battens

Part number	Description	Qty
LPRK36W	1225mm (4ft) single	4
LPRK58W	1525mm (5ft) single	4
LPRK70W	1790mm (6ft) single	4



Outdoor & amenity lighting

Our outstanding range of amenity drum lights have been designed to encompass durability with excellent lighting performance. A unique feature of the drum range is a surface wiring facility as well as a hinged demountable gear tray.

The low voltage LED decklights range is ideal for decking, drives, walls and floors. These are available in 5 different colours.



Features & benefits:

Drums

- > Range of compact fluorescent & LED fittings complete with lamps
- > High IP65 rating for indoor and outdoor use
- > Low level 20mm conduit entries for easy installation
- > Unique surface wiring facility & hinged, demountable gear tray for easy wiring
- > Compact fluorescent lamp included with fitting for low installation and running costs
- > Suitable for pedestrian corridors, stairwells, subways and general amenity / security areas
- > Emergency drums have an integral 3 hour battery back up

Bulkheads

- > Provide light for safety and security.
- > Choice of GLS and energy saving lamp options
- > Includes photocell that illuminates at a preset light level

Photocell kit

- > Designed for control of outdoor lighting, suitable for wall mounting
- > IP65 rated
- > Photo-diode sensor
- > Electromagnetic relay

LED Decklights

- > Suitable for decking, drives, pathways, walls and floors.
- > Up to 20 LED's can be run on the transformer supplied.
- > Energy saving and safe to touch as operate cool

LED drums



- Dimensions: Ø 283x85mm
- Lamp information: 16W cool white
- Beam angle: 120°
- 62lm/W
- IP65
- Operating temperature: -20°C - 40°C
- Offers 15,000 hours service life with built-in driver
- EN60598-1



GDFLED16WWO



GDFLED16WBO



GDFLLED16WCO

Part number	Description	Qty
White base		
GDFLED16WWO	16W large round drum, opal diffuser	1
GDFLED16WWP	16W large round drum, prismatic diffuser	1
Black base		
GDFLED16WBO	16W large round drum, opal diffuser	1
GDFLED16WBP	16W large round drum, prismatic diffuser	1

Lunar decorative range

- Dimensions: Ø 326x108mm
- IP54

Part number	Description	Qty
GDFLLED16WCO	16W large round drum, opal diffuser, chrome surround	1
GDFLLED16WWO	16W large round drum, opal diffuser, white surround	1
GDFLLED16WSO	16W large round drum, opal diffuser, silver surround	1

Emergency LED drums



- Dimensions: Ø 283x85mm
- Lamp information: 16W cool white
- Beam angle: 120°
- 62lm/W
- IP65
- Operating temperature: -20°C - 40°C
- Offers 15,000 hours service life with built-in driver
- EN60598-1
- Battery: 1.2Vx15pcsx900mAH rechargeable Ni-H battery endurance time: >3 hrs



GDFLED16WWOE



GDFLED16WBOE



GDFLLED16WWOE

Part number	Description	Qty
White base		
GDFLED16WWOE	16W large round drum, opal diffuser	1
GDFLED16WWPE	16W large round drum, prismatic diffuser	1
Black base		
GDFLED16WBOE	16W large round drum, opal diffuser	1
GDFLED16WBPE	16W large round drum, prismatic diffuser	1

Lunar decorative range

- Dimensions: Ø 326x108mm
- IP54

Part number	Description	Qty
GDFLLED16WCOE	16W large round drum, opal diffuser, chrome surround	1
GDFLLED16WWOE	16W large round drum, opal diffuser, white surround	1
GDFLLED16WSOE	16W large round drum, opal diffuser, silver surround	1

Compact fluorescent drums – switch start (2 pin lamp included)



■ Lamp: 2 pin compact double D

Part number	Description	Qty
White base		
GDFRS16WWO	16W round drum, opal diffuser, 255mm diameter	1
GDFRS16WWP	16W round drum, prismatic diffuser, 255mm diameter	1
GDFR16WWO	16W large round drum, opal diffuser, 285mm diameter	1
GDFR16WWP	16W large round drum, prismatic diffuser, 285mm diameter	1
GDFR28WWO	28W large round drum, opal diffuser, 285mm diameter	1
GDFR28WWP	28W large round drum, prismatic diffuser, 285mm diameter	1
GDFS16WWO	16W large square drum, opal diffuser, 255 x 255mm	1
GDFS16WWP	16W large square drum, prismatic diffuser, 255 x 255mm	1
GDFS28WWO	28W large square drum, opal diffuser, 255 x 255mm	1
GDFS28WWP	28W large square drum, prismatic diffuser, 255 x 255mm	1

Black base

GDFRS16WBO	16W round drum, opal diffuser, 255mm diameter	1
GDFRS16WBP	16W round drum, prismatic diffuser, 255mm diameter	1
GDFR16WBO	16W large round drum, opal diffuser, 285mm diameter	1
GDFR16WBP	16W large round drum, prismatic diffuser, 285mm diameter	1
GDFR28WBO	28W large round drum, opal diffuser, 285mm diameter	1
GDFR28WBP	28W large round drum, prismatic diffuser, 285mm diameter	1
GDFS16WBO	16W large square drum, opal diffuser, 255 x 255mm	1
GDFS16WBP	16W large square drum, prismatic diffuser, 255 x 255mm	1
GDFS28WBO	28W large square drum, opal diffuser, 255 x 255mm	1
GDFS28WBP	28W large square drum, prismatic diffuser, 255 x 255mm	1



GDFR28WWO



GDFS28WWP



GDFRS16WBO

Emergency compact fluorescent drums with integral battery back-up – high frequency (4 pin lamp included)



- Vandal resistant all-polycarbonate construction
- Hinged gear-tray for quick easy installation
- Unique easy-seal surface wiring facility
- Low-level positioned 20mm conduit entries – no conduit bending needed
- IP65 for outdoor and indoor use (including bathroom Zone 1)
- Four screw positive cover fixing to maintain IP65 integrity
- Supplied complete with 16 and 28W lamps (colour 3500K)
- BESA box fitting facility
- Replacement lamps available
- Emergency Luminaires:
 - 3 hour self contained maintained
 - 4 pin 16 and 28W 3500K lamp included
- Lamp: 4 pin compact double D

Part number	Description	Qty
White base		
GDFR28WWOE	28W large round drum, opal diffuser, 285mm diameter	1
GDFR28WWPE	28W large round drum, prismatic diffuser, 285mm diameter	1
GDFS28WWOE	28W large square drum, opal diffuser, 255 x 255mm	1
GDFS28WWPE	28W large square drum, prismatic diffuser, 255 x 255mm	1

Black base

GDFR16WBOE	16W large round drum, opal diffuser, 285mm diameter	1
GDFR28WBOE	28W large round drum, opal diffuser, 285mm diameter	1
GDFR28WBPE	28W large round drum, prismatic diffuser, 285mm diameter	1
GDFS28WBOE	28W large square drum, opal diffuser, 255 x 255mm	1
GDFS28WBPE	28W large square drum, prismatic diffuser, 255 x 255mm	1



GDFR28WWOE



GDFS28WWOE



GDFR16WBOE



GX53FL7W

Energy saving GX53



■ Cap: GX53

Part number	Watts	GLS	Volts	Qty
GX53FL7W	7W	35W	240V	10



CFLDD28W8352P

Tubular compact double D 2 pin



- Colour temperature:
 - Cap: GR8 835 White 3500K
- Average rated life 8000 hours
- Not suitable for dimming

Part number	Watts	Volts	Qty
CFLDD16W8352P	16W	240V	10
CFLDD28W8352P	28W	240V	10



CFLDD28W8274P

Tubular compact double D 4 pin



- Colour temperature:
 - Cap: GR10 835 White 3500K
- Can be dimmed with suitable control gear

Part number	Watts	Volts	Qty
CFLDD16W8354P	16W	240V	10
CFLDD28W8354P	28W	240V	10
CFLDD38W8354P	38W	240V	10



GBH100BR

Bulkheads (lamp required)

- Bulkheads are a tough reliable solution to provide light for safety and security
- They come with a choice of GLS and Energy Saving lamp options
- Lamps: BC GLS or 9W CFL energy saving
- Choice of GLS or energy saving options
- IP65
- Manufactured from die-cast aluminium
- Powder coated paint finish for extra durability
- Corrosion resistant
- Tough UV stabilised polycarbonate cover
- Choice of 20mm knockouts for cable and/or conduit entry
- Suitable for use in exterior application such as walkways and paths

Part number	Description	Qty
GBH100BC	100W with clear diffuser	10
GBH100BR	100W with red diffuser	10



GPC500CK

Photocell kit

- Photocell kit comprises photocell head, mounting bracket and fixings
- Electromagnetic relay
- Load: 2 x 250W HPS typical
- Max capacity: 5A/60µf
- On/off levels: 70/105 Lux (1:1.5 + VE)
- IP rating: IP65
- BS 5972

Part number	Description	Qty
GPC500CK	Clear electronic photocell kit	1



LED decklight kit – 4 twin LED light unit & accessories

- Lamp Colour: White
- LED Life of up to 100,000 hours (non replaceable)
- Operate cool - safe to touch when operating (safe for children/pets)
- Kit includes 12V 10VA transformer
- Up to 20 LEDs can be run on the transformer supplied
- Illuminate step edges for added safety
- Decorate your decking/flooring
- LED's are less damaging to the environment than incandescent lamps as they use up to 90% less energy

Part number	Description	Qty
GGLLEDK4W	LED decklight kit with stainless steel finish and 4 twin LED light units, 10m cable, low voltage transformer, connectors and a 25mm drill bit	1

Part number	Description	Lamp colour	Qty
GGLLED1W	LED decklight add-on	White	1
GGLLED1G	LED decklight add-on	Green	1
GGLLED1A	LED decklight add-on	Amber	1
GGLLED1B	LED decklight add-on	Blue	1
GGLLED1R	LED decklight add-on	Red	1



GGLLED1W



GLLTR60

Transformers	Dimensions (L, W, D)	Qty	
GLLTR60	60VA transformer with screw connector	102 x 63 x 75mm	1
GLLTR105	105VA transformer with screw connector	120 x 80 x 75mm	1

Increased comfort & hygiene





Cyclone

Ventilation & heating

Air movement and oscillation are important to any building and Schneider Electric has the expertise to meet a variety of heating and ventilation needs. Our air movement products promise increased comfort and hygiene in the office or at home.

End users can expect quick and easy installation and neat designs that slot into the smallest spaces. There are also portable solutions that offer convenience and flexibility.

Finishes range from classic white to decorative chrome to match other fixtures and fittings.

Cyclone – Extractor fans

100mm (4") Slimline fans.	162
100mm (4") Turbo slimline fans.	162
100mm (4") Turbo panel fans	162
100mm (4") Turbo glass panel fans	162
100mm (4") shower fans	163
150mm (6") extractor fans	163
Accessories	163

Warm air

Panel heaters	166
Hand dryers.	166
Downflow bathroom heaters	166
Fixed & portable heaters.	167

Technical information.	193-194
---	----------------

Optimum air
extraction

Ventilation

Cyclone extractor fans

Effective ventilation and air movement is vital in order to maintain high levels of comfort and hygiene in the office or at home.

Our Cyclone range has been designed to provide an innovative approach that complements modern interior styling and fittings.

The ventilation offer is sectioned into three levels: Standard, Premium and Designer.

Features & benefits:





GFANC4SL



GFANC4SLC



GSSTFAN4T



GSPTFAN4T



GPGPTFAN4TW



GFAN4P



GFAN412

100mm (4") slimline fans

- 12mm Ultra Slim wall projection
- Extraction capacity – 93m³/hr
- Suitable for wall or ceiling mounting
- White or chrome finishes

Part number	Description	Qty
GFANC4SL	Standard	1
GFANC4SLT	With timer	1
GFANC4SLC	Chrome effect	1
GFANC4SLTC	Chrome effect with timer	1

100mm (4") turbo slimline fans

- Extraction capacity 129m³/hr
- Suitable for wall or ceiling mount
- 12mm ultra slim wall projection

Part number	Description	Qty
GSSTFAN4T	With timer - white	1
GSSTFAN4TH	With timer and humidistat control - white	1

100mm (4") turbo panel fans

- Extraction capacity 115m³/hr
- Suitable for wall or ceiling mount

Part number	Description	Qty
GSPTFAN4T	With timer - white	1
GSPTFAN4TA	With timer - aluminium	1

100mm (4") turbo glass panel fans

- Extraction capacity 115m³/hr
- Suitable for wall or ceiling mount

Part number	Description	Qty
GPGPTFAN4TB	Panel fan with timer - black glass	1
GPGPTFAN4TW	Panel fan with timer - white glass	1

Standard (4") extractor fans

- Extraction capacity 93m³/hr
- Suitable for wall or ceiling mounting

Part number	Description	Qty
GFAN4	Standard	1
GFAN4P	Pull cord	1
GFAN4T	Timer	1
GFAN4H	Humidistat control	1

12V SELV (safe extra low voltage)

- Suitable for wall or ceiling mounting
- Extraction capacity – 93m³/hr

Part number	Description	Qty
GFAN412	Standard incl. transformer	1
GFAN412T	Timer incl. transformer	1



GFANIL

Inline shower fan kit

- Suitable for loft installation
- Extraction capacity – 93m³/hr

Part number	Description	Qty
GFANIL	100mm (4") Inline shower fan kit	1
GFANILT	100mm (4") Inline shower fan kit with timer	1



GFAN4SWRT

Inline 12V SELV shower fan kit & light (safe extra low voltage)

- Kit contains fan, flexible PVC hose, grilles and fixings
- Suitable for ceiling mounting only
- Extraction capacity – 93m³/hr
- Lamp: MR16 20W

Part number	Description	Qty
GFAN4SWRT	Shower fan with 20W light and timer	1



GFAN6

150mm (6") extractor fan

- Extraction capacity 250m³/hr
- Suitable for wall or ceiling mounting

Part number	Description	Qty
GFAN6	Standard	1
GFAN6P	Pull cord override	1
GFAN6T	Timer	1
GSFANTH	Timer and humidistat control	1



100mm (4") ducting & accessories

Part number	Description	Qty
GDUCT4/3M	3m flexible PVC hose	1
GDUCT4/6M	6m flexible PVC hose	1
GDUCT4/10M	10m flexible PVC hose	1
GDUCT4/15M	15m flexible PVC hose	1
GGRIL4W/B	gravity wall grille (white or brown)	1
GFRIL4W/B	fixed grille (white or brown)	1
GFFGRIL4W/B	fixed wall grille with fly screen (white or brown)	1
GGRIL4CH	100mm (4") chrome effect fixed grille	1



150mm (6") ducting accessories

Part number	Description	Qty
GDUCT6/3M	3m flexible PVC hose	1
GGRIL6W/B	gravity wall grille (white or brown)	1
GFRIL6W/B	150mm (6") fixed grille (white or brown)	1



Efficient
performance
with style



Heating

Warm air

Schneider Electric's range of fixed and portable heaters offer amazing choice and unbeatable value for money. Innovative technical features are included within the specification to promote efficient product performance and style.

Our range extends across hand dryers, bathroom heaters, oil filled radiators, fan heaters and convector heaters.



Features & benefits:

- > Panel heaters offer 3 energy saving modes to suit a range of applications
- > Bathroom downflow heater provides 2 heat setting adjustments for greater comfort
- > Oil filled radiators provide flexible portable heating with a choice of ratings from 700W to 2.5kW
- > Convector heaters provide a secure easy to fit wall mounting option
- > Fan heaters provide an additional solution to space heating
- > Halogen heaters provide radiant electric heat with high efficiency
- > Slimline glass heaters offer stylish design with touch control heating



GSPH1000WS

Panel heaters

- Clear illuminated digital display
- Compact slim line design
- Simple push button temperature control
- Supplied with approximately 1m flex

Standard profile

Part number	Description	Height (mm)	Length (mm)	Qty
GSPH600WW	600W - White	370	589	1
GSPH600WB	600W - Black	370	589	1
GSPH600WS	600W - Silver	370	589	1
GSPH1000WW	1000W - White	370	762	1
GSPH1000WB	1000W - Black	370	762	1
GSPH1000WS	1000W - Silver	370	762	1
GSPH1400WW	1400W - White	370	1049	1
GSPH1400WB	1400W - Black	370	1049	1
GSPH1400WS	1400W - Silver	370	1049	1



GSLPH600WW

Low profile

Part number	Description	Height (mm)	Length (mm)	Qty
GSLPH600WW	600W - White	200	870	1
GSLPH600WB	600W - Black	200	870	1
GSLPH600WS	600W - Silver	200	870	1
GSLPH1000WW	1000W - White	200	1280	1
GSLPH1000WB	1000W - Black	200	1280	1
GSLPH1000WS	1000W - Silver	200	1280	1



HDAC



HDM

Heavy duty hand dryers

- Dimensions: 300mm (L) x 200mm (W) x 165mm (H)
- Adjustable running time 30 or 60 second
- 20.5m/sec air velocity
- 2.17kW loading
- 3 year guarantee
- Thermal safety cut-out
- Drip proof
- Weight - 6kg
- Strong die cast aluminium housing
- Complies with all relevant EMC and low voltage directive
- Approved & certified to safety standard EN 60335-2-23

Part number	Description	Qty
HDM	Heavy duty hand dryer with manual operation	1
HDA	Heavy duty hand dryer with automatic operation	1
HDAC	Heavy duty hand dryer with automatic operation - chrome finish	1



G2BFHP

Downflow bathroom heater

- Dimensions: 230mm (L) x 230mm (W) x 135mm (D)
- Pullcord adjusts heat settings - 1200W & 2kW
- Weight - 1.2kg

Part number	Description	Qty
G2BFHP	2kW heater	1



G20FH5

Oil-filled radiators

- Illuminated control switches
- Fully adjustable thermostat for effective heat control
- Frost guard protection ❄
- Omni-directional castors for ease of use (except on 700W models)
- Integral cable and plug storage facility
- Fitted with approved flex

Part number	Description	Qty
G20FH5	700W mini - silver	1
G20FH5W	700W mini - white	1
G20FH7	1.5kW 7 fin - 3 heat settings (600W, 900W and 1.5kW)	1
G20FH9	2kW 9 fin - 3 heat settings (800W, 1.2kW and 2kW)	1
G20FH9T	2kW 9 fin with timer - 3 heat settings (800W, 1.2kW and 2kW)	1
G20FH11	2.5kW 11 fin - 3 heat settings (1.0kW, 1.5kW and 2.5kW)	1



G2CH

Convective heaters

- All convectors have 3 heat settings – 750W, 1.2kW and 2kW
- Illuminated control switches (optional boost switch on turbo model)
- Fully adjustable thermostat for effective heat control
- Frost guard protection ❄
- Secure wall mounted option (included brackets and fixings)
- Fitted with approved flex
- Dimensions:
 - Free standing 425(H) x 585(W) x 200mm(D)
 - Wall mount 425(H) x 585(W) x 140mm(D)

Part number	Description	Qty
G2CH	2kW with wall mounting options	1
G2CHT	2kW with timer and wall mounting options	1
G2TCH	2kW with turbo and wall mounting options	1
G2TCHT	2kW with turbo, timer and wall mounting options	1



GFHU2

Portable fan heaters

- Resettable thermal cut-out
- Fitted with approved flex
- Frost guard protection ❄

Part number	Description	Qty
GFHU2	2kW upright fan with thermostat - 2 heat settings (1kW and 2kW)	1
G2FHT2	2kW fan with thermostat - 2 heat settings (1kW and 2kW)	1
GFHUF2	2kW upright/flat fan - 2 heat settings (1kW and 2kW)	1



GFHUF2

Halogen heaters

- Radiant electric heat, high efficiency
- Safety tip-over switch, over current protection and safety thermal fuse
- Recessed handle, portable and easy to carry
- Conforms to all relevant safety standards
- For domestic use only

Part number	Description	Qty
G2HAL	1.2kW - 3 heat settings (400W, 800W and 1.2kW oscillating)	1
G3HAL2	800W - 2 heat settings	1



G3HAL2

Technical information



General information

Voltage	220 – 240V 50Hz
Operating frequency	433MHz
Number of channels	5 or 8
Number of unique house codes	256
Operating distance	30 meters
Operating temperature	0°C to + 40°C
Operating humidity	0% to 95%

Receiver termination

Product	Part number	Termination
Ceiling dimmable receiver	GSWCDR35	L & N*
Ceiling relay receiver	GSWCRR5A	L & N*
Floor dimmable receiver	GSWFDR35	L, N, & E
Fluorescent dimmable receiver	GSW10VLDR	L, N, & E

Technical information

Lamp / Load type		Sphere component			
		Dimming			Switching
		Ceiling/Floor dimmable receiver GSWCDR35 GSWFDR35	Wall dimmable receiver GSWWDR30	Fluorescent dimmable receiver GSW10VLDR	Ceiling relay receiver GSWCRR5A
Min/Max loads		Min 20W/VA Max 350W/VA	Min 50VA/60W Max 300W/VA	Max 800W / 4 ballasts	Max 5A (2A motor load) (1)
Low Voltage (12V) halogen lamps	Dimming electronic or magnetic transformer (4)	Y	Y – (trailing edge electronic transformers only)	N	Y – on/off only
Mains GLS / reflector etc, mains (230/240V) halogen lamps (3)		Y	Y	N	Y – on/off only
Linear fluorescent lamps	T8 and high output T5 lamps	N	N	Y (only with 1-10V control electronic ballast)	Y – on/off only
Linear fluorescent lamps	T4 lamps and T5 4-13W lamps	N	N	N	Y – on/off only
Compact fluorescent lamps with separate ballast	4 pin lamps	N	N	Y (only with 1-10V control electronic ballast)	Y – on/off only
CFLi lamps (including those marked 'dimmable')	'Plug-in' Compact fluorescent lamps	N	N	N	Y – on/off only
Light-emitting diode (LED) (Solid state lighting)	Mains voltage lamps	N (2)	N (2)	N	Y – on/off only
Light-emitting diode (LED) (Solid state lighting)	When used with separate driver	N	N	Y (with 1-10V control driver)	Y – on/off only
High intensity discharge lamps		N	N	N	Y – on/off only Max 400W (1)
Other loads: relay, contactor, ceiling fan, wall fan, extractor fan etc.	Motor load	N	N	N	Y – on/off only
Luminaires that already incorporate a dimmer	Father / child up lighter etc	N	N	N	Y – on/off only

Frequently asked questions

Can I have more than one Controller in a room?	Multiple Controllers can be used to control the same lights in a room (e.g. 1 Wall Controller and 1 Handheld Controller). Controllers are added by simply duplicating the Haze, Room and Mode switch settings on each of the additional Controllers. Note if a Controller sends the same command as the previous command sent from another Controller, there will be no response. A second button push will be required. (This is a result of the last Controller command information being held only in the Receivers). One Controller can dim the channels and an alternate Controller can operate scenes. To do this set the dimming/scene switch to 'D' or 'SC' as required.
How do I replace a lost or damaged Controller?	If a Controller is damaged or lost, obtain a replacement and find the record made of the switch settings on the old Controller then duplicate these exactly on the new Controller. Since all the channel and scene settings are stored in the Receivers, no reprogramming is necessary.
Where should I install the Controllers?	Once programming the Receivers has finished, position the Controller(s). As the system is wireless these can be positioned anywhere in the home, taking into account range limitations. A fixed Controller by the door of every room equipped with Sphere will be easy to find when entering or exiting.
What is happening if the lighting seems to change by itself?	Sphere control commands are heavily encrypted. As such unexpected changes to the lighting in one or more rooms can only be caused by Sphere Controllers that have the same switch settings being operated nearby, for instance in adjacent rooms or neighbouring apartments that have the Sphere system. The best way to avoid conflicting operation is to plan the switch settings in advance for all adjacent and nearby systems. However it is still possible that interference could occur if a new Sphere system is installed locally. In this case, the House switch settings on the Controller of the affected room(s) will need altering as follows. (Note that access to the Receivers will be required to press the Receiver buttons during this process).

1. Change the coding of the House switches on the Controller of an affected room by moving one (or more) switch to its alternate position. The associated Receivers will no longer respond. Note that at least one switch needs to be in the up position.
2. Check that the new switch setting does not interfere with other rooms or neighbouring systems.
3. Once a House switch setting has been found that does not interfere with other Sphere systems the channels of the associated Receivers will need to be reassigned as described in the 'System set up' section, page 20, in effect starting a new installation. As long as the Receivers are assigned to the same channels as before, stored scenes will be not be affected.
4. If there are more Controllers for the same room, their switch settings should also be updated. Ensure a note is made of the new switch settings.

Following a period of successful installation and use:

1. If there is no response to Controller commands.
 - a) Check that the mains supply to the installation is still in place, i.e. no MCB's have tripped.
 - b) Check that the controller LED's light when a button is pushed and that the batteries are OK as described on page 36.
 - c) Ensure no room or house switch has been changed inadvertently.
 - d) Ensure there are working lamps running from affected Receivers / in affected channel(s).
 - e) Check the points above, and then gain access to and observe at least one of the Receivers (if installed a Floor Receiver is most convenient) to see if the Receiver LED flashes when the centre button of a Controller is pushed.
 - f) If all checks are OK and the fault still occurs, contact the Helpline, page 43.
2. If any of the lighting loads develop unusual behaviour e.g. flicker or cannot be turned off.
 - a) Check that the relevant connected load is the correct type (pages 34–35).
 - b) Disconnect the supply to the system by tripping the appropriate circuit breaker / removing the circuit fuse, then reconnect the supply by resetting the circuit breaker / replacing the fuse (if in doubt contact a qualified electrician) then operate the system.
 - c) If after carrying out the above the behaviour continues to occur, contact the Helpline, page 41.

If there are any more questions about the Sphere system or how to use it and to find out about updates and more FAQ's, please visit the website www.schneider-electric.co.uk/sphere

Specification				
Description	Switches		Dimmer	
	1-Gang	2-Gang	1-Gang	2-Gang
Safety Compliance	IEC60669-2-1			
Operation	Toggle on/off		Toggle On/ Off/ Adjust lighting intensity	
Memory	Up to 8 Remote Control Units		8 Remote Control Units	
LED Backlight	Changeable Amber / Blue colour		Changeable Amber / Blue colour	
Load Type	Please Refer to Load Table		1. Incandescent 2. Low Volt. Halogen with magnetic transformer Electronic Dimmable 3. Low Volt. Halogen with Ballast dimmable electronic transformer	
Minimum Load	25W		40W per channel	
Maximum Load	Please Refer to Load Table		600W	400w per gang, total 600W for both gangs combined
Operating Temperature	0°C to + 40°C			
Operating Humidity	0% to 95%			
Operating Voltage & Frequency	220-240V AC, 50/60Hz			
Radio Frequency	434MHz			
Mounting Centres 60.3mm	60.3mm			
Dimensions	87mm x 87mm x 39mm			

Load type table

The table below shows the maximum rating for 1-gang and 2-gang switch operating at 220-240V AC

Switch			
Lamp type	1-gang total switch load	2-gang total switch load	
Incandescent lamp	2000W	Max power for one gang	2000W
		Max total power for both gangs added	2000W
Low voltage halogen (12V) with magnetic transformer	1900W	Max power for one gang	1900W
		Max total power for both gangs added	1900W
Low voltage halogen (12V) with electronic transformer	1900W	Max power for one gang	1900W
		Max total power for both gangs added	1900W
Fluorescent lamp with electronic ballast*	1800W	Max power for one gang	1800W
		Max total power for both gangs added	1800W
Fluorescent lamp with magnetic ballast power factor correction capacitor*	1800W	Max power for one gang	1800W
		Max total power for both gangs added	1800W
Fluorescent lamp with magnetic ballast but without power factor correction capacitor*	1000W	Max power for one gang	1000W
		Max total power for both gangs added	1000W
Energy saving lamp*	1400W	Max power for one gang	1400W
		Max total power for both gangs added	1400W
Dimmer			
Lamp type	1-gang total switch load	2-gang total switch load	
Incandescent lamp	600W	Max power for one gang	400W
		Max total power for both gangs added	600W
Low voltage halogen (12V) with magnetic transformer	600VA	Max power for one gang	400VA
		Max total power for both gangs added	600VA
Low voltage halogen (12V) with electronic transformer	600VA	Max power for one gang	400VA
		Max total power for both gangs added	600VA

* Each 0.47uF/275VAC, "X2" bypass capacitor is required to connect parallel to the load in the gang(s) with energy saving lamp or compact fluorescent lamp.

Freelocate		
Product	FreeLocate 2-Setting Switch	FreeLocate 6-Setting Switch
Memory	2 scenes/ 2 devices settings	5 scenes/ 5 devices settings, All Off.
Battery Type	CR2032 button cell battery	
Operating Temperature	0 °C to 40 °C	
Operating Humidity	0% to 95%	
Radio Frequency	434MHz	
Operating Range	100m (Open environment)*	
Dimensions (H) x (W) x (D)	85mm x 85mm x 13mm	

* The performance of the operating range is subject to the actual conditions of the environment, such as weather and installation conditions. Under normal circumstances a longer range can be achieved outdoors, since indoors obstacles like concrete walls and metal shelves may shorten the operating range.

Hand held remote	
Spec/product	Remote controller
Memory	5 scenes/5 devices settings, Master Dim Up/Down and All-Off
Battery Type	2 x AAA batteries
Operating Temperature	0 °C to + 40 °C
Operating Humidity	0% to 95%
Radio Frequency	434MHz
Operating Range	100m (Open environment)*
Dimensions (H) x (W) x (D)	125mm x 51mm x 25mm

* The performance of the operating range is subject to the actual conditions of the environment, such as weather and installation conditions. Under normal circumstances a longer range can be achieved outdoors, since indoors obstacles like concrete walls and metal shelves may shorten the operating range.

Function comparison table			
	FreeLocate 2-	FreeLocate 6-	Remote control
Scene Programming	•	•	•
Device Programming	•	•	•
Disabling Programmed Scene Setting*	•	•	-
Enabling Programmed Scene/Device*	•	•	-
Disabling All-Off Command	-	•	•
Enabling All-Off Command*	•	•	•
Scene/Device Mode Selection (Single Function)	•	•	•
Scene/Device Mode Selection (Multiple Function)*	•	•	•
Changing All-Off Function to Scene Function*	-	•	-
Resume All-Off Function*	-	•	-
Switch/Dimmer Partial Memory Clear	•	•	•

* Only applicable to the Switches and Dimmers of Product No. Starting with U20.

Environment and installation considerations

As the system uses radio frequencies, performance is dependant on the installation. Reliable operation in the following environments can be achieved although the effective range will be reduced by:

- Installation in metal frame buildings or extensions
- Operation through solid or cavity stone, brick or block walls
- Operation through more than one floor, ceiling or partition wall
- Locations near radio or television transmitters
- Damp atmospheres e.g. swimming pools or saunas

If erratic operation is experienced moving closer to the receivers can usually be expected to restore correct operation.

Trouble shooting guide

Symptom	Possible cause	Solution
Switch / Dimmer is not responding to the Remote Control Unit	1. Not previously programmed or improper	Repeat the Programming Procedures explained programming. in the Manual.
	2. Switch/Dimmer is set to Programme mode.	The LED indicator is turned on red now, indicating the unit is in Programming mode. Programme button to exit Programming mode.
	3. Voltage is too low.	Make sure the operating voltage range is within the requirement.
	4. Power rating is too low	Replace a load that meets the minimum loading requirement.
	5. RF wireless control is disabled. (Programme flashes continuously in the pattern of 2)	Press the Programme Button of the LED Switch/ Dimmer 6 times within 1 minute. Programme LED should stop flashing.
Unable to programme.	1. Red Programme LED flashes after the	This indicates the memory is full. Perform Programme Button is pressed. Memory Clearing Procedures to release space.
	2. The Switch does not receive programming	Check the position of the function selector at the commands. back of the FreeLocate Switch. Make sure it is in the Programme position.
	3. RF wireless control is disabled. (Programme flashes continuously in the pattern of 2)	Press the Programme Button of Switch 6 times within 1 minute. Programme LED should stop flashing.
Main light or LED backlight does not turn on.	1. Wires are not properly secured or connected	Make sure the wires are secured, screws are in the terminals. fastened and the Live or Load wires have been connected to the correct terminals.
	2. MCB is OFF or has been tripped.	Switch on the MCB. If a breaker continually trips, contact a registered electrician to find out the cause of the problem
	3. Temporary disorder.	Switch off the MCB and then on again to reset the switch.
Main load is turned off automatically.	1. Power rating is too low.	Replace the load that meets the minimum loading requirement.
	2. Wires are not properly secured in the	Make sure the wires are secured and screws are terminals. Fastened properly.
	3. Controlled by other remote control unit within	Determine which remote control unit(s) is (are) the area. controlling the particular main light. (Refer to Memory Clearing Procedures).
Programme LED flashes continuously in a pattern of 2 for 1 minute then stops. Pattern continues when Control Button is pressed again.	1. Low Volt Halogen (12V) is blown	Replace the lamp load if it is blown, then perform a unit reset.
	2. Magnetic transformer is faulty.	Check the status of magnetic transformer.

Frequently asked questions

Questions	Answers
1. Is two way / intermediate control achievable using ULTI?	Yes. By using a FreeLocate switch
2. What is the purpose of 047uF load capacitor UAX004?	This capacitor should be used for specific lamp types where minimum load requirements are not met
3. What size of mounting box should be used with	A 35mm or deeper back box should be used. ULTI switches and dimmers?

Ease of installation

- Insulation displacement contacts (IDCs) with easy, fast connection using the universal connector tool
- The system is easy to adjust with the test kit; simply check the amplification level and the overall signal level

Scalability

The LexCom Performance VDI system has open interfaces to existing and future applications (wireless, voice over IP, digital video, etc.), thus giving the user complete freedom of choice (some restrictions may apply).
 The standard LexCom Performance solution offers one unit for 8 telecommunication outlets. When greater resources or distribution capacity are needed, simply add a second unit daisy-chained to the first.

Aesthetic and functional integration

The LexCom Performance core unit, attractive and discreet, can be easily integrated into the house, due to:

- Limited space requirements
- Installation on DIN rail very appropriate for modular enclosures
- Attachment to 10" mounting for incorporation in 10" VDI cabinet (supplied by others)
- Side clips for wall mounting or any other horizontal mounting method

Ease of use

- No cross-connection required: once the core unit has been connected to the phone cable end, the TV cable or aerial and the data selector switch, the user can access all supported services from the telecommunication outlets
- Simply connect radios, TV sets, telephones and data applications with the correct cord to one of the 8 predefined links to obtain the desired application
- One of the two phone lines can be selected on each of the links at any time

Satellite TV

LexCom Performance will not transmit feeds from the LNB of a satellite receiver. To achieve the same satellite channel in multiple rooms you must use the RF output on the receiver and connect to RF in on the LexCom Performance unit.

Cable TV

The LexCom Performance system will allow the use of multiple cable receivers within the home. Restrictions to interactive services will apply as the LexCom Performance does not accommodate for return path.

Broadband

With the LexCom Performance system you can have access to a high speed broadband networks that can provide you video, entertainment, online gaming, plus the ability to download music and video. Other opportunities include VoIP (Voice over IP), SOHO (small office, home office), home schooling, and many more.

LexCom Performance core unit

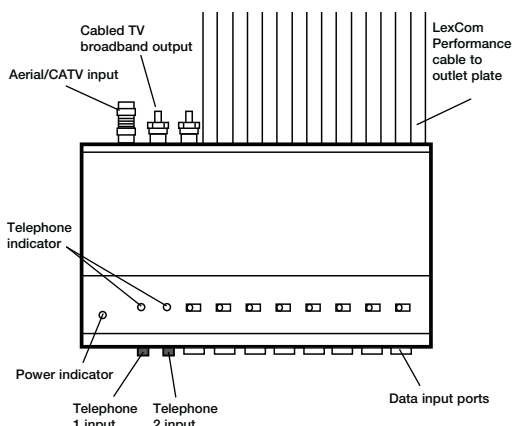

LexCom Performance external view

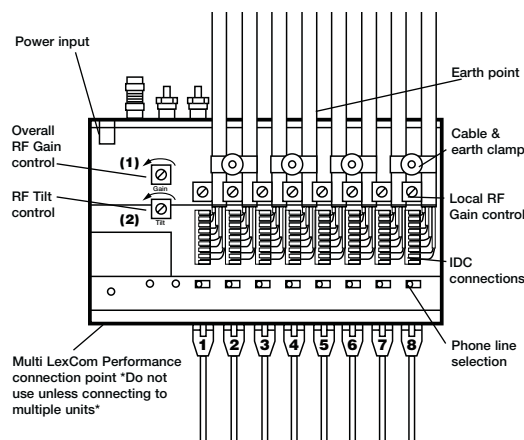

LexCom Performance internal view

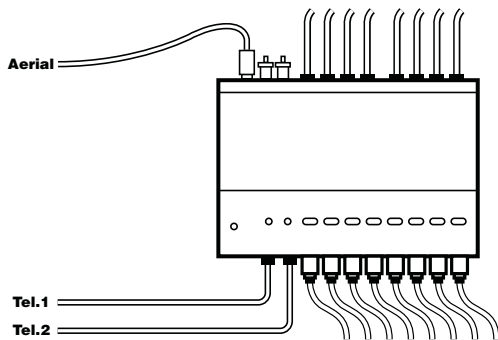

TV/RF input & data

Output will provide:

- A connection to the TV aerial and other RF signals
- Choice between the two phone lines
- Access to the local computer network

Consists of:

- 1 TV aerial connection
- 2 phone lines
- Data switch

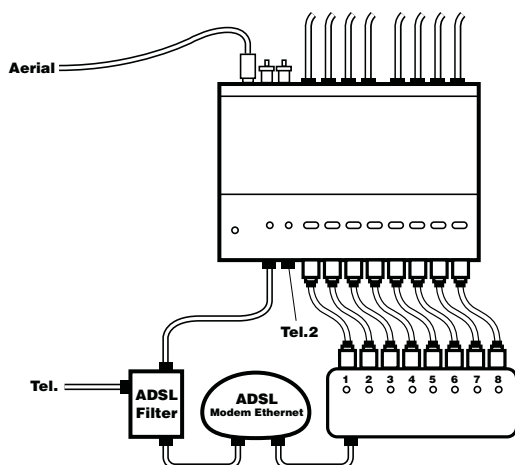

TV/RF input ADSL broadband plus

Output will provide:

- A connection to the TV aerial and other RF signals
- Choice between the two phone lines
- Access to internet

Consists of :

- 1 TV aerial connection
- 2 phone lines
- 1 ADSL filter
- 1 ADSL router/modem
- Data switch if insufficient output ports on router

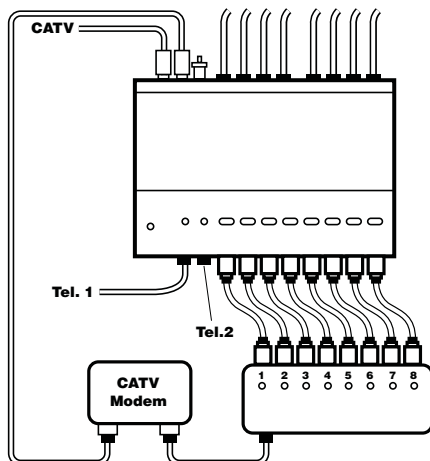

Cable TV and broadband internet configuration

Output will provide:

- A connection to the cable TV
- The choice between the two phone lines
- Access to internet

Consists of :

- 1 CATV connection
- 1 or 2 phone lines
- 1 CATV modem
- Data switch

The active all-in-one module provides the interface for the LexCom Performance system. The incoming services are distributed into the cable links on individual pairs by the dedicated features of the core unit, such as;

- Broadband amplifier for TV/Radio with separate output stages
- Data panel with true cat.6 link performance
- Telephone line splitter with support of 2 different lines (maximum of 4 ren per line)

The system requires LexCom Performance cable in its use to accommodate a link length from 2 to 50 metres.

Below the cover, the links are terminated to the unit, and turning-adjustment of each output stage is done per link to adapt for the lengths. Also global adjustments for Gain and Tilt of the incoming CATV line is possible.

If more than 8 outlets are needed in an installation, 2 or more core units can be daisy chained to achieve 16, 24,..outlets capacity.

The core unit includes power supply and connection cords for the telephone line inputs.

A 4-pair high bandwidth and double shielded installation cable for LexCom Performance applications. It offers Superior shielding with each pair individually shielded in metal foil and the overall tinned copper wire braid (S/STP).

The cable is specifically matching the applications in the LexCom Performance system, using the well known colour coding from LAN installations.

The LexCom Performance installation cable can be used in both surface and flush mounted installations and shows excellent resistance to damage and reduction of performance due to stress from the installation work.

The cable is offered in both 120 m box and 300 m drums, where the box is matching the average cable need for an apartment installation.

Core unit electrical and technical data

Power consumption	14W max
Bandwidth	47-862 MHz (CATV on all links)
Gain forward	Global = -5 / +15 dB
Tilt (equalizer)	Global = + / - 6 dB
Input level	60-77 dBµV (CATV RF input)
Return loss	-10 dB min. (CATV RF input)
Insertion loss	RF input to DATA = 4 dB
	RF input to TEST = 10 dB
	DATA to RF input = 4 dB
Screening attenuation	> 90 dB (class A)
Impedance input	75 Ohm (CATV RF input)
Input voltage	12 Vdc

Construction and material data

Input interface	Tele lines: 2 x RJ11
	Data ports: 8 x RJ45 STP
	CATV RF: F-conn. (fe-male)
	Security line: RJ3 1X
Output interface	Power supply: 5.5mm jack (+ on centre)
	Cable links: LSA punch down (TIA568B)
	CATV test: F-conn. (fe-male)
	CATV data: F-conn. (fe-male)

Standards and approvals

Application standard	EN50083-2: emission and immunity
Cabling standards	EN50173:2002 Cat.6 PL

Installation cable electrical and technical data

Attenuation	47 dB @ 600 MHz / 100 meter
Bandwidth	0 - 900 MHz
Impedance	100 Ohm nom.
NEXT	93 dB @ 100MHz
	80 dB @ 300 MHz
	75 dB @ 600 MHz
Signal Velocity	0.8 c
Bending radius under installation	Min. 65 mm.
Bending radius Installed	Min. 30 mm.
Temperature, Installation	0 °C to +50 °C
Temperature, Operation	-20 °C to +60 °C

Construction and material data

Material	LSFROH
Weight	55 kg/km
Printing	Home installation cable 2x4xAWG23 SSTP
Calorific Value	0.55 MJ/m
Cable Ø	7.1 mm
Colour: conductor	White/Blue, white/orange, white/green, white/brown
Colour: sheath	White RAL 9010

Standards and approvals

Absence of halogens	ISO 60754-2
Flame Retardance	ISO 60332-1 / -3
Application standard	EN 50173-1
Cable standards	EN 50288-5-1
Application standard	ISO 11801

Trouble shooting	Recommendations and installation
Telephone Connections	For all telephone connections, you have to use a two wire line adaptor in order to avoid any short circuit or non-functioning of other services (TV & data).
Security Input	Do not use the Security Input unless used with the stacking cord. Failure to do so will cause permanent damage of line one.
Non-functioning telephone	If the telephone line 1 does not work, but that the telephone line 2 still works, the line 1 could have been damaged by the RJ11 plug connected in the security socket. If it is the case, please contact Schneider Electric Ltd.
PABX	Where a PABX is in use, you must use 1Pair telephone cord between the PABX and line 1 or line 2. If the PABX requires more than 1Pair, it will not be compliant with the LexCom Performance system with the potential risk of damaging the PABX.
Noise on the telephone line 1 or line 2	If noise on the telephone line 1 or 2, check the system : * without the ADSL filter, * by plugging directly the telephone on the telephone line from the operator (disconnection of the LexCom Performance). If no noise occurs when doing these operations separately, the problem should come from the mismatch impedance between the used telephone and the LexCom Performance.
Poor TV picture	Adjust Gain and Tilt to improve signal
Poor/No TV signal using triple play	Ensure the correct input cable is used from wall outlet plate to triple play
Data/broadband cable	The dedicated LexCom Performance cables must be used for all data and broadband services
Data input to LexCom Performance	Cat 5, Cat 5E, Cat 6 or dedicated LexCom Performance cables can be used as inputs
Frequently asked questions	Answers
Can I distribute HDMI over LexCom Performance?	LexCom Performance will distribute RF television, data and telephone
What is the minimum and maximum single length I can run LexCom Performance cable?	min. 2m, max. 50m
Can I use Cat. 5 or Cat. 6 cable?	No, bandwidth is insufficient on Cat. 5 and Cat. 6 cable
Is it possible to receive more than one signal from one outlet?	Yes. Incorporating a Tripleplay splitter enables you to connect to TV, Data and telephone at one LexCom Performance outlet.
Do I need to run 3 cables to each wall outlet?	One of the many advantages of LexCom Performance is that you only need to run one cable to each LexCom Performance outlet
Can I have infra-red control over my equipment?	Yes, by using a separate RF to IR Converter (available separately from retail outlets)
Can I distribute cable or satellite broadcast?	LexCom Performance will not transmit feeds from the LNB of a satellite receiver. To achieve the same satellite channel in multiple rooms you must use the RF output on the receiver and connect to RF in on the LexCom Performance unit.
	The LexCom Performance system will allow the use of multiple cable receivers within the home. Restrictions to interactive services will apply as the LexCom Performance does not accommodate for return path.
	With the LexCom Performance system you can have access to a high speed broadband networks that can provide you video, entertainment, online gaming, plus the ability to download music and video. Other opportunities include VoIP (Voice over IP), SOHO (small office, home office), home schooling, and many more.

Recommended quantity of socket outlets for domestic installation

Inadequate installations can occur when not enough socket outlets have been installed or where the existing sockets are located in the wrong areas. This could lead to potentially dangerous improvisations.

The table below summarises the recommendations of the Electrical Installation Industry Liaison Committee (EILLC) regarding the minimum number of twin switched socket outlets per room, suitable for domestic installations. This takes into account likely uses and likely trends.

Room	Number of sockets	Room	Number of sockets
Kitchen	4	Landing/stairs	1
Lounge	6	Hall	1
Dining room	3	Garage	2
Double bedroom	3	Store/workroom	1
Single bed-sitting room	3	Central heating boiler point	1

Wiring circuits for 6AX and 10AX switches

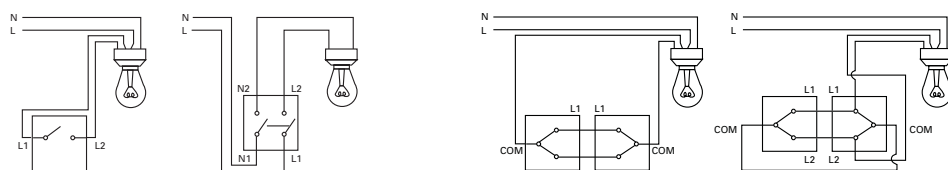

Diagram A - One way circuits

Diagram B - Two way circuits

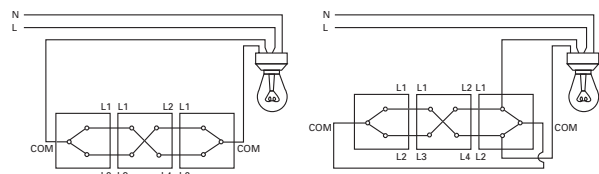

Diagram C - Intermediate circuits

Note: 1 way or 2 way switches can be replaced by dimmer switches. Rotary dimmers are 1 way only whilst Push dimmers are 2 way. LV dimmers are suitable for use on the LV input side only.

Accessories mounting box

Product	Description	Ultimate white moulded	Exclusive white moulded	Ultimate flat plate	Rocca decorative	Exclusive brass and metal plate
6AX/10AX plate switches	1-2 gang	16mm	16mm	16mm	25mm	25mm
	3 gang	25mm	25mm	25mm	25mm	25mm
	4-6 gang	25mm	25mm	25mm		25mm
	TP isolator	25mm	25mm	25mm		25mm
Dimmer switches	1 & 2 gang	**16mm/25mm	**16mm/25mm	25mm	35mm	25mm
	3 & 4 gang	25mm	25mm	25mm		25mm
Socket outlets	1 gang	25mm*/35mm	25mm	25mm*/35mm	25mm	25mm
	2 gang	25mm*/35mm	25mm	25mm*/35mm	25mm	25mm
	3 gang		25mm			
Round pin sockets		25mm	25mm	25mm		25mm
RCD socket outlets	1 & 2 gang		25mm			25mm
Fused connection units		25mm	25mm	35mm	35mm	25mm
Flex outlet plates		25mm	25mm			
20AX key switches		25mm	25mm	25mm	35mm	25mm
20AX DP switches		25mm	25mm	25mm	35mm	25mm
32A DP plate switches	1 gang	47mm	47mm			47mm
	2 gang	47mm	47mm	47mm	47mm	
45A DP switches	1 gang	47mm	47mm			47mm
	2 gang	47mm	47mm	47mm	47mm	
45A DP ceiling switch			47mm			
Cooker connection units		47mm	47mm	47mm		47mm
Cooker terminal box		47mm	47mm			
Shaver sockets		47mm	47mm			47mm
Telephone socket outlets	Master & secondary	25mm	25mm	25mm	25mm	25mm
Co-axial socket outlets	Single & twin	25mm	25mm	25mm	25mm	25mm
Diplex and triplex		25mm	25mm	35mm	25mm	25mm
Satellite socket		25mm	25mm	25mm		25mm
RJ45 & RJ11		35mm	35mm	35mm	35mm	35mm

Note: Metal clad accessories are supplied complete with a 42mm surface mounted box in the same matching finish. Metal plate accessories are not suitable for mounting on surface moulded pattresses.

*Dependent upon wiring configuration

**For 16mm flush fitted steel boxes use adaptor plate supplied when mounting 2 Way Ultimate slim line moulded dimmer switches

Dimmer switches

General Information:

When specifying dimmers it is advisable to obtain as much information as possible to ensure suitability and compatibility of products. Consider the following:

- Type of lamps/lighting
- Type of control gear used in the light fittings, (if applicable) e.g. type, make and model number of transformer or ballast, etc
- Number of light fittings/load of each dimmer
- Number of circuits/dimmers
- Number of dimmers on each plate
- Number of switching positions for each circuit
- Any requirement for dimming lights from more than one position

1 gang plate size

Dimmer modules	Max.each dimmer	Min.each dimmer	Total per plate
1	250W	60W	250W
1	400W	60W	400W
1 (Electronic)	300VA	60VA	350VA
2	250W	60W	500W
2 (Electronic)	200VA	60VA	400VA

Maximum load of 400W for the plate should not be exceeded.

Dimmer modules	Max.each dimmer	Min.each dimmer	Total per plate
1	1000W	100W	1000W
3	250W	60W	750W
4	250W	60W	1000W

Maximum load of 1000W for the plate should not be exceeded.

GET mains dimmers are NOT designed for dimming with any form of Low Voltage transformer. For this application a suitably rated Low Voltage Dimmer Switch should be used.

Maximum permitted loads in Watts for multiple dimmers in a single enclosure

Front plate gang size	2	3	4	6	8	9	12	18	24
Per row (max rating W)	400	480	480	480	480	480	480	480	480
Total plate (max rating W)	400	480	480	740	740	940	940	1440	1800

GET dimmer guidelines

Moulded plate mounted dimmers can generally be used with the supplied pattress to replace standard wall switches (where a 16mm box depth is typically used). For flat plate mounted dimmers, 25mm boxes are required, except for the 1000W Electronic dimmer that requires a 47mm box. All rotary dimmer terminations and wiring are the same as for standard switches, i.e. COM, L2 (and also L1 for two-way dimmers).

Rotary one-way dimmers can only be used for switching and dimming from one position. Rotary two-way (push) dimmers can be used to replace any one, (but not both), of the two-way switch circuit, (note that only one dimmer can be used per switch circuit or lamp(s); thus the lights can be switched from more than one position but can only be dimmed from one. With any rotary dimmer, if replacing an existing switch or dimmer, make a careful note of which wires are installed in which terminals on the old unit, and then connect them into the terminals with corresponding markings on the new dimmer. To ensure that plate temperatures are within maximum limits, maximum total connected load for a single size plate is 630W, and for a double size plate is 1000W. For Low Voltage lighting, remember to allow for transformer losses when calculating the total circuit load, typically 15% - 20%.

To use electronic dimmers in 1, 2 or more way circuits the circuit diagrams below and the Important Notes MUST be followed exactly.

1 way installation wiring diagram

IMPORTANT NOTES - for 1 Way Installation

1. Read General Installation Safety Instructions before starting work
2. Do not connect any conductor to dimmer terminal marked RS. This is for use with 2 way switching

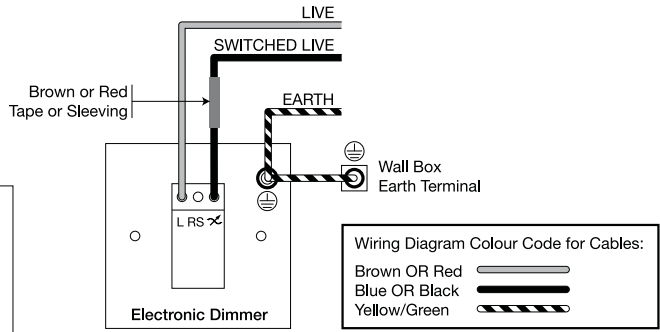

2 way and multi-way installation wiring diagram

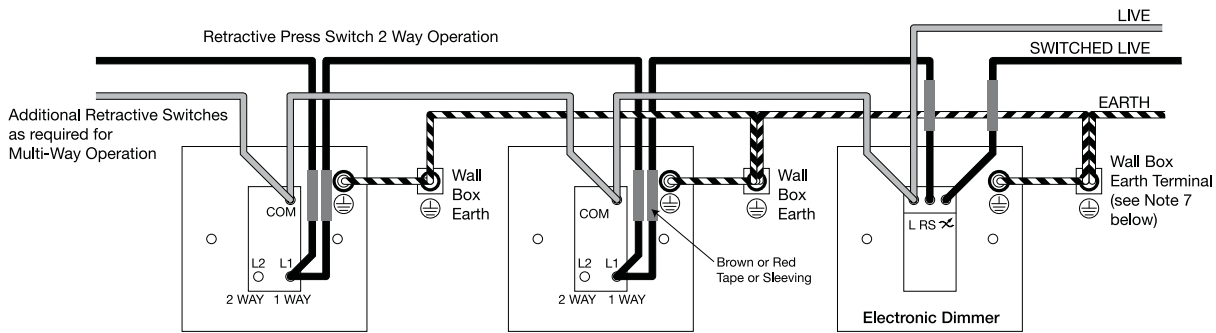

Important notes - for two way and multi - way installation

1. Read General Installation Safety Instructions before starting work.
2. Any existing 2 Way or Intermediate switches MUST be replaced with Retractive Press Switches.
3. Any number of Retractive Press Switches may be installed provided total cable length does not exceed 50m.
4. Either 1 Way normally open or 2 Way Retractive Push Switches may be used.
5. If 2 Way retractive switches are used, connect to Common (COM) and normally open L1 (1 WAY) terminals as shown. Do NOT use the L2 (2 WAY) terminal.
6. If replacing an existing 2 Way switch, cut back and insulate the unused 2 way wire previously connected to the L2 (2 way) terminal.
7. All Metal Wall Boxes and Metal Plate Switches must be earthed.
8. Do NOT connect more than 1 Dimmer in the same circuit,
9. Remove label covering centre terminal on rear of dimmer. This terminal is to be connected to Retractive Switch as shown in wiring diagram. Do NOT connect any other conductor to this terminal.

Circuit, lamp and other equipment compatibility

To ensure optimum performance and reliability is obtained from dimmer switches the following recommendations and precautions should be followed as appropriate to the type of dimmer:

General recommendations

Circuits

It is recommended that all lighting circuits incorporating dimmers be protected by a 6A or up to a 10A maximum Type B miniature circuit breaker.

Tungsten halogen lamps

When using mains voltage Tungsten Halogen lamps, it is essential that these types of lamp incorporate internal fuses or are constructed such that arcing at the end of life cannot occur and are from quality lamp manufacturers. The use of inferior low quality lamps is not recommended and will invalidate any guarantee or warranty supplied with the dimmer switch.

Dimmable low voltage transformers

- Always check transformer compatibility BEFORE installation and if in doubt always check with the dimmer Helpline or the transformer manufacturer. It is recommended that electronic dimmable transformers be loaded to at least 70% of their rated maximum wattage.
- When running multiple lamps on dimmable electronic transformers ensure that all lamps are working correctly. Replace failed lamps as soon as possible as a single failed lamp may cause flickering of all other lamps connected to the same dimmer.
- Do NOT mix electronic and magnetic transformers on the same dimmer switch.
- It is recommended that a maximum number of 5 Low Voltage transformers only should be connected to an individual dimmer switch.

Electronic dimmers

Circuits

- For two-way or more switching ONLY use retractive switches. Do NOT use two-way switches.

- The live supply for retractive switches must come from the live (L) connection of the dimmer.
- The dimmer must be connected at the live supply end of multiway installations.

Lamps

- Do NOT use with Compact Fluorescent Lamps (CFL) even if marked "dimnable", Fluorescent lamps and Light Emitting Diode (LED) lamps of any description or motor loads.

Dimmable low voltage transformers

- These Electronic dimmer switches, except the 1kW, use leading edge (phase delay) dimming technology and must therefore be used with compatible good quality dimmable electronic or wire-wound (magnetic) transformers. Trailing edge (phase cut) dimmable transformers must not be used.
- The 1kW dimmer switch uses trailing edge (phase cut) dimming technology and must therefore be used with compatible good quality dimmable electronic transformers. Do not use the 1kW dimmer with magnetic transformers.

Rotary and 2 way (push) dimmers

Circuits

- Only use two-way (push) dimmers in two-way switching circuits. Only use one two-way dimmer in a two-way switching circuit.

Lamps

- These dimmer switches are suitable for dimming incandescent lamps and dimmable CFL lamps only and are NOT to be used with Fluorescent lamps, Light Emitting Diode (LED) lamps of any description or motor loads. Use of non-dimmable CFL lamps may permanently damage the dimmer or the lamp and will invalidate any guarantee or warranty supplied with the dimmer switch.
- It is recommended that a maximum number of 5 dimming CFL lamps only should be connected to an individual dimmer switch.

Dimmable low voltage transformers

- Only use Low Voltage dimmers with transformers. Do not use mains voltage dimmers.
- The Low Voltage dimmer switches use leading edge (phase delay) dimming technology and must therefore be used with compatible good quality dimmable electronic or wire-wound transformers. Trailing edge (phase cut) dimmable transformers must not be used.

Co-Axial and Satellite sockets

Non isolated

Non-isolated products are intended for direct connection to a single or two separate TV/FM aerial downloads. These units are not designed for use in multi outlet systems.

Single TV/FM outlet for connection to a single TV or FM coaxial aerial lead.

Twin outlet for connection to each of two separate TV/FM, coaxial aerial leads.

Diplex and Triplex

Performance

Diplex

TV/FM diplex units for connection to a single coaxial aerial lead with combined TV and FM signals.

The connector standard IEC 169-2 plug for TV and IEC 169-2 socket for Radio.

Triplex

TV/FM/SAT triplex unit for connection to a single coaxial aerial lead with combined TV, FM and satellite signals.

TV: 470-860MHZ

Radio: (FM) 87.5 – 108 MHz and (DAB) 217.5 – 230 MHz.

Satellite: DC – 200kHz and 950-2300MHz.

The connector standard is 'f' for satellite, IEC 169-2 plug for TV and IEC 169-2 socket for Radio.

Telephone socket outlets

It is legal for a contractor to install a secondary telephone socket with associated wiring into house-holds with single exchange lines. The contractor may install a secondary socket and wire up to the master socket and wiring to the exchange. This does not include wiring the actual master socket or to the exchange itself. this final connection must be made by an approved installer.

For commercial and industrial installations a PBX (or PABX) internal exchange or 'intelligent' telephones are often fitted. In this case, the contractor may install all of the equipment except for the PBX unit installation. Again this must be carried out by a BSI approved installer and the interface between the PBX/PABX internal system and the incoming external lines must be connected by British Telecom.

GET telephone sockets are suitable for use in accordance with BS 7671, formerly the 16th Edition of the IEE Wiring regulations and should be wired in accordance with the diagrams shown.

Example of typical connection

1 Connection to 2 & 5

2 Earth recall (when used) connect to terminal 4

3 Connection to terminal 3 is not usually required

NB (a) Standard 4 wire cable is shown below as incoming cable. If terminals 1 and 6 (normally unused) are required, 6 wire cable may be used.

(b) All socket outlet connections are parallel – any number of socket outlets can be connected, but it is recommended that only a maximum of 5 telephones be used at any one time on one line.

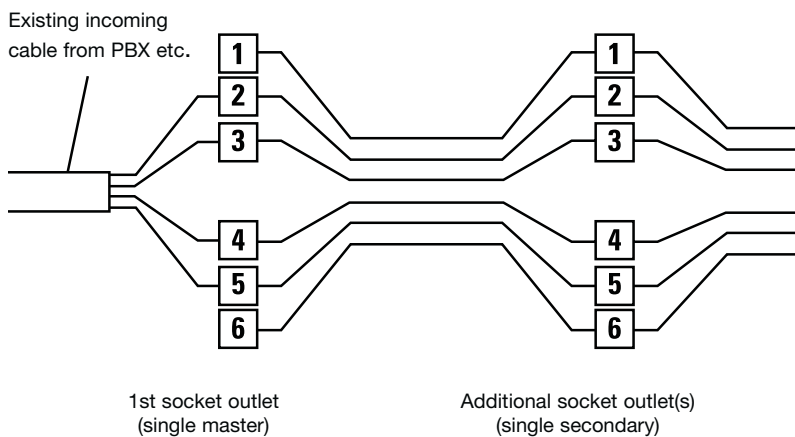

Product Type (Colour)	All mounting enclosures (ie back box)	Grey transparent covers and plugs	Resistant orange (RO) covers and plug s
Acids			
Weak Solutions			
Hydrochloric	A	A	A
Nitric 10% Concentrate	A	A	A
Sulphuric Acid 100%	A	D	D
Alkalis			
Weak Solutions			
Sodium Hydroxide 10% (Caustic Soda) Concentrate	A	D	B
Potassuim Hydroxide 100%	A-B	D	D
Automotive			
Petroleum	A	D	A
Lubricating Oils		D	A
Hydraulic Oil		D	A
Solvents			
Aliphatic hydrocarbons (alkanes)			
Methane	B	A	A
Propane	A	A	A
Alcohols			
Ethelene Glycol	A	A	A
Glycerol (Glycerin)	A	C	B
Methyl Alcohol (Methanol)	A	D	B
Ethyl Alcohol (Ethanol)	A	A	A
Amines			
Aniline	D	D	D
Aromatic Hydrocarbons			
Methyl Benzene	D	D	B
Xylene	D	D	B
Ethers			
Dimethyl Ethyl	A	A	A
Ketones			
Acetone	A	D	C
Acetophenone	D	D	C
Ethyl Methyl Ketone	D	D	C
Miscellaneous			
Detergent	A	A	A
Inorganic Salts			
Magnesium Sulphate	A	A	A
Oxidising agents			
Weak Solution			
Sodium Hydrochlorite 5%	A	A	A
Strong Solution			
Hydrogen Peroxide 30%	A	A	A
Water			
Ambient	A	A	A
Hot >60°C	C	A	B
Steam	D	D	D

This table should be used as a guide only. Any end user should test to evaluate the suitability of any chemical with any plastic.







A - Excellent
Recommended no
adverse effects after
extended exposure.

B - Good
Acceptable minimal loss
of mechanical properties
after long periods of
exposure.

C - Fair
Marginal acceptability.

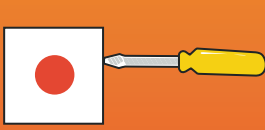





D - Poor
Not recommended for
use.

PROTECTION AGAINST SOLIDS

	TEST	PROTECTION
X	No test applied	No specific protection
0	No test applied	Inherent degree of protection
1		Protected against solid objects equal to or greater than 50mm diameter. (eg. accidental contact with hand)
2		Protected against solid objects equal to or greater than 12.5mm diameter. (eg. contact with finger)
3		Protected against solid objects equal to or greater than 2.5mm diameter. (eg. tools and wires)
4		Protected against solid objects equal to or greater than 1mm diameter. (eg. fine tools and wires)
5		Protected against quantities of dust that could interfere with satisfactory operation.
6		Completely protected against dust.

Defined by IEC 60529
DIN 40050 CEI 70-1

PROTECTION AGAINST LIQUIDS

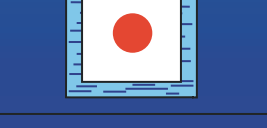
	TEST	PROTECTION
X	No test applied	No specific protection
0	No test applied	Inherent degree of protection
1		Protected against drops of water falling vertically.
2		Protected against drops of water falling at up to 15 degrees from the vertical.
3		Protected against spraying water at up to 60 degrees from the vertical.
4		Protected against splashing water from all directions.
5		Protected against jets of water from all directions.
6		Protected against jets of water of similar force to heavy seas.
7		Protected against the effects of temporary immersion.
8		Protected against the effects of continuous immersion.

Defined by IEC 60529

	Ceiling Mounted				
Product Code	SAEUEMSCUWE	SAEUEMSCSAWE	SAEUEMSCDBWE	E751	
Product Description	Single-Load 360° PIR and Ultrasonic Sensor	Single-Load 360° PIR Sensor	Dual-Load 360° PIR Sensor	Infrascan single-load 120° PIR sensor	
Operating voltage	230V 50/60Hz	230V 50/60Hz	230V 50/60Hz	200-265V 50Hz	
Field of view	360°	360°	360°	120°	
Range	12m×18m at 2.5m height	7m at 2.5m height	7m at 2.5m height	6m x 6m, 8.5m from sensor head. Head rotatable through 120°	
Mounting	Ceiling (surface / flush)	Ceiling (surface / flush)	Ceiling (flush)	Ceiling (surface)	
Single or Dual Load:	Single	Single	Dual	Single	
IR Remote Control*	SAEUEMSIR10T	X	X	X	
Incandescent	2000W	2000W	2000W	2A	
Halogen lamps 230V	1000W	1000W	1000W	2A	
Halogen w. Electronic transformer	1000VA	1000VA	1000VA	2A (iron core transformer only)	
Fluorescent tubes	900VA/100µF	900VA/100µF	900VA/100µF	X	
Energy Saving lamps	900VA	900VA	900VA	X	
IP class	IP20	IPX0	sensor IP40 , power box IP20	IP44	
Time setting	Time 1 (for lighting): Adjustable from 5 sec to 20 min Time 2 (for HVAC): Adjustable from 10 sec to 60 min	5 sec to 20 min	Time 1 (for lighting): Adjustable from 5 sec to 20 min Time 2 (for HVAC): Adjustable from 10 sec to 60 min	5 sec to 20 min (user adjustable)	
Test Mode	Yes	Yes	Yes	Yes	
Lux setting	10 - 2000 Lux	10 - 2000 Lux	10 - 2000 Lux	Continuous from 1 Lux to full sunlight	
Operating temp range	0°C to +50°C	0°C to +45°C	0°C to +45°C	0°C to +40°C	
Connection	3-wires	3-wires	3-wires	2 wires	
Parallel connection of detectors	Yes	Yes	Yes	No	
Switching modes	Auto/Off	Manual on	X	Auto mode, manual override	
Product Dimensions	Ø111.5 x 72mm Ø111.5 x 43.5mm (flush) 68mmØ Cut-out	Ø111.5 x 59mm Ø111.5 x 30mm (flush) 65mmØ Cut-out	Ø80 x 16.5mm(H) 65mmØ Cut-out	Ø 100 x 57mm(H)	

	Wall Mounted		Outdoor			
	E751R	GUPA1411BSS	GUP1411BSS	E750WPRGY	CCT56P004	CCT56P008
	Infrascan Single-load 120° PIR sensor	Ultimate screwless 90° PIR plate switch - with override	Ultimate screwless 90° PIR plate switch	Infrascan single-load 110° PIR sensor	Single-load 120° PIR sensor	Single-load 360° PIR sensor
	200-265V 50Hz	230V 50Hz	230V 50Hz	200-265V 50Hz	220-240V 50Hz	220-240V 50Hz
	120°	90°	90°	110°	120°	360°
	6m x 6m, 8.5m from sensor head. Head rotatable through 120°	5m at 1.2m height	5m at 1.2m height	18m at 2.4m height	12m (forward)	12m
	Ceiling (surface)	Wall (flush)	Wall (flush)	Wall or ceiling (surface)	Wall or ceiling (surface)	Wall or ceiling (surface)
	Single	Single	Single	Single	Single	Single
	X	X	X	X	X	X
	10A	150W	150W	10A	1000W	1000W
	10A	150W	150W	10A	900W	800W
	10A	150VA	150VA	10A	250VA	315VA
	10A	X	X	10A	200VA	250VA
	500W	X	X	500W	4 x 23W	4 x 23W
	IP44	X	X	IP66	IP55	IP55
	5 sec to 20 min (user adjustable)	15 sec – 30 min (through 7 time increments)	15 sec – 30 min (through 7 time increments)	5 sec to 20 min (user adjustable)	Approx 3 sec – 3 min, lower tolerance 2 – 6s	Approx 5 sec – 20 min, lower tolerance 2 – 8s
	Yes	No	No	Yes	Yes	Yes
	Continuous from 1 Lux to full sunlight	10 - 2000 Lux	10 - 2000 Lux	Continuous from 1 Lux to full sunlight	5 – 2000 Lux	5 – 2000 Lux
	0°C to +40°C	+5°C to +25°C	+5°C to +25°C	0°C to +50°C	-15°C to +40°C	-15°C to +40°C
	3-wires	2 wires	2 wires	3-wires	3-wires	3-wires
	Yes	Yes	Yes	Yes	Yes	Yes
	Auto mode, manual override	Auto mode, manual override	X	Auto mode, manual override	Auto mode, manual override	Auto mode, manual override
	Ø 100 x 57mm(H)	88 x 88mm	88 x 88mm	Mounting centres 84mm	With corner bracket 164mm (L) x 80mm (W) x 75mm (H) without corner brackets 140mm (L) x 80mm (W) x 75mm (H)	With corner bracket 170mm (L) x 88mm (W) x 76mm (H) without corner bracket 142.5mm (L) x 88mm (W) x 76mm (H)

Lighting range standards

	Mains halogen downlighters	Low voltage dichroic downlighters	Low voltage cabinet lights
Operating voltage	230/240V AC 50Hz	12V AC 50Hz	12V AC 50Hz
Max lamp rating	50W	50W	20W
Standard compliance	EN 60598-1:1997	EN 60598-1:1997	EN 60598-1:1997
Lamp type	GU10 closed halogen ES50	MR16 dichroic closed type	G4 capsule lamp
	CE □	CE	CE

Beam diagrams

Halogen lamps (mains)

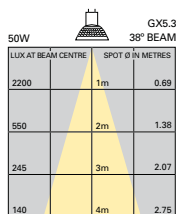

MR16 dichroic lamps (low voltage)

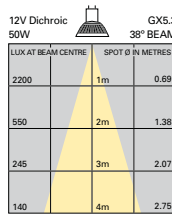
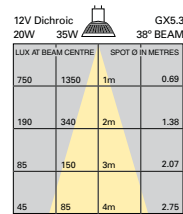

Electronic transformer data

Model	65VA		105VA		150VA		200VA	
	GTR65P	GTR65	GTR105P	GTR105	GTR150P	GTR150	GTR200P	GTR200
Primary (V)	230-240V		230-240V		230-240V		230-240V	
Secondary (V)	11.4 - 11.6V		11.4 - 11.6V		11.4 - 11.6V		11.4 - 11.6V	
Power	65VA		105VA		150VA		200VA	
Output (Hz)	40KHz - 43KHz		40KHz - 43KHz		40KHz - 43KHz		40KHz - 43KHz	
Current (A)	5.4A		8.8A		13A		17.4A	
LED Indicator	Yes	No	Yes	No	Yes	No	Yes	No
Output wires	2 x 300mm silicon insulated		2 Pairs		4 Pairs		4 Pairs	
Short Circuit Protection	Manual Reset	Auto Reset	Manual Reset	Auto Reset	Manual Reset	Auto Reset	Manual Reset	Auto Reset
Overload Protection	Manual Reset	Auto Reset	Manual Reset	Auto Reset	Manual Reset	Auto Reset	Manual Reset	Auto Reset
Thermal Protection	Resettable	Yes	Resettable	Yes	Resettable	Yes	Resettable	Yes
Max Case Temp	85°C		85°C		85°C		85°C	
Power Factor	0.98		0.98		0.98		0.98	
Cable Size max.	1.5mm ²		1.5mm ²		1.5mm ²		1.5mm ²	
Max Dimensions	124mm x 30mm x 40mm		147mm x 30mm x 40mm		206mm x 44mm x 56mm		206mm x 44mm x 56mm	
Case material	Polycarbonate UL94 V0		Polycarbonate UL94 V0		Polycarbonate UL94 V0		Polycarbonate UL94 V0	
Weight	107g	97g	121g	112g	280g	270g	300g	290g
Guarantee	10 Years	5 Years	10 Years	5 Years	10 Years	5 Years	10 Years	5 Years

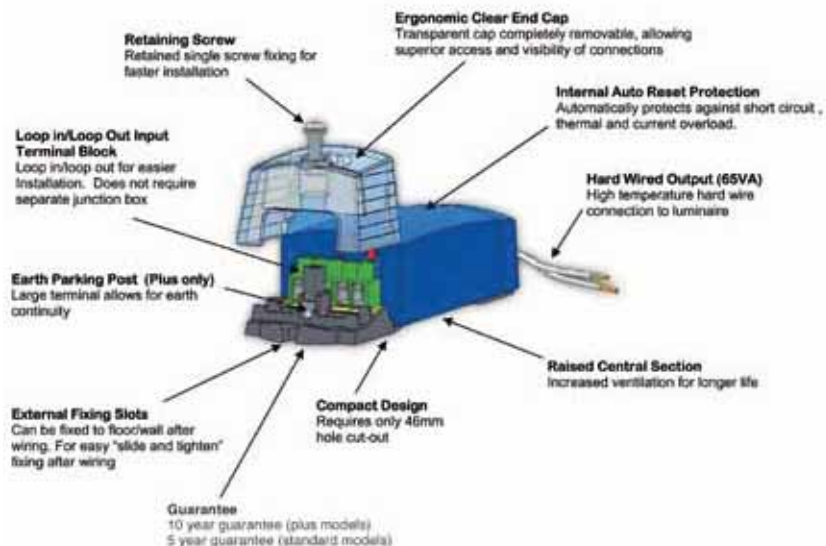
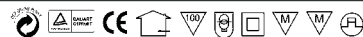

Ingress protection system

EN 60529

The resistive performance of fittings to solids and liquids is indicated by the IP (Ingress Protection) prefix followed by two numbers. The first number indicates the measure of protection against the ingress of solids.

The second number indicates the measure of protection against the ingress of liquids.

Protection against the ingress of solids

First identification number

Number	Measure of protection	Test
IP2X	Against foreign bodies > 12mm Ø	Ball 12mm Ø and finger test
IP3X	Against foreign bodies > 2.5mm Ø	Steel wire 2.5mm Ø
IP4X	Against foreign bodies > 1.0mm Ø	Steel wire 1.0mm Ø
IP5X	Against harmful dust deposits (dust proof)	Talcum powder – particles 1 µm Ø
IP6X	Against any entry of dust (dust light)	Talcum powder – particles 1 µm Ø

Protection against the ingress of liquids

Second identification number

Number	Measure of protection	Test
IPX1	Against falling drops of water	Water falling vertically
IPX2	Against falling drops of water	Water falling up to 15° from vertical
IPX3	Against falling drops of water (rain proof)	Water falling up to 60° from vertical
IPX4	Against splashed water (splash proof)	Water from all directions
IPX5	Against jets of water (jet proof)	Water from all directions projected by a nozzle
IPX6	Against heavy seas or powerful water jets	Water from all directions projected by a nozzle
IPX7	Against prolonged immersion effects, but not for continuous underwater application	Immersion in water > 1m for 30 minutes
IPX8	Against prolonged submersion	Immersion in water > 1m max for 30 minutes – max. depth tested indicated after symbol (pressure water-tight)

Current-using equipment and accessories in locations containing a bath or shower

These illustrations and the advice opposite are based on BS 7671:2008 the IEE Wiring Regulations 17th Edition, Section 701. For full details please look in this document. For lighting installed in Zone 1 and 2 all luminaires must be at least IPX4, or IPX5 if water jets are used for cleaning. All circuits for current-using equipment and accessories must be protected by RCD's of 30mA rating. SELV (12V ac) luminaires must have the SELV source (transformer) outside the zones e.g. in the ceiling void.

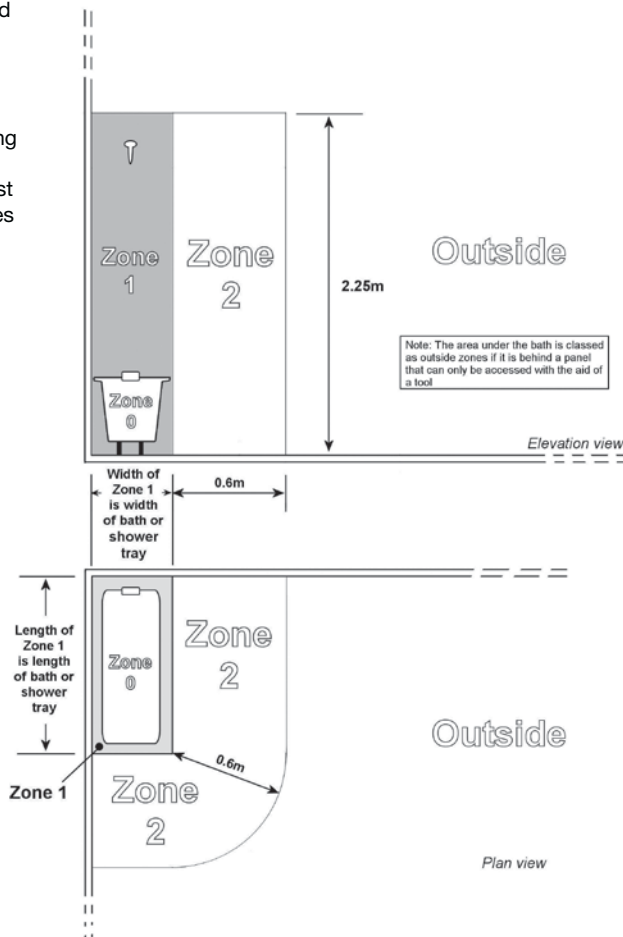

Light and colour rendering

The colour appearance will depend on the spectral emission of the light source and the ability of a light source to render colours naturally, without distorting the hues. An even balance of light and colour define the atmosphere of a room and by the warmth or coldness influences a persons mood.

The colour characteristics of a lamp are governed by two separate criteria: colour appearance and colour rendering.

Colour temperature

The colour appearance of a light source characterised by the colour temperature Kelvin (K), the higher the temperature of the lamp the whiter its light.

Colour rendering

The effect that Fluorescent and other types of lamp have on the appearance of coloured objects is indicated by the general colour rendering index (Ra) scale of eight standard test colours.

Measured on a scale of 0 to 100, where 100 is the equivalent of daylight, higher values indicate better colour rendering. Values of 100-90 are very good, 90-80 good and those below 80 should not be used where colour rendering is a key factor.

LUX (lux)

The amount of light falling on a surface. Offices are typically lit to between 600 and 800 lux at desktop height.

1 Lux = One lumen per square metre, unit of illuminance.

Lamp types

Tungsten halogen

This light source is more efficient and compact and can therefore be directed to specific areas, producing a bright, white light brighter than incandescent lamps of the same wattage.

They are dimmable with all forms of modern dimmer control.

Linear fluorescent

Up to 5 times more efficient and lasting up to 8 and even 15 times longer than incandescent. However, unlike halogen and tungsten these lamps require ballasts that control the current. Dimming can be achieved with many forms of electronic ballast. High output T5 diameter lamps are becoming the standard for commercial installations.

Compact fluorescent lamps

CFL's have the same characteristics and advantages of linear fluorescents, but are folded into compact shapes. Many wattages are available, from 5W to 80W. External Ballast high frequency (Non retrofit) – Compact in size the 2 pin and 4 pin CFL's require a separate ballast. Integral Ballast high frequency CFLi or low energy lamps – These lamps have internal electronic ballasts and can be used as direct replacements for GLS, candles and other lamps. They are central to achieving domestic lighting Carbon Emission Reduction Targets. The availability, types and styles of CFLi's and of dimmable versions will increase significantly with the progressive withdrawal of Incandescent lamps from the marketplace.

LED

Light Emitting Diode lamps can last for up to 50,000 hours. All LED light sources require some form of current control; either built into the lamp, such as in retrofit GU10's, or an external driver. For actual illumination the minimum wattage of retrofit lamps should be at least 3 Watts. LED lighting is currently in its infancy but is likely to eventually become a dominant light source. The availability of controllable LED's is currently poor but will become more prevalent.

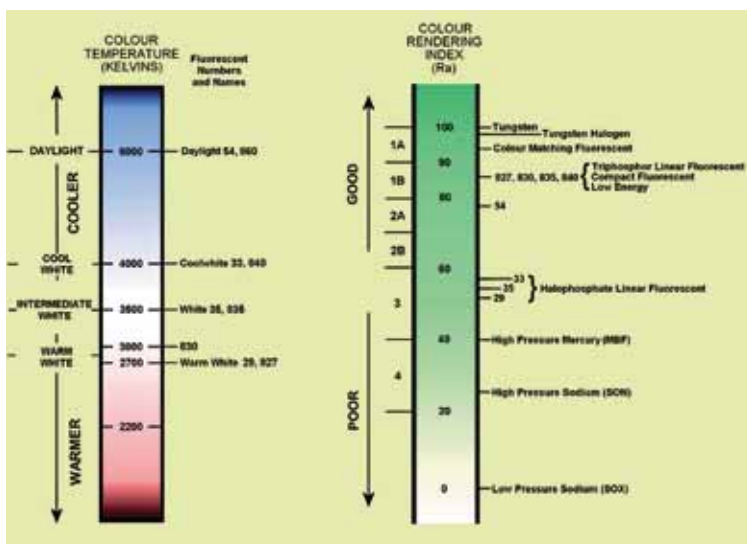

Luminaire classification

Quality

All fittings produced by GET are manufactured and tested under a quality assurance system in accordance with EN ISO 9002: 1994, and are designed to comply with EN 60598

Compliance

The European Norm Electromechanical Certification (ENEC) has been adopted as a common mark of conformity with European Standards. A mark issued by any single national approbation bodies implies compliance with all seventeen international bodies. The ENEC mark now replaces the national test house symbol, and is appended by a number indicating from which test house the approbation originated.

CE marking

- CE marking indicates compliance with the requirements of:
1. Low voltage directive for electrical safety (73/23/EEC as amended by 93/96/EEC)
 2. EMC directive for electro magnetic compatibility (89/336/EEC as amended by 92/31/EEC)

Radio supression

EN 55015, EN 61000 & EN 61547
Fittings comply with radio interference supression and electromagnetic compatibility (EMC) regulations.

Feature symbols



Voltage

Fittings and transformers are supplied primarily for operation on 230/240V 50Hz. For alternative electrical specifications contact our Technical Support Department.

Electrical protection

- Class 1 Fittings comply with class 1 (I) earthed electrical requirements i.e. functional insulation in all parts and earth termination.
- Class 2 Fittings comply with class 2 (II) double insulated electrical requirements i.e. complete insulation in all parts without earth termination. In the event of an electrical fault, no dangerous voltage can reach touchable metal parts.
- Class 3 Fittings comply with class 3 (III) triple insulated electrical requirements i.e. designed to connect to an external low voltage supply which is the same as the internal operating voltage requirement. In the event of an electrical fault, no dangerous voltage can develop.

Inflammability of surface protection

- EN 60598
-  Suitable for mounting in or on furniture made or semi-incombustible or normally combustible materials such as wood.
 -  Fittings made for mounting in or on furniture made of materials of unknown properties.

Equivalent wattages for energy saving lamps

■ Energy saving lamps last up to 8 times longer than standard lamps

Standard	Energy saving
15 Watts	4 Watts
30 Watts	7 Watts
40 Watts	9 Watts
60 Watts	11 Watts
70 Watts	13/15 Watts
100 Watts	20 Watts

GET lighting control products are compatible with many lamp types. Please check the table below for suitability.

Lamp type		Dimmer					Switch						
		Rotary	Electronic	1000W	Sphere	ULTI	Plate/ Toggle	Time delay	Key card	Card switches	PIR	Photocell	ULTI
Incandescent													
GLS, Candle, Decorative, Golfball, striplight etc	MV	●	●	●	●	●	●	●	●	●	●	●	●
Halogen - GU10, G9, R7s, Halogen replacements	MVH	●	●	●	●	●	●	●	●	●	●	●	●
Halogen - MR16, G4, MR11, GU4, GU5.3.	LVH	●	●	●	●	●	●	●	●	●	●	●	●
Fluorescent CFL													
Tubular, compact double D 2 pin/4 pin		-	-	-	-	-	●	●	●	●	●	●	●
CFLi													
Stick, Candle, Spiral,													
Golfball, GX53, GU10, Energy saving pendant	MV	-	-	-	-	-	●	●	●	●	●	●	●
Dimmable CFLi	MV	●	-*	-*	-*	●*	●	●	●	●	-	●	●
Linear													
Mini batten, T4, T5	MV	-	-	-	-	-	●	●	●	●	●	●	●
T8 magnetic ballast HPF, LPF	MV	-	-	-	-	-	●	●	●	●	●	●	●
T8 / High output T5 HF	MV	-	-	-	-	-	●	●	●	●	●	●	●
HID													
Mercury Vapor	MV	-	-	-	-	-	●	●	●	●	●	●	●
Self-Ballasted Mercury Vapor	MV	-	-	-	-	-	●	●	●	●	●	●	●
Metal Halide	MV	-	-	-	-	-	●	●	●	●	●	●	●
High Pressure Sodium	MV	-	-	-	-	-	●	●	●	●	●	●	●
Low Pressure Sodium	MV	-	-	-	-	-	●	●	●	●	●	●	●
Light Emitting Diode													
LED with Driver	MV	-	-	-	-	-	●	●	●	●	●	●	●
LED Replacement													
GU10, MR16	MV	-*	-*	-*	-*	-*	●	●	●	●	●	●	●

Notes*

The availability, types and styles of dimmable CFLi's and LED's will increase significantly with the progressive withdrawal of Incandescent lamps from the marketplace. Check with the Technical Support helpline (Tel 0870 608 8 608) or website to determine if your lamp is compatible with GET controls.

N.B.

MV = Mains voltage

MVH = Mains voltage halogen

LVH = Low voltage halogen

● = compatible

-* = not compatible

Recommended minimum number of air changes in certain environments

Environment	Changes per hour	Environment	Changes per hour	Environment	Changes per hour
Bathrooms and shower rooms	3	Halls and landings	3	Shops	8
Bedrooms	2	Hospital rooms	4	Sports facilities	6
Cafés	10	Kitchens (domestic)	10	Store rooms	3
Canteens	8	Laundries and laundrettes	10	Toilets (domestic)	3
Cellars	3	Living and other domestic rooms	3	Toilets (public)	10
Changing rooms with showers	15	Meeting rooms	4	Utility rooms	15
Conference rooms	8	Offices	6	Workshops	6
Garages	6	Restaurants & bars	6		
Hairdressing salons	10	School rooms	2		

Example 1

Room	Bathroom
Volume	2.0 x 2.0 x 2.0 = 8m ³
Number of air changes required	3
Performance	8 x 3 = 24m ³ /h
Fan required	GFAN4 = 93m ³ /h

Example 2

Room	Kitchen
Volume	2.8 x 2.8 x 2.8 = 22m ³
Number of air changes required	10
Performance	22 x 10 = 220m ³ /h
Fan required	GFAN6 = 250m ³ /h

Stale air is also removed by installing the appropriate GET fan. In certain circumstances, such as in toilets, a timer is incorporated to provide an automatic turn-on period of up to 25 minutes as stipulated in The Building Regulations.

	Standard 4" 100mm	Standard 4" 100mm slimline	Premium 4" 100mm slimline	4" 100mm panel	Premium 6" 150mm
Voltage Supply	220 - 240V 50Hz	230V - 50Hz	220 - 240V 50Hz	220 - 240V 50Hz	220 - 240V 50Hz
Power	20W Max	26W Max	16W	16W	26W
Timer Control (where applicable)	3 - 25 mins	3 - 25 mins	1 - 25 mins	1 - 25 mins	1 - 25 mins
Humidistat Timer Control (where applicable)	3 - 50 mins	1 - 50 mins	1 - 25 mins	1 - 25 mins	1 - 25 mins
Extract Capacity	93 ³ /hr max	250 ³ /hr max	129 ³ /hr	115 ³ /hr	295 ³ /hr
Humidity Adjustment	50 - 60%	50 - 90%	60 - 90%	60 - 90%	60 - 90%
Noise Level	45dB	35dB	37dB	36dB	39dB
IP Rating	IPX4	IPX4	IP24	IP24	IP24
Max. Room Temperature	40°C	40°C	45°C	45°C	45°C
Double Insulated	yes	yes	yes	yes	yes
Fitted with Fused Thermal Protection	yes	yes	yes	yes	yes

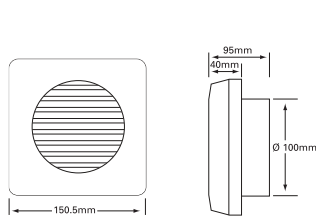

Standard 4" (100mm)

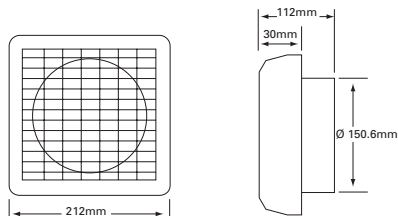

Standard 6" (150mm)

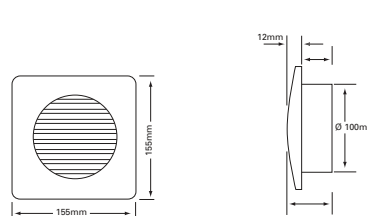

Standard 4" (100mm) slimline

Dimensions

Part number		A	B	C	D
GPGPTFAN4TB	Designer Range	126	32	100	170
GSPTFAN4T	Premium Range	126	30	100	150
GSPTFAN4LT	Aluminium Panel	126	30	100	150

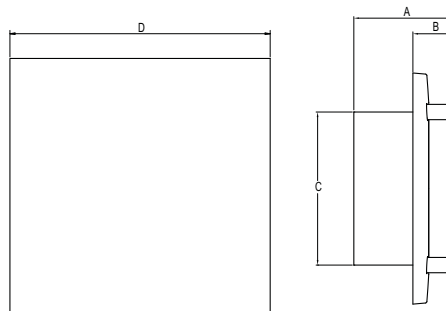

Specifications for 12V SELV unit

Controller	
Voltage Supply	230V 50Hz
Voltage Output	12V 50Hz 20VA
Timer Control (where applicable)	3 – 25 minutes

Fan	
Extract Capacity	93m ³ /hr max
Noise Level	45dB (A)
IP Rating	IPX4
Max Room Temperature	40°C
Double Insulated	Class III SELV
Fitted with Fused Thermal Protection	Yes

Specifications for 150mm/6" fans

150mm/6" wall fans	
Voltage Supply	230V 50Hz
Power	28W Max
Timer Control (where applicable)	3 – 25 minutes
Humidistat Timer Control (where applicable)	3 – 50 minutes
Extract Capacity	250m ³ /hr max
Noise Level	35dB
IP Rating	IPX4
Max Room Temperature	40°C
Double Insulated	<input type="checkbox"/>
Fitted with Fused Thermal Protection	Yes
Humidity Adjustment	50% – 90%

Humidistat variants

Humidity override is primary to any other means of control, i.e. timer or pull cord. This ensures optimum operation at all time.

Installation methods

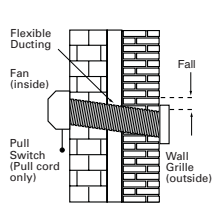

Diagram 1a

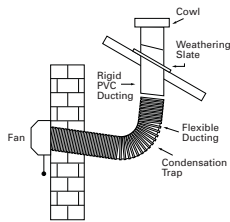

Diagram 1b

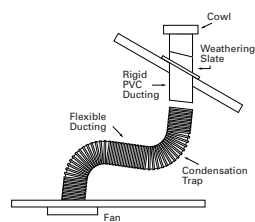

Diagram 1c

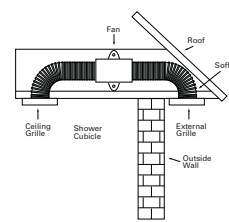

Diagram 1d

4" Fans are not designed for installation in showers. For this specification inline fan should be used. See diagram 1d

Wiring diagrams

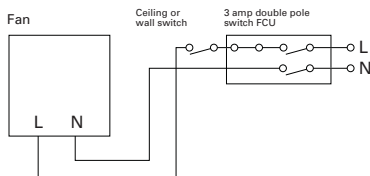

Diagram 2a Fan without Timer and Fan with humidistat/pull cord override

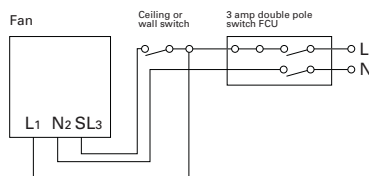

Diagram 2b Fan with Timer

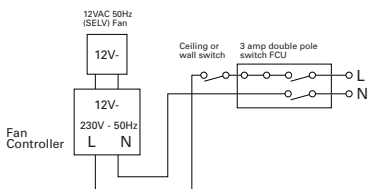

Diagram 2c 12V Fan without Timer

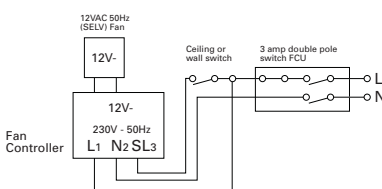

Diagram 2d 12V Fan with Timer

Alpha numerical index

Item	Page No.	Item	Page No.	Item	Page No.
400112	115	56SO313LEGY	130	E238WE	107
400113	115	56SO313LERO	130	E251BP	108
400114	115	56SO3164LEGY	131	E251WE	108
301SMWE	110	56SO3166LEGY	131	E25CESFNWE	104
302SMWE	110	56SO3326LEGY	131	E25CESFWE	104
30FLM15WE	110	56SO332GY	133	E25DF32BP	108
30M20WE	110	56SO4166LEGY	131	E25DF32WE	108
30M35WE	110	56SO4326LEGY	131	E25DWE	104
30MBPNWE	110	56SO5166LEGY	131	E25NWE	104
30MBPRWE	110	56SO5326LEGY	131	E25SFWE	104
30MBPWWE	110	56SSW10LEGY	131	E25WE	104
30MD20WE	110	56SSW15LEGY	131	E30FSGNWE	106
30MIWE	110	56SSW15LERO	131	E30FSGWE	106
30NGR	110	56SSW210LEGY	131	E30T6A	105
30NRD	110	56SSW215LEGY	131	E311SAWE	105
30PFMWE	110	56SW110LEGY	130	E312SAWE	105
30PWE	110	56SW110LERO	130	E312XWE	107
30RJ88SMA5SHWE	110	56SW120LEGY	130	E319WE	105
30TKMWE	110	56SW120LERO	130	E31D20GEWE	106
30TV75MSWE	110	56SW132LEGY	130	E31DFSGNWE	106
30WE	105	56SW220COLEGY	131	E31DFSGWE	106
31J	110	56SW220LEGY	130	E31IAWE	105
32E450LMWE	110	56SW220LERO	130	E31RD400WE	105
32E450TMWE	110	56SW232LEGY	130	E31TBWE	106
32WE	110	56SW232LERO	130	E31TV75WE	107
360BK	98	56SW310LEGY	131	E31TVFWE	107
360WE	98	56SW320LEGY	131	E31WE	110
363BR	98	56SW320LERO	131	E31WP23SAWE	105
363WE	98	56SW332LEGY	131	E31WPWE	105
39MWE	110	56SW332LERO	131	E31XWE	107
5632LEGY	132	56SW363LEGY	131	E322SAWE	105
5632LERO	132	56SW363LERO	131	E32D20NGEWE	106
56C31324ELGY	130	56SW420LEGY	131	E32TV75WE	107
56C3134ELGY	130	56SW420LERO	131	E32WE	110
56C313GY	133	701WE	107	E332SAWE	105
56CB4NGY	132	9WE	110	E33WE	110
56CV313LEGY	130	ADAPT2W	115	E34061MWE	107
56E1GY	132	ADAPT3WF	115	E34061SWE	107
56E1RO	132	CCTR1P004	119	E342SAWE	105
56E24ELGY	132	CCTR1P008	119	E34WE	110
56E2GY	132	CFLDD16W8352P	156	E35WE	110
56E2RO	132	CFLDD16W8354P	156	E4265WE	104
56E3GY	132	CFLDD28W8352P	156	E426WE	104
56E3RO	132	CFLDD28W8354P	156	E501SSWE	112
56E4GY	132	CFLDD38W8354P	156	E5512S	124
56E4RO	132	CFLR507W827GU	144	E551SS	124
56E4VHGY	132	CRA12W	114	E551US	124
56E6GY	132	CRB2W	115	E5522S	124
56E6RO	132	CSC313	126	E552US	124
56E8GY	132	CSO313	126	E55CB	124
56E8RO	132	CSO3132	126	E55GP	124
56E9GY	132	CSW120	126	E55PB	124
56ED2GY	132	CSW1202	126	E727WE	107
56ES1GY	132	CSW220	126	E750WPRGY	119
56ES2GY	132	DDA1BL	31	E751	118
56ES2RO	132	DDA1CH	31	E751R	118
56FA1GY	133	DDA2BL	31	E93PS6WE	112
56FA2GY	133	DDA2CH	31	E93PS9WE	112
56FA3GY	133	E1515WE	104	E93WE	112
56FA4GY	133	E15DWE	104	E94WE	112
56FCUGY	133	E15NWE	104	ED4513NWE	106
56FCULEGY	130	E15WE	104	ED4513WE	106
56JB1GY	133	E192030BK	98	ED45NWE	106
56L1GY	132	E192030MIBK	98	ED45WE	106
56L2GY	132	E192030WE	98	ET01E	107
56P310GY	131	E1920MB1PN	98	ET238WE	107
56P313GY	131	E1920MB2PN	98	ET36WE	110
56P313RO	131	E1920MBR1PN	98	G20FH11	167
56P315GY	131	E1920R30MIWE	98	G20FH5	167
56SO313GY	133	E1920R30WE	98	G20FH5W	167

Alpha numerical index

Item	Page No.	Item	Page No.	Item	Page No.
G20FH7	167	GDFLGEDW	140	GDLGS50BN	143
G20FH9	167	GDFLGS50CL	141	GDLGS50C	143
G20FH9T	167	GDFLGS50SSL	141	GDLGS50SS	143
G2BFHP	166	GDFLGS50WL	141	GDLGS50W	143
G2CH	167	GDFLGT50CL	141	GDLGT50BN	143
G2CHT	167	GDFLGT50SSL	141	GDLGT50C	143
G2FHT2	167	GDFLGT50WL	141	GDLGT50SS	143
G2HAL	167	GDFLLD50CL	140	GDLGT50W	143
G2TCH	167	GDFLLD50SSL	140	GDLGTD50BN	142
G2TCHT	167	GDFLLD50WL	140	GDLGTD50C	142
G3HAL2	167	GDFLLED16WCO	154	GDLGTD50SS	142
G45ACCU	93	GDFLLED16WCOE	154	GDLGTD50W	142
G45ACCUN	93	GDFLLED16WSO	154	GDLGX53C	147
G45CX	93	GDFLLED16WSOE	154	GDLGX53SS	147
GABAT	112	GDFLLED16WWO	154	GDLGX53W	147
GABATC	112	GDFLLED16WWOE	154	GDLL50BN	142
GADAPTSVR	93	GDFLLS50CL	140	GDLL50C	142
GBAT	112	GDFLLS50SSL	140	GDLL50SS	142
GBATC	112	GDFLLS50WL	140	GDLL50W	142
GBATS	113	GDFLLTD50CL	140	GDLLC20C	147
GBG01	80/87/102	GDFLLTD50SSL	140	GDLLC20W	147
GBG02	80/87/102	GDFLLTD50WL	140	GDLLD50BN	141
GBG03	80/87/102	GDFR16WBO	155	GDLLD50C	141
GBG04F	80/87	GDFR16WBOE	155	GDLLD50SS	141
GBG04S	80/102	GDFR16WBP	155	GDLLD50W	141
GBG06F	80	GDFR16WWO	155	GDLLS50BN	142
GBG06S	80/102	GDFR16WWP	155	GDLLS50C	142
GBGS01	102	GDFR28WBO	155	GDLLS50SS	142
GBGS02	102	GDFR28WBOE	155	GDLLS50W	142
GBGS03	102	GDFR28WBP	155	GDLLT50BN	142
GBGS04S	102	GDFR28WBPE	155	GDLLT50C	142
GBGS06S	102	GDFR28WWO	155	GDLLT50SS	142
GBH100BC	157	GDFR28WWOE	155	GDLLT50W	142
GBH100BR	157	GDFR28WWP	155	GDLLTD50BN	141
GBLANK1G	93	GDFR28WWPE	155	GDLLTD50C	141
GBLANK2G	93	GDFRS16WBO	155	GDLLTD50SS	141
GCKR45A	93	GDFRS16WBP	155	GDLLTD50W	141
GCKR45A2G	93	GDFRS16WWO	155	GDRSLED12BC	138
GCKRN45A	93	GDFRS16WWP	155	GDRSLED12C	138
GCKRN45A2G	93	GDFS16WBO	155	GDRSLED12W	138
GD1G1W	91	GDFS16WBP	155	GDUCT410M	163
GD1G1W4	91	GDFS16WWO	155	GDUCT415M	163
GD1G2W	91	GDFS16WWP	155	GDUCT43M	163
GD1G2W4	91	GDFS28WBO	155	GDUCT46M	163
GD2G1W	91	GDFS28WBOE	155	GDUCT63M	163
GD2G2W	91	GDFS28WBP	155	GE115P	116
GD3G2W	91	GDFS28WBPE	155	GE115S	116
GD4G2W	91	GDFS28WWO	155	GE125P	116
GDFCLED12BC	138	GDFS28WWOE	155	GE157P	116
GDFCLED12C	138	GDFS28WWP	155	GE197P	116
GDFCLED12W	138	GDFS28WWPE	155	GE249P	116
GDFCSLED12BC	138	GDFSLED07C	139	GE321P	116
GDFCSLED12C	138	GDFSLED07SS	139	GE381P	116
GDFCSLED12W	138	GDFSLED07W	139	GE84S	116
GDFFLED07C	139	GDFTLEDO7C	139	GE884S	116
GDFFLED07SS	139	GDFTLEDO7SS	139	GEBAT	112
GDFFLED07W	139	GDFTLEDO7W	139	GEBP6	116
GDFLED16WBO	154	GDL1	115	GEBP7	116
GDFLED16WBOE	154	GDL2	115	GEBP8	116
GDFLED16WBP	154	GD LCS126G	147	GEBP9	116
GDFLED16WBPE	154	GD LCS226FG	147	GEP1512***	96
GDFLED16WWO	154	GD LCS226G	147	GEP1512T**	96
GDFLED16WWOE	154	GDLG50BN	143	GEP1513***	96
GDFLED16WWP	154	GDLG50C	143	GEP1514***	96
GDFLED16WWPE	154	GDLG50SS	143	GEP1522***	96
GDFLGD50CL	141	GDLG50W	143	GEP1522T**	96
GDFLGD50SSL	141	GDLGD50BN	142	GEP1532***	96
GDFLGD50WL	141	GDLGD50C	142	GEP1542***	96
GDFLGEDC	140	GDLGD50SS	142	GEP2510***	97
GDFLGEDSS	140	GDLGD50W	142	GEP2511***	97

Alpha numerical index

Item	Page No.	Item	Page No.	Item	Page No.
GEP3510***	96	GJB20ABR	113	GPAT2GC25	94
GEP3520***	96	GJB30ABR	113	GPAT3G25	94
GEP3550***	96	GJB5ABR	113	GPATDG25	94
GEP3560***	96	GJB620ABR	113	GPC500CK	157
GEP3580***	96	GJBN20ABR	113	GPEND6	112
GEP4501***	97	GJBN20ASBR	113	GPEND6C	112
GEP4520***	97	GLHC	112	GPEND6S	113
GEP4521***	97	GLHCS	113	GPEND9	112
GEP5500***	97	GLVD1G1W	92	GPEND9C	112
GEP5501***	97	GLVD1G1W4	92	GPGPTFAN4TB	162
GEP5510***	97	GLVD1G2W	92	GPGPTFAN4TW	162
GEP5511***	97	GLVD1G2W4	92	GPULLGY	31
GEP6512**	96	GLVD2G1W	92	GPULLRD	31
GEP6512LV**	96	GLVD2G2W	92	GR**1012	84
GEP6522**	96	GMC131S	100	GR**1022	84
GEP6522LV**	96	GMC131SS	100	GR**1032	84
GEP6532LV**	96	GMC132S	100	GR**2010	84
GEP6542LV**	96	GMC132SS	100	GR**3010	84
GEP7510***	98	GMC13SP	101	GR**3020	84
GEP7521**	98	GMC13SPF	101	GR**4011	84
GEP7561***	97	GMC13SPN	101	GR**5010	85
GEP7562***	97	GMC13SPNF	101	GR**6012	84
GEP7581**	98	GMC13SSP	101	GR**6022	84
GEP7590***	97	GMC13SSPF	101	GR**7010	85
GEP8510**	98	GMC13SSPN	101	GR**7016	85
GEP8520**	98	GMC13SSPNF	101	GR**7051	85
GESPENDE613	112	GMC20S	101	GR**7061	85
GESPENDE618	112	GMC20SN	101	GR**7062	85
GEURO1	70/93	GMC45S	101	GRGYWF01	30
GEURO2	70/93	GMC45S2N	101	GRL101**	86
GEURO4	70/93	GMC45SN	101	GRL102**	86
GFAN4	162	GMCS1S	100	GRL102R**	86
GFAN412	162	GMC612	100	GRL101**	86
GFAN412T	162	GMCS622	100	GRL13FCU**	86
GFAN4H	162	GMC632	100	GRL13FCUPW	122
GFAN4P	162	GMCB1	101	GRL13US**	86
GFAN4SWRT	163	GMCB2	101	GRL201**	86
GFAN4T	162	GMCINT	100	GRL202**	86
GFAN6	163	GMCS131S	100	GRL2020**	86
GFAN6P	163	GMCS131SS	100	GRL2020PW	122
GFAN6T	163	GMCS132S	100	GRL202KPW	122
GFANC4SL	162	GMCS132SS	100	GRL20DP**	86
GFANC4SLC	162	GMCS13SP	101	GRL20DPK**	86
GFANC4SLT	162	GMCS13SPF	101	GRL20DPKPW	122
GFANC4SLTC	162	GMCS13SPN	101	GRL20DPN**	86
GFANIL	163	GMCS13SPNF	101	GRL20DFNPW	122
GFANILT	163	GMCS13SSP	101	GRLCO**	86
GFFGRIL4B	163	GMCS13SSPF	101	GRLCOAX**	86
GFFGRIL4W	163	GMCS13SSPN	101	GRLCOPW	122
GFRIL4B	163	GMCS13SSPNF	101	GRLINRPW	122
GFRIL4W	163	GMCS20S	101	GRLS01G**	87
GFRIL6B	163	GMCS20SN	101	GRLS02G**	87
GFRIL6W	163	GMCS45S	101	GRLS03G**	87
GFHU2	167	GMCS45S2N	101	GRLS04G**	87
GFHUF2	167	GMCS45SN	101	GRLS06G**	87
GFOPLATE	92	GMCS51S	100	GRLS08G**	87
GGLLLED1A	157	GMCS612	100	GRLS09G**	87
GGLLLED1B	157	GMCS622	100	GRLS12G**	87
GGLLLED1G	157	GMCS632	100	GRO	112
GGLLLED1R	157	GMCSB1	101	GROC	112
GGLLLED1W	157	GMCSB2	101	GRWH1012	23
GGLLLEDK4W	157	GMCSINT	100	GRWH1012GY	30
GGLLTR105	157	GNSPUR	92	GRWH1014	23
GGLLTR60	157	GPAT1G16	94	GRWH1014GY	30
GGRIL4B	163	GPAT1G16A	28/94	GRWH1022	23
GGRIL4CH	163	GPAT1G25	94	GRWH1022GY	30
GGRIL4W	163	GPAT1G47	94	GRWH1032A	23
GGRIL6B	163	GPAT2G16A	28/94	GRWH1032GY	30
GGRIL6W	163	GPAT2G25	94	GSFAN6	163
GGTKIT	76/81	GPAT2G47	94	GSFAN6T	163

Alpha numerical index

Item	Page No.	Item	Page No.	Item	Page No.
GSFAN6TH	163	GSWDP20AFOTR	32/92	GTELSEC	93
GSFOPLATE	92	GSWDP20AHT	32/92	GTRE105	144
GSHVLIT2L	148	GSWDP20AOV	32/92	GTRE105P	144
GSHVLITFL2L	148	GSWDPN20A	92	GTRE150	144
GSHVLITL	148	GSWDPN20AFO	92	GTRE150P	144
GSHVSKT	93	GSWDPN20AFOAC	32/92	GTRE200	144
GSKT15A1G	90	GSWDPN20AFOHT	32/92	GTRE200P	144
GSKT1G	90	GSWDPN20AFOTR	32/92	GTRE65	144
GSKT2A1G	90	GSWDPN20AFOWH	92	GTRE65P	144
GSKT2G	90	GSWDPN20AHT	32/92	GU1011	23
GSKT5A1G	90	GSWDPN20AOV	32/92	GU1012	23
GSKTCOAX	93	GSWFDR35	9	GU1012A	23
GSKTCOAX2G	93	GSWHC5	8	GU1012GY	30
GSKTSW15A1G	90	GSWHC8	8	GU1012R	23
GSKTSW1G	90	GSWINT	91	GU1012RB	23
GSKTSW2G	90	GSWISO	91	GU1012RGY	30
GSKTSW2GEX	90	GSWNSPUR	92	GU1012RP	23
GSKTSW2GV	90	GSWNSPURBO	32/92	GU1013	23
GSKTSW3G	90	GSWNSPURCH	32/92	GU1014	23
GSKTSWDP2G	90	GSWNSPURDW	32/92	GU1014GY	30
GSLPH1000WB	166	GSWNSPUREF	32/92	GU1022	23
GSLPH1000WS	166	GSWNSPURFA	32/92	GU1022A	23
GSLPH1000WW	166	GSWNSPURFFZ	32/92	GU1022GY	30
GSLPH600WB	166	GSWNSPURFR	32/92	GU1032	23
GSLPH600WS	166	GSWNSPURFZ	32/92	GU1032GY	30
GSLPH600WW	166	GSWNSPURHO	32/92	GU1042	23
GSPH1000WB	166	GSWNSPURHT	32/92	GU1062	23
GSPH1000WS	166	GSWNSPURMW	32/92	GU1212***	55
GSPH1000WW	166	GSWNSPURP	92	GU1212R***	55
GSPH1400WB	166	GSWNSPURTD	32/92	GU1212T**	55
GSPH1400WS	166	GSWNSPURWD	32/92	GU1213***	55
GSPH1400WW	166	GSWNSPURWDY	32/92	GU1214***	55
GSPH600WB	166	GSWNSPURWM	32/92	GU1222***	55
GSPH600WS	166	GSWPULL45	113	GU1222T**	55
GSPH600WW	166	GSWPULL45N	113	GU1232***	55
GSPTFAN4T	162	GSWPULL6	113	GU1232T**	55
GSPTFAN4TA	162	GSWPULL62	113	GU1242***	55
GSPUR	92	GSWSPUR	92	GU1242T**	55
GSPUR3A	92	GSWSPURBO	32/92	GU1262***	55
GSPURHT	32/92	GSWSPURCH	32/92	GU1400F	37
GSPURP	92	GSWSPURDW	32/92	GU1412***	37
GSPURSS	32/92	GSWSPURDY	32/92	GU1412***	44/46
GSPURTD	32/92	GSWSPURF	32/92	GU1412K***	39
GSPURTR	32/92	GSWSPURFA	32/92	GU1412R***	37
GSPURWD	32/92	GSWSPURFFZ	32/92	GU1412T**	37
GSPURWDY	32/92	GSWSPURFR	32/92	GU1412TCLR	46
GSPURWM	32/92	GSWSPURFZ	32/92	GU1413***	37
GSSTFAN4T	162	GSWSPURHO	32/92	GU1413***	44
GSSTFAN4TH	162	GSWSPURHT	32/92	GU1414***	37
GSW10VFLDR	9	GSWSPURMW	32/92	GU1422***	37
GSW1G1W	91	GSWSPURP	92	GU1422***	44/46
GSW1G2W	91	GSWSPURTD	32/92	GU1422T**	37
GSW1G2WR	91	GSWSPURWD	32/92	GU1422TCLR	46
GSW1G2WRB	91	GSWSPURWDY	32/92	GU1432***	37
GSW1G2WRP	91	GSWSPURWM	32/92	GU1432***	46
GSW1GFP5**	8	GSWWC5	8	GU1432T**	37
GSW1GFP8**	8	GSWWC8	8	GU1442***	37
GSW2G2W	91	GSWWDR30	9	GU1442***	37
GSW2GFP5**	8	GSWWDRFP**	8	GU1442T**	37
GSW2GFP8**	8	GT4FL10W35	146	GU1462***	37
GSW3G2W	91	GT4FL16W35	146	GU1512***	66
GSW4G2W	91	GT4FL20W35	146	GU1513***	66
GSWA1G2W	91	GT4FL30W35	146	GU1514***	66
GSWA2G2W	91	GT4FL6W35	146	GU1522***	66
GSWCDR35	9	GT5FL13W35	146	GU1532***	66
GSWCRR5A	9	GT5FL21W35	146	GU1542***	66
GSWDP20A	92	GT5FL28W35	146	GU2003	24
GSWDP20AFO	92	GT5FL8W35	146	GU2010	24
GSWDP20AFOAC	32/92	GTELMAS	93	GU2010GY	30
GSWDP20AFOHT	32/92	GTELRJ11	93	GU2010HT	25/33
		GTELRJ45	93	GU2010OV	25/33

Alpha numerical index

Item	Page No.	Item	Page No.	Item	Page No.
GU2011	24	GU3420DWPCMP	37	GU5011FZ	25/33
GU2011HT	25/33	GU3420DWPWMP	37	GU5011GY	30
GU2011OV	25/33	GU3420DWSSMP	37	GU5011HO	25/33
GU2011TR	25/33	GU3421***	36	GU5011HT	25/33
GU2013	24	GU3431***	36	GU5011MW	25/33
GU2013AC	25/33	GU3434***	36	GU5011TD	25/33
GU2013HT	25/33	GU3450***	36	GU5011WD	25/33
GU2013TR	25/33	GU3460***	36	GU5011WM	25/33
GU2014	24	GU3470***	36	GU5013	25
GU2014AC	25/33	GU3480***	36/44	GU5014	25
GU2014HT	25/33	GU3490***	36	GU5200***	57
GU2014WH	24	GU3510***	66	GU5203***	57
GU2033	24	GU3520***	66	GU5210***	57
GU2210***	56	GU3531***	66	GU5211***	57
GU2211***	56	GU3580***	66	GU5213***	57
GU2213***	56	GU4000	26	GU5214***	57
GU2214***	56	GU4001	26	GU5400***	39
GU2214WH***	56	GU4010	26	GU5403***	39
GU2410***	39	GU4011	26	GU5410***	39/47
GU2410***	47	GU4020	26	GU5411***	39/44
GU2411***	39	GU4021	26	GU5413***	39
GU2411***	44	GU4031	24	GU5414***	39
GU2413***	39	GU4050	26	GU5500***	67
GU2414***	39	GU4201***	57	GU5510***	67
GU2414WH***	39	GU4221***	57	GU5511***	67
GU2511***	67	GU4231***	56	GU5514***	67
GU2513***	67	GU4401***	39/45	GU6000RC1	38/55/79
GU3010	22	GU4421***	39	GU6011	24
GU3010D	22	GU4431***	39	GU6011LV	24
GU3010DGY	30	GU4501***	67	GU6012	24
GU3010DRD	31	GU4521***	67	GU6012LV	24
GU3011	22	GU5000	25	GU6022	24
GU3020	22	GU50003	25	GU6022LV	24
GU3020D	22	GU5000HT	25/33	GU6032	24
GU3021	22	GU5000MW	25/33	GU6032LV	24
GU3030	22	GU5000RD	31	GU6042	24
GU3030GY	30	GU5000SS	25/33	GU6042LV	24
GU3030RD	31	GU5000TD	25/33	GU6211**	56
GU3031	22	GU5000TR	25/33	GU6211LV**	56
GU3032	22	GU5000WD	25/33	GU6212**	56
GU3033	22	GU5001	25	GU6212E**	55
GU3034	22	GU5003	25	GU6212LV**	56
GU3050	22	GU50033	25	GU6212R**	55
GU3060	22	GU5003TR	25/33	GU6222**	56
GU3060RD	31	GU5004	25	GU6222E**	55
GU3070	23	GU5010	25	GU6222LV**	56
GU3080	23	GU5010BO	25/33	GU6232**	56
GU3090	23	GU5010CH	25/33	GU6232LV**	56
GU3091	23	GU5010DW	25/33	GU6242**	56
GU3210***	54	GU5010EF	25/33	GU6242LV**	56
GU3210D***	54	GU5010FA	25/33	GU6411**	38
GU3211***	54	GU5010FFZ	25/33	GU6411LV**	38
GU3220***	54	GU5010FR	25/33	GU6412**	38/44
GU3220D***	54	GU5010FZ	25/33	GU64121***	38
GU3221***	54	GU5010GY	30	GU6412CLR	47
GU3250***	54	GU5010HO	25/33	GU6412E***	38
GU3251W**	55	GU5010HT	25/33	GU6412LV**	38
GU3252W**	55	GU5010MW	25/33	GU6412R***	38
GU3260***	54	GU5010RDW	31	GU6412RB	47
GU3270***	54	GU5010TD	25/33	GU6422**	38/44
GU3280***	54	GU5010WD	25/33	GU6422CLR	47
GU3290***	54	GU5010WM	25/33	GU6422E***	38
GU3410***	36	GU5011	25	GU6422LV**	38
GU3410D***	36	GU5011BO	25/33	GU6422RB	47
GU3410D***	44/46	GU5011CH	25/33	GU6432**	38
GU3411***	36	GU5011DW	25/33	GU6432LV**	38
GU3420***	36	GU5011EF	25/33	GU6442**	38
GU3420D***	36	GU5011FA	25/33	GU6442LV**	38
GU3420D***	44/46	GU5011FFZ	25/33	GU6512**	66
GU3420DMP	37	GU5011FR	25/33	GU6522**	66

Alpha numerical index

Item	Page No.	Item	Page No.	Item	Page No.
GU6532**	66	GUE7071*	28/41/59/71/94	GUG202KEL***	78
GU7010	27	GUE7072*	28/41/59/71/94	GUG202KELWPW	74/77
GU7020	27	GUE7075*	28/41/59/71/94	GUG202KWPW	74/77
GU7021	27	GUE7081*	28/41/59/71/94	GUG202MB	78
GU7030	27	GUE7082*	28/41/59/71/94	GUG202MW	78
GU7040	27	GUE7091*	28/41/59/71/94	GUG202O***	78
GU7051	26	GUE8010*	28/41/59/71/94	GUG202OCW	74/77
GU7061	26	GUG01G	76/79/80	GUG202W	74/77
GU7062	26	GUG01GGY	76/31	GUG20DP**W	75/77
GU7071	27	GUG01GMC	76/80/102	GUG20DPK***	78
GU7072	27	GUG01GSMC	76/80/102	GUG20DPKELWPW	74/77
GU7074	27	GUG02G	76/80	GUG20DPKWPW	74/77
GU7081	27	GUG02G**	79/80	GUG20DPMB	78
GU7090	26	GUG02GGY	76/31	GUG20DPMW	78
GU7210***	58	GUG02GMC	76/80/102	GUG20DPW	74/77
GU7220***	58	GUG02GSMC	76/80/102	GUG24G	76/80
GU7230***	58	GUG03G	76/80	GUG24G**	79/80
GU7251***	58	GUG03G**	79/80	GUG24GMC	76/80/102
GU7261***	58	GUG03GGY	76/31	GUG24GSMC	76/80/102
GU7262***	58	GUG03GMC	76/80/102	GUGB***	79
GU7271***	58	GUG03GSMC	76/80/102	GUGBB	79
GU7290***	57	GUG04G	76/80	GUGBW	75/77/79
GU7410***	40/45/47	GUG04G**	79/80	GUGCO***	78
GU7420***	40	GUG04GGY	76/31	GUGCOWPW	74/77
GU7430***	40	GUG04GMC	76/80/102	GUGEMDIM***16	79
GU7451***	40	GUG04GSMC	76/80/102	GUGEMRDIMB16	79
GU7461***	40/45	GUG06G	76/80	GUGEMRDIMW16	79
GU7462***	40/45/47	GUG06G**	79/80	GUGEMW***	79
GU7471***	40	GUG06GMC	76/80/102	GUGINDBG	79
GU7490***	40/45	GUG06GSMC	76/80/102	GUGINDBO	79
GU7510***	68	GUG08G	76/80	GUGINDBR	79
GU7561***	68	GUG08G**	79/80	GUGINDWG	75/77/79
GU7562***	68	GUG08GMC	76/80/102	GUGINDWO	75/77/79
GU7590***	67	GUG08GSMC	76/80/102	GUGINDWR	75/77/79
GU8010	27	GUG09G	76/80	GUGKSK	76/81
GU8020	27	GUG09G**	79/80	GUGL01**	79/80
GU8050	28/70	GUG09GMC	76/80/102	GUGL02**	79/80
GU8060	28/70	GUG09GSMC	76/80/102	GUGL03**	79/80
GU8080	28/70	GUG101MB	78	GUGL04**	79/80
GU8210**	58	GUG101MW	78	GUGL06**	79/80
GU8220**	58	GUG101W	74/77	GUGL08**	79/80
GU8410**	40	GUG102MB	78	GUGR**	78
GU8420**	40	GUG102MW	78	GUGRBO**	78
GU8450**	41/59/70	GUG102R***	78	GUGRCH**	78
GU8460**	41/59/70	GUG102RW	74/77	GUGRDW**	78
GU8480**	41/59/70	GUG102T***	78	GUGREF**	78
GU8510**	68	GUG102W	74/77	GUGRFA**	78
GU8520**	68	GUG101MB	78	GUGRFR**	78
GU8550**	68/70	GUG101MW	78	GUGRFRFZ**	78
GU8560**	68/70	GUG101T***	78	GUGRFZ**	78
GU8580**	68/70	GUG101W	74/77	GUGRHE**	78
GU9116	28	GUG12G	76/80	GUGRHO**	78
GU9125	28	GUG12G**	79/80	GUGRJ11***	78
GU9135	28	GUG12GMC	76/80/102	GUGRJ11WPW	74/77
GU9147	28	GUG12GSMC	76/80/102	GUGRJ45***	78
GU9225	28	GUG13FCU***	79	GUGRJ45WPW	74/77
GU9235	28	GUG13FCUWPW	74/77	GUGRMW**	78
GU9247	28	GUG16CO***	79	GUGROV**	78
GU9D25	28	GUG16COWPW	74/77	GUGRTD**	78
GUE7000*	28/41/59/71/94	GUG18G	76/80	GUGRWD**	78
GUE7001*	28/41/59/71/94	GUG18G**	79/80	GUGRWDY**	78
GUE7010*	28/41/59/71/94	GUG18GMC	76/80/102	GUGRWH**	78
GUE7011*	28/41/59/71/94	GUG18GSMC	76/80/102	GUGRWM**	78
GUE7012*	28/41/59/71/94	GUG201MB	78	GUGS01G**	79/80
GUE7020*	28/41/59/71/94	GUG201MW	78	GUGS02G**	79/80
GUE7030*	28/41/59/71/94	GUG201W	74/77	GUGS03G**	79/80
GUE7040*	28/41/59/71/94	GUG2020MB	78	GUGS04G**	79/80
GUE7051*	28/41/59/71/94	GUG2020MW	78	GUGS06G**	79/80
GUE7061*	28/41/59/71/94	GUG2020W	74/77	GUGS08G**	79/80
GUE7062*	28/41/59/71/94	GUG202K***	78	GUGS09G**	79/80

Alpha numerical index

Item	Page No.	Item	Page No.	Item	Page No.
GUGS12G**	79/80	LP236HFE	150	U102RWM001****	13
GUGS18G**	79/80	LP236HPF	150	U105RHH001BPW1	13
GUGS24G**	79/80	LP236LPF	150	U106RWM001****	13
GUGSAT***	78	LP258HF	150	U10XARR001210	13
GUGSATWPW	74/77	LP258HFE	150	U201DST600001	12
GUGSHK	76/81	LP258HPF	150	U201SPMDPB00	13
GUGTELM***	78	LP258LPF	150	U201SRY2KW001	12
GUGTELMWPW	74/77	LP270HF	150	U202DST600001	12
GUGTELS***	78	LP270HFE	150	U202SRY2KW001	12
GUGTELSWPW	74/77	LP270HPF	150	UAX001	12
GUMSCO	27	LP270LPF	150	UAX003	13
GUP1411BSS	37/118	LPDK118	151	UAX004	12
GUPA1411BSS	37/118	LPDK136	151	UC15***	13
GWP1612	123	LPDK158	151	UC21DM***	12
GWP1614	123	LPDK218	151	UC21SW***	12
GWP1622	123	LPDK236	151	UC22DM***	12
GWP1632	123	LPDK258	151	UC22SW***	12
GWP2010	123	LPRK36W	151	UC31RJ***	13
GWP2011	123	LPRK58W	151	UC31TV***	13
GWP3010	123	LPRK70W	151	UC32TD***	13
GWP3020	123	LPSK118	151	UCT25***	13
GWP3050	123	LPSK136	151	UHEXSBN	76/81
GWP3060	123	LPSK158	151	UHEXSMS	76/81
GWP9000	122	LPSK170	151	UHEXSPB	76/81
GWPIU3020	122	LPSK218	151	UHEXSPN	76/81
GWPIU3020R	122	LPSK236	151	UHEXSPW	76/81
GWPIU3020RP	122	LPSK258	151	UHEXSSS	76/81
GWPIU3050	122	LPSK270	151	US155A00	13
GWPIU3060	122	LSKT1GR	90	US155XGL	13
GWPIUKIT	122	LSKT2GR	90	US15A00	13
GX53FL7W	156	LSKT2GRP	90	US15B00	13
HD35WGU10	144	MMB251W	113	US21DPPXGL	13
HD35WM281	144	MMB252W	113	US31RJ000	13
HD50WGU10	144	MMD252SW	113	US31TV000	13
HD50WM258	144	MTAU1W	114	US32TD000	13
HD50WM2582A	144	MTAU2W	114	USCREW50**	58
HDA	166	MTAU3W	114	UST25A00	13
HDAC	166	PBR332W	114	UST25B00	13
HDM	166	PBU441W	114	UST55B00	13
KBR251W	114	SAEUEMSCDBWE	118	VDI552012	16
KBR321W	114	SAEUEMSCSAWE	118	VDIR528010	16
KBR322W	114	SAEUEMSCUWE	118	VDIR534810	16
KBS252W	114	SAEUEMSIR10T	118	VDIR534830	16
KBU321W	114	SB161	115	VDIR542111	17
KBU322W	114	SB251	115	VDIR547402	17
KBU441W	114	SB252	115	VDIR547403	17
LINK1M	146	SB351	115	VDIR547404	17
LINK1M5	146	SB352	115	VDIR547405	17
LINK500	146	SB471	115	VDIR547406	17
LINK5005	146	SB472	115	VDIR580010	17
LMCSKT1GR	100	T4FL10W35	146	VDIR580020	17
LMCSKT2GR	100	T4FL16W35	146	VDIR580021	17
LMCSKT2GRP	100	T4FL20W35	146	VDIR593001	16
LP118HPF	150	T4FL30W35	146	VDIR643003	17
LP118LPF	150	T4FL6W35	146	VDIR647402	16
LP136HF	150	T5FL13W35	146	WHB320RG	126
LP136HFE	150	T5FL4W35	146	WHB340RG	126
LP136HPF	150	T5FL6W35	146	WHB355RG	126
LP136LPF	150	T5FL8W35	146	WHC363RG	126
LP158HF	150	TBR321W	113		
LP158HFE	150	TBR322W	113		
LP158HPF	150	TBU321W	113		
LP158LPF	150	TBU322W	113		
LP170HF	150	TBU441W	113		
LP170HFE	150	TOP13A	115		
LP170HPF	150	TOP15AR	115		
LP170LPF	150	TOP2AR	115		
LP218HPF	150	TOP3A	115		
LP218LPF	150	TOP5AR	115		
LP236HF	150	U101DFR400XBL1	12		

Notes



UK contact details -

0870 608 8 608

Fax 0870 608 8 606

Ireland contact details -

01 601 2200

Fax 01 601 2201

As a global specialist in energy management with operations in more than 100 countries, Schneider Electric offers integrated solutions across multiple market segments, including leadership positions in energy and infrastructure, industrial processes, building automation, and data centres/networks, as well as a broad presence in residential applications.

Focused on making energy safe, reliable, and efficient, the company's 110,000 plus employees achieved sales of 19.6 billion euros in 2010, through an active commitment to help individuals and organisations "Make the most of their energy."

We are changing our brand names and becoming one Schneider Electric. You'll get the same great quality products, but from one name you can remember and trust. This provides you and your customers with the reassurance associated with Schneider Electric.

Some of our market leading brands have already become Schneider Electric including **Merlin Gerin, Telemecanique, Square D, GET, Mita, Sarel, Himel, Thorsman, Tower** and **TAC**.

Working as one Schneider Electric makes it clearer that our ranges are highly compatible for integrated solutions.

Schneider Electric Ltd

United Kingdom
Stafford Park 5,
Telford
Shropshire
TF3 3BL
Tel: 0870 608 8 608
Fax: 0870 608 8 606
www.schneider-electric.co.uk

Ireland
Head office, Block a
Maynooth Business
Campus
Maynooth, Co. Kildare
Tel: (01) 601 2200
Fax: (01) 601 2201
www.schneider-electric.ie

Schneider Electric Limited is a company registered in England and Wales.
Registered number: 1407228. Registered office: Stafford Park 5, Telford, Shropshire TF3 3BL.

© 2011 Schneider Electric. All Rights Reserved. Schneider Electric, Active Energy Management, Compact, EcoStruxure, ION Enterprise, iRiO, Make the most of your energy, Masterpact, Micrologic, Power Plant To Plug, Modbus, and PowerLogic are owned by Schneider Electric Industries SAS, or its affiliated companies in the United States and other countries. 998-3432.

As standards, specifications and designs change from time to time, please ask for confirmation of the information given in this publication.

member of

