



CHAPMAN & HALL/CRC
Monographs and Surveys in
Pure and Applied Mathematics **141**

ASYMPTOTICS

AND BOREL

SUMMABILITY

Ovidiu Costin



CRC Press
Taylor & Francis Group

A CHAPMAN & HALL BOOK



CHAPMAN & HALL/CRC
Monographs and Surveys in
Pure and Applied Mathematics

141

ASYMPTOTICS

AND BOREL

SUMMABILITY

CHAPMAN & HALL/CRC

Monographs and Surveys in Pure and Applied Mathematics

Main Editors

H. Brezis, *Université de Paris*

R.G. Douglas, *Texas A&M University*

A. Jeffrey, *University of Newcastle upon Tyne (Founding Editor)*

Editorial Board

R. Aris, *University of Minnesota*

G.I. Barenblatt, *University of California at Berkeley*

H. Begehr, *Freie Universität Berlin*

P. Bullen, *University of British Columbia*

R.J. Elliott, *University of Alberta*

R.P. Gilbert, *University of Delaware*

R. Glowinski, *University of Houston*

D. Jerison, *Massachusetts Institute of Technology*

K. Kirchgässner, *Universität Stuttgart*

B. Lawson, *State University of New York*

B. Moodie, *University of Alberta*

L.E. Payne, *Cornell University*

D.B. Pearson, *University of Hull*

G.F. Roach, *University of Strathclyde*

I. Stakgold, *University of Delaware*

W.A. Strauss, *Brown University*

J. van der Hoek, *University of Adelaide*



CHAPMAN & HALL/CRC
Monographs and Surveys in
Pure and Applied Mathematics

141

ASYMPTOTICS

AND BOREL

SUMMABILITY

Ovidiu Costin



CRC Press

Taylor & Francis Group
Boca Raton London New York

CRC Press is an imprint of the
Taylor & Francis Group, an **informa** business
A CHAPMAN & HALL BOOK

Chapman & Hall/CRC
Taylor & Francis Group
6000 Broken Sound Parkway NW, Suite 300
Boca Raton, FL 33487-2742

© 2009 by Taylor & Francis Group, LLC
Chapman & Hall/CRC is an imprint of Taylor & Francis Group, an Informa business

No claim to original U.S. Government works
Printed in the United States of America on acid-free paper
10 9 8 7 6 5 4 3 2 1

International Standard Book Number-13: 978-1-4200-7031-6 (Hardcover)

This book contains information obtained from authentic and highly regarded sources. Reasonable efforts have been made to publish reliable data and information, but the author and publisher cannot assume responsibility for the validity of all materials or the consequences of their use. The authors and publishers have attempted to trace the copyright holders of all material reproduced in this publication and apologize to copyright holders if permission to publish in this form has not been obtained. If any copyright material has not been acknowledged please write and let us know so we may rectify in any future reprint.

Except as permitted under U.S. Copyright Law, no part of this book may be reprinted, reproduced, transmitted, or utilized in any form by any electronic, mechanical, or other means, now known or hereafter invented, including photocopying, microfilming, and recording, or in any information storage or retrieval system, without written permission from the publishers.

For permission to photocopy or use material electronically from this work, please access www.copyright.com (<http://www.copyright.com>) or contact the Copyright Clearance Center, Inc. (CCC), 222 Rosewood Drive, Danvers, MA 01923, 978-750-8400. CCC is a not-for-profit organization that provides licenses and registration for a variety of users. For organizations that have been granted a photocopy license by the CCC, a separate system of payment has been arranged.

Trademark Notice: Product or corporate names may be trademarks or registered trademarks, and are used only for identification and explanation without intent to infringe.

Library of Congress Cataloging-in-Publication Data

Costin, O. (Ovidiu), 1960-
Asymptotics and borel summability / Ovidiu Costin.
p. cm. -- (Monographs and surveys in pure and applied
mathematics ; 141)
Includes bibliographical references and index.
ISBN 978-1-4200-7031-6 (alk. paper)
1. Differential equations--Asymptotic theory. 2. Summability theory. I. Title.
II. Series.

QA372.C67 2008
515'.35--dc22

2008034107

Visit the Taylor & Francis Web site at
<http://www.taylorandfrancis.com>
and the CRC Press Web site at
<http://www.crcpress.com>

To my daughter, Denise Miriam

Some notations

\mathcal{L} —————	Laplace transform, §2.6		
\mathcal{L}^{-1} ———	inverse Laplace transform, §2.14		
\mathcal{B} —————	Borel transform, §4.4a		
\mathcal{LB} ———	Borel/BE summation operator, §4.4 and §4.4f		
p —————	usually, Borel plane variable	\mathbb{H} —————	open right half complex-plane.
\tilde{f} —————	formal expansion	\mathbb{H}_θ ———	half complex-plane centered on $e^{i\theta}$.
$H(p)$ ———	Borel transform of $h(x)$	\bar{S} —————	closure of the set S .
\sim —————	asymptotic to, §1.1a	C_a ———	absolutely continuous functions, [51]
$\mathbb{N}, \mathbb{Z}, \mathbb{Q}, \mathbb{R}, \mathbb{C}$		$f * g$ ———	convolution of f and g , §2.2a
$\mathbb{N}^+, \mathbb{R}^+$ ———	the nonnegative integers, integers, rationals, real numbers, complex numbers, positive integers, and positive real numbers, respectively	$L_\nu^1, \ \cdot\ _\nu,$	
		$\mathcal{A}_{K,\nu},$ etc. —	various spaces and norms defined in §5.1 and §5.2

Contents

1	Introduction	1
1.1	Expansions and approximations	1
1.1a	Asymptotic expansions	3
1.1b	Functions asymptotic to an expansion, in the sense of Poincaré	3
1.1c	Asymptotic power series	6
1.1d	Operations with asymptotic power series	6
1.2	Formal and actual solutions	9
1.2a	Limitations of representation of functions by expansions	10
1.2b	Summation of a divergent series	14
2	Review of some basic tools	19
2.1	The Phragmén-Lindelöf theorem	19
2.2	Laplace and inverse Laplace transforms	20
2.2a	Inverse Laplace space convolution	22
3	Classical asymptotics	25
3.1	Asymptotics of integrals: First results	25
3.1a	Discussion: Laplace's method for solving ODEs of the form $\sum_{k=0}^n (a_k x + b_k) y^{(k)} = 0$	26
3.2	Laplace, stationary phase, saddle point methods and Watson's lemma	27
3.3	The Laplace method	28
3.4	Watson's lemma	31
3.4a	The Borel-Ritt lemma	32
3.4b	Laplace's method revisited: Reduction to Watson's lemma	34
3.5	Oscillatory integrals and the stationary phase method	36
3.5a	Stationary phase method	39
3.5b	Analytic integrands	41
3.5c	Examples	42
3.6	Steepest descent method	44
3.6a	Further discussion of steepest descent lines	48
3.6b	Reduction to Watson's lemma	49
3.7	Application: Asymptotics of Taylor coefficients of analytic functions	52
3.8	Banach spaces and the contractive mapping principle	55

3.8a	Fixed points and vector valued analytic functions	57
3.8b	Choice of the contractive map	58
3.9	Examples	59
3.9a	Linear differential equations in Banach spaces	59
3.9b	A Puiseux series for the asymptotics of the Gamma function	59
3.9c	The Gamma function	61
3.9d	Linear meromorphic differential equations. Regular and irregular singularities	61
3.9e	Spontaneous singularities: The Painlevé's equation P_I	64
3.9f	Discussion: The Painlevé property	66
3.9g	Irregular singularity of a nonlinear differential equation	67
3.9h	Proving the asymptotic behavior of solutions of nonlinear ODEs: An example	68
3.9i	Appendix: Some computer algebra calculations	69
3.10	Singular perturbations	70
3.10a	Introduction to the WKB method	70
3.10b	Singularly perturbed Schrödinger equation: Setting and heuristics	71
3.10c	Formal reexpansion and matching	73
3.10d	The equation in the inner region; matching subregions	74
3.10e	Outer region: Rigorous analysis	74
3.10f	Inner region: Rigorous analysis	77
3.10g	Matching	79
3.11	WKB on a PDE	79
4	Analyzable functions and transseries	81
4.1	Analytic function theory as a toy model of the theory of analyzable functions	81
4.1a	Formal asymptotic power series	83
4.2	Transseries	92
4.2a	Remarks about the form of asymptotic expansions	92
4.2b	Construction of transseries: A first sketch	92
4.2c	Examples of transseries solution: A nonlinear ODE	96
4.3	Solving equations in terms of Laplace transforms	97
4.3a	A second order ODE: The Painlevé equation P_I	102
4.4	Borel transform, Borel summation	103
4.4a	The Borel transform \mathcal{B}	103
4.4b	Definition of Borel summation and basic properties	104
4.4c	Further properties of Borel summation	106
4.4d	Stokes phenomena and Laplace transforms: An example	109
4.4e	Nonlinear Stokes phenomena and formation of singularities	111
4.4f	Limitations of classical Borel summation	112

4.5	Gevrey classes, least term truncation and Borel summation	113
4.5a	Connection between Gevrey asymptotics and Borel summation	115
4.6	Borel summation as analytic continuation	118
4.7	Notes on Borel summation	119
4.7a	Choice of critical time	119
4.7b	Discussion: Borel summation and differential and difference systems	121
4.8	Borel transform of the solutions of an example ODE, (4.54) .	122
4.9	Appendix: Rigorous construction of transseries	122
4.9a	Abstracting from §4.2b	123
4.10	Logarithmic-free transseries	134
4.10a	Inductive assumptions	134
4.10b	Passing from step N to step $N + 1$	137
4.10c	General logarithmic-free transseries	140
4.10d	Écalle's notation	140
4.10e	The space \mathcal{T} of general transseries	142
5	Borel summability in differential equations	145
5.1	Convolutions revisited	145
5.1a	Spaces of sequences of functions	147
5.2	Focusing spaces and algebras	148
5.3	Example: Borel summation of the formal solutions to (4.54)	149
5.3a	Borel summability of the asymptotic series solution . .	149
5.3b	Borel summation of the transseries solution	150
5.3c	Analytic structure along \mathbb{R}^+	152
5.4	General setting	154
5.5	Normalization procedures: An example	154
5.6	Further assumptions and normalization	156
5.6a	Nonresonance	156
5.6b	The transseries solution of (5.51)	157
5.7	Overview of results	157
5.8	Further notation	158
5.8a	Regions in the p plane	158
5.8b	Ordering on \mathbb{N}^n	160
5.8c	Analytic continuations between singularities	160
5.9	Analytic properties of $\mathbf{Y}_{\mathbf{k}}$ and resurgence	160
5.9a	Summability of the transseries	162
5.10	Outline of the proofs	164
5.10a	Summability of the transseries in nonsingular directions: A sketch	164
5.10b	Higher terms of the transseries	166
5.10c	Detailed proofs, for $\operatorname{Re}(\alpha_1) < 0$ and a 1 parameter transseries	167

5.10d	Comments	171
5.10e	The convolution equation away from singular rays . .	172
5.10f	Behavior of $\mathbf{Y}_0(p)$ near $p = 1$	176
5.10g	General solution of (5.89) on $[0, 1 + \epsilon]$	181
5.10h	The solutions of (5.89) on $[0, \infty)$	185
5.10i	General L^1_{loc} solution of the convolution equation . . .	187
5.10j	Equations and properties of \mathbf{Y}_k and summation of the transseries	188
5.10k	Analytic structure, resurgence, averaging	193
5.11	Appendix	198
5.11a	$AC(f * g)$ versus $AC(f) * AC(g)$	198
5.11b	Derivation of the equations for the transseries for gen- eral ODEs	199
5.11c	Appendix: Formal diagonalization	201
5.12	Appendix: The C^* -algebra of staircase distributions, $\mathcal{D}'_{m,\nu}$.	202

6 Asymptotic and transasymptotic matching; formation of singularities **211**

6.0a	Transseries and singularities: Discussion	212
6.1	Transseries reexpansion and singularities. Abel's equation . .	213
6.2	Determining the ξ reexpansion in practice	215
6.3	Conditions for formation of singularities	216
6.4	Abel's equation, continued	218
6.4a	Singularities of F_0 and proof of Lemma 6.35	220
6.5	General case	222
6.5a	Notation and further assumptions	223
6.5b	The recursive system for the \mathbf{F}_m s	225
6.5c	General results and properties of the functions \mathbf{F}_m . .	226
6.6	Further examples	228
6.6a	The Painlevé equation P_I	228
6.6b	The Painlevé equation P_{II}	232

7 Other classes of problems **235**

7.1	Difference equations	235
7.1a	Setting	235
7.1b	Transseries for difference equations	236
7.1c	Application: Extension of solutions y_n of difference equa- tions to the complex n plane	236
7.1d	Extension of the Painlevé criterion to difference equa- tions	237
7.2	PDEs	237
7.2a	Example: Regularizing the heat equation	238
7.2b	Higher order nonlinear systems of evolution PDEs . .	239

8 Other important tools and developments	241
8.1 Resurgence, bridge equations, alien calculus, moulds	241
8.2 Multisummability	241
8.3 Hyperasymptotics	242
References	245

Preface

This book is intended to provide a self-contained introduction to asymptotic analysis, with special emphasis on topics not covered in classical asymptotics books, and to explain basic ideas, concepts and methods of generalized Borel summability, transseries and exponential asymptotics. The past thirty years have seen substantial developments in asymptotic analysis. On the analytic side, these developments followed the advent of Ecalle–Borel summability and transseries, a widely applicable technique to recover actual solutions from formal expansions. On the applied side, exponential asymptotics and hyperasymptotics vastly improved the accuracy of asymptotic approximations. These two advances enrich each other, are ultimately related in many ways, and they result in descriptions of singular behavior in vivid detail. Yet, too much of this material is still scattered in relatively specialized articles. Also, reportedly there still is a perception that asymptotics and rigor do not get along very well, and this in spite of some good mathematics books on asymptotics.

This text provides details and mathematical rigor while supplementing it with heuristic material, intuition and examples. Some proofs may be omitted by the applications-oriented reader.

Ordinary differential equations provide one of the main sources of examples. There is a wide array of articles on difference equations, partial differential equations and other types of problems only superficially touched upon in this book. While certainly providing a number of new challenges, the analysis of these problems is not radically different in spirit, and understanding key principles of the theory should ease the access to more advanced literature.

The level of difficulty is uneven; sections marked with * are more difficult and not crucial for following the rest of the material but perhaps important in accessing specialized articles. Similarly, starred exercises are more challenging.

The book assumes standard knowledge of real and complex analysis. [Chapters 1](#) through [4](#), and parts of [Chapters 5](#) and [6](#), are suitable for use in a graduate or advanced undergraduate course.

I would like to thank my colleagues R.D. Costin, S. Tanveer and G. Edgar, and my students G. Luo, L. Zhang and M. Huang for reading parts of the manuscript.

Since much of the material is new, some typos of the robust kind almost inevitably survived. I will maintain an erratum page, updated as typos are exposed, at www.math.ohio-state.edu/~costin/aberratum.

Chapter 1

Introduction

1.1 Expansions and approximations

Classical asymptotic analysis studies the limiting behavior of functions when singular points are approached. It shares with analytic function theory the goal of providing a detailed description of functions, and it is distinguished from it by the fact that the main focus is on singular behavior. Asymptotic expansions provide increasingly better approximations as the special points are approached, yet they rarely converge to a function.

The asymptotic expansion of an analytic function at a regular point is the same as its convergent Taylor series there. The local theory of analytic functions at regular points is largely a theory of convergent power series.

We have $-\ln(1-x) = \sum_{k=1}^{\infty} x^k/k$; the behavior of the log near one is transparent from the series, which also provides a practical way to calculate $\ln(1-x)$ for small x . Likewise, to calculate $z! := \Gamma(1+z) = \int_0^{\infty} e^{-t} t^z dt$ for small z we can use

$$\ln \Gamma(1+z) = -\gamma z + \sum_{k=2}^{\infty} \frac{(-1)^k \zeta(k) z^k}{k}, \quad (|z| < 1), \quad \text{where } \zeta(k) := \sum_{j=1}^{\infty} j^{-k} \quad (1.1)$$

and $\gamma = 0.5772..$ is the Euler constant (see [Exercise 4.62](#) on p. 99). Thus, for small z we have

$$\begin{aligned} \Gamma(1+z) &= \exp(-\gamma z + \pi^2 z^2/12 \dots) \\ &= \exp\left(-\gamma z + \sum_{k=2}^M (-1)^k \zeta(k) k^{-1} z^k\right) (1 + o(z^M)) \end{aligned} \quad (1.2)$$

where, as usual, $f(z) = o(z^j)$ means that $z^{-j} f(z) \rightarrow 0$ as $z \rightarrow 0$.

$\Gamma(z)$ has a pole at $z = 0$; $z\Gamma(z) = \Gamma(1+z)$ is described by the convergent

power series

$$z\Gamma(z) = \exp\left(-\gamma z + \sum_{k=2}^M k^{-1}(-1)^k \zeta(k) k^{-1} z^k\right) (1 + o(z^M)) \quad (1.3)$$

This is a perfectly useful way of calculating $\Gamma(z)$ for small z .

Now let us look at a function near an essential singularity, e.g., $e^{-1/z}$ near $z = 0$. Of course, multiplication by a power of z does not remove the singularity, and the Laurent series contains all negative powers of z :

$$e^{-1/z} = \sum_{j=0}^{\infty} \frac{(-1)^j}{j! z^j}; \quad (z \neq 0) \quad (1.4)$$

Eq. (1.4) is fundamentally distinct from the first examples. This can be seen by trying to calculate the function from its expansion for say, $z = 10^{-10}$: (1.1) provides the desired value very quickly, while (1.4), also a convergent series, is virtually unusable. Mathematically, we can check that now, if M is fixed and z tends to zero through positive values then

$$e^{-1/z} - \sum_{j=0}^M \frac{(-1)^j}{j! z^j} \gg z^{-M+1}, \quad \text{as } z \rightarrow 0^+ \quad (1.5)$$

where \gg means much larger than. In this sense, the more terms of the series we keep, the worse the error is! The Laurent series (1.4) is convergent, but **antiasymptotic**: the terms of the expansion get larger and larger as $z \rightarrow 0$. The function needs to be calculated there in a different way, and there are certainly many good ways. Surprisingly perhaps, the exponential, together with related functions such as log, sin (and powers, since we prefer the notation x to $e^{\ln x}$) are the only ones that we need in order to represent many complicated functions, asymptotically. This fact has been noted already by Hardy who wrote [38], “No function has yet presented itself in analysis the laws of whose increase, in so far as they can be stated at all, cannot be stated, so to say, in logarithmico-exponential terms.” This reflects some important fact about the relation between asymptotic expansions and functions which will be clarified in §4.9.

If we need to calculate $\Gamma(x)$ for very large x , the Taylor series about one given point would not work since the radius of convergence is finite (due to poles on \mathbb{R}^-). Instead we have Stirling’s series,

$$\ln(\Gamma(x)) \sim (x - 1/2) \ln x - x + \frac{1}{2} \ln(2\pi) + \sum_{j=1}^{\infty} c_j x^{-2j+1}, \quad x \rightarrow +\infty \quad (1.6)$$

where $2j(2j-1)c_j = B_{2j}$ and $\{B_{2j}\}_{j \geq 1} = \{1/6, -1/30, 1/42, \dots\}$ are Bernoulli numbers. This expansion is *asymptotic* as $x \rightarrow \infty$: successive terms get

smaller and smaller. Stopping at $j = 3$ we get $\Gamma(6) \approx 120.00000086$ while $\Gamma(6) = 120$. Yet, the expansion in (1.6) cannot converge to $\ln(\Gamma(x))$, and in fact, it has to have zero radius of convergence, since $\ln(\Gamma(x))$ is singular at all $x \in -\mathbb{N}$ (why is this an argument?).

Unlike asymptotic expansions, convergent but antiasymptotic expansions do not contain manifest, detailed information. Of course, this is not meant to understate the value of convergent representations or to advocate for uncontrolled approximations.

1.1a Asymptotic expansions

An asymptotic expansion of a function f at a point t_0 , usually dependent on the direction in the complex plane along which t_0 is approached, is a formal series¹ of simpler functions f_k ,

$$\tilde{f}(t) = \sum_{k=0}^{\infty} f_k(t) \quad (1.7)$$

in which each successive term is much smaller than its predecessors. For instance if the limiting point is t_0 , approached from the right along the real line, this requirement is written

$$f_{k+1}(t) = o(f_k(t)) \quad (\text{or } f_{k+1}(t) \ll f_k(t)) \text{ as } t \rightarrow t_0^+ \quad (1.8)$$

meaning

$$\lim_{t \rightarrow t_0^+} f_{k+1}(t)/f_k(t) = 0 \quad (1.9)$$

We will often use the variable x when the limiting point is $+\infty$ and z when the limiting point is zero.

Note 1.10 *It is seen that no f_k can vanish; in particular, 0, the zero series, is **not** an asymptotic expansion.*

1.1b Functions asymptotic to an expansion, in the sense of Poincaré

The relation $f \sim \tilde{f}$ between an actual function and a formal expansion is defined as a sequence of limits:

¹That is, there are no convergence requirements. More precisely, formal series are sequences of functions $\{f_k\}_{k \in \mathbb{N}}$, written as infinite sums, with the operations defined as for convergent series; see also §1.1c.

Definition 1.11 A function f is asymptotic to the formal series \tilde{f} as $t \rightarrow t_0^+$ if

$$f(t) - \sum_{k=0}^N \tilde{f}_k(t) = f(t) - \tilde{f}^{[N]}(t) = o(\tilde{f}_N(t)) \quad (\forall N \in \mathbb{N}) \quad (1.12)$$

Condition (1.12) can be written in a number of equivalent ways, useful in applications.

Proposition 1.13 If $\tilde{f} = \sum_{k=0}^{\infty} \tilde{f}_k(t)$ is an asymptotic series as $t \rightarrow t_0^+$ and f is a function asymptotic to it, then the following characterizations are equivalent to each other and to (1.12).

(i)

$$f(t) - \sum_{k=0}^N \tilde{f}_k(t) = O(\tilde{f}_{N+1}(t)) \quad (\forall N \in \mathbb{N}) \quad (1.14)$$

where $g(t) = O(h(t))$ means $\limsup_{t \rightarrow t_0^+} |g(t)/h(t)| < \infty$.

(ii)

$$f(t) - \sum_{k=0}^N \tilde{f}_k(t) = \tilde{f}_{N+1}(t)(1 + o(1)) \quad (\forall N \in \mathbb{N}) \quad (1.15)$$

(iii) There is a function $\nu : \mathbb{N} \mapsto \mathbb{N}$ such that $\nu(N) \geq N$ and

$$f(t) - \sum_{k=0}^{\nu(N)} \tilde{f}_k(t) = O(\tilde{f}_{N+1}(t)) \quad (\forall N \in \mathbb{N}) \quad (1.16)$$

Condition (iii) seems strictly weaker, but it is not. It allows us to use less accurate estimates of remainders, provided we can do so to all orders.

PROOF We only show (iii), the others being immediate. Let $N \in \mathbb{N}$. We have

$$\begin{aligned} & \frac{1}{f_{N+1}(t)} \left(f(t) - \sum_{k=0}^N \tilde{f}_k(t) \right) \\ &= \frac{1}{f_{N+1}(t)} \left(f(t) - \sum_{k=0}^{\nu(N)} \tilde{f}_k(t) \right) + \sum_{j=N+1}^{\nu(N)} \frac{f_j(t)}{f_{N+1}(t)} = O(1) \end{aligned} \quad (1.17)$$

since in the last sum in (1.17) the number of terms is fixed, and thus the sum converges to 1 as $t \rightarrow t_0^+$. \square

Simple examples of asymptotic expansions are

$$\sin z \sim z - \frac{z^3}{6} + \dots + \frac{(-1)^n z^{2n+1}}{(2n+1)!} + \dots \quad (|z| \rightarrow 0) \tag{1.18}$$

$$f(z) = \sin z + e^{-\frac{1}{z}} \sim z - \frac{z^3}{6} + \dots + \frac{(-1)^n z^{2n+1}}{(2n+1)!} + \dots \quad (z \rightarrow 0^+) \tag{1.19}$$

$$e^{-1/z} \int_1^{1/z} \frac{e^t}{t} dt \sim \sum_{k=0}^{\infty} k! z^{k+1} \quad (z \rightarrow 0^+) \tag{1.20}$$

The series on the right side of (1.18) converges to $\sin z$ for any $z \in \mathbb{C}$ and it is asymptotic to it for small $|z|$. The series in the second example converges for any $z \in \mathbb{C}$ but not to f . In the third example the series is nowhere convergent; in short it is a *divergent* series. It can be obtained by repeated integration by parts:

$$\begin{aligned} f_1(x) &:= \int_1^x \frac{e^t}{t} dt = \frac{e^x}{x} - e + \int_1^x \frac{e^t}{t^2} dt \\ &= \dots = \frac{e^x}{x} + \frac{e^x}{x^2} + \frac{2e^x}{x^3} + \dots + \frac{(n-1)!e^x}{x^n} + C_n + n! \int_1^x \frac{e^t}{t^{n+1}} dt \end{aligned} \tag{1.21}$$

with $C_{n+1} = -e \sum_{j=0}^n j!$. For the last term we have

$$\lim_{x \rightarrow \infty} \frac{\int_1^x \frac{e^t}{t^{n+1}} dt}{\frac{e^x}{x^{n+1}}} = 1 \tag{1.22}$$

(by L'Hospital) and (1.20) follows.

Note 1.23 *The constant C_n cannot be included in (1.20) using the definition (1.12), since its contribution vanishes in any of the limits implicit in (1.12).*

By a similar calculation,

$$f_2(x) = \int_2^x \frac{e^t}{t} dt \sim e^x \tilde{f}_0 = \frac{e^x}{x} + \frac{e^x}{x^2} + \frac{2e^x}{x^3} + \dots + \frac{n!e^x}{x^{n+1}} + \dots \quad \text{as } x \rightarrow +\infty \tag{1.24}$$

and now, unlike the case of (1.18) versus (1.19) there is no obvious function to prefer, insofar as asymptoticity goes, on the left side of the expansion.

Stirling's formula (1.6) is another example of a divergent asymptotic expansion.

Remark 1.25 *Asymptotic expansions cannot be added, in general. Otherwise, since on the one hand $f_1 - f_2 = \int_1^2 e^s s^{-1} ds = 3.0591\dots$, and on the other hand both f_1 and f_2 are asymptotic to the same expansion, we would have to conclude that $3.0591\dots \sim 0$. This is one reason for considering, for restricted expansions, a weaker asymptoticity condition; see §1.1c.*

Examples of expansions that are *not asymptotic* are (1.4) for small z , or

$$\sum_{k=0}^{\infty} \frac{x^{-k}}{k!} + e^{-x} \quad (x \rightarrow +\infty) \quad (1.26)$$

(because of the exponential term, this is not an ordered *simple series* satisfying (1.8)). Note however expansion (1.26), *does* satisfy all requirements in the *left* half-plane, if we write e^{-x} in the first position.

Remark 1.27 Sometimes we encounter oscillatory expansions such as $\sin x(1 + a_1x^{-1} + a_2x^{-2} + \dots)$ (*) for large x , which, while very useful, have to be understood differently. They are not asymptotic expansions, as we saw in Note 1.10. Furthermore, usually the approximation itself is expected to fail near zeros of \sin . We will discuss this question further in §3.5c.

1.1c Asymptotic power series

A special role is played by series in *powers* of a small variable, such as

$$\tilde{S} = \sum_{k=0}^{\infty} c_k z^k, \quad z \rightarrow 0^+ \quad (1.28)$$

With the transformation $z = t - t_0$ (or $z = x^{-1}$) the series can be centered at t_0 (or $+\infty$, respectively).

Definition 1.29 (Asymptotic power series) *A function is asymptotic to a series as $z \rightarrow 0$, in the sense of power series if*

$$f(z) - \sum_{k=0}^N c_k z^k = O(z^{N+1}) \quad (\forall N \in \mathbb{N}) \quad \text{as } z \rightarrow 0 \quad (1.30)$$

Remark 1.31 If f has an asymptotic expansion as a power series, it is asymptotic to it in the sense of power series as well.

However, the converse is not true, unless all c_k are nonzero.

For now, whenever confusions are possible, we will use a different symbol, \sim_p , for asymptoticity in the sense of power series.

The asymptotic **power series** at zero in \mathbb{R} of e^{-1/z^2} is the zero series. However, the asymptotic *expansion* of e^{-1/z^2} cannot be just zero.

1.1d Operations with asymptotic power series

Addition and multiplication of asymptotic power series are defined as in the convergent case:

$$A \sum_{k=0}^{\infty} c_k z^k + B \sum_{k=0}^{\infty} d_k z^k = \sum_{k=0}^{\infty} (Ac_k + Bd_k) z^k$$

$$\left(\sum_{k=0}^{\infty} c_k z^k\right) \left(\sum_{k=0}^{\infty} d_k z^k\right) = \sum_{k=0}^{\infty} \left(\sum_{j=0}^k c_j d_{k-j}\right) z^k$$

Remark 1.32 If the series \tilde{f} is convergent and f is its sum, $f = \sum_{k=0}^{\infty} c_k z^k$, (note the ambiguity of the sum notation), then $f \sim_p \tilde{f}$.

The proof follows directly from the definition of convergence.

The proof of the following lemma is immediate:

Lemma 1.33 (Algebraic properties of asymptoticity to a power series)

If $f \sim_p \tilde{f} = \sum_{k=0}^{\infty} c_k z^k$ and $g \sim_p \tilde{g} = \sum_{k=0}^{\infty} d_k z^k$, then

(i) $Af + Bg \sim_p A\tilde{f} + B\tilde{g}$

(ii) $fg \sim_p \tilde{f}\tilde{g}$

Corollary 1.34 (Uniqueness of the asymptotic series to a function)

If $f(z) \sim_p \sum_{k=0}^{\infty} c_k z^k$ as $z \rightarrow 0$, then the c_k are unique.

PROOF Indeed, if $f \sim_p \sum_{k=0}^{\infty} c_k z^k$ and $f \sim_p \sum_{k=0}^{\infty} d_k z^k$, then, by Lemma 1.33 we have $0 \sim_p \sum_{k=0}^{\infty} (c_k - d_k) z^k$ which implies, inductively, that $c_k = d_k$ for all k . □

Algebraic operations with asymptotic power series are limited too. Division of asymptotic power series is not always possible. For instance, $e^{-1/z^2} \sim_p 0$ for small z in \mathbb{R} while $1/\exp(-1/z^2)$ has no asymptotic power series at zero.

1.1d.1 Integration and differentiation of asymptotic power series

Asymptotic relations can be integrated termwise as Proposition 1.35 below shows.

Proposition 1.35 Assume f is integrable near $z = 0$ and that

$$f(z) \underset{p}{\sim} \tilde{f}(z) = \sum_{k=0}^{\infty} c_k z^k$$

Then

$$\int_0^z f(s) ds \underset{p}{\sim} \int_0^z \tilde{f}(s) ds := \sum_{k=0}^{\infty} \frac{c_k z^{k+1}}{k+1}$$

PROOF This follows from the fact that $\int_0^z o(s^n) ds = o(z^{n+1})$ as it can be seen by straightforward inequalities. □

Differentiation is a different issue. Many simple examples show that asymptotic series cannot be freely differentiated. For instance $e^{-1/z^2} \sin e^{1/z^4} \sim_p 0$ as $z \rightarrow 0$ on \mathbb{R} , but the derivative is unbounded.

1.1d.2 Asymptotics in regions in \mathbb{C}

Asymptotic power series of analytic functions can be differentiated if they hold in a region which is not too rapidly shrinking. This is so, since the derivative is expressible as an integral by Cauchy’s formula. Such a region is often a sector or strip in \mathbb{C} , but can be allowed to be thinner:

Proposition 1.36 *Let $M \geq 0$ and denote*

$$S_a = \{x : |x| \geq R, \quad |x|^M |\text{Im}(x)| \leq a\}$$

Assume f is continuous in S_a and analytic in its interior, and

$$f(x) \underset{p}{\sim} \sum_{k=0}^{\infty} c_k x^{-k} \quad \text{as } x \rightarrow \infty \text{ in } S_a$$

Then, for all $a' \in (0, a)$ we have

$$f'(x) \underset{p}{\sim} \sum_{k=0}^{\infty} (-k c_k) x^{-k-1} \quad \text{as } x \rightarrow \infty \text{ in } S_{a'}$$

PROOF Here, Proposition 1.13 (iii) will come in handy. Let $\nu(N) = N + M$. By the asymptoticity assumptions, for any N there is some constant $C(N)$ such that $|f(x) - \sum_{k=0}^{\nu(N)} c_k x^{-k}| \leq C(N) |x|^{-\nu(N)-1}$ (*) in S_a .

Let $a' < a$, take x large enough, and let $\rho = \frac{1}{2}(a - a')|x|^{-M}$; then check that $\mathbb{D}_\rho = \{x' : |x - x'| \leq \rho\} \subset S_a$. We have, by Cauchy’s formula and (*),

$$\begin{aligned} \left| f'(x) - \sum_{k=0}^{\nu(N)} (-k c_k) x^{-k-1} \right| &= \left| \frac{1}{2\pi i} \oint_{\partial \mathbb{D}_\rho} \left(f(s) - \sum_{k=0}^{\nu(N)} c_k s^{-k} \right) \frac{ds}{(s - x)^2} \right| \\ &\leq \frac{C(N)}{(|x| - 1)^{\nu(N)+1}} \frac{1}{2\pi} \oint_{\partial \mathbb{D}_\rho} \frac{d|s|}{|s - x|^2} \leq \frac{2C(N)}{|x|^{\nu(N)+1} \rho} = \frac{4C(N)}{a - a'} |x|^{-N-1} \end{aligned} \quad (1.37)$$

and the result follows. □

Clearly, this result can be used as a tool to show differentiability of asymptotics in wider regions.

Note 1.38 Usually, we can determine from the context whether \sim or \sim_p should be used. Often in the literature, it is left to the reader to decide which notion to use. After we have explained the distinction, we will do the same, so as not to complicate notation.

Exercise 1.39 Consider the following integral related to the error function

$$F(z) = e^{z^{-2}} \int_0^z s^{-2} e^{-s^{-2}} ds$$

It is clear that the integral converges at the origin, if the origin is approached through real values (see also the change of variable below); thus we *define* the integral to $z \in \mathbb{C}$ as being taken on a curve γ with $\gamma'(0) > 0$, and extend F by $F(0) = 0$. The resulting function is analytic in $\mathbb{C} \setminus 0$; see [Exercise 3.8](#).

What about the behavior at $z = 0$? It depends on the direction in which 0 is approached! Substituting $z = 1/x$ and $s = 1/t$ we get

$$E(x) = e^{x^2} \int_x^\infty e^{-t^2} dt =: \frac{\sqrt{\pi}}{2} e^{x^2} \operatorname{erfc}(x) \quad (1.40)$$

Check that if $f(x)$ is continuous on $[0, 1]$ and differentiable on $(0, 1)$ and $f'(x) \rightarrow L$ as $x \downarrow 0$, then f is differentiable to the right at zero and this derivative equals L . Use this fact, Proposition 1.36 and induction to show that the Taylor series at 0^+ of $F(z)$ is indeed given by (3.7).

1.2 Formal and actual solutions

Few calculational methods have longer history than successive approximation. Suppose ϵ is small and we want to solve the equation $y - y^5 = \epsilon$. Looking for a small solution y , we see that $y^5 \ll y$ and then, placing the smaller term y^5 on the right, to be discarded to leading order, we define the approximation scheme

$$y_{n+1} = \epsilon + y_n^5; \quad y_0 = 0 \quad (1.41)$$

At every step, we use the previously obtained value to improve the accuracy; we expect better and better approximation of y by y_n , as n increases. We have $y_1 = \epsilon$, $y_2 = \epsilon + y_1^5 = \epsilon + \epsilon^5$. Repeating indefinitely, we get

$$y \approx \epsilon + \epsilon^5 + 5\epsilon^9 + 35\epsilon^{13} + 285\epsilon^{17} + 2530\epsilon^{21} + \dots \quad (1.42)$$

See also [§3.8](#).

Exercise 1.43 Show that the series above converges for to a solution y , if $|\epsilon| < 4 \cdot 5^{-5/4}$. (Hint: one way is to use implicit function theorem.)

Regular differential equations can be locally solved much in the same way. Consider the Painlevé P_1 equation

$$y'' = y^2 + z \quad (1.44)$$

near $z = 0$ with $y(0) = 0$ and $y'(0) = b$. If y is small like some power of z , then y'' is far larger than y^2 . To set up the approximation scheme, we thus keep y on the right side, and integrate (1.44) using the initial condition to get

$$y(z) = bz + \frac{z^3}{6} + \int_0^z \int_0^s y(t)^2 dt ds \tag{1.45}$$

We now replace y by y_{n+1} on the left side, and by y_n on the right side, taking again $y_0 = 0$.

Then $y_1 = bz + z^3/6$. By looking at y_1 , we expect $y - y_1 = O(z^4)$. Indeed, $y_0 - y \approx y_0 - y_1 = O(z)$ and we have thus far discarded the iterated integral of $O(z^2)$. Continuing, $y_2 - y = O(z^6)$ and so on.

In this approximation scheme too it can be shown without much effort that $y_n \rightarrow y$, an actual solution of the problem.

$$y = bz + \frac{z^3}{6} + \frac{b^2 z^2}{12} + \frac{bz^6}{90} + \dots$$

Let us look at the equation

$$f' - f = -x^{-1}, \quad x \rightarrow +\infty \tag{1.46}$$

If f is small like an inverse power of x , then f' should be even smaller, and we can apply again successive approximations to the equation written in the form

$$f = x^{-1} + f' \tag{1.47}$$

To leading order $f \approx f_1 = 1/x$; we then have $f \approx f_2 = 1/x + (1/x)' = 1/x - 1/x^2$ and now if we repeat the procedure indefinitely we get

$$f \approx \frac{1}{x} - \frac{1}{x^2} + \frac{2}{x^3} - \frac{6}{x^4} + \dots - \frac{(-1)^n n!}{x^{n+1}} + \dots \tag{1.48}$$

Something must have gone wrong here. We do not get a solution (in any obvious meaning) to the problem: for no value of x is this series convergent. What distinguishes the first two examples from the last one? In the first two, the next approximation was obtained from the previous one by algebraic operations and integration. These processes are regular, and they produce, at least under some restrictions on the variables, convergent expansions. We have, e.g., $\int \dots \int x = x^n/n!$. But in the last example, we iterated upon differentiation a regularity-reducing operation. We have $(1/x)^{(n)} = (-1)^n n!/x^{n+1}$. The series in (1.48) is only a *formal* solution of (1.47), in the sense that it satisfies the equation, provided we perform the operations formally, term by term.

1.2a Limitations of representation of functions by expansions

Prompted by the need to eliminate apparent paradoxes, mathematics has been formulated in a precise language with a well-defined set of axioms [59], [56]

within set theory. In this language, a function is defined as a *set of ordered pairs* (x, y) such that *for every x there is only one pair with x as the first element*². All this can be written precisely and it is certainly foundationally satisfactory, since it uses arguably more primitive objects: sets.

A tiny subset of these general functions can arise as unique solutions to well-defined problems, however. Indeed, on the one hand it is known that there is no specific way to distinguish two arbitrary functions based on their intrinsic properties alone³. By the same argument, clearly it cannot be possible to represent general functions by constructive expansions. On the other hand, a function which is known to be the unique solution to a specific problem can a fortiori be distinguished from any other function.

In some sense, most functions just exist in an unknowable realm, and only their collective presence has mathematical consequences. We can usefully restrict the study of functions to those which do arise in specific problems, and hope that they have, in general, better properties than arbitrary ones. For instance, solutions of specific equations, such as systems of linear or nonlinear ODEs or difference equations with meromorphic coefficients, near a regular or singular point, can be described completely in terms of their expansion at such a point (more precisely, they are completely described by their *transseries*, a generalization of series described later).

Conversely in some sense, we can write formal expansions without a natural function counterpart. The formal expression

$$\sum_{q \in \mathbb{Q}} \frac{1}{x + q}; \quad x \notin \mathbb{Q} \tag{1.49}$$

(true, this is not an asymptotic series whatever x is) cannot have a nonconstant, meaningful sum, since the expression is formally q -periodic for any $q \in \mathbb{Q}$ and the sum should preserve this basic feature. Nonconstant functions with arbitrarily small periods are not Lebesgue measurable [51]. Since it is known that existence of nonmeasurable functions can be proved only by using some form of the axiom of choice, no definable (such as “the sum of (1.49)”) nonmeasurable function can be exhibited.

A good correspondence between functions and expansions is possible only by carefully restricting both. We will restrict the analysis to functions and expansions arising in differential or difference equations, and some few other concrete problems.

*

²Here x, y are themselves sets, and $(x, y) := \{x, \{x, y\}\}$; x is in the domain of the function and y is in its range.

³More precisely, in order to select one function out of an arbitrary, *unordered* pair of functions, some form of the *axiom of choice* [56] is needed.

Convergent series relate to their sums in a relations-preserving way. Can we associate to a divergent series a unique function by some generalized property-preserving summation process? The answer is no in general, as we have seen, and yes in many practical cases. Exploring this question will carry us through a number of interesting problems.

*

In [36], Euler investigated the question of the possible sum of the formal series $s = 1 - 2 + 6 - 24 + 120 \cdots$, in fact extended to

$$\tilde{f} := \sum_{k=0}^{\infty} k!(-z)^{k+1}, \quad z > 0 \quad (1.50)$$

In effect, Euler notes that \tilde{f} satisfies the equation

$$z^2 y' + y = z \quad (1.51)$$

and thus $\tilde{f} = e^{1/z} \text{Ei}(-1/z) + C e^{1/z}$ (see Fig. 1.1 on p. 13), for some C , where C must vanish since the series is formally small as $z \rightarrow 0^+$. Then, $\tilde{f} = e^{1/z} \text{Ei}(-1/z)$, and in particular $s = e \text{Ei}(-1)$. What does this argument show? At the very least, it proves that *if* there is a summation process capable of summing (1.50) to a function, in a way compatible with basic operations and properties, the function can only be $e^{1/z} \text{Ei}(-1/z)$. In this sense, the sum is independent of the summation method.

Factorially divergent were already widely used at the turn of the 19th century for very precise astronomical calculations. As the variable, say $1/x$, becomes small, the first few terms of the expansion should provide a good approximation of the function. Taking for instance $x = 100$ and 5 terms in the asymptotic expansions (1.21) and (1.24) we get the value $2.715552711 \cdot 10^{41}$, a very good approximation of $f_1(100) = 2.715552745 \dots \cdot 10^{41}$.

However, in using divergent series, there is a threshold in the accuracy of approximation, as it can be seen by comparing (1.21) and (1.24). The functions f_1 and f_2 have the *same asymptotic series*, but differ by a constant, which is exponentially smaller than each of them. The expected relative error in using a truncation of the series to evaluate the function cannot be better than exponentially small, at least for one of them. As we shall see, exponentially small relative errors (that is, absolute errors of order one) can be, for both of them, achieved by truncating the series at an optimal number of terms, *dependent on x (optimal truncation)*; see Note 4.134 below. The absolute error in calculating $f_3(x) := \text{Ei}(x)$ by optimal truncations is even smaller, of order $x^{-1/2}$. Still, for fixed x , in such a calculation there is a built-in ultimate error, a final nonzero distance between the series and the function we want to calculate.

Cauchy [14] proved that optimal truncation in Stirling's formula gives errors of the order of magnitude of the least term, exponentially small relative to the function calculated. Stokes refined Cauchy summation to the least term, and

220

DE SERIEBUS

§. 19. Investigemus nunc etiam analytice huius seriei valorem, eam vero in latiori sensu accipiamus: fit igitur

$$s = x - 1x^2 + 2x^3 - 6x^4 + 24x^5 - 120x^6 + \text{etc.}$$

quae differentiata dabit:

$$\frac{ds}{dx} = 1 - 2x + 6xx - 24x^3 + 120x^4 - \text{etc.} = \frac{x-s}{x^2}$$

unde fit $ds + \frac{ds}{x} = \frac{dx}{x}$, cuius aequationis, si e fumatur pro numero, cuius logarithmus hyperbolicus est $= 1$, integrale erit $e^{-1:s} s = \int \frac{e^{-1:s} dx}{x}$ et $s = e^{1:s} \int \frac{e^{-1:s} dx}{x}$.

Casu ergo quo $x = 1$ erit $1 - 1 + 2 - 6 + 24 - 120 + \text{etc.}$

$= e^{\int \frac{e^{-1:s} dx}{x}}$. Exprimit ergo haec series aream lineae curvae, cuius natura inter abscissam x et y hac

continetur aequatione $y = \frac{e \cdot e^{-1:s}}{x}$, si abscissa x

ponatur $= 1$: seu erit $y = \frac{e}{e^{1:s}}$. Haec autem curva

ita est comparata, ut posito $x = 0$ fiat $y = 0$; si autem fit $x = 1$, erit $y = 1$: medii vero applicatae valores ita se habebant, ut

si fit

FIGURE 1.1: L. Euler, De seriebus divergentibus, *Novi Commentarii Academiae Scientiarum Petropolitanae* (1754/55) 1760, p. 220.

relied on it to discover the “Stokes phenomenon:” the behavior of a function described by a divergent series must change qualitatively as the direction in \mathbb{C} varies, and furthermore, the change is first (barely) visible at what we now call Stokes rays.

But a general procedure of “true” summation was absent at the time. Abel, discoverer of a number of summation procedures of divergent series, labeled divergent series “an invention of the devil.”

Later, the view of divergent series as somehow linked to specific functions and encoding their properties was abandoned (together with the concept of functions as specific rules). This view was replaced by the rigorous notion of an *asymptotic series*, associated instead to a vast family of functions via the rigorous Poincaré definition 1.11, which is precise and general, but specificity is lost even in simple cases.

1.2b Summation of a divergent series

Another way to determine (heuristically) the sum of Euler’s series, or, equivalently, of (1.48) is to replace $n!$ in the series by its integral representation

$$n! = \int_0^\infty e^{-t} t^n dt$$

We get

$$\int_0^\infty \sum_{n=0}^\infty e^{-t} t^n x^{-n-1} dt = \int_0^\infty \frac{e^{-np}}{1+p} dp \quad (1.52)$$

provided we can interchange summation and integration, and we sum the geometric series to $1/(1+p)$ for all values of p , not only for $|p| < 1$.

Upon closer examination, we see that another way to view the formal calculation leading to (1.52) is to say that we first performed a term-by-term inverse Laplace transform (cf. §2.2) of the series (the inverse Laplace transform of $n!x^{-n-1}$ being p^n), summed the p -series for small p (to $(1+p)^{-1}$) *analytically continued* this sum on the whole of \mathbb{R}^+ and then took the Laplace transform of this result. Up to analytic continuations and ordinary convergent summations, what has been done in fact is the combination Laplace inverse-Laplace transform, which is the identity. In this sense, the emergent function should inherit the (many) formal properties that are preserved by analytic continuation and convergent summation. In particular, (1.52) is a solution of (1.46). The steps we have just described define Borel summation, which applies precisely when the above steps succeed.

Some elements of Écalle’s theory

In the 1980s Écalle discovered a vast class of functions, closed under usual operations (algebraic ones, differentiation, composition, integration and function inversion) whose properties are, at least in principle, easy to analyze:

the analyzable functions. Analyzable functions are in a one-to-one isomorphic correspondence with generalized summable expansions, *transseries*.

What is the closure of simple functions under the operations listed? That is not easy to see if we attempt to construct the closure on the function side. Let's see what happens by repeated application of two operations, taking the reciprocal and integration.

$$1 \xrightarrow{f} x \xrightarrow{\frac{1}{\cdot}} x^{-1} \xrightarrow{f} \ln x$$

and $\ln x$ is not expressible in terms of powers, and so it has to be taken as a primitive object. Further,

$$\ln x \xrightarrow{\frac{1}{\cdot}} \frac{1}{\ln x} \xrightarrow{f} \int \frac{1}{\ln x} \tag{1.53}$$

and, within functions we would need to include the last integral as yet another primitive object, since the integral is nonelementary, and in particular it cannot be expressed as a finite combination of powers and logs. In this way, we generate an endless list of new objects.

Transseries. The way to obtain analyzable functions was in fact to first construct *transseries*, the closure of formal series under operations, which turns out to be a far more manageable task, and then find a general, well-behaved, summation procedure.

Transseries are surprisingly simple. They consist, roughly, in all formally asymptotic expansions in terms of powers, exponentials and logs, of ordinal length, with coefficients which have at most power-of-factorial growth. For instance, as $x \rightarrow \infty$, integrations by parts in (1.53), formally repeated infinitely many times, yields

$$\int \frac{1}{\ln x} = x \sum_{k=0}^{\infty} \frac{k!}{(\ln x)^{k+1}}$$

(still an expansion in x and $1/\ln x$, but now a divergent one). Other examples are:

$$e^{e^x + x^2} + e^{-x} \sum_{k=0}^{\infty} \frac{k!(\ln x)^k}{x^k} + e^{-x \ln x} \sum_{k=-1}^{\infty} \frac{k!2^{2^k}}{x^{k/3}} \quad x \rightarrow +\infty$$

$$\sum_{k=0}^{\infty} e^{-kx} \left(\sum_{j=0}^{\infty} \frac{c_{kl}}{x^k} \right)$$

Note how the terms are ordered decreasingly, with respect to \gg (far greater than) from left to right. Transseries are constructed so that they are *finitely generated*, that is they are effectively (multi)series in a finite number of “bricks” (transmonomials), simpler combinations of exponentials powers and logs. The *generators* in the first and third transseries are $1/x$ and e^{-x} . Transseries contain, order by order, manifest asymptotic information.

Transseries, as constructed by Écalle, are the closure of series under a number of operations, including

- (i) Algebraic operations: addition, multiplication and their inverses.
- (ii) Differentiation and integration.
- (iii) Composition and functional inversion.

However, operations (i), (ii) and (iii) are far from sufficient; for instance differential equations cannot be solved through (i)–(iii). Indeed, most ODEs *cannot* be solved by *quadratures*, i.e., by finite combinations of integrals of simple functions, but by limits of these operations. Limits though are not easily accommodated in the construction. Instead we can allow for

- (iv) Solution of fixed point problems of *formally contractive mappings*, see §3.8.

Operation (iv) was introduced by abstracting from the way problems with a small parameter⁴ are solved by successive approximations.

Theorem. Transseries are closed under (i)–(iv).

This will be formulated precisely and proved in §4 and §4.9; it means many problems can be solved within transseries. It seems unlikely though that even with the addition of (iv) do we obtain all that is needed to solve asymptotic problems; more needs to be understood.

Analyzable functions, BE summation. To establish a one-to-one isomorphic correspondence between a class of transseries and functions, Écalle also vastly generalized Borel summation.

Borel-Écalle (BE) summation, when it applies, extends usual summation, it does not depend on how the transseries was obtained, while preserving all basic relations and operations. The sum of a BE summable transseries is, by definition, an analyzable function.

BE summable transseries are known to be closed under operations (i)–(iii) but not yet (iv). BE summability has been shown to apply generic systems of linear or nonlinear ODEs, PDEs (including the Schrödinger equation, Navier-Stokes) etc., quantum field theory, KAM (Kolmogorov-Arnold-Moser) theory, and so on. Some concrete theorems will be given later.

The representation by transseries is effective, the function associated to a transseries closely following the behavior expressed in the successive, ordered, terms of its transseries.

Determining the transseries of a function f is the “analysis” of f , and transseriable functions are “analyzable,” while the opposite process, reconstruction by BE summation of a function from its transseries is known as “synthesis.”

⁴The small parameter could be the independent variable itself.

We have the following diagram

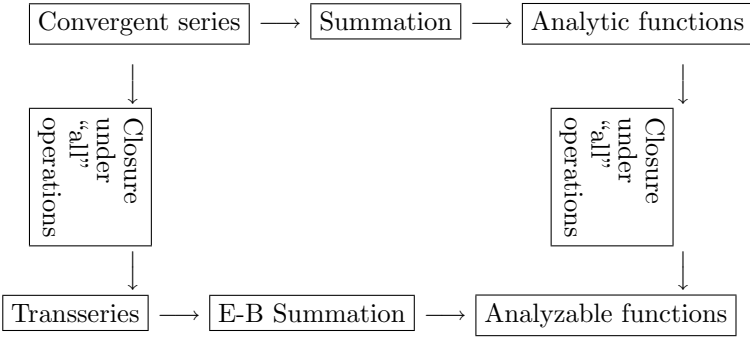

This is the only known way to close functions under the listed operations.

Chapter 2

Review of some basic tools

2.1 The Phragmén-Lindelöf theorem

This result is very useful in obtaining information about the size of a function in a sector, when the only information available is on the edges. There are other formulations, specific other unbounded regions, such as strips and half-strips. We use the following setting.

Theorem 2.1 (Phragmén-Lindelöf) *Let U be the open sector between two rays¹, forming an angle π/β , $\beta > 1/2$. Assume f is analytic in U , and continuous on its closure, and for some $C_1, C_2, M > 0$ and $\alpha \in (0, \beta)$ it satisfies the estimates*

$$|f(z)| \leq C_1 e^{C_2 |z|^\alpha} \text{ for } z \in U \text{ and } |f(z)| \leq M \text{ for } z \in \partial U \quad (2.2)$$

Then

$$|f(z)| \leq M \text{ for all } z \in U \quad (2.3)$$

PROOF By a rotation we can make $U = \{z : 2|\arg z| < \pi/\beta\}$. Making a cut in the complement of U we can define an analytic branch of the log in U and, with it, an analytic branch of z^β . By taking $f_1(z) = f(z^{1/\beta})$, we can assume without loss of generality that $\beta = 1$ and $\alpha \in (0, 1)$ and then $U = \mathbb{H}$, the open right half-plane. Let $\alpha' \in (\alpha, 1)$ and consider the analytic function

$$g(z) = e^{-\epsilon z^{\alpha'}} f(z) \quad (2.4)$$

Since $|e^{-\epsilon z^{\alpha'}} + C_2 z^\alpha| \rightarrow 0$ as $|z| \rightarrow \infty$ in the closure $\overline{\mathbb{H}}$ of \mathbb{H} , we have, using the maximum principle, that $\max_{z \in \overline{\mathbb{H}}} |g| \leq \max_{z \in i\mathbb{R}} |g| \leq M$. Thus $|f(z)| \leq M |e^{\epsilon z^{\alpha'}}|$ for all $z \in \overline{\mathbb{H}}$ and $\epsilon > 0$ and the result follows. \square

¹The set $\{z : \arg z = \theta\}$, for some $\theta \in \mathbb{R}$ is called a ray in the direction (or of angle) θ .

Exercise 2.5 Assume f is entire, $|f(z)| \leq C_1 e^{|az|}$ in \mathbb{C} and $|f(z)| \leq C e^{-|z|}$ in a sector of opening more than π . Show that f is identically zero. (A similar statement holds under much weaker assumptions; see [Exercise 2.29](#).)

2.2 Laplace and inverse Laplace transforms

Let $p \in L^1(\mathbb{R}^+)$ (meaning that $|F|$ is integrable on $[0, \infty)$). Then the Laplace transform

$$(\mathcal{L}F)(x) := \int_0^\infty e^{-px} F(p) dp \quad (2.6)$$

is analytic in \mathbb{H} and continuous in $\overline{\mathbb{H}}$. Note that the substitution allows us to work in space of functions with the property that $F(p)e^{-|\alpha|p}$ is in L^1 , correspondingly replacing x by $x - |\alpha|$.

Proposition 2.7 If $F \in L^1(\mathbb{R}^+)$, then

- (i) $\mathcal{L}F$ is analytic \mathbb{H} and continuous on the imaginary axis $\partial\mathbb{H}$.
- (ii) $\mathcal{L}\{F\}(x) \rightarrow 0$ as $x \rightarrow \infty$ along any ray $\{x : \arg(x) = \theta\}$ if $\theta \leq \pi/2$.

Proof. (i) Continuity and analyticity are preserved by integration against a finite measure ($F(p)dp$). Equivalently, these properties follow by dominated convergence², as $\epsilon \rightarrow 0$, of $\int_0^\infty e^{-isp}(e^{-ip\epsilon} - 1)F(p)dp$ and of $\int_0^\infty e^{-xp}(e^{-p\epsilon} - 1)\epsilon^{-1}F(p)dp$, respectively, the last integral for $\operatorname{Re}(x) > 0$.

If $|\theta| < \pi/2$, (ii) follows easily from dominated convergence; for $\theta = \pi/2$ it follows from the Riemann-Lebesgue lemma; see [Proposition 3.55](#). \square

Remark 2.8 Extending F on \mathbb{R}^- by zero and using the continuity in x proved in Proposition 2.7, we have $\mathcal{L}\{F\}(it) = \int_{-\infty}^\infty e^{-ipt} F(p)dp = \hat{\mathcal{F}}F(t)$. In this sense, the Laplace transform can be identified with the (analytic continuation of) the Fourier transform, restricted to functions vanishing on a half-line.

First inversion formula

Let \mathcal{H} denote the space of analytic functions in \mathbb{H} .

Proposition 2.9 (i) $\mathcal{L} : L^1(\mathbb{R}^+) \mapsto \mathcal{H}$ and $\|\mathcal{L}F\|_\infty \leq \|F\|_1$.

- (ii) $\mathcal{L} : L^1 \mapsto \mathcal{L}(L^1)$ is invertible, and the inverse is given by

$$F(x) = \hat{\mathcal{F}}^{-1}\{\mathcal{L}F(it)\}(x) \quad (2.10)$$

for $x \in \mathbb{R}^+$ where $\hat{\mathcal{F}}$ is the Fourier transform.

²See e.g. [51]. Essentially, if the functions $|f_n| \in L^1$ are bounded uniformly in n by $g \in L^1$ and they converge pointwise (except possibly on a set of measure zero), then $\lim f_n \in L^1$ and $\lim \int f_n = \int \lim f_n$.

PROOF Part (i) is immediate, since $|e^{-xp}| \leq 1$. Part (ii) follows from Remark 2.8. \square

Lemma 2.11 (Uniqueness) *Assume $F \in L^1(\mathbb{R}^+)$ and $\mathcal{L}F(x) = 0$ for x in a set with an accumulation point in \mathbb{H} . Then $F = 0$ a.e.*

PROOF By analyticity, $\mathcal{L}F = 0$ in \mathbb{H} . The rest follows from Proposition 2.9. \square

Second inversion formula

Proposition 2.12 (i) *Assume f is analytic in an open sector $\mathbb{H}_\delta := \{x : |\arg(x)| < \pi/2 + \delta\}$, $\delta \geq 0$ and is continuous on $\partial\mathbb{H}_\delta$, and that for some $K > 0$ and any $x \in \overline{\mathbb{H}_\delta}$ we have*

$$|f(x)| \leq K(|x|^2 + 1)^{-1} \tag{2.13}$$

Then $\mathcal{L}^{-1}f$ is well defined by

$$F = \mathcal{L}^{-1}f = \frac{1}{2\pi i} \int_{-i\infty}^{+i\infty} dt e^{pt} f(t) \tag{2.14}$$

and

$$\int_0^\infty dp e^{-px} F(p) = \mathcal{L}\mathcal{L}^{-1}f = f(x) \tag{2.15}$$

We have $\|\mathcal{L}^{-1}\{f\}\|_\infty \leq K/2$ and $\mathcal{L}^{-1}\{f\} \rightarrow 0$ as $p \rightarrow \infty$.

(ii) *If $\delta > 0$, then $F = \mathcal{L}^{-1}f$ is analytic in the sector $S = \{p \neq 0 : |\arg(p)| < \delta\}$. In addition, $\sup_S |F| \leq K/2$ and $F(p) \rightarrow 0$ as $p \rightarrow \infty$ along rays in S .*

PROOF

(i) We have

$$\int_0^\infty dp e^{-px} \int_{-\infty}^\infty ids e^{ips} f(is) = \int_{-\infty}^\infty ids f(is) \int_0^\infty dp e^{-px} e^{ips} \tag{2.16}$$

$$= \int_{-i\infty}^{i\infty} f(z)(x - z)^{-1} dz = 2\pi i f(x) \tag{2.17}$$

where we applied Fubini's theorem³ and then pushed the contour of integration past x to infinity. The norm is obtained by majorizing $|f(x)e^{px}|$ by $K(|x^2| + 1)^{-1}$.

³This theorem addresses the permutation of the order of integration; see [51]. Essentially, if $f \in L^1(A \times B)$, then $\int_{A \times B} f = \int_A \int_B f = \int_B \int_A f$.

(ii) For any $\delta' < \delta$ we have, by (2.13),

$$\begin{aligned} \int_{-i\infty}^{i\infty} ds e^{ps} f(s) &= \left(\int_{-i\infty}^0 + \int_0^{i\infty} \right) ds e^{ps} f(s) \\ &= \left(\int_{-i\infty e^{-i\delta'}}^0 + \int_0^{i\infty e^{i\delta'}} \right) ds e^{ps} f(s) \end{aligned} \quad (2.18)$$

Given the exponential decay of the integrand, analyticity in (2.18) is clear. For the estimates, we note that (i) applies to $f(xe^{i\phi})$ if $|\phi| < \delta$. \square

Many cases can be reduced to (2.13) after transformations. For instance if $f_1 = \sum_{j=1}^N a_j x^{-k_j} + f(x)$, where $k_j > 0$ and f satisfies the assumptions above, then (2.14) and (2.15) apply to f_1 , since they do apply, by straightforward verification, to the finite sum. \square

Proposition 2.19 *Let F be analytic in the open sector $S_p = \{e^{i\phi}\mathbb{R}^+ : \phi \in (-\delta, \delta)\}$ and such that $|F(|x|e^{i\phi})| \leq g(|x|) \in L^1[0, \infty)$. Then $f = \mathcal{L}F$ is analytic in the sector $S_x = \{x : |\arg(x)| < \pi/2 + \delta\}$ and $f(x) \rightarrow 0$ as $|x| \rightarrow \infty, \arg(x) = \theta \in (-\pi/2 - \delta, \pi/2 + \delta)$.*

PROOF Because of the analyticity of F and the decay conditions for large p , the path of Laplace integration can be rotated by angle ϕ in $(-\delta, \delta)$ without changing $(\mathcal{L}F)(x)$ (see also §4.4d). \square

Note that without further assumptions on $\mathcal{L}F$, F is *not* necessarily analytic at $p = 0$.

2.2a Inverse Laplace space convolution

If f and g satisfy the assumptions of Proposition 2.12, then so does fg and we have

$$\mathcal{L}^{-1}(fg) = (\mathcal{L}^{-1}f) * (\mathcal{L}^{-1}g) \quad (2.20)$$

where

$$(F * G)(p) := \int_0^p F(s)G(p - s)ds \quad (2.21)$$

This formula is easily checked by taking the Laplace transform of (2.21) and justifying the change of variables $p_1 = s, p_2 = p - s$.

Note that $\mathcal{L}(pF) = (\mathcal{L}F)'$.

We can draw interesting conclusions about F from the rate of decay of $\mathcal{L}F$ alone.

Proposition 2.22 (Lower bound on decay rates of Laplace transforms)
 Assume $F \in L^1(\mathbb{R}^+)$ and for some $\epsilon > 0$ we have

$$\mathcal{L}F(x) = O(e^{-\epsilon x}) \quad \text{as } x \rightarrow +\infty \tag{2.23}$$

Then $F = 0$ on $[0, \epsilon]$.

PROOF We write

$$\int_0^\infty e^{-px} F(p) dp = \int_0^\epsilon e^{-px} F(p) dp + \int_\epsilon^\infty e^{-px} F(p) dp \tag{2.24}$$

we note that

$$\left| \int_\epsilon^\infty e^{-px} F(p) dp \right| \leq e^{-\epsilon x} \int_\epsilon^\infty |F(p)| dp \leq e^{-\epsilon x} \|F\|_1 = O(e^{-\epsilon x}) \tag{2.25}$$

Therefore

$$g(x) = \int_0^\epsilon e^{-px} F(p) dp = O(e^{-\epsilon x}) \quad \text{as } x \rightarrow +\infty \tag{2.26}$$

The function g is entire (check). Let $h(x) = e^{\epsilon x} g(x)$. Then h is entire and uniformly bounded on \mathbb{R}^+ (since by assumption, for some x_0 and all $x > x_0$ we have $h \leq C$ and by continuity $\max |h| < \infty$ on $[0, x_0]$). The function h is bounded in \mathbb{C} by $Ce^{2\epsilon|x|}$, for some $C > 0$, and it is manifestly bounded by $\|F\|_1$ for $x \in i\mathbb{R}$. By Phragmén-Lindelöf (first applied in the first quadrant and then in the fourth quadrant, with $\beta = 2, \alpha = 1$) h is bounded in $\overline{\mathbb{H}}$. Now, for $x = -s < 0$ we have

$$e^{-s\epsilon} \int_0^\epsilon e^{sp} F(p) dp \leq \int_0^\epsilon |F(p)| dp \leq \|F\|_1 \tag{2.27}$$

Once more by Phragmén-Lindelöf (again applied twice), h is bounded in the closed left half-plane thus bounded in \mathbb{C} , and it is therefore a constant. But, by the Riemann-Lebesgue lemma, $h(x) \rightarrow 0$ as $-ix \rightarrow +\infty$. Thus $g = h \equiv 0$. Noting that $g = \mathcal{L}\chi_{[0, \epsilon]} F$ the result follows from (2.11). \square

Corollary 2.28 Assume $F \in L^1$ and $\mathcal{L}F = O(e^{-Ax})$ as $x \rightarrow +\infty$ for all $A > 0$. Then $F = 0$.

PROOF This is straightforward. \square

As we see, uniqueness of the Laplace transform can be reduced to estimates.

Exercise 2.29 (*) Assume f is analytic for $|z| > z_0$ in a sector S of opening more than π and that $|f(z)| \leq Ce^{-a|z|}$ ($a > 0$) in S . Show that f is identically

zero. Compare with Exercise 2.5. Does the conclusion hold if $e^{-a|z|}$ is replaced by $e^{-a\sqrt{|z|}}$?

(Hint: take a suitable inverse Laplace transform F of f , show that F is analytic near zero and $F^{(n)}(0) = 0$ and use Proposition 2.12).

See also Example 2 in §3.6.

Chapter 3

Classical asymptotics

3.1 Asymptotics of integrals: First results

Example: Integration by parts and elementary truncation to the least term. A solution of the differential equation

$$f' - 2xf + 1 = 0 \quad (3.1)$$

is related to the complementary error function:

$$f(x) =: E(x) = e^{x^2} \int_x^\infty e^{-s^2} ds = \frac{\sqrt{\pi}}{2} e^{x^2} \operatorname{erfc}(x) \quad (3.2)$$

Let us find the asymptotic behavior of $E(x)$ for $x \rightarrow +\infty$. One very simple technique is integration by parts, done in a way in which the integrated terms become successively smaller. A decomposition is sought such that in the identity $fdg = d(fg) - gdf$ we have $gdf \ll fdg$. Although there may be no manifest perfect derivative in the integrand, we can always create one, in this case by writing $e^{-s^2} ds = -(2s)^{-1} d(e^{-s^2})$. We have

$$\begin{aligned} E(x) &= \frac{1}{2x} - \frac{e^{x^2}}{2} \int_x^\infty \frac{e^{-s^2}}{s^2} ds = \frac{1}{2x} - \frac{1}{4x^3} + \frac{3e^{x^2}}{4} \int_x^\infty \frac{e^{-s^2}}{s^4} ds = \dots \\ &= \sum_{k=0}^{m-1} \frac{(-1)^k \Gamma(k + \frac{1}{2})}{2\sqrt{\pi} x^{2k+1}} + \frac{(-1)^m e^{x^2} \Gamma(m + \frac{1}{2})}{\sqrt{\pi}} \int_x^\infty \frac{e^{-s^2}}{s^{2m}} ds \quad (3.3) \end{aligned}$$

On the other hand, we have, by L'Hospital

$$\left(\int_x^\infty \frac{e^{-s^2}}{s^{2m}} ds \right) \left(\frac{e^{-x^2}}{x^{2m+1}} \right)^{-1} \rightarrow \frac{1}{2} \text{ as } x \rightarrow \infty \quad (3.4)$$

and thus the last term in (3.3) is $O(x^{-2m-1})$. It is also clear that the remainder (the last term) in (3.3) is alternating and thus

$$\sum_{k=0}^{m-1} \frac{(-1)^k \Gamma(k + \frac{1}{2})}{2\sqrt{\pi} x^{2k+1}} \leq E(x) \leq \sum_{k=0}^m \frac{(-1)^k \Gamma(k + \frac{1}{2})}{2\sqrt{\pi} x^{2k+1}} \quad (3.5)$$

if m is even.

Remark 3.6 In Exercise 1.39, we conclude that $F(z)$ has a Taylor series at zero,

$$\tilde{F}(z) = \sum_{k=0}^{\infty} \frac{(-1)^k}{2\sqrt{\pi}} \Gamma(k + \frac{1}{2}) z^{2m+1} \quad (3.7)$$

and that $F(z)$ is C^∞ on \mathbb{R} and analytic away from zero.

Exercise 3.8 Show that $z = 0$ is an isolated singularity of $F(z)$. Using Remark 1.32, show that F is unbounded as 0 is approached along some directions in the complex plane.

Exercise 3.9 Given x , find $m = m(x)$ so that the accuracy in approximating $E(x)$ by truncated series, see (3.5), is highest. Show that this m is (approximately) the one that minimizes the m -th term of the series for the given x (the m -th term is the “least term”). For $x = 10$ the relative error in calculating $E(x)$ in this way is about $5.3 \cdot 10^{-42}\%$ (check).

Notes. (1) The series (3.7) is not related in any immediate way to the Laurent series of F at 0. Laurent series converge. Think carefully about this distinction and why the positive index coefficients of the Laurent series and the coefficients of (3.7) do not coincide.

(2) The rate of convergence of the Laurent series of F is slower as 0 is approached, quickly becoming numerically useless. By contrast, the precision gotten from (3.5) for $z = 1/x = 0.1$ is exceptionally good. However, of course the series used in (3.5) is divergent and cannot be used to calculate F exactly for $z \neq 0$, as explained in §1.2a.

3.1a Discussion: Laplace’s method for solving ODEs of the form $\sum_{k=0}^n (a_k x + b_k) y^{(k)} = 0$

Equations of the form

$$\sum_{k=0}^n (a_k x + b_k) y^{(k)} = 0 \quad (3.10)$$

can be solved through explicit integral representations of the form

$$y(x) = \int_{\mathcal{C}} e^{-xp} F(p) dp \quad (3.11)$$

with F expressible by quadratures and where \mathcal{C} is a contour in \mathbb{C} , which has to be chosen subject to the following **conditions**:

- The integral (3.11) should be convergent, together with sufficiently many x -derivatives, and not identically zero.
- The function $e^{-xp}F(p)$ should vanish with sufficiently many derivatives at the endpoints, or more generally, the contributions from the endpoints when integrating by parts should cancel out.

Then it is clear that the equation satisfied by F is first order linear homogeneous, and then it can be solved by quadratures. It is not difficult to analyze this method in general, but this would be beyond the purpose of this course. We illustrate it on Airy's equation

$$y'' = xy \tag{3.12}$$

Under the restrictions above we can check that F satisfies the equation

$$p^2F = F' \tag{3.13}$$

Then $F = \exp(p^3/3)$ and we get a solution in the form

$$\text{Ai}(x) = \frac{1}{2\pi i} \int_{\infty e^{-\pi i/3}}^{\infty e^{\pi i/3}} e^{-xp+p^3/3} dp \tag{3.14}$$

along some curve that crosses the real line. It is easy to check the conditions for $x \in \mathbb{R}^+$, except for the fact that the integral is not identically zero. We show this at the same time as finding the asymptotic behavior of the Ai function.

Solutions of differential or difference equations can be represented in the form

$$F(x) = \int_a^b e^{xg(s)} f(s) ds \tag{3.15}$$

with more regular and sometimes simpler g and f in wider generality, as it will become clear in later chapters.

3.2 Laplace, stationary phase, saddle point methods and Watson's lemma

These methods deal with the behavior for large x of integrals of the form (3.15). We distinguish three particular cases: (1) the case where all parameters are real (addressed by the so-called Laplace method); (2) the case where everything is real except for x which is purely imaginary (stationary phase method) and (3) the case when f and g are analytic (steepest descent method—or saddle point method). In this latter case, the integral may come as a contour integral along some path. In many cases, all three types of problems can be brought to a canonical form, to which Watson's lemma applies.

3.3 The Laplace method

Even when very little regularity can be assumed about the functions, we can still infer something about the large x behavior of (3.15).

Proposition 3.16 *If $g(s) \in L^\infty([a, b])$, then*

$$\lim_{x \rightarrow +\infty} \left(\int_a^b e^{xg(s)} ds \right)^{1/x} = e^{\|g\|_\infty}$$

PROOF This is because $\|g\|_{L^p} \rightarrow \|g\|_{L^\infty}$ [51]. See also the note below. \square

Note. Assume x is large and positive, and g has a unique absolute maximum at $s_0 \in [a, b]$. The intuitive idea in estimating integrals of the form (3.15) is that for large x , if s is not very near s_0 , then $\exp(xg(s_0))$ exceeds by a large amount $\exp(xg(s))$. Then the contribution of the part of the integral from the outside of a tiny neighborhood of the maximum point is negligible.

In a neighborhood of the maximum point, both f and g are very well approximated by their local expansion. For example, assume that the absolute maximum is at the left end a and $a = 0$, that $f(0) \neq 0$ and $g'(0) = -\alpha < 0$. Then,

$$\begin{aligned} \int_0^a e^{xg(s)} f(s) ds &\approx \int_0^a e^{xg(0) - \alpha x s} f(0) ds \\ &\approx f(0) e^{xg(0)} \int_0^\infty e^{-\alpha x s} ds = f(0) e^{xg(0)} \frac{1}{\alpha x} \end{aligned} \quad (3.17)$$

Watson's lemma, proved in the sequel, is perhaps the ideal way to make the previous argument rigorous, but for the moment we just convert the approximate reasoning into a proof following the discussion in the note.

Proposition 3.18 *(the case when g is maximum at one endpoint). Assume f is continuous on $[a, b]$, $f(a) \neq 0$, g is in $C^1[a, b]$ and $g' < -\alpha < 0$ on $[a, b]$. Then*

$$J_x := \int_a^b f(s) e^{xg(s)} ds = \frac{f(a) e^{xg(a)}}{x|g'(a)|} (1 + o(1)) \quad (x \rightarrow +\infty) \quad (3.19)$$

Note: Since the derivative of g enters in the final result, regularity is clearly needed.

PROOF Without loss of generality, we may assume $a = 0$, $b = 1$, $f(0) > 0$ (the complex case, $f = u + iv$, is dealt with by separately treating u and v).

Let ϵ be small enough and choose δ such that if $s < \delta$ we have $|f(s) - f(0)| < \epsilon$ and $|g'(s) - g'(0)| < \epsilon$. We write

$$\int_0^1 f(s)e^{xg(s)} ds = \int_0^\delta f(s)e^{xg(s)} ds + \int_\delta^1 f(s)e^{xg(s)} ds \tag{3.20}$$

the last integral in (3.20) is bounded by

$$\int_\delta^1 f(s)e^{xg(s)} ds \leq \|f\|_\infty e^{xg(0)} e^{x(g(\delta) - g(0))} \tag{3.21}$$

For the middle integral in (3.20) we have, for any small $\epsilon > 0$,

$$\begin{aligned} \int_0^\delta f(s)e^{xg(s)} ds &\leq (f(0) + \epsilon) \int_0^\delta e^{x[g(0) + (g'(0) + \epsilon)s]} ds \\ &\leq -\frac{e^{xg(0)}}{x} \frac{f(0) + \epsilon}{g'(0) + \epsilon} \left[1 - e^{x\delta(g'(0) + \epsilon)} \right] \end{aligned} \tag{3.22}$$

Combining these estimates, as $x \rightarrow \infty$ we thus obtain

$$\limsup_{x \rightarrow \infty} x e^{-xg(0)} \int_0^1 f(s)e^{xg(s)} ds \leq -\frac{f(0) + \epsilon}{g'(0) + \epsilon} \tag{3.23}$$

A lower bound is obtained in a similar way. Since ϵ is arbitrary, the result follows. \square

When the maximum of g is reached inside the interval of integration, sharp estimates require even more regularity.

Proposition 3.24 (*Interior maximum*) Assume $f \in C[-1, 1]$, $g \in C^2[-1, 1]$ has a unique absolute maximum (say at $x = 0$) and that $f(0) \neq 0$ (say $f(0) > 0$) and $g''(0) < 0$. Then

$$\int_{-1}^1 f(s)e^{xg(s)} ds = \sqrt{\frac{2\pi}{x|g''(0)|}} f(0)e^{xg(0)}(1 + o(1)) \quad (x \rightarrow +\infty) \tag{3.25}$$

PROOF The proof is similar to the previous one. Let ϵ be small enough and let δ be such that $|s| < \delta$ implies $|g''(s) - g''(0)| < \epsilon$ and also $|f(s) - f(0)| < \epsilon$. We write

$$\int_{-1}^1 e^{xg(s)} f(s) ds = \int_{-\delta}^\delta e^{xg(s)} f(s) ds + \int_{|s| \geq \delta} e^{xg(s)} f(s) ds \tag{3.26}$$

The last term will not contribute in the limit since by our assumptions for some $\alpha > 0$ and $|s| > \delta$ we have $g(s) - g(0) < -\alpha < 0$ and thus

$$e^{-xg(0)} \sqrt{x} \int_{|s| \geq \delta} e^{xg(s)} f(s) ds \leq 2\sqrt{x} \|f\|_\infty e^{-x\alpha} \rightarrow 0 \text{ as } x \rightarrow \infty \tag{3.27}$$

On the other hand,

$$\begin{aligned} \int_{-\delta}^{\delta} e^{xg(s)} f(s) ds &\leq (f(0) + \epsilon) \int_{-\delta}^{\delta} e^{xg(0) + \frac{x}{2}(g''(0) + \epsilon)s^2} ds \\ &\leq (f(0) + \epsilon) e^{xg(0)} \int_{-\infty}^{\infty} e^{xg(0) + \frac{x}{2}(g''(0) + \epsilon)s^2} ds = \sqrt{\frac{2\pi}{|g''(0) - \epsilon|}} (f(0) + \epsilon) e^{xg(0)} \end{aligned} \quad (3.28)$$

An inequality in the opposite direction follows in the same way, replacing \leq with \geq and ϵ with $-\epsilon$ in the first line of (3.28), and then noting that

$$\frac{\int_{-a}^a e^{-xs^2} ds}{\int_{-\infty}^{\infty} e^{-xs^2} ds} \rightarrow 1 \quad \text{as } x \rightarrow \infty \quad (3.29)$$

as can be seen by changing variables to $u = sx^{-\frac{1}{2}}$. \square

With appropriate decay conditions, the interval of integration does not have to be compact. For instance, let $J \subset \mathbb{R}$ be an interval (finite or not) and $[a, b] \subset J$.

Proposition 3.30 (*Interior maximum, noncompact interval*) Assume $f \in C[a, b] \cap L^\infty(J)$, $g \in C^2[a, b]$ has a unique absolute maximum at c and that $f(c) \neq 0$ and $g''(c) < 0$. Assume further that g is measurable in J and $g(c) - g(s) = \alpha + h(s)$ where $\alpha > 0$, $h(s) > 0$ on $J \setminus [a, b]$ and $e^{-h(s)} \in L^1(J)$. Then,

$$\int_J f(s) e^{xg(s)} ds = \sqrt{\frac{2\pi}{x|g''(c)|}} f(c) e^{xg(c)} (1 + o(1)) \quad (x \rightarrow +\infty) \quad (3.31)$$

PROOF This case reduces to the compact interval case by noting that

$$\begin{aligned} \left| \sqrt{x} e^{-xg(c)} \int_{J \setminus [a, b]} e^{xg(s)} f(s) ds \right| &\leq \sqrt{x} \|f\|_\infty e^{-x\alpha} \int_J e^{-xh(s)} ds \\ &\leq \text{Const.} \sqrt{x} e^{-x\alpha} \rightarrow 0 \quad \text{as } x \rightarrow \infty \end{aligned} \quad (3.32)$$

\square

Example. We see that the last proposition applies to the Gamma function by writing

$$n! = \int_0^\infty e^{-t} t^n dt = n^{n+1} \int_0^\infty e^{n(-s + \ln s)} ds \quad (3.33)$$

whence we get Stirling's formula

$$n! = \sqrt{2\pi n} \left(\frac{n}{e}\right)^n (1 + o(1)); \quad n \rightarrow +\infty$$

3.4 Watson’s lemma

In view of the wide applicability of BE summability—as we shall see later—solutions to many problems admit representations as Laplace transforms

$$(\mathcal{L}F)(x) := \int_0^\infty e^{-xp}F(p)dp \tag{3.34}$$

For the error function note that

$$\int_x^\infty e^{-s^2} ds = x \int_1^\infty e^{-x^2u^2} du = \frac{x}{2}e^{-x^2} \int_0^\infty \frac{e^{-x^2p}}{\sqrt{p+1}} dp$$

For the Gamma function, writing $\int_0^\infty = \int_0^1 + \int_1^\infty$ in (3.33) we can make the substitution $t - \ln t = p$ in each integral and obtain (see §3.9c for details) a representation of the form

$$n! = n^{n+1}e^{-n} \int_0^\infty e^{-np}G(p)dp$$

Watson’s lemma provides the asymptotic series at infinity of $(\mathcal{L}F)(x)$ in terms of the asymptotic series of $F(p)$ at zero.

Lemma 3.35 (Watson’s lemma) *Let $F \in L^1(\mathbb{R}^+)$ and assume $F(p) \sim \sum_{k=0}^\infty c_k p^{k\beta_1 + \beta_2 - 1}$ as $p \rightarrow 0^+$ for some constants β_i with $\text{Re}(\beta_i) > 0$, $i = 1, 2$. Then, for $a \leq \infty$,*

$$f(x) = \int_0^a e^{-xp}F(p)dp \sim \sum_{k=0}^\infty c_k \Gamma(k\beta_1 + \beta_2) x^{-k\beta_1 - \beta_2}$$

along any ray in \mathbb{H} .

Remark 3.36 The presence of $\Gamma(k\beta_1 + \beta_2)$ makes the x series often divergent even when F is analytic at zero. However, the asymptotic series of f is still the term-by-term Laplace transform of the series of F at zero, whether a is finite or not or the series converges or not. This freedom in choosing a shows that some information is lost.

PROOF We write $F = \sum_{k=0}^N c_k p^{k\beta_1 + \beta_2 - 1} + F_N(p)$. For the finite sum, we use the fact that

$$\int_0^a p^q e^{-xp} dp = \int_0^\infty p^q e^{-xp} dp + O(e^{-ax}) = \Gamma(q+1)x^{-q-1} + O(e^{-ax})$$

and estimate the remainder F_N using the following lemma. □

Lemma 3.37 Let $F \in L^1(\mathbb{R}^+)$, $x = \rho e^{i\phi}$, $\rho > 0$, $\phi \in (-\pi/2, \pi/2)$ and assume

$$F(p) \sim p^\beta \quad \text{as } p \rightarrow 0^+$$

with $\operatorname{Re}(\beta) > -1$. Then

$$\int_0^\infty F(p)e^{-px} dp \sim \Gamma(\beta + 1)x^{-\beta-1} \quad (\rho \rightarrow \infty)$$

PROOF If $U(p) = p^{-\beta}F(p)$ we have $\lim_{p \rightarrow 0} U(p) = 1$. Let χ_A be the characteristic function of the set A and $\phi = \arg(x)$. We choose C and a positive so that $|F(p)| \leq C|p^\beta|$ on $[0, a]$. Since

$$\left| \int_a^\infty F(p)e^{-px} dp \right| \leq e^{-a\operatorname{Re} x} \|F\|_1 \quad (3.38)$$

we have after the change of variable $s = p|x|$,

$$\begin{aligned} x^{\beta+1} \int_0^\infty F(p)e^{-px} dp &= e^{i\phi(\beta+1)} \int_0^\infty s^\beta U(s/|x|) \chi_{[0,a]}(s/|x|) e^{-se^{i\phi}} ds \\ &\quad + O(|x|^{\beta+1} e^{-xa}) \rightarrow \Gamma(\beta + 1) \quad (|x| \rightarrow \infty) \end{aligned} \quad (3.39)$$

by dominated convergence in the last integral. \square

3.4a The Borel-Ritt lemma

Any asymptotic series at infinity is the asymptotic series in a half-plane of some (vastly many in fact) entire functions. First a weaker result.

Proposition 3.40 Let $\tilde{f}(z) = \sum_{k=0}^\infty a_k z^k$ be a power series. There exists a function f so that $f(z) \sim \tilde{f}(z)$ as $z \rightarrow 0$.

PROOF The following elementary line of proof is reminiscent of optimal truncation of series. By Remark 1.32 we can assume, without loss of generality, that the series has zero radius of convergence. Let $z_0 > 0$ be small enough and for every z , $|z| < z_0$, define $N(z) = \max\{N : \forall n \leq N, |a_n z^{n/2}| \leq 2^{-n}\}$. We have $N(z) < \infty$, otherwise, by Abel's theorem, the series would have nonzero radius of convergence. Noting that for any n we have $n \ln |z| \rightarrow -\infty$ as $|z| \rightarrow 0$ it follows that $N(z)$ is nonincreasing as $|z|$ decreases and that $N(z) \rightarrow \infty$ as $z \rightarrow 0$. Consider

$$f(z) = \sum_{j=0}^{N(z)} a_j z^j$$

Let N be given and choose $z_N; |z_N| < 1$ such that $N(z_N) \geq N$. For $|z| < |z_N|$ we have $N(z) \geq N(z_N) \geq N$ and thus

$$\left| f(z) - \sum_{n=0}^N a_n z^n \right| = \left| \sum_{n=N+1}^{N(z)} a_n z^n \right| \leq \sum_{j=N+1}^{N(z)} |z^{j/2}| 2^{-j} \leq |z|^{N/2+1/2}$$

Using Lemma 1.13, the proof follows. □

The function f is certainly not unique. Given a power series there are many functions asymptotic to it. Indeed there are many functions asymptotic to the (identically) zero power series at zero, in any sectorial punctured neighborhood of zero in the complex plane, and even on the Riemann surface of the log on $\mathbb{C} \setminus \{0\}$, e.g., $e^{-x^{-1/n}}$ has this property in a sector of width $2n\pi$.

Lemma 3.41 (Borel-Ritt) *Given a formal power series $\tilde{f} = \sum_{k=0}^{\infty} \frac{c_k}{x^{k+1}}$ there exists an entire function $f(x)$, of exponential order of f is one (see proof below), which is asymptotic to \tilde{f} in \mathbb{H} , i.e., if $\phi \in (-\pi/2, \pi/2)$ then*

$$f(x) \sim \tilde{f} \text{ as } x = \rho e^{i\phi}, \quad \rho \rightarrow +\infty$$

PROOF Let $\tilde{F} = \sum_{k=0}^{\infty} \frac{c_k}{k!} p^k$, let $F(p)$ be a function asymptotic to \tilde{F} as in Proposition 3.40. Then clearly the function

$$f(x) = \int_0^1 e^{-xp} F(p) dp$$

is entire, bounded by $Const.e^{|x|}$, i.e., the exponential order is one, and, by Watson's lemma it has the desired properties. □

Exercises.

(1) How can this method be modified to give a function analytic in a sector of opening $2\pi n$ for an arbitrary fixed n which is asymptotic to \tilde{f} ?

(2) Assume F is bounded on $[0, 1]$ and has an asymptotic expansion $F(t) \sim \sum_{k=0}^{\infty} c_k t^k$ as $t \rightarrow 0^+$. Let $f(x) = \int_0^1 e^{-xp} F(p) dp$. (a) Find necessary and sufficient conditions on F such that \tilde{f} , the asymptotic power series of f for large positive x , is a convergent series for $|x| > R > 0$. (b) Assume that \tilde{f} converges to f . Show that f is zero. (c) Show that in case (a) if F is analytic in a neighborhood of $[0, 1]$ then $f = \tilde{f} + e^{-x} \tilde{f}_1$ where \tilde{f}_1 is convergent for $|x| > R > 0$.

(3) The width of the sector in Lemma 3.41 cannot be extended to more than a half-plane: Show that if f is entire, of exponential order one, and bounded in a

sector of opening exceeding π , then it is constant. (This follows immediately from the Phragmén-Lindelöf principle; an alternative proof can be derived from elementary properties of Fourier transforms and contour deformation.) The exponential order has to play a role in the proof: check that the function $\int_0^\infty e^{-px-p^2} dp$ is bounded for $\arg(x) \in (-\frac{3\pi}{4}, \frac{3\pi}{4})$. How wide can such a sector be made?

3.4b Laplace's method revisited: Reduction to Watson's lemma

(i) **Absolute maximum with nonvanishing derivative at left endpoint.**

Proposition 3.42 *Let g be analytic (smooth) on $[a, b]$ where $g' < -\alpha < 0$. Then the problem of finding the large x behavior of F in (3.15) is analytically (respectively smoothly) conjugated to the canonical problem of the large x behavior of*

$$\int_{g(a)}^{g(b)} e^{xs} H(s) ds = e^{xg(a)} \int_0^{g(a)-g(b)} e^{-xu} H(g(a) - u) du \quad (3.43)$$

with $H(s) = f(\varphi(s))\varphi'(s)$.

Conjugation just means that we can transform the original asymptotic problem to the similar one in the standard format (3.43), by analytic (smooth) changes of variable. Here the change is $g(s) = u$, $\varphi = g^{-1}$. The proof of smoothness is immediate, and we leave it to the reader. Note that we have not required $f(0) \neq 0$ anymore. If H is smooth and some derivative at zero is nonzero, Watson's lemma clearly provides the asymptotic expansion of the last integral in (3.43). The asymptotic series is dual, as in Lemma 3.35 to the series of H at $g(a)$.

(ii) **Absolute maximum with nonvanishing second derivative at an interior point.**

Proposition 3.44 *Let g be analytic (smooth) on the interval $a \leq 0 \leq b$, $a < b$, where $g'' < -\alpha < 0$ and assume $g(0) = 0$. Then the problem of finding the large x behavior of F in (3.15) is analytically (respectively smoothly) conjugated to the canonical problem of the large x behavior of*

$$\begin{aligned} & \int_{-\sqrt{|g(a)|}}^{\sqrt{|g(b)|}} e^{-xu^2} H(u) du \\ &= \frac{1}{2} \int_0^{|g(a)|} e^{-xv} H(-v^{\frac{1}{2}}) v^{-\frac{1}{2}} dv + \frac{1}{2} \int_0^{|g(b)|} e^{-xv} H(v^{\frac{1}{2}}) v^{-\frac{1}{2}} dv \quad (3.45) \end{aligned}$$

with $H(s) = f(\varphi(s))\varphi'(s)$, $\varphi^2(s) = -g(u)$. If $g, f \in C^k$, then $\varphi \in C^{k-1}$ and $H \in C^{k-2}$, and Watson's lemma applies to the last representation.

PROOF Note that near zero we have $g = -s^2h(s)$ where $h(0) = 1$. Thus \sqrt{h} is well defined and analytic (smooth) near zero; we choose the usual branch and note that the implicit function theorem applies to the equation $s\sqrt{h}(s) = u$ throughout $[a, b]$. The details are left to the reader. \square

Exercise 3.46 Assume $H \in C^\infty$ and $a > 0$. Show that the asymptotic behavior of

$$\int_{-a}^a e^{-xu^2} H(u) du \tag{3.47}$$

is given by the asymptotic series (usually divergent)

$$\sum_{l=0}^\infty \frac{1}{2l!} \int_{-\infty}^\infty H^{(2l)}(0) u^{2l} e^{-xu^2} du = \frac{1}{2} \sum_{l=0}^\infty \frac{\Gamma(l + \frac{1}{2})}{\Gamma(l + 1)} H^{(2l)}(0) x^{-\frac{1}{2}-l} \tag{3.48}$$

Note. In other words, the asymptotic series is obtained by formal expansion of H at the critical point $x = 0$ and termwise integration, extending the limits of integration to infinity. By symmetry, only derivatives of even order contribute. The value of “ a ” does not enter the formula, so once more, information is lost.

Exercise 3.49 Generalize (3.25) to the case when $g \in C^4[-1, 1]$ has a unique maximum, where g', g'', g''' vanish but $g^{(iv)}$ does not.

Exercise 3.50 * Consider the problem (3.19) with f and g smooth and take $a = 0$ for simplicity. Show that the asymptotic expansion of the integral equals the one obtained by the following formal procedure: we expand f and g in Taylor series at zero, replace f in the integral by its Taylor series, keep $xg'(0)$ in the exponent, reexpand $e^{xg''(0)s^2/2!+\dots}$ in series in s , and integrate the resulting series term by term. The contribution of a term cs^m is $c(g'(0))^{-m-1}m!/x^{-m-1}$.

Exercise 3.51 (*) Consider now the inner maximum problem in the form (3.25), with f and g smooth at zero. Formulate and prove a procedure similar to the one in the previous problem. Odd terms give zero contribution. An even power cs^{2m} gives rise to a contribution $c2^{m+\frac{1}{2}}\Gamma(m + \frac{1}{2})(g''(0))^{-m-\frac{1}{2}}x^{-m-\frac{1}{2}}$.

Exercise 3.52 (*) Use Exercise (3.50) to show that the Taylor coefficients of the inverse function ϕ^{-1} can be obtained from the Taylor coefficients of ϕ in the following way. Assume $\phi'(0) = 1$. We let $P_n(x)$, a polynomial in x , be the n -th asymptotic coefficient of $e^{y\phi(x/y)}$ as $y \rightarrow \infty$. The desired coefficient is $\frac{1}{n!} \int_0^\infty e^{-x} P_{n+1}(x) dx$.

Remark 3.53 There is a relatively explicit function inversion formula, first found by Lagrange, and generalized in a number of ways. It is often called the Lagrange-Bürmann inversion formula [37]. It applies to analytic functions f

with nonvanishing derivative at the relevant point, and it now can be shown by elementary complex analysis means:

$$f^{-1}(z) = f^{-1}(z_0) + \sum_{n=1}^{\infty} \frac{d^{n-1}}{dw^{n-1}} \left(\frac{w - f^{-1}(z_0)}{f(w) - z_0} \right)^n \Big|_{w=f^{-1}(z_0)} \frac{(z - z_0)^n}{n!} \quad (3.54)$$

3.5 Oscillatory integrals and the stationary phase method

In this setting, an integral of a function against a rapidly oscillating exponential becomes small as the frequency of oscillation increases. Again we first look at the case where there is minimal regularity; the following is a version of the Riemann-Lebesgue lemma.

Proposition 3.55 *Assume $f \in L^1[0, 2\pi]$. Then $\int_0^{2\pi} e^{ixt} f(t) dt \rightarrow 0$ as $x \rightarrow \pm\infty$. A similar statement holds in $L^1(\mathbb{R})$.*

It is enough to show the result on a set which is dense¹ in L^1 . Since trigonometric polynomials are dense in the continuous functions on a compact set², say in $C[0, 2\pi]$ in the sup norm, and thus in $L^1[0, 2\pi]$, it suffices to look at trigonometric polynomials, thus (by linearity), at e^{ikx} for fixed k ; for the latter we just calculate explicitly the integral; we have

$$\int_0^{2\pi} e^{ixs} e^{iks} ds = O(x^{-1}) \text{ for large } x. \quad \square$$

No rate of decay of the integral in Proposition 3.55 follows without further knowledge about the regularity of f . With some regularity we have the following characterization.

Proposition 3.56 *For $\eta \in (0, 1]$ let the $C^\eta[0, 1]$ be the Hölder continuous functions of order η on $[0, 1]$, i.e., the functions with the property that there is some constant $a > 0$ such that for all $x, x' \in [0, 1]$ we have $|f(x) - f(x')| \leq a|x - x'|^\eta$.*

(i) *We have*

$$f \in C^\eta[0, 1] \Rightarrow \left| \int_0^1 f(s) e^{ixs} ds \right| \leq \frac{1}{2} a \pi^\eta x^{-\eta} + O(x^{-1}) \text{ as } x \rightarrow \infty \quad (3.57)$$

¹A set of functions f_n which, collectively, are arbitrarily close to any function in L^1 . Using such a set we can write

$$\int_0^{2\pi} e^{ixt} f(t) dt = \int_0^{2\pi} e^{ixt} (f(t) - f_n(t)) dt + \int_0^{2\pi} e^{ixt} f_n(t) dt$$

and the last two integrals can be made arbitrarily small.

²One can associate the density of trigonometric polynomials with approximation of functions by Fourier series.

(ii) If $f \in L^1(\mathbb{R})$ and $|x|^\eta f(x) \in L^1(\mathbb{R})$ with $\eta \in (0, 1]$, then its Fourier transform $\hat{f} = \int_{-\infty}^{\infty} f(s)e^{-ixs} ds$ is in $C^\eta(\mathbb{R})$.

(iii) Let $f \in L^1(\mathbb{R})$. If $x^n f \in L^1(\mathbb{R})$ with $n - 1 \in \mathbb{N}$ then \hat{f} is $n - 1$ times differentiable, with the $n - 1$ th derivative Lipschitz continuous. If $e^{|Ax|} f \in L^1(\mathbb{R})$ then \hat{f} extends analytically in a strip of width $|A|$ centered on \mathbb{R} .

PROOF (i) We have as $x \rightarrow \infty$ ($\lfloor \cdot \rfloor$ denotes the integer part)

$$\begin{aligned} \left| \int_0^1 f(s)e^{ixs} ds \right| &= \left| \sum_{j=0}^{\lfloor \frac{x}{2\pi} - 1 \rfloor} \left(\int_{2j\pi x^{-1}}^{(2j+1)\pi x^{-1}} f(s)e^{ixs} ds + \int_{(2j+1)\pi x^{-1}}^{(2j+2)\pi x^{-1}} f(s)e^{ixs} ds \right) \right| + O(x^{-1}) \\ &= \left| \sum_{j=0}^{\lfloor \frac{x}{2\pi} - 1 \rfloor} \int_{2j\pi x^{-1}}^{(2j+1)\pi x^{-1}} (f(s) - f(s + \pi/x))e^{ixs} ds \right| + O(x^{-1}) \\ &\leq \sum_{j=0}^{\lfloor \frac{x}{2\pi} - 1 \rfloor} a \left(\frac{\pi}{x} \right)^\eta \frac{\pi}{x} \leq \frac{1}{2} a \pi^\eta x^{-\eta} + O(x^{-1}) \end{aligned} \tag{3.58}$$

(ii) We see that

$$\left| \frac{\hat{f}(s) - \hat{f}(s')}{(s - s')^\eta} \right| = \left| \int_{-\infty}^{\infty} \frac{e^{ixs} - e^{ixs'}}{x^\eta (s - s')^\eta} x^\eta f(x) dx \right| \leq \int_{-\infty}^{\infty} \left| \frac{e^{ixs} - e^{ixs'}}{(xs - xs')^\eta} \right| |x^\eta f(x)| dx \tag{3.59}$$

is bounded. Indeed, by elementary geometry we see that for $|\phi_1 - \phi_2| < \pi$ we have

$$|\exp(i\phi_1) - \exp(i\phi_2)| \leq |\phi_1 - \phi_2| \leq |\phi_1 - \phi_2|^\eta \tag{3.60}$$

while for $|\phi_1 - \phi_2| \geq \pi$ we see that

$$|\exp(i\phi_1) - \exp(i\phi_2)| \leq 2 \leq 2|\phi_1 - \phi_2|^\eta$$

(iii) Follows in the same way as (ii), using dominated convergence. □

Exercise 3.61 Complete the details of this proof. Show that for any $\eta \in (0, 1]$ and all $\phi_{1,2} \in \mathbb{R}$ we have $|\exp(i\phi_1) - \exp(i\phi_2)| \leq \sqrt{2}|\phi_1 - \phi_2|^\eta$.

Note. In Laplace type integrals Watson’s lemma implies that it suffices for a function to be continuous to ensure an $O(x^{-1})$ decay of the integral, whereas in Fourier-like integrals, the considerably weaker decay (3.57) is optimal as seen in the exercise below.

Exercise 3.62 (*) (a) Consider the function f given by the *lacunary trigonometric series* $f(z) = \sum_{k=2^n, n \in \mathbb{N}} k^{-\eta} e^{ikz}$, $\eta \in (0, 1)$. Show that $f \in C^\eta[0, 2\pi]$. One way is to write $\phi_{1,2}$ as $a_{1,2} 2^{-p}$, use the first inequality in (3.60) to estimate the terms in $f(\phi_1) - f(\phi_2)$ with $n < p$ and the simple bound $2/k^\eta$ for $n \geq p$. Then it is seen that $\int_0^{2\pi} e^{-ijs} f(s) ds = 2\pi j^{-\eta}$ (if $j = 2^m$ and zero otherwise) and the decay of the Fourier transform is exactly given by (3.57).

(b) Use Proposition 3.56 and the result in Exercise 3.62 to show that the function $f(t) = \sum_{k=2^n, n \in \mathbb{N}} k^{-\eta} t^k$, analytic in the open unit disk, has no analytic continuation across the unit circle, that is, the unit circle is a *barrier of singularities* for f .

Note 3.63 *Dense non-differentiability is essentially the only way one can get poor decay; see also Exercise 3.71.*

Note. In part (i), compactness of the interval is crucial. In fact, the Fourier transform of an $L^2(\mathbb{R})$ entire function may not necessarily decrease pointwise. Indeed, the function $\hat{f}(x) = 1$ on the interval $[n, n + e^{-n^2}]$ for $n \in \mathbb{N}$ and zero otherwise is in $L^1(\mathbb{R}) \cap L^2(\mathbb{R})$ and further has the property that $e^{|Ax|} \hat{f} \in L^1(\mathbb{R})$ for any $A \in \mathbb{R}$, and thus $\mathcal{F}^{-1} \hat{f}$ is entire. Thus \hat{f} is the Fourier transform of an entire function, it equals $\mathcal{F}^{-1} \hat{f}$ a.e., and nevertheless it does not decay pointwise as $x \rightarrow \infty$. Evidently the issue here is poor behavior of f at infinity, otherwise integration by parts would be possible, implying decay.

Proposition 3.64 *Assume $f \in C^n[a, b]$. Then we have*

$$\begin{aligned} \int_a^b e^{ixt} f(t) dt &= e^{ixa} \sum_{k=1}^n c_k x^{-k} + e^{ixb} \sum_{k=1}^n d_k x^{-k} + o(x^{-n}) \\ &= e^{ixt} \left(\frac{f(t)}{ix} - \frac{f'(t)}{(ix)^2} + \dots + (-1)^{n-1} \frac{f^{(n-1)}(t)}{(ix)^n} \right) \Big|_a^b + o(x^{-n}) \end{aligned} \quad (3.65)$$

PROOF This follows by integration by parts and the Riemann-Lebesgue lemma since

$$\begin{aligned} \int_a^b e^{ixt} f(t) dt &= e^{ixt} \left(\frac{f(t)}{ix} - \frac{f'(t)}{(ix)^2} + \dots + (-1)^{n-1} \frac{f^{(n-1)}(t)}{(ix)^n} \right) \Big|_a^b \\ &\quad + \frac{(-1)^n}{(ix)^n} \int_a^b f^{(n)}(t) e^{ixt} dt \end{aligned} \quad (3.66)$$

□

Corollary 3.67 (1) Assume $f \in C^\infty[0, 2\pi]$ is periodic with period 2π . Then $\int_0^{2\pi} f(t)e^{int} dt = o(n^{-m})$ for any $m > 0$ as $n \rightarrow +\infty, n \in \mathbb{Z}$.

(2) Assume $f \in C_0^\infty[a, b]$ vanishes at the endpoints together with all derivatives; then $\hat{f}(x) = \int_a^b f(t)e^{ixt} dt = o(x^{-m})$ for any $m > 0$ as $x \rightarrow +\infty$.

Exercise 3.68 Show that if f is analytic in a neighborhood of $[a, b]$ but not entire, then both series in (3.65) have zero radius of convergence.

Exercise 3.69 In Corollary 3.67 (2) show that $\limsup_{x \rightarrow \infty} e^{\epsilon|x|}|\hat{f}(x)| = \infty$ for any $\epsilon > 0$ unless $f = 0$.

Exercise 3.70 For smooth f , the interior of the interval does not contribute because of cancellations: rework the argument in the proof of Proposition 3.56 under smoothness assumptions. If we write $f(s + \pi/x) = f(s) + f'(s)(\pi/x) + \frac{1}{2}f''(c)(\pi/x)^2$ cancellation is manifest.

Exercise 3.71 Show that if f is piecewise differentiable and the derivative is in L^1 , then the Fourier transform is $O(x^{-1})$.

3.5.1 Oscillatory integrals with monotonic phase

Proposition 3.72 Let the real valued functions $f \in C^m[a, b]$ and $g \in C^{m+1}[a, b]$ and assume $g' \neq 0$ on $[a, b]$. Then

$$\int_a^b f(t)e^{ixg(t)} dt = e^{ixg(a)} \sum_{k=1}^m c_k x^{-k} + e^{ixg(b)} \sum_{k=1}^m d_k x^{-k} + o(x^{-m}) \quad (3.73)$$

as $x \rightarrow \pm\infty$, where the coefficients c_k and d_k can be computed by Taylor expanding f and g at the endpoints of the interval of integration.

This essentially follows from Proposition 3.42, since the problem is amenable by smooth transformations to the setting of Proposition 3.64. Carry out the details.

3.5a Stationary phase method

In general, the asymptotic behavior of oscillatory integrals of the form (3.73) comes from:

- Endpoints;
- Stationary points;
- Singularities of f or g .

We consider now the case when $g(s)$ has a stationary point (where $g' = 0$) inside the interval $[a, b]$. Then, the main contribution to the integral on the lhs of (3.73) comes from a neighborhood of the stationary point of g since around that point, for large x , the oscillations that make the integral small are by far the least rapid.

We have the following result:

Proposition 3.74 *Assume f, g are real valued $C^\infty[a, b]$ functions and that $g'(c) = 0$ and $g''(x) \neq 0$ on $[a, b]$. Then for any $1 \leq m \in \mathbb{N}$ we have*

$$\int_a^b f(s)e^{ixg(s)} ds = e^{ixg(c)} \sum_{k=1}^{2m} c_k x^{-k/2} + e^{ixg(a)} \sum_{k=1}^m d_k x^{-k} + e^{ixg(b)} \sum_{k=1}^m e_k x^{-k} + o(x^{-m}) \quad (3.75)$$

for large x , where the coefficients of the expansion can be calculated by Taylor expansion around a, b and c of the integrand as follows from the proof. In particular, we have

$$c_1 = \sqrt{\frac{2\pi i}{g''(c)}} f(c)$$

PROOF Again, by smooth changes of variables, the problem is amenable to the problem of the behavior of

$$J = \int_{-a}^a H(u)e^{ixu^2} du \quad (3.76)$$

which is given, as we will see in a moment, by

$$J \sim \sum_{k \geq 0} \left(e^{-ixa^2} \int_{-a}^{i\infty e^{i\pi/4}} \frac{H^{(k)}(-a)}{k!} (u+a)^k e^{ixu^2} du - e^{ixa^2} \int_a^{i\infty e^{i\pi/4}} \frac{H^{(k)}(a)}{k!} (u-a)^k e^{ixu^2} du + \int_{-\infty e^{-i\pi/4}}^{i\infty e^{i\pi/4}} \frac{H^{(2k)}(0)}{2k!} u^{2k} e^{ixu^2} du \right) \quad (3.77)$$

in the sense that J minus a finite number of terms of the series is small on the scale of the last term kept.

For a conveniently small ϵ we break the integral and are left with estimating the three integrals

$$J_1 = \int_{-a}^{-\epsilon} H(u)e^{ixu^2} du; \quad J_3 = \int_{\epsilon}^a H(u)e^{ixu^2} du; \quad J_2 = \int_{-\epsilon}^{\epsilon} H(u)e^{ixu^2} du$$

By smooth changes of variables, J_1 turns into

$$\int_{\epsilon^2}^{a^2} H_1(v)e^{ixv} dv \tag{3.78}$$

where H, H_1 are smooth. Proposition 3.64 applies to the integral (3.78); J_3 is treated similarly. For the second integral we write

$$\begin{aligned} J_2 - \sum_{l=0}^m \frac{H^{(k)}(0)}{k!} \int_{-\epsilon}^{\epsilon} u^k e^{ixu^2} du \\ = \int_{-\epsilon}^{\epsilon} u^{m+1} e^{ixu^2} F(u) du = \int_0^{\epsilon^2} v^{\frac{m-1}{2}} F_1(v) e^{ixv} du \end{aligned} \tag{3.79}$$

where F_1 is smooth. We can integrate by parts $m/2$ times in the last integral. Thus, combining the results from the two cases, we see that J has an asymptotic series in powers of $x^{-1/2}$. Since there exists an asymptotic series, we know it is unique. Then, the series of J cannot of course depend on an arbitrarily chosen parameter ϵ . Thus, we do not need to keep any endpoint terms at $\pm\epsilon$: they cancel out. \square

Note. It is easy to see that in the settings of Watson’s lemma and of Propositions 3.64, 3.72 and 3.74 the asymptotic expansions are differentiable, in the sense that the integral transforms are differentiable and their derivative is asymptotic to the formal derivative of the associated expansion.

3.5b Analytic integrands

In this case, contour deformation is used to transform oscillatory exponentials into decaying ones. A classical result in this direction is the following.

Proposition 3.80 (Fourier coefficients of analytic functions) *Assume f is periodic of period 2π , analytic in the strip $\{z : |\text{Im}(z)| < R\}$ and continuous in its closure. Then the Fourier coefficients $c_n = (2\pi)^{-1} \int_0^{2\pi} e^{int} f(t) dt$ are $o(e^{-|n|R})$ for large $|n|$. Conversely, if $c_n = o(e^{-|n|R})$, then f is analytic in the given strip.*

PROOF We take $n > 0$, the opposite case being very similar. By analyticity we have

$$\int_0^{2\pi} e^{int} f(t) dt = \int_0^{iR} e^{int} f(t) dt + \int_{iR}^{iR+2\pi} e^{int} f(t) dt - \int_{2\pi}^{2\pi+iR} e^{int} f(t) dt$$

The first and last terms on the right side cancel by periodicity while the middle one equals

$$e^{-nR} \int_0^{2\pi} e^{ins} f(s + iR) ds = o(e^{-nR}) \quad \text{as } n \rightarrow \infty$$

The converse is straightforward. □

3.5c Examples

Example 1. Consider the problem of finding the asymptotic behavior of the integral

$$I(n) = \int_{-\pi}^{\pi} \frac{e^{-int}}{2 - e^{it}} dt := \int_{-\pi}^{\pi} F(t) dt, \quad n \in \mathbb{N}$$

as $n \rightarrow \infty$. We see by [Corollary 3.67](#) that $J = o(x^{-m})$ for any $m \in \mathbb{N}$. Proposition 3.80 tells us more, namely that the integral is exponentially small. But both are just *upper bounds* for the decay, not precise estimates.

In this simple example, however, we could simply expand convergently the integrand and use dominated convergence:

$$\int_{-\pi}^{\pi} \frac{e^{-int}}{2 - e^{it}} = \int_{-\pi}^{\pi} \sum_{k=0}^{\infty} 2^{-k-1} e^{-it(n-k)} = \sum_{k=0}^{\infty} \int_{-\pi}^{\pi} 2^{-k-1} e^{-it(n-k)} = 2^{-n} \pi$$

In case $n < 0$ we get $I(n) = 0$. If we have $x \notin \mathbb{N}$ instead of n , we could try the same, but in this case we end up with

$$i(e^{-2\pi ix} - 1) \sum_{k=0}^{\infty} \frac{(-2)^{-k-1}}{x - k}$$

which needs further work to extract an asymptotic behavior in x .

We can alternatively apply a more general method to estimate the integral, using contour deformation. The point is to try to express J in terms of integrals along paths of constant phase of e^{-int} . This brings it, up to an overall multiplicative constant of modulus one, to Watson’s lemma setting. Note that F is analytic in $\mathbb{C} \setminus \{-i \ln 2 + 2k\pi\}_{k \in \mathbb{Z}}$ and meromorphic in \mathbb{C} . Furthermore, as $N \rightarrow \infty$ we have $F(t - iN) \rightarrow 0$ exponentially fast. This allows us to push the contour of integration down, in the following way. We have

$$\oint_C F(t) dt = 2\pi i \operatorname{Res}(F(t); t = -i \ln 2) = -\pi 2^{-x}$$

where the contour C of integration is an anticlockwise rectangle with vertices $\pi, -\pi, -iN - \pi, -iN + \pi$ with $N > \ln 2$. As $N \rightarrow \infty$ the integral over the segment from $-iN - \pi$ to $-iN + \pi$ goes to zero exponentially fast, and we find that

$$\int_{-\pi}^{\pi} F(t)dt = \int_{-\pi}^{-\pi-i\infty} F(t)dt - \int_{\pi}^{\pi-i\infty} F(t)dt + \pi 2^{-x}$$

$$I(x) = -i(e^{ix\pi} - e^{-ix\pi}) \int_0^{\infty} \frac{e^{-xs}}{2 + e^s} ds + \pi 2^{-x} = 2 \sin \pi x \int_0^{\infty} \frac{e^{-xs}}{2 + e^s} ds + \pi 2^{-x}$$

Watson’s lemma now applies and we have

$$\int_0^{\infty} \frac{e^{-xs}}{2 + e^s} ds \sim \frac{1}{3x} - \frac{1}{9x^2} - \frac{1}{27x^3} + \frac{1}{27x^4} + \frac{5}{81x^5} - \frac{7}{243x^6} + \dots$$

and thus

$$I(x) \sim 2 \sin \pi x \left(\frac{1}{3x} - \frac{1}{9x^2} - \frac{1}{27x^3} + \frac{1}{27x^4} + \frac{5}{81x^5} - \frac{7}{243x^6} + \dots \right) \quad (3.81)$$

whenever the prefactor in front of the series is not too small. More generally, the difference between $I(x)$ and the m -th truncate of the expansion is $o(x^{-m})$. Or, the function on the left side can be decomposed in two functions, using Euler’s formula for \sin , each of which has a nonvanishing asymptotic expansion. This is the way to interpret similar asymptotic expansions, which often occur in the theory of special functions, when the expansions involve oscillatory functions. But none of these characterizations tells us what happens when the prefactor is small. Does the function vanish when $\sin \pi x = 0$? Not for $x > 0$. Another reason to be careful with relations of the type (3.81).

Exercise 3.82 Make use of the results in this section to find the behavior as $y \rightarrow +\infty$ of

$$\sum_{k=0}^{\infty} \frac{a^k}{y + k}; \quad (|a| < 1)$$

3.5c.1 Note on exponentially small terms

In our case we have more information: if we add the term $\pi 2^{-x}$ to the expansion and write

$$I(x) \sim 2 \sin \pi x \left(\frac{1}{3x} - \frac{1}{9x^2} - \frac{1}{27x^3} + \frac{1}{27x^4} + \frac{5}{81x^5} - \frac{7}{243x^6} + \dots \right) + \pi 2^{-x} \quad (3.83)$$

then the expansion is valid when $x \rightarrow +\infty$ along the positive integers, a rather trivial case since only $\pi 2^{-x}$ survives. But we have trouble interpreting the expansion (3.83) when x is not an integer! The expression (3.83) is not of the form (1.7) nor can we extend the definition to allow for $\pi 2^{-x}$ since 2^{-x} is asymptotically smaller than any term of the series, and no number of limits as in Definition 1.11 would reveal it. We cannot subtract the whole series preceding the exponential from $I(x)$ to see “what is left,” since the series has

zero radius of convergence. (The k -th coefficient is, by Watson's lemma, $k!$ times the corresponding Maclaurin coefficient of the function $(2 + e^s)^{-1}$ and this function is not entire.)

We may nevertheless have the feeling that (3.83) is correct "somehow." Indeed it is, in the sense that (3.83) is the complete transseries of J , as it will become clear after we study more carefully BE summability.

*

3.6 Steepest descent method

Consider the problem of finding the large x behavior of an integral of the form

$$\int_C f(s)e^{xg(s)} ds \quad (3.84)$$

where g is analytic and f is meromorphic (more general singularities can be allowed) in a domain in the complex plane containing the contour C and x is a large parameter.

As in the Example 1 on p. 42, the key idea is to use deformation of contour to bring the integral to one which is suitable to the application of the Laplace method. We can assume without loss of generality that x is real and positive.

(A) Let $g = u + iv$ and let us first look at the simple case where C' is a curve such that $v = K$ is constant along it. Then

$$\int_{C'} f(s)e^{xg(s)} ds = e^{xiK} \int_{C'} f(s)e^{xu(s)} ds = e^{xiK} \int_0^1 f(\gamma(t))e^{xu(\gamma(t))} \gamma'(t) dt$$

is in a form suitable for Laplace's method.

The method of steepest descent consists in using the meromorphicity of f , analyticity of g to deform the contour of integration such that modulo residues, the original integral can be written as a sum of integrals of the type C' mentioned. The name steepest descent comes from the following remark. The lines of $v = \text{constant}$ are perpendicular to the direction of ∇v . As a consequence of the Cauchy-Riemann equations we have $\nabla u \cdot \nabla v = 0$ and thus the lines $v = \text{constant}$ are lines of steepest variation of u therefore of $|e^{xg(s)}|$. On the other hand, the best way to control the integral is to go along the descent direction. The direction of steepest descent of u is parallel to $-\nabla u$. Thus the steepest descent lines are the integral curves of the ODE system

$$\dot{x} = -u_x(x, y); \quad \dot{y} = -u_y(x, y) \quad (3.85)$$

We first look at some examples, and then discuss the method in more generality.

Example 1. The Bessel function $J_0(\xi)$ can be written as $\frac{1}{\pi}\text{Re } I$, where

$$I = \int_{-\pi/2}^{\pi/2} e^{i\xi \cos t} dt \tag{3.86}$$

Suppose we would like to find the behavior of $J_0(\xi)$ as $\xi \rightarrow +\infty$. It is convenient to find the steepest descent lines by plotting the phase portrait of the flow (3.85), which in our case is

$$\dot{x} = -\cos x \sinh y; \quad \dot{y} = -\sin x \cosh y \tag{3.87}$$

and which is easy to analyze by standard ODE means. Consequently, we write

$$I = \int_{-\pi/2}^{-\pi/2+i\infty} e^{i\xi \cos t} dt + \int_{\gamma} e^{i\xi \cos t} dt + \int_{\pi/2}^{\pi/2-i\infty} e^{i\xi \cos t} dt \tag{3.88}$$

as shown in Fig. 3.1.

All the curves involved in this decomposition of I are lines of constant imaginary part of the exponent, and the ordinary Laplace method can be applied to find their asymptotic behavior for $\xi \rightarrow +\infty$ (note also that the integral along the curve γ , called Sommerfeld contour, is the only one contributing to J_0 , the other two being purely imaginary, as it can be checked by making the changes of variable $t = -\pi/2 \pm is$). Then, the main contribution to the integral comes from the point along γ where the real part of the exponent is maximum, that is $z = 0$. We then expand $\cos t = 1 - t^2/2 + t^4/4! + \dots$ keep the first two terms in the exponent and expand the rest out:

$$\begin{aligned} \int_{\gamma} e^{i\xi \cos t} dt &\sim e^{ix} \int_{\gamma} e^{-i\xi t^2/2} (1 + i\xi t^4/4! + \dots) dt \\ &\sim \int_{\infty e^{3i\pi/4}}^{\infty e^{-i\pi/4}} e^{-i\xi t^2/2} (1 + i\xi t^4/4! + \dots) dt \end{aligned} \tag{3.89}$$

and integrate term by term. Justifying this rigorously would amount to redoing parts of the proofs of theorems we have already dealt with. Whenever possible, Watson’s lemma is a shortcut, often providing more information as well. We will use it for (3.86) in Example 4.

*

Example 2. We know by Watson’s lemma that for a function F which has a nontrivial power series at zero, $\mathcal{L}F = \int_0^\infty e^{-xp} F(p) dp$ decreases algebraically as $x \rightarrow \infty$. We also know by Proposition 2.22 that regardless of $F \neq 0 \in L^1$, $\mathcal{L}F$ cannot decrease superexponentially. What happens if F has a rapid oscillation near zero? Consider for $x \rightarrow +\infty$ the integral

$$I := \int_0^\infty e^{-xp} \cos(1/p) dp \tag{3.90}$$

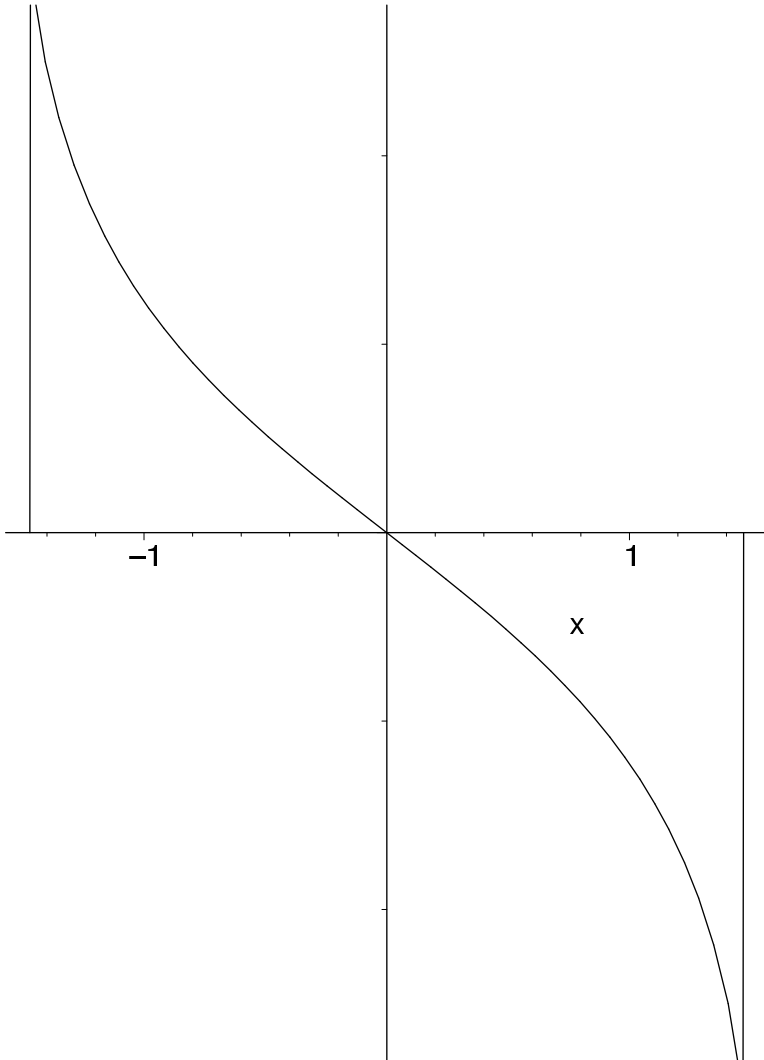

FIGURE 3.1: Relevant contours for J_0 ; γ is the curve through zero with vertical asymptotes at $\pm\pi/2$. See also [Fig. 3.3](#).

It is convenient to write

$$I = \operatorname{Re} \int_0^\infty e^{-xp} e^{-i/p} dp = \operatorname{Re} I_1 \quad (3.91)$$

To bring this problem to the steepest descent setting, we make the substitu-

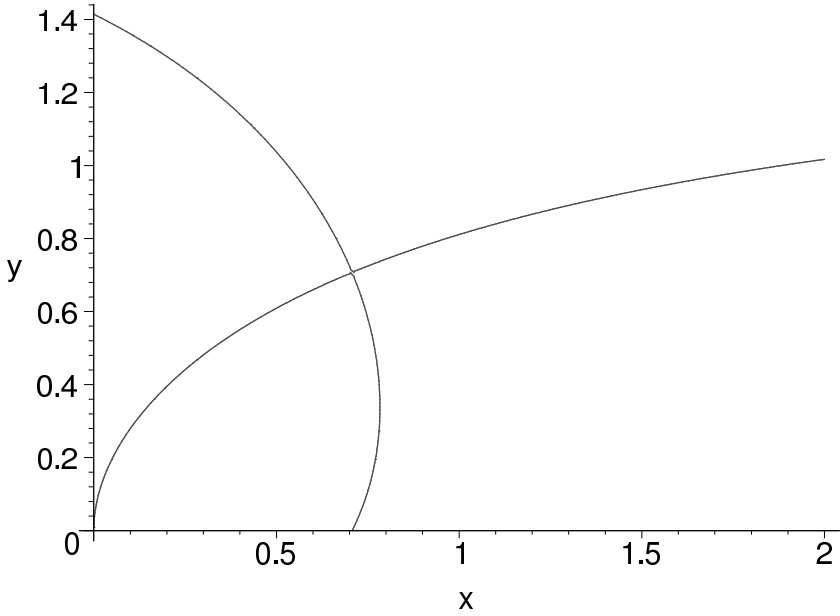

FIGURE 3.2: Constant phase lines for $t + i/t$ passing through the saddle point $t = \sqrt{i}$.

tion $p = t/\sqrt{x}$. Then I_1 becomes

$$I_1 = x^{-1/2} \int_0^\infty e^{-\sqrt{x}(t+i/t)} e^{-i/p} dp \tag{3.92}$$

The constant imaginary part lines of interest now are those of the function $t + i/t$. This function has saddle points where $(t + i/t)' = 0$, i.e., at $t = \pm\sqrt{i}$. We see that $t = \sqrt{i} = t_0$ is a maximum point for $-\text{Re } g := -\text{Re}(t + i/t)$ and the main contribution to the integral is from this point. We have, near $t = t_0$ $g = g(t_0) + \frac{1}{2}g''(t_0)(t - t_0)^2 + \dots$ and thus

$$I_1 \sim x^{-1/2} e^{-\sqrt{2}(1+i)\sqrt{x}} \int_{-\infty}^\infty \exp \left[\left(-\frac{1}{2} + \frac{i}{2} \right) \sqrt{2x}(t - t_0)^2 \right] \tag{3.93}$$

and the behavior of the integral is, roughly, $e^{-\sqrt{x}}$, decaying faster than powers of x but slower than exponentially. The calculation can be justified mimicking the reasoning in Proposition 3.24. But this integral too can be brought to a form suitable for Watson’s lemma.

For multidimensional extensions of the saddle point method see [28] and references therein .

Exercise 3.94 *Finish the calculations in this example.*

***3.6a Further discussion of steepest descent lines**

Assume for simplicity that g is nonconstant entire and f is meromorphic. We can let the points on the curve $C = (x_0(\tau), y_0(\tau)); \tau \in [0, 1]$ evolve with (3.85) keeping the endpoints fixed. More precisely, at time t consider the curve $t \mapsto C(t) = C_1 \cup C_2 \cup C_3$ where $C_1 = (x(s, x_0(0)), y(s, y_0(0))); s \in [0, t]$, $C_2 = (x(t, x_0(\tau)), y(t, y_0(\tau))), \tau \in (0, 1)$ and $C_3 = (x(s, x_0(1)), y(s, y_0(1))); s \in [0, t]$. Clearly, if no poles of f are crossed, then

$$\int_C f(s)e^{xg(s)} ds = \int_{C(t)} f(s)e^{xg(s)} ds \tag{3.95}$$

We can see that $z(t, x_0(\tau)) = (x(t, x_0(\tau)), y(t, x_0(\tau)))$ has a limit as $t \rightarrow \infty$ on the Riemann sphere, since u is strictly decreasing along the flow:

$$\frac{d}{dt} u(x(t), y(t)) = -u_x^2 - u_y^2 \tag{3.96}$$

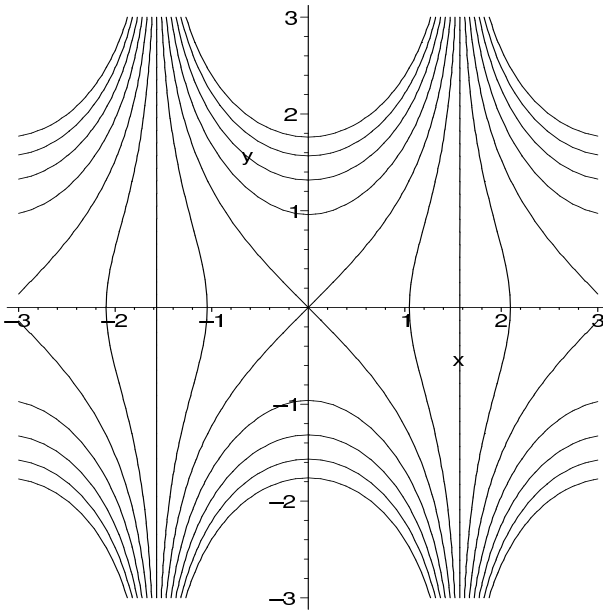

FIGURE 3.3: Steepest descent lines for $\text{Re}[i \cos(x + iy)]$.

There can be no closed curves along which $v = K = \text{const.}$ or otherwise we would have $v \equiv K$ since v is harmonic. Thus steepest descent lines extend to

infinity. They may pass through *saddle points* of u (and g : $\nabla u = 0 \Rightarrow g' = 0$) where their direction can change non-smoothly. These are equilibrium points of the flow (3.85).

Define \mathcal{S} as the smallest forward invariant set with respect to the evolution (3.85) which contains $(x_0(0), y_0(0))$, all the limits in \mathbb{C} of $z(t, x_0(\tau))$ and the descent lines originating at these points. The set \mathcal{S} is a union of steepest descent curves of u , $\mathcal{S} = \cup_{j=1}^n C_j$ and, if s_j are poles of f crossed by the curve $C(t)$ we have, under suitable convergence assumptions³,

$$\int_C f(s)e^{xg(s)} ds = \sum_{k=1}^{n' \leq n} \int_{C_k} f(s)e^{xg(s)} ds + 2\pi i \sum_j \text{Res}(f(s)e^{xg(s)})_{s=s_j} \quad (3.97)$$

and the situation described in (A) above has been achieved.

One can allow for branch points of f , each of which adds a contributions of the form

$$\int_C \delta f(s)e^{xg(s)} ds$$

where C is a cut starting at the branch point of f , along a line of steepest descent of g , and $\delta f(s)$ is the jump across the cut of f .

3.6b Reduction to Watson’s lemma

It is often more convenient to proceed as follows.

We may assume we are dealing with a simple smooth curve. We assume $g' \neq 0$ at the endpoints (the case of vanishing derivative is illustrated shortly on an example). Then, possibly after an appropriate small deformation of C , we have $g' \neq 0$ along the path of integration C and g is invertible in a small enough neighborhood \mathcal{D} of C . We make the change of variable $g(s) = -\tau$ and note that the image of C is smooth and has at most finitely many self-intersections. We can break this curve into piecewise smooth, simple curves. If the pieces are small enough, they are homotopic to (see [footnote](#) on p. 159) straight lines; we get

$$\sum_{n=1}^N \int_{c_n}^{c_{n+1}} f(s(\tau)) e^{-x\tau} \frac{ds}{d\tau} d\tau \quad (3.98)$$

³Convergence assumptions are required, as can be seen by applying the described procedure to very simple integral

$$\int_0^i e^{xe^{-z}} dz$$

We calculate each integral in the sum separately. Without loss of generality we take $n = 1$, $c_1 = 0$ and $c_2 = i$:

$$I_1 = \int_0^i f(s(\tau))e^{-x\tau} s'(\tau) d\tau \tag{3.99}$$

The lines of steepest descent for I_1 are horizontal, towards $+\infty$. Assuming suitable analyticity and growth conditions and letting $H(\tau) = f(s(\tau))s'(\tau)$ we get that I_1 equals

$$I_1 = \int_0^\infty e^{-x\tau} H(\tau) d\tau - \int_i^{i+\infty} H(\tau) e^{-x\tau} d\tau - 2\pi i \sum_j \text{Res}(H(\tau)e^{-x\tau})_{s=s_j} + \sum_j \int_{d_j}^{d_j+\infty} \delta H(\tau) e^{-x\tau} d\tau \tag{3.100}$$

where the residues come from poles of H in the strip $S = \{x + iy : x > 0, y \in [0, 1]\}$, if any, while d_j are branch points of H in S , if any, assumed integrable, and δH denotes the jump of H across the branch cut. If more convenient, one can alternatively subdivide C such that g' is nonzero on the (open) subintervals.

Example 4. In the integral (3.86) we have, using the substitution $\cos t = i\tau$,

$$\begin{aligned} \int_{-\pi/2}^{\pi/2} e^{i\xi \cos t} dt &= 2 \int_0^{\pi/2} e^{i\xi \cos t} dt = -2i \int_{-i}^0 \frac{e^{-\xi\tau}}{\sqrt{1+\tau^2}} d\tau = 2i \int_0^\infty \frac{e^{-\xi\tau}}{\sqrt{1+\tau^2}} d\tau \\ &- 2i \int_{-i}^{-i+\infty} \frac{e^{-\xi\tau}}{\sqrt{1+\tau^2}} d\tau = 2i \int_0^\infty \frac{e^{-\xi\tau}}{\sqrt{1+\tau^2}} d\tau - 2ie^{i\xi} \int_0^\infty \frac{e^{-\xi s}}{\sqrt{-2is+s^2}} ds \end{aligned} \tag{3.101}$$

to which Watson’s lemma applies.

Exercise. Find the asymptotic behavior for large x of

$$\int_{-1}^1 \frac{e^{ixs}}{s^2 + 1} ds$$

*

Example 5. The integral in (3.14) can be brought to Watson’s lemma setting by simple changes of variables. First we put $p = q\sqrt{x}$ and get

$$\text{Ai}(x) = \frac{1}{2\pi i} x^{1/2} \int_{\infty e^{-\pi i/3}}^{\infty e^{\pi i/3}} e^{-x^{3/2}(q-q^3/3)} dq \tag{3.102}$$

We see that $(q - q^3/3)' = 1 - q^2 = 0$ iff $q = \pm 1$. We now choose the contour of integration to pass through $q = 1$. It is natural to substitute $q = 1 + z$ and

then the integral becomes

$$\text{Ai}(x) = \frac{e^{-\frac{2}{3}x^{3/2}}x^{1/2}}{2\pi i} \left[\int_{\infty e^{-\pi i/3}}^0 e^{-x^{3/2}(z^2+z^3/3)} dz + \int_0^{\infty e^{\pi i/3}} e^{-x^{3/2}(z^2+z^3/3)} dz \right] \quad (3.103)$$

Along each path, the equation $z^2+z^3/3 = s$ has a unique, well-defined solution $z_{1,2}(s)$ where we choose $\arg(z_1) \rightarrow \pi/2$, as $s \rightarrow 0^+$. As $z_1 \rightarrow \infty e^{-i\pi/3}$ we have $s \rightarrow \infty$ tangent to \mathbb{R}^+ . We can homotopically deform the contour and write

$$\text{Ai}(x) = \frac{e^{-2/3x^{3/2}}x^{1/2}}{2\pi i} \left[\int_0^\infty e^{-sx^{3/2}} \frac{dz_1}{ds} ds - \int_0^\infty e^{-sx^{3/2}} \frac{dz_2}{ds} ds \right] \quad (3.104)$$

where the analysis proceeds as in the Gamma function case, inverting $z^2+z^3/2$ near zero and calculating the expansion to any number of orders.

Exercise 3.105 (*) Complete the details of the analysis and show that

$$\text{Ai}(x) = \frac{1}{2\sqrt{\pi}x^{1/4}} e^{-\frac{2}{3}x^{3/2}} (1 + o(1)) \quad (x \rightarrow +\infty) \quad (3.106)$$

§3.9b.

Again, once we know that an asymptotic series to a solution of an ODE exists, and it is differentiable (say by Watson’s lemma, or using the properties of the ODE), to obtain the first few terms of the asymptotic series it is easier to deal directly with the differential equation; see also [6], p. 101. We can proceed as follows. The asymptotic expansion of $\text{Ai}(x)$ is not a power series, but its logarithmic derivative is. We then substitute $y(x) = e^{w(x)}$ in the equation (a simple instance of the WKB method, discussed later; see also [6]), we get $(w')^2 + w'' = x$, and for a power series we expect $w'' \ll (w')^2$ (check that this would be true if w is a differentiable asymptotic power series; see also pp. 140 and 134), and set the iteration scheme

$$(w')_{n+1} = -\sqrt{x - (w'_n)'}; \quad w'_0 := 0$$

Then, $w'_1 = -\sqrt{x}$, and continuing the iteration we get

$$w'_n = -\sqrt{x} - \frac{1}{4x} + \frac{5}{32}x^{-5/2} - \frac{15}{64}x^{-4} + \frac{1105}{2048}x^{-11/2} - \dots$$

where the first n terms of the expansion do not change for $n > m$. It follows that

$$y \sim \text{Const.} e^{-\frac{2}{3}x^{3/2}} \left(1 - \frac{5}{48}x^{-3/2} + \frac{385}{4608}x^{-3} - \frac{85085}{663552}x^{-9/2} + \dots \right)$$

and the constant is obtained by comparing to (3.106).

The Bessel equation is

$$x^2 y'' + xy' + (x^2 - \nu^2)y = 0 \quad (3.107)$$

For $\nu = 0$

$$xy'' + y' + xy = 0 \quad (3.108)$$

to which Laplace's method applies. We get

$$(p^2 Y)' - pY + Y' = 0 \Rightarrow Y = C(p^2 + 1)^{-1/2} \quad (3.109)$$

We get solutions by taking contours from $+\infty$, around a singularity and back to infinity in

$$\int_C \frac{e^{-xp}}{\sqrt{p^2 + 1}} dp \quad (3.110)$$

or around both branch points.

Exercise 3.111 (*) Find the relations between these integrals (we know that there are exactly two linearly independent solutions to (3.108)).

To find the asymptotic behavior of an integral starting at $\infty + i - i\epsilon$, going around $x = i$ and then to $\infty + i + i\epsilon$, we note that this integral equals

$$\begin{aligned} 2 \int_i^{\infty+i} \frac{e^{-xp}}{\sqrt{p^2 + 1}} dp &= 2e^{-ix} \int_0^\infty \frac{e^{-xs}}{\sqrt{s^2 + 2is}} ds \\ &\sim e^{-ix} \sqrt{\pi} \left[\frac{1-i}{\sqrt{x}} + \frac{1}{8} \frac{1+i}{x^{3/2}} - \frac{9}{128} \frac{1-i}{x^{5/2}} + \dots \right] \end{aligned} \quad (3.112)$$

by Watson's lemma.

Exercise 3.113 (*) Using the binomial formula, find the general term in the expansion (3.112).

3.7 Application: Asymptotics of Taylor coefficients of analytic functions

There is dual relation between the behavior of the Taylor coefficients of an analytic function and the structure of its singularities in the complex plane. There exist very general results, with mild assumptions on the coefficients, and these are known as Tauberian/Abelian theorems [57].

We will study a few examples in which detailed information about the singularities is known, and then complete asymptotics of the coefficients can be found.

Proposition 3.114 Assume f is analytic in the open disk of radius $R + \epsilon$ with N cuts at $z_n = Re^{i\phi_n}$ towards infinity, and in a neighborhood of z_n the function f has a convergent Puiseux series⁴ (“convergent” can be replaced with “asymptotic”; see Note 3.116 below)

$$f(z) = (z - z_n)^{\beta_1^{[n]}} A_1^{[n]}(z) + \dots + (z - z_n)^{\beta_m^{[n]}} A_m^{[n]}(z) + A_{m+1}^{[n]}(z)$$

where $A_1^{[n]}, \dots, A_{m+1}^{[n]}$ are analytic in a neighborhood of $z = z_n$ (and we can assume $\beta_i^{[n]} \notin \mathbb{N}$). With $c_k = f^{(k)}(0)/k!$, we have

$$c_k \sim R^{-k} \sum_{l=1}^N e^{-ik\phi_l} \left(k^{-\beta_1^{[l]}-1} \sum_{j=0}^{\infty} \frac{C_{j;1}^{[l]}}{k^j} + \dots + k^{-\beta_m^{[l]}-1} \sum_{j=0}^{\infty} \frac{C_{j;m}^{[l]}}{k^j} \right) \quad (3.115)$$

where the coefficients $c_{j;m}^{[n]}$ can be calculated from the Taylor coefficients of the functions $A_1^{[n]}, \dots, A_m^{[n]}$, and conversely, this asymptotic expansion determines the functions $A_1^{[n]}, \dots, A_m^{[n]}$.

Note 3.116 We can relax the condition of convergence of the Puiseux series, replacing it with a condition of asymptoticity, where the $A_j^{[k]}$ become integer power series, with a slight modification of the proof: an arbitrary but finite numbers of terms of the asymptotic series are subtracted out and the contribution of the remainder is estimated straightforwardly.

PROOF We have

$$c_k = \frac{1}{2\pi i} \oint \frac{f(s)}{s^{k+1}} ds$$

where the contour is a small circle around the origin. This contour can be deformed, by assumption, to the dotted contour in the figure. The integral around the circle of radius $R + \epsilon$ can be estimated by

$$\frac{1}{2\pi} \left| \oint_{C_{R+\epsilon}} \frac{f(s)}{s^{k+1}} ds \right| \leq \|f\|_{\infty} (R + \epsilon)^{-k-1} = O((R + \epsilon)^{-k-1})$$

and does not participate in the series (3.115), since it is smaller than R^{-k} times any power of k , as $k \rightarrow \infty$. Now the contribution from each singularity is of the form

$$\frac{1}{2\pi} \int_{B_l} \frac{f(s)}{s^{k+1}} ds$$

⁴A convergent series in terms of integer or noninteger powers of the $z - z_n$.

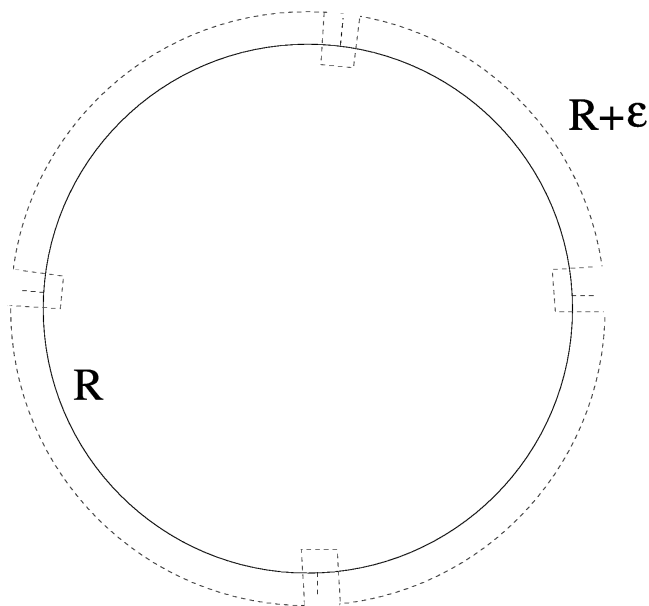

FIGURE 3.4: Deformation of the Cauchy contour.

where B_l is an open dotted box around the branch cut at $Re^{i\phi_l}$ as in the figure, so it is enough to know how to determine the contribution of one of them, say z_1 . By the substitution $f_1(z) = f(Re^{i\phi_1}z)$, we reduce ourselves to the case $R = 1$, $\phi = 0$. We omit for simplicity the superscript “[1].”

The integral along B_1 is a sum of integrals of the form

$$\frac{1}{2\pi i} \int_C (s-1)^\beta A(s) s^{-k-1} ds \quad (3.117)$$

We can restrict ourselves to the case when β is not an integer, the other case being calculable by residues.

Assume first that (i) $\text{Re}(\beta) > -1$. We then have

$$\frac{1}{2\pi i} \int_C (s-1)^\beta A(s) s^{-k-1} ds = -e^{\pi i \beta} \frac{\sin(\pi \beta)}{\pi} \int_1^{1+\epsilon} (s-1)^\beta A(s) s^{-k-1} ds \quad (3.118)$$

with the branch choice $\ln(s-1) > 0$ for $s \in (1, \infty)$. It is convenient to change variables to $s = e^u$. The right side of (3.118) becomes

$$-e^{\pi i \beta} \frac{\sin(\pi \beta)}{\pi} \int_0^{\ln(1+\epsilon)} u^\beta \left(\frac{e^u - 1}{u} \right)^\beta A(e^u) e^{-ku} du \quad (3.119)$$

where $A(e^u)$ and $[u^{-1}(e^u - 1)]^\beta$ are analytic at $u = 0$, the assumptions of Watson's lemma are satisfied and we thus have

$$\int_C (s - 1)^\beta A(s) s^{-k-1} ds \sim k^{-\beta-1} \sum_{j=0}^\infty \frac{d_j}{k^j} \tag{3.120}$$

where the d_j can be calculated straightforwardly from the Taylor coefficients of $A(e^u)[u^{-1}(e^u - 1)]^\beta$. The proof when $\text{Re } \beta \leq -1$ is by induction. Assume that (3.120) holds for all for $\text{Re } (\beta) > -m$ with $1 \leq m_0 \leq m$. One integration by parts gives

$$\begin{aligned} \int_C (s - 1)^\beta A(s) s^{-k-1} ds &= \frac{(s - 1)^{\beta+1}}{\beta + 1} A(s) s^{-k-1} \Big|_C \\ &\quad - \frac{1}{\beta + 1} \int_C (s - 1)^{\beta+1} [A(s) s^{-k-1}]' ds = O((R + \epsilon)^{-k-1}) \\ + k \frac{1 + 1/k}{\beta + 1} \int_C (s - 1)^{\beta+1} s A(s) s^{-k-1} ds &- \frac{1}{\beta + 1} \int_C (s - 1)^{\beta+1} A'(s) s^{-k-1} ds \end{aligned} \tag{3.121}$$

By assumption, (3.120) applies with $\beta + 1 \leftrightarrow \beta$ to both integrals in the last sum and the proof is easily completed. \square

Exercise 3.122 (*) Carry out the details of the argument sketched in Note 3.116.

3.7.1 Finding the location of singularities from the leading asymptotic expansion of Taylor coefficients

Exercise 3.123 Assume that the Maclaurin coefficients c_n of f at zero have the asymptotic behavior $c_n = an^{-2} + O(n^{-3})$. It is clear that f is singular on the unit circle. Show that one singularity is necessarily placed at $z = 1$. Hint: Consider the function $g(z) = f' - a \sum_{n=1}^\infty n^{-1} z^{n-1}$. Show that g is bounded at $z = 1$, while $\sum_{n=1}^\infty n^{-1} z^{n-1}$ is not.

3.8 Banach spaces and the contractive mapping principle

In rigorously proving asymptotic results about *solutions* of various problems, where a closed form solution does not exist or is awkward, the contractive mapping principle is a handy tool. Once an asymptotic expansion solution has

been found, if we use a truncated expansion as a quasi-solution, the remainder should be small. As a result, the complete problem becomes one to which the truncation is an exact solution modulo small errors (usually involving the unknown function). Therefore, most often, asymptoticity can be shown rigorously by rewriting this latter equation as a fixed point problem of an operator which is the identity plus a correction of tiny norm. Some general guidelines on how to construct this operator are discussed in §3.8b. It is desirable to go through the rigorous proof, whenever possible — this should be straightforward when the asymptotic solution has been correctly found—, one reason being that this quickly signals errors such as omitting important terms, or exiting the region of asymptoticity.

In §3.8.2 we discuss, for completeness, a few basic facts about Banach spaces. There is of course a vast literature on the subject; see e.g. [47].

3.8.2 A brief review of Banach spaces

Familiar examples of Banach spaces are the n -dimensional Euclidian vector spaces \mathbb{R}^n . A norm exists in a Banach space, which has the essential properties of a length: scaling, positivity except for the zero vector which has length zero and the triangle inequality (the sum of the lengths of the sides of a triangle is no less than the length of the third one). Once we have a norm, we can define limits, by reducing the notion to that in \mathbb{R} : $x_n \rightarrow x$ iff $\|x - x_n\| \rightarrow 0$. A normed vector space \mathcal{B} is a Banach space if it is complete, that is every sequence with the property $\|x_n - x_m\| \rightarrow 0$ uniformly in n, m (a Cauchy sequence) has a limit in \mathcal{B} . Note that \mathbb{R}^n can be thought of as the space of functions defined on the set of integers $\{1, 2, \dots, n\}$. If we take a space of functions on a domain containing infinitely many points, then the Banach space is usually infinite-dimensional. An example is $L^\infty[0, 1]$, the space of bounded functions on $[0, 1]$ with the norm $\|f\| = \sup_{[0,1]} |f|$. A function L between two Banach spaces which is linear, $L(x + y) = Lx + Ly$, is bounded (or continuous) if $\|L\| := \sup_{\|x\|=1} \|Lx\| < \infty$. Assume \mathcal{B} is a Banach space and that S is a closed subset of \mathcal{B} . In the *induced topology* (i.e., in the same norm), S is a complete normed space.

3.8.3 Fixed point theorem

Assume $\mathcal{M} : S \mapsto \mathcal{B}$ is a (linear or nonlinear) operator with the property that for any $x, y \in S$ we have

$$\|\mathcal{M}(y) - \mathcal{M}(x)\| \leq \lambda \|y - x\| \quad (3.124)$$

with $\lambda < 1$. Such operators are called **contractive**. Note that if \mathcal{M} is linear, this just means that the norm of \mathcal{M} is less than one.

Theorem 3.125 *Assume $\mathcal{M} : S \mapsto S$, where S is a closed subset of \mathcal{B} is a contractive mapping. Then the equation*

$$x = \mathcal{M}(x) \quad (3.126)$$

has a unique solution in S .

PROOF Consider the sequence $\{x_j\}_j \in \mathbb{N}$ defined recursively by

$$\begin{aligned} x_0 &= x_0 \in S & (3.127) \\ x_1 &= \mathcal{M}(x_0) \\ &\dots \\ x_{j+1} &= \mathcal{M}(x_j) \\ &\dots \end{aligned}$$

We see that

$$\|x_{j+2} - x_{j+1}\| = \|\mathcal{M}(x_{j+1}) - \mathcal{M}(x_j)\| \leq \lambda \|x_{j+1} - x_j\| \leq \dots \leq \lambda^j \|x_1 - x_0\| \tag{3.128}$$

Thus,

$$\|x_{j+p+2} - x_{j+2}\| \leq (\lambda^{j+p} + \dots + \lambda^j) \|x_1 - x_0\| \leq \frac{\lambda^j}{1 - \lambda} \|x_1 - x_0\| \tag{3.129}$$

and x_j is a Cauchy sequence, and it thus converges, say to x . Since by (3.124) \mathcal{M} is continuous, passing the equation for x_{j+1} in (3.127) to the limit $j \rightarrow \infty$ we get

$$x = \mathcal{M}(x) \tag{3.130}$$

that is existence of a solution of (3.126). For uniqueness, note that if x and x' are two solutions of (3.126), by subtracting their equations we get

$$\|x - x'\| = \|\mathcal{M}(x) - \mathcal{M}(x')\| \leq \lambda \|x - x'\| \tag{3.131}$$

implying $\|x - x'\| = 0$, since $\lambda < 1$. □

Note 3.132 Note that contractivity and therefore existence of a solution of a fixed point problem depends on the norm. An adapted norm needs to be chosen for this approach to give results.

Exercise 3.133 Show that if L is a linear operator from the Banach space \mathcal{B} into itself and $\|L\| < 1$ then $I - L$ is invertible, that is $x - Lx = y$ has always a unique solution $x \in \mathcal{B}$. “Conversely,” assuming that $I - L$ is not invertible, then in whatever norm $\|\cdot\|_*$ we choose to make the same \mathcal{B} a Banach space, we must have $\|L\|_* \geq 1$ (why?).

3.8a Fixed points and vector valued analytic functions

A theory of analytic functions with values in a Banach space can be constructed by almost exactly following the usual construction of analytic functions. For the construction to work, we need the usual vector space operations

and a topology in which these operations are continuous. A typical setting is that of a Banach algebra⁵. A detailed presentation is found in [30] and [39], but the basic facts are simple enough for the reader to redo the necessary proofs.

3.8b Choice of the contractive map

An equation can be rewritten in a number of equivalent ways. In solving an asymptotic problem, as a general guideline we mention:

- The operator \mathcal{N} appearing in the final form of the equation, which we want to be contractive, should not contain derivatives of highest order, small differences, or other operations poorly behaved with respect to asymptotics, and it should only depend on the sought-for solution in a formally small way. The latter condition should be, in a first stage, checked for consistency: the discarded terms, calculated using the first order approximation, should indeed turn out to be small.
- To obtain an equation where the discarded part is manifestly small it often helps to write the sought-for solution as the sum of the first few terms of the approximation, plus an exact remainder, say δ . The equation for δ is usually more contractive. It also becomes, up to smaller corrections, linear.
- The norms should reflect as well as possible the expected growth/decay tendency of the solution itself and the spaces chosen should be spaces where this solution lives.
- All freedom in the solution has been accounted for, that is, we should make sure the final equation cannot have more than one solution.

Note 3.134 At the stage where the problem has been brought to a contractive mapping setting, it usually can be recast without conceptual problems, but perhaps complicating the algebra, to a form where the implicit function theorem applies (and vice versa). The contraction mapping principle is often more natural, especially when the topology, suggested by the problem itself, is not one of the common ones. But an implicit function reformulation might bring in more global information. See [Remark 3.146](#).

⁵A Banach algebra is a Banach space of functions endowed with multiplication which is distributive, associative and continuous in the Banach norm.

3.9 Examples

3.9a Linear differential equations in Banach spaces

Consider the equation

$$Y'(t) = L(t)Y(t); \quad Y(0) = Y_0 \tag{3.135}$$

in a Banach space X , where $L(t) : X \rightarrow X$ is linear, norm continuous in t and uniformly bounded,

$$\sup_{t \in [0, \infty)} \|L(t)\| < L \tag{3.136}$$

Then the problem (3.135) has a global solution on $[0, \infty)$ and $\|Y\|(t) \leq C_\epsilon e^{(L+\epsilon)t}$.

PROOF By comparison with the case when $X = \mathbb{R}$, the natural growth is indeed Ce^{Lt} , so we rewrite (3.135) as an integral equation, in a space where the norm reflects this possible growth. Consider the space of continuous functions $Y : [0, \infty) \mapsto X$ in the norm

$$\|Y\|_{\infty, L} = \sup_{t \in [0, \infty)} e^{-Lt/\lambda} \|Y(t)\| \tag{3.137}$$

with $\lambda < 1$ and the auxiliary equation

$$Y(t) = Y_0 + \int_0^t L(s)Y(s)ds \tag{3.138}$$

which is well defined on X and is contractive there since

$$\begin{aligned} e^{-Lt/\lambda} \left| \int_0^t L(s)Y(s)ds \right| &\leq L e^{-Lt/\lambda} \int_0^t e^{Ls/\lambda} \|Y\|_{\infty, L} ds \\ &= \lambda(1 - e^{-Lt/\lambda}) \leq \lambda \|Y\|_{\infty, L} \end{aligned} \tag{3.139}$$

□

3.9b A Puiseux series for the asymptotics of the Gamma function

We choose a simple example which can be dealt with in a good number of other ways, yet containing some features of more complicated singular problems. Suppose we need to find the solutions of the equation $x - \ln x = t$ for t (and x) close to 1. The implicit function theorem does not apply to $F(x, t) = x - \ln x - t$ at $(1, 1)$ (it will however apply in a modified version of the problems, or rather in a pair of modified versions).

We attempt to find a simpler equation that approximates well the given one in the singular regime, that is we look for *asymptotic simplification*, and then we try to present the full problem as a perturbation of the approximate one. We write $x = 1 + z, t = 1 + s$, expand the left side in series for small z , and retain only the first nonzero term. The result is $z^2/2 \approx s$. There are two solutions, thus effectively two different problems when s is small. Keeping all terms, we treat the cubic and higher powers of z as corrections. We look at one choice of sign, the other one being very similar, and write

$$z = \left(2s + \frac{2z^3}{3} - \frac{z^4}{2} + \frac{2z^5}{5} + \dots \right)^{1/2} = (2s + \epsilon(z))^{1/2} \quad (3.140)$$

where $\epsilon(z)$ is expected to be small. We then have

$$z = (2s + O(z^3))^{1/2} = (2s + O(s^{3/2}))^{1/2} \quad (3.141)$$

hence

$$z = \left(2s + \left[(2s)^{1/2} + O(s^{3/2}) \right]^3 / 3 \right)^{1/2} = \left(2s + \frac{4\sqrt{2}}{3} s^{3/2} + O(s^2) \right)^{1/2} \quad (3.142)$$

and further,

$$z = \left(2s + \frac{4\sqrt{2}}{3} s^{3/2} + \frac{2s^2}{3} + O(s^{5/2}) \right)^{1/2} = \sqrt{2s} + \frac{2s}{3} + \frac{\sqrt{2}}{18} s^{3/2} - \frac{2s^2}{135} + O(s^{5/2}) \quad (3.143)$$

etc., where in fact the emerging series converges, as shown in the Exercise 3.145 below. Here z should be close to $\sqrt{2s}$; we set $s = w^2/2$ and $z = wZ$ and get

$$Z = \left(1 + \frac{2}{3} wZ^3 - \frac{1}{2} w^2 Z^4 + \frac{2}{5} w^3 Z^5 + \dots \right)^{1/2} \quad (3.144)$$

Exercise 3.145 Show that if ϵ is small enough, then (3.144) is contractive in the sup norm in a ball of radius ϵ centered at 1 in the space of functions Z analytic in w for $|w| \leq \epsilon$. Show thus that z is analytic in \sqrt{s} for small s .

Remark 3.146 (Implicit function theorem formulation) Once we know the adequate contractive map setting, the implicit function theorem can provide more global information. We take $t = \tau^2/2$ and write $z^2/2 + (z - \ln(1 + z) - z^2/2) =: z^2/2(1 + z\phi(z)) = \tau^2/2$ and (differentiating $z\phi$, reintegrating and changing variables) we get

$$z\sqrt{1 - z\phi(z)} = \pm\tau; \quad \phi(z) = \int_0^1 \frac{\sigma^2 d\sigma}{1 + z\sigma} \quad (3.147)$$

with the usual choice of branch for the square root. *The implicit function theorem clearly applies, at (0, 0), to the functions $F(z, w) := z\sqrt{1 - z\phi(z)} \pm w$.* We can now determine, for instance, the radius of convergence of the series. The first few terms of the series are easily found from the fixed point equation by repeated iteration, as in §3.9g,

$$z = \frac{1}{\sqrt{2}}\tau + \frac{1}{12}\tau^2 - \frac{\sqrt{2}}{72}\tau^3 + \frac{13}{4320}\tau^4 + \dots \tag{3.148}$$

3.9c The Gamma function

We start from the representation

$$n! = \int_0^\infty t^n e^{-t} dt = n^{n+1} \int_0^\infty e^{-n(s-\ln s)} ds \tag{3.149}$$

We can now use the results in §3.9b and Watson’s lemma to find the behavior of $n!$. With $s = 1 + z, z - \ln(1 + z) = u^2, dz = F(u)du$ we have

$$F(u) = \sqrt{2} + \frac{4}{3}u + \frac{\sqrt{2}}{6}u^2 - \frac{8}{135}u^3 + \frac{\sqrt{2}}{216}u^4 + \frac{8}{2835}u^5 - \dots \tag{3.150}$$

Exercise 3.151 (*) *Note the pattern of signs: + + - - Show that this pattern continues indefinitely.*

We have, using Exercise 3.46,

$$\int_0^\infty e^{-n(s-\ln s)} ds \sim n^n e^{-n} \sqrt{2} \int_{-\infty}^\infty \left(1 + \frac{u^2}{6} + \dots\right) e^{-nu^2} du \tag{3.152}$$

or

$$n! \sim \sqrt{2\pi n} n^n e^{-n} \left(1 + \frac{1}{12n} + \frac{1}{288n^2} - \frac{139}{51840n^3} + \dots\right) \tag{3.153}$$

3.9d Linear meromorphic differential equations. Regular and irregular singularities

A linear meromorphic m -th order differential equation has the canonical form

$$y^{(m)} + B_{m-1}(x)y^{(m-1)} + \dots + B_0(x)y = B(x) \tag{3.154}$$

where the coefficients $B_j(x)$ are meromorphic near x_0 . We note first that any equation of the form (3.154) can be brought to a homogeneous meromorphic of order $n = m + 1$

$$y^{(n)} + C_{n-1}(x)y^{(n-1)} + \dots + C_0(x)y = 0 \tag{3.155}$$

by dividing (3.154) by $B(x)$ and differentiating once. We want to look at the possible singularities of the solutions $y(x)$ of this equation. Note first that

by the general theory of linear differential equations (or by a simple fixed point argument) if all coefficients are analytic at a point x_0 , then the general solution is also analytic. Such a point is called regular point. Solutions of linear ODEs can only be singular where coefficients are singular; these are called singularities of the equation.

A singular point of the equation may be regular or irregular. The distinction can be made based on the features of the complete set of local solutions, whether they can be expressed as convergent asymptotic power-logarithmic series (regular singularity) or not (irregular one). See [16] for a detailed study.

Theorem 3.156 (Frobenius) *If near the point $x = x_0$ the coefficients C_{n-j} , $j = 1, \dots, n$ can be written as $(x - x_0)^{-j} A_{n-j}(x)$ where A_{n-j} are analytic, then there is a fundamental system of solutions in the form of convergent Frobenius series:*

$$y_m(x) = (x - x_0)^{r_m} \sum_{j=0}^{N_m} (\ln(x - x_0))^j B_{j;m}(x) \quad (3.157)$$

where $B_{j;m}$ are analytic in an open disk centered at x_0 with radius equal to the distance from x_0 to the first singularity of A_j . The powers r_m are solutions of the indicial equation

$r(r - 1) \cdots (r - n + 1) + A_{n-1}(x_0)r(r - 1) \cdots (r - n + 2) + \dots + A_0(x_0) = 0$
 Furthermore, logs appear only in the resonant case, when two (or more) characteristic roots r_m differ by an integer.

A straightforward way to prove the theorem is by induction on n . We can take $x_0 = 0$.

Let r_M be one of the roots of the indicial equation, so that $r_M + n$ is not a root for any $n \in \mathbb{N}$. A transformation of the type $y = x^{r_M} f$ reduces the equation (3.155) to an equation of the same type, but where one indicial root is zero. One can show that there is an analytic solution f_0 of this equation by inserting a power series, identifying the coefficients and estimating the growth of the coefficients. The substitution $f = f_0 \int g(s) ds$ gives an equation for g which is of the same type as (3.155) but of order $n - 1$. This completes the induction step. For $n = 1$, the result is trivial.

We will not go into the details of the general case but instead we illustrate the approach on the simple equation

$$x(x - 1)y'' + y = 0 \quad (3.158)$$

around $x = 0$. The indicial equation is $r(r - 1) = 0$ (a resonant case: the roots differ by an integer). Substituting $y_0 = \sum_{k=0}^{\infty} c_k x^k$ in the equation and identifying the powers of x yields the recurrence

$$c_{k+1} = \frac{k^2 - k + 1}{k(k + 1)} c_k \quad (3.159)$$

with $c_0 = 0$ and c_1 arbitrary. By linearity we may take $c_1 = 1$ and by induction we see that $0 < c_k < 1$. Thus the power series has radius of convergence at least 1. The radius of convergence is in fact exactly one as it can be seen applying the ratio test and using (3.159); the series converges exactly up to the nearest singularity of (3.158).

Exercise 3.160 *What is the asymptotic behavior of c_k as $k \rightarrow \infty$?*

We let $y_0 = y_0 \int g(s)ds$ and get, after some calculations, the equation

$$g' + 2\frac{y_0'}{y_0}g = 0 \tag{3.161}$$

and, by the previous discussion, $2y_0'/y_0 = 2/x + A(x)$ with $A(x)$ analytic. The point $x = 0$ is a regular singular point of (3.161) and in fact we can check that $g(x) = C_1x^{-2}B(x)$ with C_1 an arbitrary constant and $B(x)$ analytic at $x = 0$. Thus $\int g(s)ds = C_1(a/x + b\ln(x) + A_1(x)) + C_2$ where $A_1(x)$ is analytic at $x = 0$. Undoing the substitutions we see that we have a fundamental set of solutions in the form $\{y_0(x), B_1(x) + B_2(x) \ln x\}$ where B_1 and B_2 are analytic.

A converse of this theorem also holds, namely

Theorem 3.162 (Fuchs) *If a meromorphic linear differential equation has, at $x = x_0$, a fundamental system of solutions in the form (3.157), then x_0 is a regular singular point of the equation.*

For *irregular* singularities, at least one formal solution contains divergent power series and/or exponentially small (large) terms. The way divergent power series are generated by the higher order of the poles is illustrated below.

Example. Consider the equation

$$y' + z^{-2}y = 1 \tag{3.163}$$

which has an irregular singularity at $z = 0$ since the order of the pole in $C_0 = z^{-2}$ exceeds the order of the equation. Substituting $y = \sum_{k=0}^{\infty} c_k z^k$ we get $c_0 = c_1 = 0, c_2 = 1$ and in general the recurrence

$$c_{k+1} = -kc_k$$

whence $c_k = (-1)^k(k-1)!$ and the series has zero radius of convergence. (It is useful to compare this recurrence with the one obtained if z^{-2} is replaced by z^{-1} or by 1.) The associated homogeneous equation $y' + z^{-2}y = 0$ has the general solution $y = Ce^{1/z}$ with an exponential singularity at $z = 0$.

3.9e Spontaneous singularities: The Painlevé's equation P_1

In nonlinear differential equations, the solutions may be singular at points x where the equation is regular. For example, the equation

$$y' = y^2 + 1$$

has a one parameter family of solutions $y(x) = \tan(x + C)$; each solution has infinitely many poles. Since the location of these poles depends on C , thus on the solution itself, these singularities are called *movable* or *spontaneous*.

Let us analyze local singularities of the Painlevé equation P_1 ,

$$y'' = y^2 + x \tag{3.164}$$

We look at the local behavior of a solution that blows up, and will find solutions that are meromorphic but not analytic. In a neighborhood of a point where y is large, keeping only the largest terms in the equation (*dominant balance*) we get $y'' = y^2$ which can be integrated explicitly in terms of elliptic functions and its solutions have double poles. Alternatively, we may search for a power-like behavior

$$y \sim A(x - x_0)^p$$

where $p < 0$ obtaining, to leading order, the equation $Ap(p - 1)x^{p-2} = A^2p^2$ which gives $p = -2$ and $A = 6$ (the solution $A = 0$ is inconsistent with our assumption). Let's look for a power series solution, starting with $6(x - x_0)^{-2}$: $y = 6(x - x_0)^{-2} + c_{-1}(x - x_0)^{-1} + c_0 + \dots$. We get: $c_{-1} = 0, c_0 = 0, c_1 = 0, c_2 = -x_0/10, c_3 = -1/6$ and c_4 is undetermined, thus free. Choosing a c_4 , all others are uniquely determined. To show that there indeed is a convergent such power series solution, we follow the remarks in §3.8b. Substituting $y(x) = 6(x - x_0)^{-2} + \delta(x)$ where for consistency we should have $\delta(x) = o((x - x_0)^{-2})$ and taking $x = x_0 + z$ we get the equation

$$\delta'' = \frac{12}{z^2}\delta + z + x_0 + \delta^2 \tag{3.165}$$

Note now that our assumption $\delta = o(z^{-2})$ makes $\delta^2/(\delta/z^2) = z^2\delta = o(1)$ and thus the nonlinear term in (3.165) is *relatively* small. Thus, *to leading order*, the new equation is linear. This is a general phenomenon: taking out more and more terms out of the local expansion, the correction becomes less and less important, and the equation is better and better approximately by a linear equation. It is then natural to separate out the large terms from the small terms and write a fixed point equation for the solution based on this separation. We write (3.165) in the form

$$\delta'' - \frac{12}{z^2}\delta = z + x_0 + \delta^2 \tag{3.166}$$

and integrate as if the right side was known. This leads to an equivalent integral equation. Since all unknown terms on the right side are chosen to

be *relatively smaller*, by construction this integral equation is expected to be contractive. The indicial equation for the Euler equation corresponding to the left side of (3.166) is $r^2 - r - 12 = 0$ with solutions 4, -3. By the method of variation of parameters we thus get

$$\begin{aligned} \delta &= \frac{D}{z^3} - \frac{1}{10}x_0z^2 - \frac{1}{6}z^3 + Cz^4 - \frac{1}{7z^3} \int_0^z s^4\delta^2(s)ds + \frac{z^4}{7} \int_0^z s^{-3}\delta^2(s)ds \\ &= -\frac{1}{10}x_0z^2 - \frac{1}{6}z^3 + Cz^4 + J(\delta) \end{aligned} \quad (3.167)$$

the assumption that $\delta = o(z^{-2})$ forces $D = 0$; C is arbitrary. To find δ formally, we would simply iterate (3.167) in the following way: We take $r := \delta^2 = 0$ first and obtain $\delta_0 = -\frac{1}{10}x_0z^2 - \frac{1}{6}z^3 + Cz^4$. Then we take $r = \delta_0^2$ and compute δ_1 from (3.167) and so on. This yields:

$$\delta = -\frac{1}{10}x_0z^2 - \frac{1}{6}z^3 + Cz^4 + \frac{x_0^2}{1800}z^6 + \frac{x_0}{900}z^7 + \dots \quad (3.168)$$

This series is actually convergent. To see that, we scale out the leading power of z in δ , z^2 and write $\delta = z^2u$. The equation for u is

$$\begin{aligned} u &= -\frac{x_0}{10} - \frac{z}{6} + Cz^2 - \frac{z^{-5}}{7} \int_0^z s^8u^2(s)ds + \frac{z^2}{7} \int_0^z su^2(s)ds \\ &= -\frac{x_0}{10} - \frac{z}{6} + Cz^2 + J(u) \end{aligned} \quad (3.169)$$

It is straightforward to check that, given C_1 large enough (compared to $x_0/10$ etc.) there is an ϵ such that this is a contractive equation for u in the ball $\|u\|_\infty < C_1$ in the space of analytic functions in the disk $|z| < \epsilon$. We conclude that δ is analytic and that y is meromorphic near $x = x_0$.

Note. The Painlevé property discussed in §3.9f, requires that y is globally meromorphic, and we did *not* prove this. That indeed y is globally meromorphic is in fact true, but the proof is delicate (see e.g. [1]). Generic equations fail even the local Painlevé property. For instance, for the simpler, autonomous, equation

$$f'' + f' + f^2 = 0 \quad (3.170)$$

the same analysis yields a local behavior starting with a double pole, $f \sim -6z^{-2}$. Taking $f = -6z^{-2} + \delta(z)$ with $\delta = o(z^{-2})$ again leads to a nearly linear equation for δ which can be solved by convergent iteration, using arguments similar to the ones above. The iteration is (for some $a \neq 0$)

$$\delta = \frac{6}{5z} + Cz^4 - \frac{1}{7z^3} \int_0^z s^4\delta^2(s)ds + \frac{z^4}{7} \int_a^z s^{-3}\delta^2(s)ds \quad (3.171)$$

but now the leading behavior of δ is larger, $\frac{6}{5z}$. Iterating in the same way as before, we see that this will eventually produce logs in the expansion for δ (it

first appears in the second integral, thus in the form $z^4 \ln z$). We get

$$\delta = \frac{6}{5z} + \frac{1}{50} + \frac{z}{250} + \frac{7z^2}{5000} + \frac{79}{75000}z^3 - \frac{117}{2187500}z^4 \ln(z) + Cz^4 + \dots \quad (3.172)$$

where later terms will contain higher and higher powers of $\ln(z)$. This is effectively a series in powers of z and $\ln z$ a simple example of a transseries, which is convergent as can be straightforwardly shown using the contractive mapping method, as above.

Note 3.173 *Eq. (3.170) does not have the Painlevé property; see § 3.9f below. This log term shows that infinitely many solutions can be obtained just by analytic continuation around one point, and suggests the equation is not integrable.*

*3.9f Discussion: The Painlevé property

Painlevé studied the problem of finding differential equations, now called equations with the Painlevé property, whose only *movable* singularities are poles⁶. There are no restriction on the behavior at singular points of *the equation*. The solutions of such an equation have a common Riemann surface simple enough we can hope to understand globally. The motivation of this study apparently goes back to Fuchs, who had the intuition that through such equations one should be able to construct interesting, well-behaved new functions.

We note that the Painlevé property guarantees some form of integrability of the equation, in the following sense. If we denote by $Y(x; x_0; C_1, C_2)$ the solution of the differential equation $y'' = F(x, y, y')$ with initial conditions $y(x_0) = C_1, y'(x_0) = C_2$ we see that $y(x_1) = Y(x_1; x; y(x), y'(x))$ is constant along trajectories and so is $y'(x_1) = Y'(x_1; x; y(x), y'(x))$. This gives thus two constants of motion in \mathbb{C} provided the solution Y is well defined almost everywhere in \mathbb{C} , i.e., if Y is meromorphic.

On the contrary, “randomly occurring” movable branch-points make the inversion process explained above ill defined. Failure of the method does not of course entail absence of constants of motion. But the presence of spontaneous branch-points does have the potential to prevent the existence of well-behaved constants of motions for the following reason. Suppose y_0 satisfies a meromorphic (second order, for concreteness) ODE and $K(x; y, y')$ is a constant of motion. If x_0 is a branch point for y_0 , then y_0 can be continued past x_0 by avoiding the singular point, or by going around x_0 any number of times before

⁶There is no complete agreement on what the Painlevé property should require and Painlevé himself apparently oscillated among various interpretations; certainly movable branch points are not allowed, but often the property is understood to mean that all solutions are single-valued on a common Riemann surface.

moving away. This leads to different branches $(y_0)_n$ of y_0 , all of them, by simple analytic continuation arguments, solutions of the same ODE. By the definition of $K(x; y, y')$ however, we should have $K(x; (y_0)_n, (y_0)'_n) = K(x; y_0, y'_0)$ for all n , so K assumes the same value on this infinite set of solutions. We can proceed in the same way around other branch points x_1, x_2, \dots possibly returning to x_0 from time to time. Generically, we expect to generate a family of $(y_0)_{n_1, \dots, n_j}, (y_0)'_{n_1, \dots, n_j}$ which is dense in the phase space. This is an expectation, to be proven in specific cases. To see whether an equation falls in this generic class M. Kruskal introduced a test of nonintegrability, the *poly-Painlevé test* which measures indeed whether branching is “dense.” Properly interpreted and justified the Painlevé property measures whether an equation is integrable or not. See, e.g., [15].

3.9g Irregular singularity of a nonlinear differential equation

As another example, consider the equation

$$y' + y = x^{-1} + y^3 + xy^5 \tag{3.174}$$

with the restriction $y \rightarrow 0$ as $x \rightarrow +\infty$. Exact solutions exist for special classes of equations, and (3.174) does not (at least not manifestly) belong to any of them. However, formal asymptotic series solutions, as $x \rightarrow \infty$, are usually easy to find. If y is small and power-like, then $y', y^3 \ll y$ and, proceeding as in §1.2, a first approximation is $y_1 \approx 1/x$. Then $y_2 \approx 1/x + y_1^3 + xy_1^5 - y_1'$. A few iterations quickly yield (see Appendix 3.9i)

$$y(x) = x^{-1} + x^{-2} + 3x^{-3} + 13x^{-4} + 69x^{-5} + 428x^{-6} + O(x^{-7}) \tag{3.175}$$

To find a contractive mapping reformulation, we have to find what can be dropped in a first approximation. Though the derivative is formally small, as we discussed in §3.8b, it cannot be discarded when a rigorous proof is sought. Since f and $1/x$ are both formally larger than f' , they cannot be discarded either. Thus the approximate equation can only be

$$y' + y = x^{-1} + E(f) \tag{3.176}$$

where the “error term” E is just $f^3 + xf^5$. An equivalent integral equation is obtained by solving (3.176) as though E was known,

$$y = g_0 + \mathcal{N}(y)$$

$$g_0(x) = y(x_0)e^{-(x-x_0)} + e^{-x} \int_{x_0}^x \frac{e^s}{s} ds; \quad \mathcal{N}(y) = e^{-x} \int_{x_0}^x e^s [y^3(s) + sy^5(s)] ds \tag{3.177}$$

say with $x, x_0 \in \mathbb{R}^+$ (a sector in \mathbb{C} can be easily accommodated). Now, the expected behavior of y is, from (3.175) $x^{-1}(1 + o(1))$. We take the norm

$\|y\| = \sup_{x \geq x_0} |xy(x)|$ and S the ball $\{y : (x_0, \infty) : \|y\| < a\}$ where a is slightly larger than 1 (we need $a > 1$ as seen in (3.175)).

To evaluate the norms of the operators involved in (3.177) we need the following relatively straightforward result.

Lemma 3.178 *For $x > x_0 > m$ we have*

$$e^{-s} \int_{x_0}^x e^s s^{-m} ds \leq |1 - m/x_0|^{-1} x^{-m}$$

PROOF In a sense, the proof is by integration by parts: for $x > x_0 > m$ we have

$$e^x x^{-m} \leq |1 - m/x_0|^{-1} (e^x x^{-m})'$$

and the result follows by integration.

Exercise 3.179 (i) Show that, if $a > 1$ and if x_0 is sufficiently large, then \mathcal{N} is well defined on S and contractive there. Thus (3.177) has a unique fixed point in S . How small can you make x_0 ?

(ii) A slight variation of this argument can be used to prove the validity of the expansion (3.175). If we write $y = y_N + \delta(x)$ where y_N is the sum of the first N terms of the formal power series of y , then, by construction, y_N will satisfy the equation up to errors of order x^{-N-1} . Write an integral equation for δ and show that δ is indeed $O(x^{-N-1})$. See also §3.9h below.

□

3.9h Proving the asymptotic behavior of solutions of non-linear ODEs: An example

Consider the differential equation

$$y' - y = x^{-2} - y^3 \tag{3.180}$$

for large x . If f behaves like a power series in inverse powers of x , then y' and y^3 are small, and we can proceed as in §3.9g to get, formally,

$$y(x) \sim -x^{-2} + 2x^{-3} - 6x^{-4} + 24x^{-5} - 119x^{-6} + 708x^{-7} - 4926x^{-8} + \dots \tag{3.181}$$

How do we prove this rigorously? One way is to truncate the series in (3.181) to n terms, say the truncate is y_n , and look for solutions of (3.180) in the form $y(x) = y_n(x) + \delta(x)$. For $\delta(x)$ we write a contractive equation in a space of functions with norm $\sup_{x > x_0} |x^{n+1}\delta(x)|$.

Exercise 3.182 *Carry out the construction above and show that there is a solution with an asymptotic power series starting as in (3.181).*

Alternatively, we can write an integral equation for y itself, as in §3.9g, and show that it is contractive in a space of functions with norm $\sup_{x>x_0} |x^2 y(x)|$. Then, knowing that it is a contraction, we can iterate the operator a given number of times, with controlled errors. First,

$$e^x \int_x^\infty e^{-s} s^{-2} ds = e^x \frac{1}{x} \int_1^\infty e^{-xs} s^{-2} ds = \frac{1}{x} \int_0^\infty e^{-xs} (1+s)^{-2} ds \\ \sim \frac{1}{x^2} - \frac{2}{x^3} + \frac{6}{x^4} - \frac{24}{x^5} + \dots \quad (3.183)$$

Then,

$$y(x) = e^x \int_\infty^x e^{-s} s^{-2} ds - e^x \int_\infty^x e^{-s} y(s)^3 ds \quad (3.184)$$

together with contractivity in the chosen norm implies

$$y(x) = e^x \int_\infty^x e^{-s} s^{-2} ds + e^x \int_\infty^x e^{-s} O(s^{-6}) ds \\ = \frac{1}{x^2} - \frac{2}{x^3} + \frac{6}{x^4} - \frac{24}{x^5} + O(x^{-6}) \quad (3.185)$$

We can use (3.185) and (3.183) in (3.184) to obtain the asymptotic expansion of y to $O(x^{-10})$, and by induction, to all orders.

Exercise 3.186 Based on (3.185) and (3.183) show that y has an asymptotic power series in \mathbb{H} . In particular, the asymptotic series is differentiable (why?).

To find the power series of y , we can also note that the asymptotic series must be a formal power series solution of (3.180) (why?). Say we want five terms of the expansion. Then we insert $y = a_2 x^{-2} + a_3 x^{-3} + a_4 x^{-4} + a_5 x^{-5} + a_6 x^{-6}$ in (3.180) and solve for the coefficients. We get

$$\frac{1+a_2}{x^2} + \frac{2a_2+a_3}{x^3} + \frac{3a_3+a_4}{x^4} + \frac{4a_4+a_5}{x^5} + \frac{a_6+5a_5+a_2^3}{x^6} = 0 \quad (3.187)$$

and it follows immediately that

$$a_2 = -1, a_3 = 2, a_4 = -6, a_5 = 24, a_6 = -119 \quad (3.188)$$

Note that the signs alternate! This is true to all orders and it follows from Watson’s lemma, after BE summation.

3.9i Appendix: Some computer algebra calculations

Figure 3.5 shows a way to solve $y' + y = x^{-1} + y^3 + xy^5$ by asymptotic power series, using Maple 12. In Maple parlance, “%” means “the previous expression.” The input line following Eq. (4) is copied and pasted without change. In practice one would instead return to the line after Eq. (4) and re-run it as many times as needed. Of course, a do loop can be easily programmed, but there is no point in that unless a very high number of terms is needed.

$$\begin{aligned} &> \text{de:=y(x)=-diff(y(x),x)+1/x+y(x)^3+x*y(x)^5;} \\ \text{de} &:= y(x) = -\left(\frac{d}{dx} y(x)\right) + \frac{1}{x} + y(x)^3 + x y(x)^5 \end{aligned} \quad (1)$$

$$\begin{aligned} &> \text{rs:=rhs(de);} \\ \text{rs} &:= -\left(\frac{d}{dx} y(x)\right) + \frac{1}{x} + y(x)^3 + x y(x)^5 \end{aligned} \quad (2)$$

$$\begin{aligned} &> \text{subs(y=0,rs):asympt(%,x,8);} \\ &\quad \frac{1}{x} \end{aligned} \quad (3)$$

$$\begin{aligned} &> \text{subs(y(x)=%,rs):asympt(%,x,8):sort(%,x);} \\ &\quad \frac{1}{x} + \frac{1}{x^2} + \frac{1}{x^3} + \frac{1}{x^4} \end{aligned} \quad (4)$$

$$\begin{aligned} &> \text{subs(y(x)=%,rs):asympt(%,x,8):sort(%,x);} \\ &\quad \frac{1}{x} + \frac{1}{x^2} + \frac{3}{x^3} + \frac{7}{x^4} + \frac{15}{x^5} + \frac{25}{x^6} + O\left(\frac{1}{x^7}\right) \end{aligned} \quad (5)$$

$$\begin{aligned} &> \text{subs(y(x)=%,rs):asympt(%,x,8):sort(%,x);} \\ &\quad \frac{1}{x} + \frac{1}{x^2} + \frac{3}{x^3} + \frac{13}{x^4} + \frac{45}{x^5} + \frac{140}{x^6} + O\left(\frac{1}{x^7}\right) \end{aligned} \quad (6)$$

$$\begin{aligned} &> \text{subs(y(x)=%,rs):asympt(%,x,8):sort(%,x);} \\ &\quad \frac{1}{x} + \frac{1}{x^2} + \frac{3}{x^3} + \frac{13}{x^4} + \frac{69}{x^5} + \frac{308}{x^6} + O\left(\frac{1}{x^7}\right) \end{aligned} \quad (7)$$

$$\begin{aligned} &> \text{subs(y(x)=%,rs):asympt(%,x,8):sort(%,x);} \\ &\quad \frac{1}{x} + \frac{1}{x^2} + \frac{3}{x^3} + \frac{13}{x^4} + \frac{69}{x^5} + \frac{428}{x^6} + O\left(\frac{1}{x^7}\right) \end{aligned} \quad (8)$$

$$\begin{aligned} &> \text{subs(y(x)=%,rs):asympt(%,x,8):sort(%,x);} \\ &\quad \frac{1}{x} + \frac{1}{x^2} + \frac{3}{x^3} + \frac{13}{x^4} + \frac{69}{x^5} + \frac{428}{x^6} + O\left(\frac{1}{x^7}\right) \end{aligned} \quad (9)$$

FIGURE 3.5: Maple 12 output.

3.10 Singular perturbations

3.10a Introduction to the WKB method

In problems depending analytically on a small parameter, internal or external, the dependence of the solution on this parameter may be analytic (*regular*)

perturbation) or not (*irregular perturbation*). Ordinary differential equations depending on a small parameter are singularly perturbed when the perturbation is such that, in a formal series solution, the highest derivative is formally small. In this case, in a formal successive approximation scheme the highest derivative is first discarded, then it appears in the corrections and it is thereby iterated upon. This, as we have seen in many examples, leads to divergent expansions. Furthermore, there should exist formal solutions other than power series, since the procedure above obviously yields a space of solutions of dimensionality strictly smaller than the degree of the equation.

An example is the Schrödinger equation

$$-\epsilon^2 \psi'' + V(x)\psi - E\psi = 0 \tag{3.189}$$

for small ϵ , which will be studied in more detail later. In an ϵ -power series, ψ'' is subdominant⁷. The leading approximation would be $(V(x) - E)\psi = 0$ or $\psi = 0$ which is not an admissible solution.

Similarly, in

$$z^2 f' + f = z^2 \quad (z \text{ near zero}) \tag{3.190}$$

the presence of z^2 in front of f' makes f' subdominant if $f \sim z^p$ for some p . In this sense the Airy equation (3.209) below, is also singularly perturbed, at $x = \infty$. It turns out that in many of these problems the behavior of solutions is exponential in the parameter, generically yielding level one transseries, studied in the sequel, of the form Qe^P where P and Q have algebraic behavior in the parameter. An exponential substitution of the form $f = e^w$ should then make the leading behavior algebraic.

3.10b Singularly perturbed Schrödinger equation: Setting and heuristics

We look at (3.189) under the assumption that $V \in C^\infty(\mathbb{R})$ and would like to understand the behavior of solutions for small ϵ .

3.10b.1 Heuristics

Assume $V \in C^\infty$ and that the equation $V(x_0) = E$ has finitely many solutions.

Applying the WKB transformation $\psi = e^w$ (for further discussions on the reason this works, and for generalizations see §4.9, and 41 on p. 134.

$$-\epsilon^2 w'^2 - \epsilon^2 w'' + V(x) - E = -\epsilon^2 w'^2 - \epsilon^2 w'' + U(x) = 0 \tag{3.191}$$

where, near an x_0 where

$$U(x_0) \neq 0 \tag{3.192}$$

⁷Meaning that it is asymptotically much less than other terms in the equation.

the only consistent balance⁸ is between $-\epsilon^2 w'^2$ and $V(x) - E$ with $\epsilon^2 w''$ much smaller than both. For that to happen we need

$$\epsilon^2 U^{-1} h' \ll 1 \quad \text{where } h = w' \quad (3.193)$$

We place the term $\epsilon^2 h'$ on the right side of the equation and set up the iteration scheme

$$h_n^2 = \epsilon^{-2} U - h'_{n-1}; \quad h_{-1} = 0 \quad (3.194)$$

or

$$h_n = \pm \frac{\sqrt{U}}{\epsilon} \sqrt{1 - \frac{\epsilon^2 h'_{n-1}}{U}}; \quad h_{-1} = 0 \quad (3.195)$$

Under the condition (3.193) the square root can be Taylor expanded around 1,

$$h_n = \pm \frac{\sqrt{U}}{\epsilon} \left(1 - \frac{1}{2} \epsilon^2 \frac{h'_{n-1}}{U} - \frac{1}{8} \epsilon^4 \left(\frac{h'_{n-1}}{U} \right)^2 + \dots \right) \quad (3.196)$$

We thus have

$$h_0 = \pm \epsilon^{-1} U^{1/2} \quad (3.197)$$

$$h_1 = \pm \epsilon^{-1} U^{1/2} \left(1 \pm \epsilon^2 \frac{h'_0}{U} \right) = \pm \epsilon^{-1} U^{1/2} - \frac{1}{4} \frac{U'}{U} \quad (3.198)$$

$$h_2 = \pm \epsilon^{-1} U^{1/2} - \frac{1}{4} \frac{U'}{U} + \epsilon \left(-\frac{5}{32} \frac{(U')^2}{U^{5/2}} + \frac{1}{8} \frac{U''}{U^{3/2}} \right) \quad (3.199)$$

and so on. We can check that the procedure is formally sound if $\epsilon^2 U^{-1} h'_0 \ll 1$ or

$$\epsilon U' U^{-3/2} \ll 1 \quad (3.200)$$

Formally we have

$$w = \pm \epsilon^{-1} \int U^{1/2}(s) ds - \frac{1}{4} \ln U + \dots \quad (3.201)$$

and thus

$$\psi \sim U^{-1/4} e^{\pm \epsilon^{-1} \int U^{1/2}(s) ds} \quad (3.202)$$

⁸As the parameter, ϵ in our case, gets small, various terms in the equation contribute unevenly. Some become relatively large (the dominant ones) and some are small (the subdominant ones). If no better approach is presented, one tries all possible combinations, and rules out those which lead to conclusions inconsistent with the size assumptions made. The approach roughly described here is known as the method of dominant balance [6]. It is efficient but heuristic and has to be supplemented by rigorous proofs at a later stage of the analysis.

If we include the complete series in powers of ϵ in (3.202) we get

$$\psi \sim \exp\left(\pm\epsilon^{-1} \int U^{1/2}(s)ds\right) U^{-1/4} (1 + \epsilon F_1(x) + \epsilon^2 F_2(x) + \dots) \quad (3.203)$$

There are two possibilities compatible with our assumption about x_0 , namely $V(x_0) > E$ and $V(x_0) < E$. In the first case there is (formally) an exponentially small solution and an exponentially large one, in the latter two rapidly oscillating ones.

The points where (3.200) fails are called *turning points*. Certainly if $|U(x_1)| > \delta$, then (3.200) holds near x_1 , for ϵ small enough (depending on δ). In the opposite direction, assume $U'U^{-3/2} = \phi$ is bounded; integrating from $x_0 + \epsilon$ to x we get $-2(U(x)^{-1/2} + U(x_1)^{-1/2}) = \int \phi(s)ds$, and thus $U(x_0 + \epsilon)^{-1/2}$ is uniformly bounded near x_0 . For instance if U has a simple root at $x = 0$, the only case that we will consider here (but multiple roots are not substantially more difficult) then condition (3.200) reads

$$x \gg \epsilon^{2/3} \quad (3.204)$$

The region where this condition holds is called *outer region*.

3.10c Formal reexpansion and matching

Often, on the edge of validity, the growth structure of the terms of the series (or, more generally, transseries) suggests the type of expansion it should be matched to in an adjacent region; thereby this suggests what approximation should be used in the equation as well, in a new regime. We can observe this interesting phenomenon of matching by reshuffling, on the formal solutions of (3.189) close to a turning point. We assumed that $U \in C^\infty$ and U has finitely many zeros. Suppose $U(0) = 0$ and $U'(0) = a > 0$. If we look at the expansion (3.199) in a neighborhood of $x = 0$ and approximate U by its Taylor series at zero $U(x) = ax + bx^2 + \dots$

$$h_2 = \frac{\sqrt{ax}}{\epsilon} \left(1 + \frac{bx}{2a}\right) + -\frac{1}{4x} \left(1 + \frac{bx}{a} + \dots\right) - \frac{5z}{32\sqrt{ax^5}} \left(1 - \frac{bx}{10a} + \dots\right) \quad (3.205)$$

and in general we would get

$$h_n = \frac{\sqrt{x}}{\epsilon} (y_0 + \xi y_1 + \xi^2 y_2 + \dots); \quad \xi = \frac{\epsilon}{x^{3/2}} \quad (3.206)$$

where

$$y_j = a_{j0} + a_{j1}x + a_{j2}x^2 + \dots = a_{j0} + a_{j1} \frac{\epsilon^{2/3}}{\xi^{2/3}} + a_{j2} \frac{\epsilon^{4/3}}{\xi^{4/3}} + \dots \quad (3.207)$$

We note that now the expansion has *two* small parameters, ϵ and x ; these cannot be chosen small *independently*: the condition if $\xi \ll 1$ has to be

satisfied to make asymptotic sense of (3.206). This would carry us down to values of x such that, say, $\xi \ll 1/\ln|\epsilon|$. §6 is devoted to the study of matching, at the level of transseries.

3.10d The equation in the inner region; matching subregions

In a small region where (3.200) fails, called *inner* region, a different approximation will be sought. We see that $V(x) - E = V'(0)x + x^2h(x) =: \alpha x + x^2h(x)$ where $h(x) \in C^\infty(\mathbb{R})$. We then write

$$-\epsilon^2\psi'' + \alpha x = -x^2h(x)\psi \quad (3.208)$$

and treat the right side of (3.208) as a small perturbation. The substitution $x = \epsilon^{2/3}t$ makes the leading equation an Airy equation:

$$-\psi'' + \alpha t\psi = -\epsilon^{2/3}t^2h(\epsilon^{2/3}t)\psi \quad (3.209)$$

which is a regularly perturbed equation! For a perturbation method to apply, we merely need that $x^2h(x)\psi$ in (3.208) is much smaller than the lhs, roughly requiring $x \ll 1$. This shows that the inner and outer regions overlap, there is a subregion —*the matching region*— where both expansions apply, and where, by equating them, the free constants in each of them can be linked. In the matching region, *maximal* balance occurs, in that a larger number of terms participate in the dominant balance. Indeed, if we examine (3.191) near $x = 0$, we see that $w'^2 \gg w''$ if $\epsilon^{-2}x \gg \epsilon^{-1}x^{-1/2}$, where we used (3.197). In the transition region, all terms in the middle expression in (3.191) participate equally.

3.10e Outer region: Rigorous analysis

We first look at a region where $U(x)$ is bounded away from zero. We will write $U = F^2$.

Proposition 3.210 *Let $F \in C^\infty(\mathbb{R})$, $F^2 \in \mathbb{R}$, and assume $F(x) \neq 0$ in $[a, b]$. Then for small enough ϵ there exists a fundamental set of solutions of (3.189) in the form*

$$\psi_\pm = \Phi_\pm(x; \epsilon) \exp \left[\pm \epsilon^{-1} \int F(s) ds \right] \quad (3.211)$$

where $\Phi_\pm(x; \epsilon)$ are C^∞ in $\epsilon > 0$.

PROOF We show that there exists a fundamental set of solutions in the form

$$\psi_\pm = \exp \left[\pm \epsilon^{-1} R_\pm(x; \epsilon) \right] \quad (3.212)$$

where $R_\pm(x; \epsilon)$ are C^∞ in ϵ . The proof is by rigorous WKB.

Note first that linear independence is immediate, since for small enough ϵ the ratio of the two solutions cannot be a constant, given their ϵ behavior.

We take $\psi = e^{w/\epsilon}$ and get, as before, to leading order $w' = \pm F$. We look at the plus sign case, the other case being similar. It is then natural to substitute $w' = F + \delta$; we get

$$\delta' + 2\epsilon^{-1}F\delta = -F' - \epsilon^{-1}\delta^2 \tag{3.213}$$

which we transform into an integral equation by treating the right side as if it was known and integrating the resulting linear inhomogeneous differential equation. Setting $H = \int F$ the result is

$$\delta = -e^{-\frac{2H}{\epsilon}} \int_a^x F'(s)e^{\frac{2H(s)}{\epsilon}} ds - \frac{1}{\epsilon} e^{-\frac{2H}{\epsilon}} \int_a^x \delta^2(s)e^{\frac{2H(s)}{\epsilon}} ds =: J(\delta) =: \delta_0 + N(\delta) \tag{3.214}$$

We assume that $F > 0$ on (a, b) , the case $F < 0$ being very similar. The case $F \in i\mathbb{R}$ is not too different either, as we will explain at the end.

Let now $\|F'\|_\infty = A$ in (a, b) and assume also that $\inf_{s \in (a,b)} |U(s)| = B^2 > 0$ (recall that $U = F^2$).

Lemma 3.215 *For small ϵ , the operator J is contractive in a ball $\mathcal{B} := \{\delta : \|\delta\|_\infty \leq 2AB^{-1}\epsilon\}$.*

PROOF (i) Preservation of \mathcal{B} . We have

$$|\delta_0(x)| \leq Ae^{-\frac{2}{\epsilon}H(x)} \int_a^x e^{\frac{2}{\epsilon}H(s)} ds$$

By assumption, H is increasing on (a, b) and $H' \neq 0$ and thus, by the Laplace method, cf. [Proposition 3.18](#), for small ϵ we have (since $H' = \sqrt{U}$),

$$|\delta_0(x)| \leq 2Ae^{-\frac{2}{\epsilon}H(x)} \frac{e^{\frac{2}{\epsilon}H(x)}}{\frac{2}{\epsilon}H'(x)} \leq \epsilon AB^{-1}$$

Note We need this type of estimates to be uniform in $x \in [a, b]$ as $\epsilon \rightarrow 0$. To see that this is the case, we write

$$\begin{aligned} \int_a^x e^{\frac{2}{\epsilon}H(s)} ds &= \int_a^x e^{\frac{2}{\epsilon}H(s)} \frac{2F(s)}{\epsilon} \frac{\epsilon}{2F(s)} ds \\ &\leq \frac{\epsilon}{2B} e^{\frac{2}{\epsilon}H(s)} \Big|_a^x \leq \frac{\epsilon}{2B} e^{\frac{2}{\epsilon}H(x)} \end{aligned} \tag{3.216}$$

Similarly,

$$\left| \frac{1}{\epsilon} e^{-\frac{2H}{\epsilon}} \int_a^x \delta^2(s) e^{\frac{2H(s)}{\epsilon}} ds \right| \leq 2\epsilon^2 A^2 B^{-3}$$

and thus, for small ϵ and $\delta \in \mathcal{B}$ we have

$$J(\delta) \leq \epsilon^{-1} AB^{-1} + 2\epsilon^2 A^2 B^{-3} \leq 2\epsilon AB^{-1}$$

(ii) *Contractivity.* We have, with $\delta_1, \delta_2 \in \mathcal{B}$, using similarly Laplace’s method,

$$\begin{aligned} |J(\delta_2) - J(\delta_1)| &\leq \frac{1}{\epsilon} e^{-\frac{2H}{\epsilon}} \int_a^x |\delta_2(s) - \delta_1(s)| |\delta_2(s) + \delta_1(s)| e^{\frac{2H(s)}{\epsilon}} ds \\ &\leq \frac{2\epsilon A}{B^2} \|\delta_2 - \delta_1\| \end{aligned} \quad (3.217)$$

and thus the map is contractive for small enough ϵ . □

Note. We see that the conditions of preservation of \mathcal{B} and contractivity allow for a dependence of (a, b) on ϵ . Assume for instance that $a, b > 0$ and $V(x) = E$ has no root in $[a, b + \gamma]$ with $\gamma > 0$, and that a is small. Assume further that $V(0) = E$ is a simple root, $V'(0) = \alpha \neq 0$. Then for some $C > 0$ we have $B \geq Cm^2 a^2$ and the condition of contractivity reads

$$\frac{\epsilon^2 |\alpha|}{|\alpha|^3} < 1$$

i.e., $a > (\epsilon/|\alpha|)^{2/3}$ and for small enough ϵ this is also enough to ensure preservation of \mathcal{B} . We thus find that the equation $\delta = J(\delta)$ has a unique solution and that, furthermore, $\|\delta\| \leq \text{const.}\epsilon$. Using this information and (3.217) which implies

$$\|J(\delta)\| \leq \frac{\epsilon A}{B^2} 2AB^{-1}\epsilon$$

we easily get that, for some constants $C_i > 0$ independent on ϵ ,

$$|\delta - \delta_0| \leq C_1 \epsilon |\delta| \leq C_1 \epsilon |\delta_0| + C_1 \epsilon |\delta - \delta_0|$$

and thus

$$|\delta - \delta_0| \leq C_2 \epsilon |\delta_0|$$

and thus, applying again Laplace’s method we get

$$\delta \sim \frac{-\epsilon F'}{2F} \quad (3.218)$$

which gives

$$\psi \sim \exp\left(\pm\epsilon^{-1} \int U^{1/2}(s)ds\right) U^{-1/4}$$

The proof of the C^∞ dependence on ϵ can be done by induction, using (3.218) to estimate δ^2 in the fixed point equation, to get an improved estimate on δ , etc.

In the case $F \in i\mathbb{R}$, the proof is the same, by using the stationary phase method instead of the Laplace method.

□

3.10f Inner region: Rigorous analysis

By rescaling the independent variable we may assume without loss of generality that $\alpha = 1$ in (3.209) which we rewrite as

$$-\psi'' + t\psi = -\epsilon^{2/3}t^2h_1(\epsilon^{2/3}t)\psi := f(t) \tag{3.219}$$

which can be transformed into an integral equation in the usual way,

$$\psi(t) = -\text{Ai}(t) \int^t f(s)\text{Bi}(s)ds + \text{Bi}(t) \int^t f(s)\text{Ai}(s)ds + C_1\text{Ai}(t) + C_2\text{Bi}(t) \tag{3.220}$$

where Ai, Bi are the Airy functions, with the asymptotic behavior

$$\text{Ai}(t) \sim \frac{1}{\sqrt{\pi}}t^{-1/4}e^{-\frac{2}{3}t^{\frac{3}{2}}}; \quad \text{Bi}(t) \sim \frac{1}{\sqrt{\pi}}t^{-1/4}e^{\frac{2}{3}t^{\frac{3}{2}}}; \quad t \rightarrow +\infty \tag{3.221}$$

and

$$|t^{-1/4}\text{Ai}(t)| < \text{const.}, \quad |t^{-1/4}\text{Bi}(t)| < \text{const.} \tag{3.222}$$

as $t \rightarrow -\infty$. In view of (3.221) we must be careful in choosing the limits of integration in (3.220). It is important to ensure that the second term does not have a fast growth as $t \rightarrow \infty$, and for this purpose we need to integrate from t towards infinity in the associated integral. For that, we ensure that the maximum of the integrand is achieved *at or near the variable endpoint of integration*. Then Laplace’s method shows that the leading contribution to the integral comes from the variable endpoint of integration as well, which allows for the opposite exponentials to cancel out. We choose to look at an interval in the original variable $x \in I_M = [-M, M]$ where we shall allow for ϵ -dependence of M . We then write the integral equation with concrete limits in the form below, which we analyze in I_M .

$$\begin{aligned} \psi(t) = & -\text{Ai}(t) \int_0^t f(s)\text{Bi}(s)ds + \\ & \text{Bi}(t) \int_M^t f(s)\text{Ai}(s)ds + C_1\text{Ai}(t) + C_2\text{Bi}(t) = J\psi + \psi_0 \end{aligned} \quad (3.223)$$

Proposition 3.224 *For some positive const., if ϵ is small enough (3.223) is contractive in the sup norm if $M \leq \text{const.}\epsilon^{2/5}$.*

PROOF Using the Laplace method, we see that for $t > 0$ we have

$$t^{-1/4}e^{-\frac{2}{3}t^{\frac{3}{2}}} \int_0^t s^{-1/4}e^{\frac{2}{3}s^{\frac{3}{2}}} ds \leq \text{const.}(|t| + 1)^{-1}$$

and also

$$\begin{aligned} t^{-1/4}e^{\frac{2}{3}t^{\frac{3}{2}}} \int_t^M s^{-1/4}e^{-\frac{2}{3}s^{\frac{3}{2}}} ds & \leq t^{-1/4}e^{\frac{2}{3}t^{\frac{3}{2}}} \int_t^\infty s^{-1/4}e^{-\frac{2}{3}s^{\frac{3}{2}}} ds \\ & \leq \text{const.}(|t| + 1)^{-1} \end{aligned} \quad (3.225)$$

and thus for a constant independent of ϵ , using (3.221) we get

$$|J\psi(t)| \leq \text{const.}\epsilon^{2/3}(|t| + 1)^{-1} \sup_{s \in [0,t]} |\psi(s)|$$

for $t > 0$. For $t < 0$ we use (3.222) and obtain

$$\left| \text{Ai}(t) \int_M^t f(s)\text{Bi}(s)ds \right| \leq (1 + |t|)^{-1/4} \sup_{s \in [-t,0]} |f(s)| \left(\text{const.} + \int_t^0 s^{-1/4}ds \right)$$

and get for a constant independent of ϵ

$$|J\psi(t)| \leq \text{const.}\epsilon^{2/3}(1 + |t|)^{5/2} \leq \text{const.}\epsilon^{2/3}(\epsilon^{-2/3}M)^{5/2} < 1$$

We see that for small enough ϵ , the regions where the outer and inner equations are contractive overlap. This allows for performing asymptotic matching in order to relate these two solutions. For instance, from the contractivity argument it follows that

$$\psi = (1 - J)^{-1}\psi_0 = \sum_{k=0}^\infty J^k\psi_0$$

giving a power series asymptotics in powers of $\epsilon^{2/3}$ for ψ . □

3.10g Matching

We may choose for instance $x = \text{const.}\epsilon^{1/2}$ for which the inner expansion (in powers of $\epsilon^{2/3}$) and the outer expansion (in powers of ϵ) are valid at the same time. We assume that x lies in the oscillatory region for the Airy functions (the other case is slightly more complicated).

We note that in this region of x the coefficient of ϵ^k of the outer expansion will be large, of order $(U'U^{-3/2})^k \sim \epsilon^{-3k/4}$. A similar estimate holds for the terms of the inner expansion. Both expansions will thus effectively be expansions in $\epsilon^{-1/4}$. Since they represent the same solution, they must agree and thus the coefficients of the two expansions are linked. This determines the constants C_1 and C_2 once the outer solution is prescribed.

For more examples see [6] and, for interesting recent developments, see [43] and [references](#) therein.

3.11 WKB on a PDE

Consider now a parabolic PDE, say the heat equation.

$$\psi_t = \psi_{xx} \tag{3.226}$$

The fact that the principal symbol is degenerate (there are fewer t than x derivatives) has an effect similar to that of a singular perturbation. If we attempt to solve the PDE by a power series

$$\psi = \sum_{k=0}^{\infty} t^k F_k(x) \tag{3.227}$$

this series will generically have zero radius of convergence. Indeed, the recurrence relation for the coefficients is $F_k = F''_{k-1}/k$ whose solution, $F_k = F_0^{(2k)}/k!$ behaves like $F_k \sim k!$ for large k , if F is analytic but not entire.

Generally, exponential solutions are expected too⁹. If we take $\psi = e^w$, looking for w large, say larger than some positive power of x in (3.226) we get

$$w_t = w_x^2 + w_{xx} \tag{3.228}$$

where the assumption of algebraic behavior of w is expected to ensure $w_x^2 \gg w_{xx}$ (since $x^{2p-2} \gg x^{p-2}$ if $p > 0$; in general, see §4.10b.2) we and so the leading equation is approximately

⁹The reason will be better understood after Borel summation methods have been studied. Divergence means that the Borel transform of the formal solution is nontrivial: it has singularities. Upon Laplace transforming it, paths of integration on different sides of the singularities give different results, and the differences are exponentially small.

$$w_t = w_x^2 \quad (3.229)$$

which can be solved by characteristics. We take $w_x = u$ and get for u the quasilinear equation

$$u_t = 2uu_x \quad (3.230)$$

with a particular solution $u = -x/(2t)$, giving $w = -x^2/(4t)$. We thus take $w = -x^2/(4t) + \delta$ and get for δ the equation

$$\delta_t + \frac{x}{t}\delta_x + \frac{1}{2t} = \delta_x^2 + \delta_{xx} \quad (3.231)$$

where we have separated the relatively small terms to the right side. We would normally solve the leading equation (the lhs of (3.231)) and continue the process, but for this equation we note that $\delta = -\frac{1}{2} \ln t$ solves not only the leading equation, but the full equation (3.231). Thus

$$w = -\frac{x^2}{4t} - \frac{1}{2} \ln t \quad (3.232)$$

which gives the classical heat kernel

$$\psi = \frac{1}{\sqrt{t}} e^{-\frac{x^2}{4t}} \quad (3.233)$$

This exact solvability is of course rather accidental, but a perturbation approach formally works in a more PDE general context.

Chapter 4

Analyzable functions and transseries

As we have seen, there is an important distinction between asymptotic expansions and asymptotic series. The operator $f \mapsto \mathcal{A}_p(f)$ which associates to f its asymptotic power series is linear as seen in §1.1c. But it has a nontrivial kernel ($\mathcal{A}_p(f) = 0$ for many nonzero functions), and thus the description through asymptotic power series is fundamentally *incomplete*. There is no unambiguous way to determine a function from its classical asymptotic series alone. On the other hand, the operator $f \mapsto \mathcal{A}(f)$ which associates to f its asymptotic *expansion* has zero kernel, but it is still false that $\mathcal{A}(f) = \mathcal{A}(g)$ implies $f = g$ (\mathcal{A} is *not* linear; see [Remark 1.25](#)). The description of a function through its asymptotic *expansion* is also incomplete.

Note: various possible trails through Chapter 4. To see how Borel summation works of formal solutions works in typical, relatively simple problems, without worrying too much about general transseries, the main prerequisites can be gotten from the introduction to §4.1, and from §4.1a, §4.1a.4, §4.1a.5, §4.2c and §4.3a. Transseries can be then thought as some kind of formal asymptotic expansions, to be defined later, involving powers, logs and exponentials, and which are operated with almost as if they were convergent. The restriction “asymptotic”, meaning that the terms can be (preferably, already are) ordered decreasingly with respect to \gg , is crucial.

For more details, the material in §4.1 and §4.2 provides a quick but not fully rigorous construction of transseries; if deemed sufficient and convincing, the rigorous construction in §4.9 can be skipped at a first reading.

Finally, a mathematically oriented reader might prefer to use §4.1 and §4.2 as a heuristic guide and focus instead on §4.9.

4.1 Analytic function theory as a toy model of the theory of analyzable functions

Let A denote the set of analytic functions at $z = 0$ (the domain of analyticity may depend on the function), let $\mathbb{C}[[z]]$ be the space of formal series in z with complex coefficients, of the form $\sum_{k=0}^{\infty} c_k z^k$, and define $\mathbb{C}_c[[z]]$ as the

subspace of series with nonzero radius of convergence. The Taylor series at zero of a function in A is also its asymptotic series at zero. Moreover, the map $\mathcal{T} : A \mapsto \mathbb{C}_c[[z]]$, the Taylor expansion operator, is an isomorphism and its inverse $\mathcal{T}^{-1} = \mathcal{S}$ is simply the operator of summation of series in $\mathbb{C}_c[[z]]$. \mathcal{T} and \mathcal{S} commute with most function operations defined on \mathcal{A} . For instance we have, with \tilde{f}, \tilde{f}_1 and \tilde{f}_2 in $\mathbb{C}_c[[z]]$

$$\begin{aligned}
 & 1. \quad \mathcal{S}\{\alpha\tilde{f}_1 + \beta\tilde{f}_2\} = \alpha\mathcal{S}\tilde{f}_1 + \beta\mathcal{S}\tilde{f}_2; & 2. \quad \mathcal{S}\{\tilde{f}_1\tilde{f}_2\} = \mathcal{S}\tilde{f}_1\mathcal{S}\tilde{f}_2; \\
 & 3. \quad \mathcal{S}\{\tilde{f}^*\} = \{\mathcal{S}\tilde{f}\}^*; & 4. \quad \mathcal{S}\{\tilde{f}'\} = \{\mathcal{S}\tilde{f}\}' ; \\
 & 5. \quad \mathcal{S}\left\{\int_0^x \tilde{f}\right\} = \int_0^x \mathcal{S}\tilde{f}; & 6. \quad \mathcal{S}\{\tilde{f}_1 \circ \tilde{f}_2\} = \mathcal{S}\tilde{f}_1 \circ \mathcal{S}\tilde{f}_2; & 7. \quad \mathcal{S}1 = 1
 \end{aligned}
 \tag{4.1}$$

where $\tilde{f}^*(z) = \overline{\tilde{f}(\bar{z})}$. All this is standard analytic function theory.

Convergent summation, \mathcal{S} , is such a good isomorphism between A and $\mathbb{C}_c[[z]]$, that usually no distinction is made between formal (albeit convergent) expansions and their sums which are actual functions. There does not even exist a notational distinction between a convergent series, as a series, and its sum as a number. Yet we can see there is a distinction, at least until we have proven convergence.

Consequences of the isomorphism to solving problems. As a result of the isomorphism, whenever a problem can be solved in $\mathbb{C}_c[[z]]$, \mathcal{S} provides an actual solution of the same problem. For example, if \tilde{y} is a formal solution of the equation

$$\tilde{y}' = \tilde{y}^2 + z \tag{4.2}$$

as a series in powers of z , with nonzero radius of convergence, and we let $y = \mathcal{S}\tilde{y}$ we may write, using (4.1),

$$(\tilde{y}' = \tilde{y}^2 + z) \Leftrightarrow (\mathcal{S}\{\tilde{y}'\} = \mathcal{S}\{\tilde{y}^2\} + z) \Leftrightarrow (y' = y^2 + z)$$

i.e., \tilde{y} is a formal solution of (4.2) iff y is an actual solution. The same reasoning would work in many problems with analytic coefficients for which solutions $\tilde{y} \in C_C[[z]]$ can be found.

On the other hand, if we return to the example in Remark 1.25, f_1 and f_2 differ by a constant C , coming from the lower limit of integration, and this C is lost in the process of calculating the asymptotic expansion. To have a complete description, clearly we must account for C . It is then natural to try to write instead

$$f_{1,2} \sim e^x \tilde{f} + C_{1,2} \tag{4.3}$$

However, Note 1.23 shows $C_{1,2}$ cannot be defined through (1.12); $C_{1,2}$ cannot be calculated as $f_{1,2} - e^x \tilde{f}$ since \tilde{f} does not converge. The right side of (4.3)

becomes for now a purely formal object, in the sense that it does not connect to an actual function in any obvious way; (4.3) is perhaps the simplest nontrivial instance of a transseries.

It is the task of the theory of analyzable functions to interpret in a natural and rigorous way expansions such as (4.3), so that expansions and functions are into a one-to-one correspondence. An isomorphism like (4.1) holds in much wider generality.

Some ideas of the theory of analyzable functions can be traced back to Euler (as seen in §1.2a), to Cauchy, to Borel, who found the first powerful technique to deal with divergent expansions, and to Dingle and Berry, who substantially extended optimal truncation methods.

In the early 1980s exponential asymptotics became a field of its own, with a number of major discoveries of Écalle, the theory of transseries and analyzable functions, and a very comprehensive generalization of Borel summation.

Setting of the problem. One operation is clearly missing from both A and $\mathbb{C}_c[[z]]$ namely division, and this severely limits the range of problems that can be solved in either A or $\mathbb{C}_c[[z]]$. The question is then, which spaces $A_1 \supset A$ and $S_1 \supset \mathbb{C}_c[[z]]$ are closed under all function operations, including division, and are such that an extension of \mathcal{T} is an isomorphism between them? (See also §1.2b). Because of the existence of an isomorphism between A_1 and the formal expansions S_1 the functions in A_1 were called *formalizable*). Exploring the limits of formalizability is at the core of the modern theory of analyzable functions. See also § 1.2b.

In addition to the obvious theoretical interest, there are many important practical applications. One of them, for some generic classes of differential systems where it has been worked out, is the possibility of solving problems starting from formal expansions, which are easy to obtain (usually algorithmically), and from which the isomorphism produces, constructively, actual solutions.

We start by looking at expansions as formal algebraic objects, to understand their structure and operations with them.

4.1a Formal asymptotic power series

Definition 4.4 For $x \rightarrow \infty$, an asymptotic power series (APS) is a formal structure of the type

$$\sum_{i=1}^{\infty} \frac{c_i}{x^{k_i}} \tag{4.5}$$

We assume that $k_i > k_j$ if $i > j$ and that there is no accumulation point of

the k_i .¹

In particular, there is a *smallest* power $k_j \in \mathbb{Z}$, possibly negative. We usually arrange that $c_1 \neq 0$, and then $j = 1$.

Examples. (1) Integer power series, i.e., series of the form

$$\sum_{k=M}^{\infty} \frac{c_k}{x^k} \quad (4.6)$$

(2) Multiseries, *finitely generated* power series, of the form

$$\sum_{k_i \geq M} \frac{c_{k_1, k_2, \dots, k_n}}{x^{\alpha_1 k_1 + \dots + \alpha_n k_n}} \quad (4.7)$$

for some $M \in \mathbb{Z}$ and $n - 1 \in \mathbb{N}$, where $\alpha_1 > 0, \dots, \alpha_n > 0$. Its generators are the *monomials* $x^{-\alpha_1}, \dots, x^{-\alpha_n}$.

Proposition 4.8 *A series of the form (4.7) can be rearranged as an APS.*

PROOF For the proof we note that for any $m \in \mathbb{N}$, the set

$$\{(k_1, k_2, \dots, k_n) \in \mathbb{Z}^n : k_i \geq M \text{ for } 1 \leq i \leq n \text{ and } \sum_{i=1}^n \alpha_i k_i \leq m\}$$

is finite. Indeed, k_i are bounded below, $\alpha_i > 0$ and $\sum_{i=1}^n \alpha_i k_i \rightarrow \infty$ if at least one of the sequences $\{k_{i_j}\}_{i_j}$ is unbounded. Thus, there are finitely many distinct powers x^{-p} , p between m and $m + 1$.

Exercise 4.9 *As a consequence show that:*

(1) *there is a minimum ν so that*

$$\nu = \alpha_1 k_1 + \dots + \alpha_n k_n \text{ for some } k_1, \dots, k_n \geq M\}$$

(2) *The set*

$$J := \{\nu : \nu = \alpha_1 k_1 + \dots + \alpha_n k_n \text{ for some } k_1, \dots, k_n \geq M\}$$

is countable with no accumulation point. Furthermore J can be linearly ordered

$$\nu_1 < \nu_2 < \dots < \nu_k < \dots$$

and all the sets

$$J_i := \{k_1, \dots, k_j \geq M : \nu_i = \alpha_1 k_1 + \dots + \alpha_n k_n\}$$

are finite.

Complete the proof of the proposition.

¹ \mathbb{N} could be replaced by an ordinal. However, for power series, under the nonaccumulation point assumption, there would be no added generality.

□

Thus (4.7) can be written in the form (4.5). The largest term in a series S is the dominance of S :

Definition 4.10 (of dom). *If S is a nonzero APS of the type (4.5) we define $\text{dom}(S)$ to be $c_{i_1}x^{-k_{i_1}}$ where i_1 is the first i in (4.5) for which $c_i \neq 0$ (as noted above, we usually arrange $c_1 \neq 0$). We write $\text{dom}(S) = 0$ iff $S = 0$.*

4.1a.1 Operations with APS

Note 4.11 *The following operations are defined in a natural way and have the usual properties: $+$, $-$, \times , $/$ differentiation and composition $S_1 \circ S_2$ where S_2 is a series such that $k_1 < 0$. For composition and division see the note after Proposition 4.18. For instance,*

$$\sum_{k=0}^{\infty} \frac{c_j}{x^{\nu_j}} \sum_{l=0}^{\infty} \frac{d_l}{x^{\eta_l}} = \sum_{k,l=0}^{\infty} \frac{c_j d_l}{x^{\nu_j + \eta_l}} \tag{4.12}$$

Exercise 4.13 (*) *Show that the last series in (4.12) can be written in the form (4.5).*

Exercise 4.14 (*) *Show that finitely generated power series are closed under the operations in Note 4.11.*

4.1a.2 Asymptotic order relation

If $C_1, C_2 \neq 0$, we naturally write (remember that $x \rightarrow +\infty$ and the definition of \ll in (1.8) and (1.9))

$$C_1x^p \ll C_2x^q \quad \text{iff} \quad p < q$$

Definition 4.15 *For two nonzero APSs S_1, S_2 we write $S_1 \gg S_2$ iff $\text{dom}(S_1) \gg \text{dom}(S_2)$.*

Proposition 4.16 $\text{dom}(S_1S_2) = \text{dom}(S_1)\text{dom}(S_2)$, and if $\text{dom}(S) \neq \text{const}$ then $\text{dom}(S') = \text{dom}(S)'$.

PROOF Exercise. □

Thus we have

Proposition 4.17 (See note (4.11)).

(i) $S_1 \ll T$ and $S_2 \ll T$ imply $S_1 + S_2 \ll T$ and for any nonzero S_3 we have $S_1S_3 \ll S_2S_3$.

(ii) $S_1 \gg T_1$ and $S_2 \gg T_2$ imply $S_1 S_2 \gg T_1 T_2$.

(iii) $S \ll T$ implies $\frac{1}{S} \gg \frac{1}{T}$.

(iv) $S \ll T \ll 1$ implies $S' \ll T' \ll 1$ and $1 \ll S \ll T$ implies $S' \ll T'$ (prime denotes differentiation). Also, $s \ll 1 \Rightarrow s' \ll s$ and $L \gg 1 \Rightarrow L \gg L'$. $S' \gg T'$ and $T \gg 1$ implies $S \gg T$. Also $1 \gg S' \gg T'$ implies $S \gg T$.

(v) There is the following trichotomy for two nonzero APSs : $S \ll T$ or $S \gg T$ or else $\frac{S}{T} - C \ll 1$ for some constant C .

PROOF Exercise. □

Proposition 4.18 Any nonzero APS, S , can be uniquely decomposed in the following way

$$S = L + C + s$$

where C is a constant and L and s are APS, with the property that L has nonzero coefficients only for positive powers of x (L is purely large) and s has nonzero coefficients only for negative powers of x (s is purely small; this is the same as, simply, small).

PROOF Exercise. □

Exercise 4.19 (*) Show that any nonzero series can be written in the form $S = D(1 + s)$ where $D = \text{dom}(S)$ and s is a small series.

Exercise 4.20 Show that the large part of an APS has only finitely many terms.

Exercise 4.21 (*) Show that for any coefficients a_1, \dots, a_m, \dots and small series s the formal expression

$$1 + a_1 s + a_2 s^2 + \dots \tag{4.22}$$

can be rearranged as an APS. (A proof in a more general setting is given in §4.9.)

Note 4.23 Let S be a nonzero series and $D = C_1 x^{-\nu_1} = \text{dom}(S)$. We define $1/D = (1/C_1)x^{\nu_1}$ and

$$\frac{1}{S} = \frac{1}{D}(1 - s + s^2 - s^3 \dots) \tag{4.24}$$

and more generally

$$S^\beta := C_1^\beta x^{-\nu_1 \beta} \left(1 + \beta s + \frac{1}{2} \beta(\beta - 1) s^2 + \dots \right) \tag{4.25}$$

The composition of two series $S = \sum_{k=0}^{\infty} s_k x^{-\nu_k}$ and L where L is large is defined as

$$S \circ L := \sum_{k=0}^{\infty} s_k L^{-\nu_k} \tag{4.26}$$

Exercise 4.27 (*) Show that (4.26) defines a formal power series which can be written in the form (4.5).

Examples

Proposition 4.28 The differential equation

$$y' + y = \frac{1}{x} + y^3 \tag{4.29}$$

has a unique solution as an APS which is purely small.

PROOF For the existence part, note that direct substitution of a formal integer power series $y_0 = \sum_{k=1}^{\infty} c_k x^{-k}$ leads to the recurrence relation $c_1 = 1$ and for $k \geq 2$,

$$c_k = (k - 1)c_{k-1} + \sum_{k_1+k_2+k_3=k; k_i \geq 1} c_{k_1} c_{k_2} c_{k_3}$$

for which direct induction shows the existence of a solution, and we have

$$y_0 = \frac{1}{x} + \frac{1}{x^2} + \frac{3}{x^3} + \frac{12}{x^4} + \frac{60}{x^5} + \dots$$

For uniqueness assume y_0 and y_1 are APS solutions and let $\delta = y_1 - y_0$. Then δ satisfies

$$\delta' + \delta = 3y_0^2\delta + 3y_0\delta^2 + \delta^3 \tag{4.30}$$

Since by assumption $\delta \ll 1$ we have $\text{dom}(\delta') \ll \text{dom}(\delta)$ and similarly $\text{dom}(3y_0^2\delta + 3y_0\delta^2 + \delta^3) \ll \text{dom}(\delta)$. But this implies $\text{dom}(\delta) = 0$ and thus $\delta = 0$. There are further formal solutions, not within APS but as more general *transseries* containing exponentially small terms. □

4.1a.3 The exponential, as a formal object

Proposition 4.31 If s is a purely small series, then the equation $y' = s'y$ (suggesting $y = Ce^s$) has APS solutions of the form $C + s_1$ where s_1 is small. If we choose $C = 1$ then $s_1 = s_{1;1}$ is uniquely defined.

We define, according to the previous proposition, $e^s = 1 + s_{1;1}$; $1 + s_{1;1}$ is simply the familiar Maclaurin series of the exponential.

PROOF Straightforward verification. □

However, e^x , and more generally e^L where $L \gg 1$, is not definable in terms of APS.

Proposition 4.32 *The differential equations $f' = f$ (*) has no nonzero APS solution.*

PROOF By Proposition 4.17, if $f \neq 0$ is an APS, then $f' \ll f$, so $f' = f$ is not possible. □

Thus we adjoin a solution of (*) as a new “formal monomial” e^x ,² determined by the equation only up to a multiplicative constant, derive its properties and check for consistency of the extension (meaning in this case that the new element is compatible with the structure it was adjoined to). Monomials are by definition positive, so we postulate $e^x > 0$.³ Then, formally integrating (*), we see that $e^x > const$ and inductively, $e^x > const x^n$ for any n . Thus $e^x \gg x^n$ for all n . Consistency of the definition is a consequence of the existence of transseries, constructed in detail in §4.9 (with a sketch in §4.2b).

Remark 4.33 In a space of expansions containing series and the exponential, and where $y' = 0$ means y is a constant, the general solution of $y' + y = 0$ is Ce^{-x} . Indeed, we may multiply by e^x and get $(ye^x)' = 0$, i.e., $ye^x = C$ or $y = Ce^{-x}$.

Thus we simply *define* the exponential as follows. If L is a large series, say purely large, then we introduce the composition e^L as a new element (it cannot be defined based on APS and e^x). To preserve the properties of differentiation we should have $(e^L)' = L'e^L$. Then e^L is a solution of the equation $f' = L'f$; since $(e^{L_1}e^{L_2})$ is a solution of $f' = (L'_1+L'_2)f$, for consistency, we should define $e^{L_1}e^{L_2} = e^{L_1+L_2}$. If $L_1 = -L_2$, then $e^{L_1}e^{L_2} = const$ which, by symmetry, should be one. This suggests the following:

Definition 4.34 *In general if $S = L+C+s$ we write $e^S = C(1+s_{1;1})e^L$ where e^L is to be thought of as a primary symbol, subject to the further definitions $e^{L_1+L_2} = e^{L_1}e^{L_2}$ and $(e^L)' = L'e^L$.*

²The existence of a function solution to (*) is not relevant here, since APSs are not functions.

³We know that this cannot be inconsistent with the equation and order relation, since it is true for the actual exponential.

After we have adjoined these new elements, the general solution of

$$f' + f = x^{-1} \tag{4.35}$$

is

$$\tilde{y}_0 + Ce^{-x} := \sum_{k=0}^{\infty} \frac{k!}{x^{k+1}} + Ce^{-x} \tag{4.36}$$

Indeed, if \tilde{y} is any solution of (4.35) then $\tilde{f} = \tilde{y} - \tilde{y}_0$ satisfies the homogeneous equation $f' + f = 0$. The rest follows from Remark 4.33.

To formally solve (4.35) within power series, only algebraic operations and differentiation are needed. However, within the differential field⁴, generated by $1/x$,⁵ (4.36) has no nonzero solution, as seen in the exercise below.

Exercise 4.37 (*) Note that the space of convergent power series of the form $\sum_{k \geq k_0} c_k x^{-k}$ with $k_0 \in \mathbb{Z}$ (possibly negative) is a differential field where (4.35) has no solution.

This shows again that the space of transseries has to have many “innate” objects, lest simple equations cannot be solved. If there are too many formal elements though, association with true functions is endangered. It is a delicate balance.

4.1a.4 Exponential power series (EPS)

A simple example of EPS is a formal expression of the type

$$\sum_{i,j=1}^{\infty} \frac{c_{ij}}{e^{\lambda_i x} x^{k_j}} \tag{4.38}$$

where λ_i are increasing in i and k_j are increasing in j . Again the usual operations are well defined on EPS (except for composition, to be defined later, together with transseries).

The order relation, compatible with the discussion in § 4.1a.3, is defined by $e^{\lambda_1 x} x^{k_2} \gg e^{\lambda_3 x} x^{k_4}$ iff $\lambda_1 > \lambda_3$ or if $\lambda_1 = \lambda_3$ and $k_2 > k_4$. Consistent with this order relation it is then natural to reorder the expansion (4.38) as follows

$$\sum_{i=1}^{\infty} e^{-\lambda_i x} \sum_{j=1}^{\infty} \frac{c_{ij}}{x^{k_j}} \tag{4.39}$$

Then we can still define the dominance of a structure of the form (4.38).

⁴That is, roughly, a differential algebra with a consistent division. A (commutative) differential algebra is a structure endowed with the algebraic operations $+$, $-$, \times , multiplication by constants and differentiation, and with respect to these operations behave as expected; see e.g., [42].

⁵There is a minimal differential field containing $1/x$, by definition the one generated by $1/x$.

As another simple example of an EPS, let us find the formal antiderivative of e^{x^2} . We write $y' = e^{x^2}$ and, for instance by WKB we see that y is of order e^{x^2} . We write $y = ge^{x^2}$ and get

$$g' + 2xg = 1 \quad (4.40)$$

where a power series solution is found by noting that, within APSs $g'/x \ll g$

$$g = \frac{1}{2x} - \frac{1}{2x}g' \quad (4.41)$$

and by formal iteration we get

$$\tilde{g}_0 = \frac{1}{2x} + \frac{1}{4x^3} + \frac{1 \cdot 3}{8x^5} + \frac{1 \cdot 3 \cdot 5}{16x^7} \cdots = \sum_{k=0}^{\infty} \frac{(2k-1)!!}{2^{k+1}x^{2k+1}} \quad ((-1)!! = 1) \quad (4.42)$$

(compare with §3.1). The general solution is \tilde{g}_0 plus the general solution of the associated homogeneous equation $g' + 2xg = 0$, Ce^{-x^2} . Thus

$$EPS \left(\int e^{x^2} \right) = e^{x^2} \sum_{k=0}^{\infty} \frac{(2k-1)!!}{2^{k+1}x^{2k+1}} + C, \quad x \rightarrow \infty$$

4.1a.5 Exponential power series solutions for (4.29)

To show how transseries arise naturally as solutions of ODEs we continue the formal analysis of (4.29).

To simplify notation, we drop the tildes from formal asymptotic expansions. We have obtained, in Proposition 4.17 a formal series solution (4.29), y_0 . We look for possible further solutions. We take $y = y_0 + \delta$. The equation for δ is (4.30) where we search for solutions $\delta \ll 1$, in which assumption the terms on the right side of the equation are subdominant (see footnote 8 on p. 72). We have $\delta' + \delta(1 + o(1)) = 0$ thus $\delta = Ce^{-x+o(x)}$ and this suggests the substitution $\delta = e^w$. We get

$$w' + 1 = 3y_0^2 + 3y_0e^w + e^{2w}$$

and since $e^w = \delta \ll 1$, all the terms on the right side are $\ll 1$, and the dominant balance (footnote 8, p. 72) can only be between the terms on the left side, thus $w = -x + C + w_1$. Taking for now $C = 0$ (we'll examine the role of C later), we get

$$w'_1 = 3y_0^2 + 3y_0e^{-x}e^{w_1} + e^{-2x+2w_1}$$

We have $y_0e^{-x}e^{w_1} = y_0\delta = y_0e^{-x+o(x)}$. Since $y_0e^{-x}e^{w_1} \ll x^{-n}$ for any n and thus $w'_1 = O(x^{-2})$; therefore $w_1 = O(x^{-1})$. Thus, $e^{w_1} = 1 + w_1 + w_1^2/2 + \dots$ and consequently $3y_0e^{-x}e^{w_1} + e^{-2x+2w_1}$ is negligible with respect to y_0^2 . Again by dominant balance, to leading order, we have $w'_1 = 3y_0^2$ and thus $w_1 =$

$\int 3y_0^2 + w_2 := \phi_1 + w_2$ (ϕ_1 is a formal power series). To leading order, we obtain

$$w'_2 = 3y_0e^{-x}$$

and thus $w_2 = \phi_2e^{-x}$ where ϕ_2 is a power series. Continuing this process of iteration, we can see inductively that w must be of the form

$$w = -x + \sum_{k=0}^{\infty} \phi_k e^{-kx}$$

where ϕ_k are formal power series, which means

$$y = \sum_{k=0}^{\infty} e^{-kx} y_k \tag{4.43}$$

where y_k are also formal power series. Having obtained this information, it is more convenient to plug in (4.43) directly in the equation and solve for the unknown series y_k . We get the system of equations for the *power series* y_k :

$$\begin{aligned} y'_0 + y_0 &= x^{-1} + y_0^3 \\ y'_1 &= 3y_0^2 y_1 \\ &\dots \\ y'_k - ky_k - 3y_0^2 y_k &= 3y_0 \sum_{k_1+k_2=k; k_i \geq 1} y_{k_1} y_{k_2} + \sum_{k_1+k_2+k_3=k; k_i \geq 1} y_{k_1} y_{k_2} y_{k_3} \\ &\dots \end{aligned} \tag{4.44}$$

(Check that for a given k , the sums contain finitely many terms.) We can easily see by induction that this system of equations does admit a solution with y_k integer power series. Furthermore, y_1 is defined up to an arbitrary multiplicative constant, and there is no further freedom in y_k (whose equation can be solved by our usual iteration procedure, after placing the subdominant term y'_k on the right side). We note that all equations for $k \geq 1$ are *linear inhomogeneous*. The fact that high-order equations are linear is a general feature in perturbation theory.

Choosing then y_0 in such a way that $y_1^{[1]} = 1 + ax^{-1} + \dots$ we have $y_1 = Cy_1^{[1]}$. Using the special structure of the right side of the general equation in (4.44), by induction, we see that if $y_k^{[1]}$ is the solution with the choice $y_1 = y_1^{[1]}$, then the solution when $y_1 = Cy_1^{[1]}$ is $C^k y_k^{[1]}$. Thus the general formal solution of (4.29) in our setting should be

$$\sum_{k=0}^{\infty} C^k y_k^{[1]} e^{-kx}$$

where $y_0^{[1]} = y_0$.

Exercise 4.45 (*) Complete the details in the previous analysis: show that the equation for y_1 in (4.44) has a one parameter family of solutions of the form $y_1 = c(1 + s_1)$ where s_1 is a small series, and that this series is unique. Show that for $k > 1$, given y_0, \dots, y_{k-1} , the equation for y_k in (4.44) has a unique small series solution. Show that there exists exactly a one parameter family of solutions general formal exponential-power series solution of the form (4.43) of (4.29).

4.2 Transseries

4.2a Remarks about the form of asymptotic expansions

The asymptotic expansions that we have seen so far have the common feature that they are written in terms of powers of the variable, exponentials and logs, e.g.,

$$\int_x^\infty e^{-s^2} ds \sim e^{-x^2} \left(\frac{1}{2x} - \frac{1}{4x^2} + \frac{5}{8x^3} - \dots \right) \tag{4.46}$$

$$n! \sim \sqrt{2\pi} e^{n \ln n - n + \frac{1}{2} \ln n} \left(1 + \frac{1}{12n} + \dots \right) \tag{4.47}$$

$$\int_1^x \frac{e^t}{t} dt \sim e^x \left(\frac{1}{x} + \frac{1}{x^2} + \frac{2}{x^3} + \dots \right) \tag{4.48}$$

4.2b Construction of transseries: A first sketch

Transseries are studied carefully in §4.9. They are finitely generated asymptotic combinations of powers, exponentials and logs and are defined inductively. In the case of a power series, finite generation means that the series is an integer multiseries in y_1, \dots, y_n where $y_j = x^{-\beta_j}$, $\text{Re}(\beta_j) > 0$. Examples are (4.38), (3.81) and (1.26); a more involved one would be

$$\ln \ln x + \sum_{k=0}^\infty e^{-k \exp(\sum_{k=0}^\infty k! x^{-k})}$$

A single term in a transseries is a transmonomial.

1. A term of the form $m = x^{-\alpha_1 k_1 - \dots - \alpha_n k_n}$ with $\alpha_i > 0$ is a level zero **(trans)monomial**.
2. Real transseries of level zero are simply finitely generated *asymptotic* power series. That is, given $\alpha_1, \dots, \alpha_n$ with $\alpha_i > 0$, a level zero transseries is a formal sum

$$S = \sum_{k_i \geq M_i} c_{k_1, \dots, k_n} x^{-\alpha_1 k_1 - \dots - \alpha_n k_n} \tag{4.49}$$

with $c_{M_1, \dots, M_n} \neq 0$ where the integers M_1, \dots, M_n can be positive or negative; the terms of S are therefore nonincreasing in k_i and bounded above by $O(x^{-\alpha_1 M_1 - \dots - \alpha_n M_n})$.

3. $x^{-\alpha_1 M_1 - \dots - \alpha_n M_n}$ is the leading order, c_{M_1, \dots, M_n} , assumed nonzero, is the leading constant and $c_{M_1, \dots, M_n} x^{-\alpha_1 M_1 - \dots - \alpha_n M_n}$ is the dominance of (4.49), $\text{dom}(S)$.

Note. When we construct transseries carefully, in §4.9, we will denote $\mu_{\mathbf{k}} =: \mu_1^{k_1} \dots \mu_n^{k_n}$ the monomial $x^{-k_1 \alpha_1 - \dots - k_n \alpha_n}$. We note that $\mathbf{k} \mapsto \mu_{\mathbf{k}}$ defines a morphism between \mathbb{Z}^n and the Abelian multiplicative group generated by μ_1, \dots, μ_n .

4. The lower bound for k_i easily implies that there are only finitely many terms with the same monomial. Indeed, the equation $\alpha_1 k_1 + \dots + \alpha_n k_n = p$ does not have solutions if $\text{Re}(\alpha_i) k_i > |p| + \sum_{j \neq i} |\alpha_j| |M_j|$.
5. A level zero transseries can be decomposed as $L + \text{const} + s$ where L , which could be zero, is the purely large part in the sense that it contains only large monomials, and s is small.

If $S \neq 0$ we can write uniquely

$$S = \text{const} x^{-\alpha_1 M_1 - \dots - \alpha_n M_n} (1 + s)$$

where s is small.

6. Operations are defined on level zero transseries in a natural way. The product of level zero transseries is a level zero transseries where, as in 4 above, the lower bound for k_i entails that there are only finitely many terms with the same monomial in the product.
7. It is easy to see that the expression $(1 + s)^{-1} := 1 - s + s^2 + \dots$ is well defined, after rearrangement, and this allows definition of division via

$$1/S = \text{const}^{-1} x^{\alpha_1 M_1 + \dots + \alpha_n M_n} (1 + s)^{-1}$$

8. A transmonomial of order zero is small if $m = o(1)$ and large if $1/m$ is small. m is neither large nor small iff $m = 1$ which happens iff $-\alpha_1 k_1 - \dots - \alpha_n k_n = 0$; this is a degenerate case.
9. It can be checked that level zero transseries form a differential field. Composition $S_1(S_2)$ is also well defined whenever S_2 is a large transseries.

In the more abstract language of §4.9, for a given set of monomials μ_1, \dots, μ_n and the multiplicative group \mathcal{G} generated by them, a transseries of level zero is a function defined on \mathbb{Z}^n with values in \mathbb{C} , with the property that for some \mathbf{k}_0 we have $F(\mathbf{k}) = \mathbf{0}$ if $\mathbf{k} < \mathbf{k}_0$.

More general transseries are defined inductively; in a first step exponentials of purely large level zero series are level one transmonomials.

It is convenient to first construct transseries without logs and then define the general ones by composition to the right with an iterated log.

10. **Level one.** The exponential e^x has no asymptotic *power* series at infinity (Proposition 4.32) and e^x is taken to be its own expansion. It is a new element. More generally, e^L with L purely large (positive or negative) is a new element.
11. A level one transmonomial is of the form $\mu = me^L$ where m is a level zero transmonomial and L is a purely large level zero transseries. μ is *large* if the leading constant of L is positive and small otherwise. If L is large and positive then e^L is, by definition, much larger than any monomial of level zero. We define naturally $e^{L_1}e^{L_2} = e^{L_1+L_2}$. Note that in our convention both x and $-x$ are *large* transseries.
12. A level one transseries is of the form

$$S = \sum_{k_i \geq M_i} c_{k_1, \dots, k_n} \mu_1^{-k_1} \cdots \mu_n^{-k_n} := \sum_{\mathbf{k} \geq \mathbf{M}} c_{\mathbf{k}} \boldsymbol{\mu}^{\mathbf{k}} \tag{4.50}$$

where μ_i are *large* level one or zero transmonomials.

With the operations defined naturally as above, level one transseries form a differential field.

13. We define, for a *small* transseries, $e^s = \sum_{k=0}^{\infty} s^k/k!$. If s is of level zero, then e^s is of level zero too. Instead, we cannot expand e^L , where L is purely large.
14. Differentiation is defined inductively: $(x^a)' = ax^{a-1}$, and the steps to be carried by induction are $(fg)' = f'g + fg'$, $\left(\sum_{\mathbf{k} \geq \mathbf{M}} c_{\mathbf{k}} \boldsymbol{\mu}^{\mathbf{k}}\right)' = \sum c_{\mathbf{k}} (\boldsymbol{\mu}^{\mathbf{k}})'$ and $(e^L)' = L'e^L$.
15. The construction proceeds similarly, by induction, going back to 11 replacing 1 with 2, etc. A general exponential-free transseries is one obtained at *some level* of the induction. Transseries form a differential field.

16. In general, transseries have an exponential level (height) which is the highest order of composition of the exponential (and similarly a logarithmic depth) $\exp(\exp(x^2)) + \ln x$ has height 2 and depth 1. Height and depth are required to be finite. That is, for instance, the expression

$$f = e^{-x} + e^{-e^x} + e^{-e^{e^x}} + \dots \tag{4.51}$$

(as a *function series* (4.51) converges uniformly on \mathbb{R} to a C^∞ function)⁶ is not a valid transseries.

17. It can be shown, by induction, that $S' = 0$ iff $S = \text{const.}$
18. *Dominance:* If $S \neq 0$ then there is a largest transmonomial $\mu_1^{-k_1} \dots \mu_n^{-k_n}$ in S , with nonzero coefficient, C . Then $\text{dom}(S) = C\mu_1^{-k_1} \dots \mu_n^{-k_n}$. If S is a nonzero transseries, then $S = \text{dom}(S)(1 + s)$ where s is small, i.e., all the transmonomials in s are small. A base of monomials can then be chosen such that all M_i in s are positive; this is shown in §4.9.
19. Topology (convergence).

- (a) If \tilde{S} is the space of transseries generated by the monomials μ_1, \dots, μ_n then, by definition, the sequence $S^{[j]}$ converges to S given in (4.50) if for any \mathbf{k} there is a $j_0 = j_0(\mathbf{k})$ such that $c_{\mathbf{k}}^{[j]} = c_{\mathbf{k}}$ for all $j \geq j_0$. *Every* coefficient is independent of j for large enough j .
- (b) In this topology, addition and multiplication are continuous, but multiplication by scalars is not.
- (c) It is easy to check that any Cauchy sequence is convergent and transseries form a complete linear topological space.
- (d) *Contractive mappings:* Consider a space \tilde{T} of transseries closed under operations and sharing a common set T of transmonomials, and a subset \tilde{T}_1 of \tilde{T} . A function (operator) $\mathcal{A} : \tilde{T}_1 \rightarrow \tilde{T}_1$ is contractive, roughly, if the following holds. For any $S_1, S_2 \in \tilde{T}$, every monomial in $\mathcal{A}(S_1) - \mathcal{A}(S_2)$ is obtained from a monomial μ_j in $S_1 - S_2$ by multiplication of μ_j by some small transseries $s(j) \in \tilde{T}_1$. The precise definition is found in §4.9.
- (e) *Fixed point theorem.* It can be proved in the usual way that if \mathcal{A} is contractive, then the equation $S = S_0 + \mathcal{A}(S)$ has a unique fixed point.

Examples — This is a convenient way to show the existence of multiplicative inverses. It is enough to invert $1 + s$ with s small. We

⁶It turns out that the Taylor series of f has zero radius of convergence everywhere, with $|f^{(m)}|$ exceeding $e^{m \ln m \ln \ln m}$.

choose a basis such that all M_i in s are positive. Then the equation $y = 1 - sy$ is contractive.

—Differentiation is contractive on level zero transseries (multi-series). This is intuitively obvious since upon differentiation every power in a series decreases by one.

—The equation $y = 1/x - y'$ is contractive within level zero transseries; It has a unique solution.

—The inhomogeneous Airy equation

$$y = \frac{1}{x} + \frac{1}{x}y''$$

also has a unique solution, namely

$$y = \left[\sum_{k=0}^{\infty} \left(\frac{1}{x} \frac{d^2}{dx^2} \right)^k \right] \frac{1}{x} = \frac{1}{x} + \frac{2}{x^4} + \frac{40}{x^7} + \dots \tag{4.52}$$

20. If $L_n = \log(\log(\dots \log(x)))$ n times, and T is an exponential-free transseries then $T(L_n)$ is a general transseries. Transseries form a differential field, furthermore closed under integration, composition to the right with large transseries, and many other operations; this closure is proved as part of the general induction.

21. The theory of differential equations in transseries has many similarities with the usual theory. For instance it is easy to show, using an integrating factor and 17 above that the equation $y' = y$ has the general solution Ce^x and that the Airy equation $y'' = xy$ that we looked at already, has at most two linearly independent solutions. We will find two such solutions in the examples below.

Note 4.53 *Differentiation is not contractive on the space of power series at zero, or at any point $z_0 \in \mathbb{C}$, but only on asymptotic series at infinity. Note that $d/dz = d/d(1/x) = -x^2d/dx$.*

4.2c Examples of transseries solution: A nonlinear ODE

To find a formal power series solution of

$$y' + y = x^{-2} + y^3 \tag{4.54}$$

we proceed as usual, separating out the dominant terms, in this case y and x^{-2} . We get the iteration scheme

$$y_{[n]}(x) - x^{-2} = y_{[n-1]}^3 - y'_{[n-1]} \tag{4.55}$$

with $y_{[0]} = 0$. After a few iterations we get

$$\tilde{y}(x) = x^{-2} + 2x^{-3} + 6x^{-4} + 24x^{-5} + 121x^{-6} + 732x^{-7} + 5154x^{-8} + \dots \quad (4.56)$$

To find further solutions, since contractivity shows there are no further level zero transseries, we look for higher order corrections. We write $y = \tilde{y} + \delta =: y_0 + \delta$ and obtain (4.30). Since y_0 and δ are small, to leading order the equation is $\delta' + \delta = 0$. Thus $\delta = Ce^{-x}$. Including the power correction $3y_0^2\delta$, we get $\delta = Cy_1e^{-x}$ where y_1 is a power series. Clearly, to next order of approximation, we need to take into account $3y_0\delta^2$ which is roughly $3C^2y_0y_1^2e^{-2x}$. This introduces a correction of type $C^2y_2e^{-2x}$ to δ , with y_2 a power series, and continuing, we get, through the nonlinearity $\delta = \sum_{k=1}^{\infty} C^k e^{-kx} y_k$, a level one transseries. To show uniqueness we can write the equation for δ in a contractive way, which is better done within the rigorous theory of transseries (cf. [Exercise 4.230](#)). For further analysis of this transseries see [§5.3b](#).

Example 2. To find a formal solution for the Gamma function recurrence $a_{n+1} = na_n$, we look directly for transseries of level at least one, $a_n = e^{f_n}$ (since it is clear that no series in powers of $1/n$ can satisfy the recurrence). Thus $f_{n+1} = \ln n + f_n$. It is clear that $f_{n+1} - f_n \ll f_n$; this suggests writing $f_{n+1} = f_n + f'_n + \frac{1}{2}f''_n + \dots$ and, taking $f' = h$ we get the equation

$$h_n = \ln n - \frac{1}{2}h'_n - \frac{1}{6}h''_n - \dots \quad (4.57)$$

(which is contractive in the space of transseries of zero level; see also [§4.3.1](#) and [Note 4.53](#)). We get

$$h = \ln n - \frac{1}{2n} - \frac{1}{12n^2} + \frac{1}{120n^4} \dots$$

and thus

$$f_n = n \ln n - n - \frac{1}{2} \ln n + \frac{1}{12n} - \frac{1}{360n^3} \dots + C$$

4.3 Solving equations in terms of Laplace transforms

Let us now consider again the Airy equation

$$y'' = xy \quad (4.58)$$

We divide by $\exp(\frac{2}{3}x^{3/2})$ and change variable $\frac{2}{3}x^{3/2} = s$ to ensure that the transformed function has an asymptotic series with power-one of the factorial divergence. The need for that will be clarified later; see [§4.7](#).

Taking then $y(x) = e^{\frac{2}{3}x^{3/2}} h(\frac{2}{3}x^{3/2})$ we get

$$h'' + \left(2 + \frac{1}{3s}\right)h' + \frac{1}{3s}h = 0 \quad (4.59)$$

and with $H = \mathcal{L}^{-1}(h)$ we get

$$p(p-2)H' = \frac{5}{3}(1-p)H$$

The solution is

$$H = Cp^{-5/6}(2-p)^{-5/6}$$

and it can be easily checked that any integral of the form

$$h = \int_0^{\infty e^{i\phi}} e^{-ps} H(p) dp$$

for $\phi \neq 0$ and $\text{Re}(ps) > 0$, is a solution of (4.59) yielding the expression

$$f = e^{\frac{2}{3}x^{3/2}} \int_0^{\infty e^{i\phi}} e^{-\frac{2}{3}x^{3/2}p} p^{-5/6} (2-p)^{-5/6} dp \quad (4.60)$$

for a solution of the Airy equation. A second solution can be obtained in a similar way, replacing $e^{\frac{2}{3}x^{3/2}}$ by $e^{-\frac{2}{3}x^{3/2}}$, or by taking the difference between two integrals of the form (4.60). Note what we did here is *not* Laplace's method of solving linear ODEs. Examine the differences.

For Example 2, p. 97, factorial divergence suggests taking inverse Laplace transform of $g_n = f_n - (n \ln n - n - \frac{1}{2} \ln n)$.

The recurrence satisfied by g is

$$g_{n+1} - g_n = q_n = 1 - \left(\frac{1}{2} + n\right) \ln \left(1 + \frac{1}{n}\right) = -\frac{1}{12n^2} + \frac{1}{12n^3} + \dots$$

First note that $\mathcal{L}^{-1}q = p^{-2}\mathcal{L}^{-1}q''$ which can be easily evaluated by residues since

$$q'' = \frac{1}{n} - \frac{1}{n+1} - \frac{1}{2} \left(\frac{1}{(n+1)^2} + \frac{1}{n^2} \right)$$

Thus, with $\mathcal{L}^{-1}g_n := G$ we get

$$(e^{-p} - 1)G(p) = \frac{1 - \frac{p}{2} - \left(\frac{p}{2} + 1\right)e^{-p}}{p^2}$$

$$g_n = \int_0^{\infty} \frac{1 - \frac{p}{2} - \left(\frac{p}{2} + 1\right)e^{-p}}{p^2(e^{-p} - 1)} e^{-np} dp$$

(It is easy to check that the integrand is analytic at zero; its Taylor series is $\frac{1}{12} - \frac{1}{720}p^2 + O(p^3)$.)

The integral is well defined, and it easily follows that

$$f_n = C + n(\ln n - 1) - \frac{1}{2} \ln n + \int_0^\infty \frac{1 - \frac{p}{2} - \left(\frac{p}{2} + 1\right)e^{-p}}{p^2(e^{-p} - 1)} e^{-np} dp$$

solves our recurrence. The constant $C = \frac{1}{2} \ln(2\pi)$ is most easily obtained by comparing with Stirling's formula (3.153) and we thus get the identity

$$\ln \Gamma(n+1) = n(\ln n - 1) - \frac{1}{2} \ln n + \frac{1}{2} \ln(2\pi) + \int_0^\infty \frac{1 - \frac{p}{2} - \left(\frac{p}{2} + 1\right)e^{-p}}{p^2(e^{-p} - 1)} e^{-np} dp \tag{4.61}$$

which holds with n replaced by $z \in \mathbb{C}$ as well.

This represents, as it will be clear from the definitions, the Borel summed version of Stirling's formula.

Exercise 4.62 (*) Prove formula (1.2); find a bound for C when $|z| < 1/2$.

Other recurrences can be dealt with in the same way. One can calculate $\sum_{j=1}^n j^{-1}$ as a solution of the recurrence

$$s_{n+1} - s_n = \frac{1}{n}$$

Proceeding as in the Gamma function example, we have $f' - \frac{1}{n} = O(n^{-2})$ and the substitution $s_n = \ln n + g_n$ yields

$$g_{n+1} - g_n = \frac{1}{n} + \ln\left(\frac{n}{n+1}\right)$$

and in the same way we get

$$f_n = C + \ln n + \int_0^\infty e^{-np} \left(\frac{1}{p} - \frac{1}{1 - e^{-p}}\right) dp$$

where the constant can be obtained from the initial condition, $f_1 = 0$,

$$C = - \int_0^\infty e^{-p} \left(\frac{1}{p} - \frac{1}{1 - e^{-p}}\right) dp$$

which, by comparison with the usual asymptotic expansion of the harmonic sum also gives an integral representation for the Euler constant,

$$\gamma = \int_0^\infty e^{-p} \left(\frac{1}{1 - e^{-p}} - \frac{1}{p}\right) dp$$

Comparison with (4.61) gives

$$\sum_{j=1}^{n-1} \frac{1}{j} - \gamma = \ln n + \int_0^\infty e^{-np} \left(\frac{1}{p} - \frac{1}{1 - e^{-p}} \right) dp = \frac{\Gamma'(n)}{\Gamma(n)} \tag{4.63}$$

Exercise: The Zeta function. Use the same strategy to show that

$$(n - 1)! \zeta(n) = \int_0^\infty p^{n-1} \frac{e^{-p}}{1 - e^{-p}} dp = \int_0^1 \frac{\ln^{n-1} s}{1 - s} ds \tag{4.64}$$

4.3.1 The Euler-Maclaurin summation formula

Assume $f(n)$ does not increase too rapidly with n and we want to find the asymptotic behavior of

$$S(n + 1) = \sum_{k=k_0}^n f(k) \tag{4.65}$$

for large n . We see that $S(k)$ is the solution of the difference equation

$$S(k + 1) - S(k) = f(k) \tag{4.66}$$

To be more precise, assume f has a level zero transseries as $n \rightarrow \infty$. Then we write \tilde{S} for the transseries of S which we seek at level zero. Then $\tilde{S}(k + 1) - \tilde{S}(k) = \tilde{S}'(k) + \tilde{S}''(k)/2 + \dots + \tilde{S}^{(n)}(k)/k! + \dots = \tilde{S}' + L\tilde{S}$ where

$$L = \sum_{k=2}^\infty \frac{1}{j!} \frac{d^j}{dk^j} \tag{4.67}$$

is contractive on \mathcal{T}_0 (check) and thus

$$\tilde{S}'(k) = f(k) - L\tilde{S} \tag{4.68}$$

has a unique solution,

$$\tilde{S}' = \sum_{j=0}^\infty (-1)^j L^j f =: \frac{1}{1 + L} f \tag{4.69}$$

(check that there are no transseries solutions of higher level). From the first few terms, or using successive approximations, that is writing $S' = g$ and

$$g_{l+1} = f - \frac{1}{2}g'_l - \frac{1}{6}g''_l - \dots \tag{4.70}$$

we get

$$\tilde{S}'(k) = f(k) - \frac{1}{2}f'(k) + \frac{1}{12}f''(k) - \frac{1}{720}f^{(4)}(k) + \dots = \sum_{j=0}^\infty C_j f^{(j)}(k) \tag{4.71}$$

We note that to get the coefficient of $f^{(n)}$ correctly, using iteration, we need to keep correspondingly many terms on the right side of (4.70) and iterate $n + 1$ times.

In this case, we can find the coefficients explicitly. Indeed, examining the way the C_j s are obtained, it is clear that they do not depend on f . Then it suffices to look at some particular f for which the sum can be calculated explicitly; for instance $f(k) = e^{k/n}$ summed from 0 to n . By one of the definitions of the Bernoulli numbers we have

$$\frac{z}{1 - e^{-z}} = \sum_{k=0}^{\infty} (-1)^j \frac{B_j}{j!} z^j \tag{4.72}$$

Exercise 4.73 Using these identities, determine the coefficients C_j in (4.71).

Using Exercise 4.73 we get

$$S(k) \sim \int_{k_0}^k f(s)ds + C + \sum_{j=1}^{\infty} \frac{B_{2j}}{2j!} f^{(2j-1)}(k) \tag{4.74}$$

Rel. (4.74) is called the Euler-Maclaurin sum formula.

Exercise 4.75 (*) Complete the details of the calculation involving the identification of coefficients in the Euler-Maclaurin sum formula.

Exercise 4.76 Find for which values of $a > 0$ the series

$$\sum_{k=1}^{\infty} \frac{e^{i\sqrt{k}}}{k^a}$$

is convergent.

Exercise 4.77 (*) Prove the Euler-Maclaurin sum formula in the case f is C^∞ by first looking at the integral $\int_n^{n+1} f(s)ds$ and expanding f in Taylor at $s = n$. Then correct f to get a better approximation, etc.

That (4.74) gives the correct asymptotic behavior in fairly wide generality is proved, for example, in [20].

We will prove here, under stronger assumptions, a stronger result which implies (4.74). The conditions are often met in applications, after changes of variables, as our examples showed.

Lemma 4.78 Assume f has a Borel summable expansion at 0^+ (in applications f is often analytic at 0) and $f(z) = O(z^2)$. Then $f(\frac{1}{n}) = \int_0^\infty F(p)e^{-np}dp$, $F(p) = O(p)$ for small p and

$$\sum_{k=n_0}^{n-1} f(1/n) = \int_0^\infty e^{-np} \frac{F(p)}{e^{-p} - 1} dp - \int_0^\infty e^{-n_0p} \frac{F(p)}{e^{-p} - 1} dp \tag{4.79}$$

PROOF We seek a solution of (4.66) in the form $S = C + \int_0^\infty H(p)e^{-kp} dp$, or, in other words we inverse Laplace transform the equation (4.66). We get

$$(e^{-p} - 1)H = F \Rightarrow H(p) = \frac{F(p)}{e^{-p} - 1} \tag{4.80}$$

and the conclusion follows by taking the Laplace transform which is well defined since $F(p) = O(p)$, and imposing the initial condition $S(k_0) = 0$. \square

For a general analysis of the summability properties of the Euler-Maclaurin formula see [27].

4.3a A second order ODE: The Painlevé equation P_I

$$\frac{d^2y}{dx^2} = 6y^2 + x \tag{4.81}$$

We first look for formal solutions. As a transseries of level zero, it is easy to see that the only possible balance is $6y^2 + x = 0$ giving

$$y \sim \pm \frac{i}{\sqrt{6}}\sqrt{x}$$

We choose one of the signs, say + and write

$$\tilde{y}_0 = \frac{i}{\sqrt{6}}\sqrt{x - \tilde{y}_0''} = \frac{i}{\sqrt{6}}\left(\sqrt{x} - \frac{\tilde{y}_0''}{2\sqrt{x}} - \frac{1}{8x^{3/2}}(\tilde{y}_0'')^2 \dots\right) \tag{4.82}$$

By iteration we get

$$\tilde{y}_0 = \frac{i}{\sqrt{6}}\left(\sqrt{x} + \frac{i\sqrt{6}}{48x^2} + \frac{49i}{768x^{9/2}} \dots\right) \tag{4.83}$$

To find the solution as a Laplace transform of a function with a convergent series at the origin, we need to ensure that the formal series is Gevrey one; see §4.5 and §4.7. The growth of the coefficients of the x series can be estimated from their recurrence, but there are better ways to proceed, for instance using the duality with the type of possible small exponential corrections. The reason behind this duality will be explained in §4.7.

Exercise 4.84 Let $\tilde{y} = \tilde{y}_0 + \delta$ be a transseries solution to (4.82). Show (for instance by WKB) that $\ln \delta = \frac{4}{5}\sqrt{2}i6^{1/4}x^{5/4}(1 + o(1))$.

Equivalently, still heuristically for the moment, we note that the series is obtained, by and large, by repeated iteration of $d^2/(\sqrt{x}dx^2)$. This applied to power series, and insofar as the ensuing divergence of coefficients is concerned,

is equivalent to repeated iteration of $d/(x^{1/4}dx) \sim d/dx^{5/4}$. Iteration of d/dt on analytic nonentire functions produces Gevrey-one series (§4.5), and thus the natural variable is $t = x^{5/4}$. This variable appears, as mentioned before, in the exponential corrections; see [Exercise 4.84](#). We let

$$t = \frac{(-24x)^{5/4}}{30}; \quad y(x) = \sqrt{\frac{-x}{6}} \left(1 - \frac{4}{25t^2} + h(t) \right)$$

P_I becomes

$$h'' + \frac{1}{t}h' - h - \frac{1}{2}h^2 - \frac{392}{625t^4} = 0 \tag{4.85}$$

If we write $h(t) = \int_0^\infty H(p)e^{-tp}dp$, then the equation for H is

$$(p^2 - 1)H(p) = \frac{196}{1875}p^3 + \int_0^p sH(s)ds + \frac{1}{2}H * H \tag{4.86}$$

where convolution is defined by (2.21). We will solve convolution equations of the form (4.86) on an example in §5.3a and in general in §5.

4.4 Borel transform, Borel summation

The formal Laplace transform, $\tilde{\mathcal{L}} : \mathbb{C}[[p]] \mapsto \mathbb{C}[[x^{-1}]]$ is defined by

$$\tilde{\mathcal{L}} \left\{ \sum_{k=0}^\infty c_k p^k \right\} = \sum_{k=0}^\infty c_k \tilde{\mathcal{L}}\{p^k\} = \sum_{k=0}^\infty c_k k! x^{-k-1} \tag{4.87}$$

(with $\tilde{\mathcal{L}}\{p^{\alpha-1}\} = \Gamma(\alpha)x^{-\alpha}$ the definition extends straightforwardly to noninteger power series).

4.4a The Borel transform \mathcal{B}

The **Borel transform**, $\mathcal{B} : \mathbb{C}[[x^{-1}]] \mapsto \mathbb{C}[[p]]$ is the (formal) inverse of the operator \mathcal{L} in (4.87). This is a transform on the space of formal series. By definition, for a monomial we have

$$\mathcal{B} \frac{\Gamma(s+1)}{x^{s+1}} = p^s \tag{4.88}$$

in \mathbb{C} (more precisely, on the universal covering of $\mathbb{C} \setminus \{0\}$; see [footnote](#) on p. 219) to be compared with the inverse Laplace transform,

$$\mathcal{L}^{-1} \frac{\Gamma(s+1)}{x^{s+1}} = \begin{cases} p^s & \text{for } \operatorname{Re} p > 0 \\ 0 & \text{otherwise} \end{cases} \tag{4.89}$$

(for $\text{Re}(p) \leq 0$ the contour in (2.14) can be pushed to $+\infty$).

Because the k -th coefficient of $\mathcal{B}\{\tilde{f}\}$ is smaller by a factor $k!$ than the corresponding coefficient of \tilde{f} , $\mathcal{B}\{\tilde{f}\}$ may converge even if \tilde{f} does not. Note that $\tilde{\mathcal{L}}\mathcal{B}$ is the identity operator, on series. If $\mathcal{B}\{\tilde{f}\}$ is convergent and \mathcal{L} is the actual Laplace transforms, we effectively get an identity-like operator from Gevrey-one series to functions.

These two facts account for the central role played by $\mathcal{L}\mathcal{B}$, the operator of Borel summation in the theory of analyzable functions. See also the diagram on p. 17.

4.4b Definition of Borel summation and basic properties

Series of the form $\tilde{f} = \sum_{k=0}^{\infty} c_k x^{-\beta_1 k_1 - \dots - \beta_m k_m - r}$ with $\text{Re}(\beta_j) > 0$ frequently arise as formal solutions of differential systems. We will first analyze the case $m = 1, r = 1, \beta = 1$ but the theory extends without difficulty to more general series.

Borel summation is relative to a direction; see Definition 4.111. The same formal series \tilde{f} may yield different functions by Borel summation in different directions.

Borel summation along \mathbb{R}^+ consists of three operations, assuming (2) and (3) are possible:

1. Borel transform, $\tilde{f} \mapsto \mathcal{B}\{\tilde{f}\}$.
2. Convergent summation of the series $\mathcal{B}\{\tilde{f}\}$ and analytic continuation along \mathbb{R}^+ (denote the continuation by F and by \mathcal{D} an open set in \mathbb{C} containing $\mathbb{R}^+ \cup \{0\}$ where F is analytic).
3. Laplace transform, $F \mapsto \int_0^{\infty} F(p)e^{-px} dp =: \mathcal{L}\mathcal{B}\{\tilde{f}\}$, which requires exponential bounds on F , defined in some half-plane $\text{Re}(x) > x_0$.

Note 4.90 Slightly more generally, the formal inverse Laplace transform (Borel transform, \mathcal{B}) of a small zero level transseries, that is of a small multi-series, is defined, roughly, as the *formal multiseris* obtained by term-by-term inverse Laplace transform,

$$\mathcal{B} \sum_{\mathbf{k}>0} c_{\mathbf{k}} x^{-\mathbf{k} \cdot \mathbf{a}} = \sum_{\mathbf{k}>0} c_{\mathbf{k}} p^{\mathbf{k} \cdot \mathbf{a} - 1} / \Gamma(\mathbf{k} \cdot \mathbf{a}) \tag{4.91}$$

The definition of Borel summation for multiseris as in (4.91) is the same, replacing analyticity at zero with ramified analyticity.

*

The *domain* of Borel summation is the subspace $S_{\mathcal{B}}$ of series for which the conditions for the steps above are met. For step 3 we can require that for some constants C_F, ν_F we have $|F(p)| \leq C_F e^{\nu_F p}$. Or we can require that $\|F\|_{\nu} < \infty$ where, for $\nu > 0$ we define

$$\|F\|_{\nu} := \int_0^{\infty} e^{-\nu p} |F(p)| dp \tag{4.92}$$

Remark 4.93 *The results above can be rephrased for more general series of the form $\sum_{k=0}^{\infty} c_k x^{-k-r}$ by noting that for $\text{Re}(\rho) > -1$ we have*

$$\mathcal{L}p^\rho = x^{-\rho-1}\Gamma(\rho + 1)$$

and thus

$$\mathcal{B}\left(\sum_{k=0}^{\infty} c_k x^{-k-r}\right) = c_0 \frac{p^{r-1}}{\Gamma(r)} + \frac{p^{r-1}}{\Gamma(r)} * \mathcal{B}\left(\sum_{k=1}^{\infty} c_k x^{-k}\right)$$

Furthermore, Borel summation naturally extends to series of the form

$$\sum_{k=-M}^{\infty} c_k x^{-k-r}$$

where $M - 1 \in \mathbb{N}$ by defining

$$\mathcal{LB}\left(\sum_{k=-M}^{\infty} c_k x^{-k-r}\right) = \sum_{k=-M}^{-1} c_k x^{-k-r} + \mathcal{LB}\left(\sum_{k=0}^{\infty} c_k x^{-k-r}\right)$$

More general powers can be allowed, replacing analyticity in p with analyticity in $p^{\beta_1}, \dots, p^{\beta_m}$.

Simple examples of Borel summed series are series that indeed come from the Laplace transform of analytic functions, as in (4.61), (4.63), (4.113) and (4.128).

We note that $L_\nu^1 := \{f : \|f\|_\nu < \infty\}$ forms a Banach space, and it is easy to check that

$$L_\nu^1 \subset L_{\nu'}^1, \text{ if } \nu' > \nu \tag{4.94}$$

and that

$$\|F\|_\nu \rightarrow 0 \text{ as } \nu \rightarrow \infty \tag{4.95}$$

the latter statement following from dominated convergence.

Note 4.96 A function f is sometimes called Borel summable (by slight abuse of language), if it is analytic and suitably decaying in a half-plane (say \mathbb{H}), and its inverse Laplace transform F is analytic in a neighborhood of $\mathbb{R}^+ \cup \{0\}$. Such functions are clearly into a one-to-one correspondence with their asymptotic series. Indeed, if the asymptotic series coincide, then their Borel transforms — which are convergent series — coincide, and their analytic continuation is the same in a neighborhood of $\mathbb{R}^+ \cup \{0\}$. The two functions are equal.

4.4b.1 Note on exponentially small corrections

Note 4.96 shows that we can define corrections to divergent expansions, within the realm of Borel summable series. For instance we can represent f by \tilde{f} (a power series) plus Ce^{-x} , iff $f - Ce^{-x}$ is Borel summable.

4.4c Further properties of Borel summation

Proposition 4.97 (i) $S_{\mathcal{B}}$ is a differential field⁷, and $\mathcal{LB} : S_{\mathcal{B}} \mapsto \mathcal{LBS}_{\mathcal{B}}$ commutes with differential field operations, that is, \mathcal{LB} is a differential algebra isomorphism.

(ii) If $S_c \subset S_{\mathcal{B}}$ denotes the differential algebra of convergent power series, and we identify a convergent power series with its sum, then \mathcal{LB} is the identity on S_c .

(iii) In addition, for $\tilde{f} \in S_{\mathcal{B}}$, $\mathcal{LB}\{\tilde{f}\} \sim \tilde{f}$ as $|x| \rightarrow \infty$, $\text{Re}(x) > 0$.

For the proof, we need to look more closely at convolutions.

Definition 4.98 (Inverse Laplace space convolution) If $F, G \in L^1_{loc}$ then

$$(F * G)(p) := \int_0^p F(s)G(p - s)ds \tag{4.99}$$

Assuming exponential bounds at infinity we have (cf (2.20))

$$\mathcal{L}(F * G) = \mathcal{L}F \mathcal{L}G \tag{4.100}$$

Lemma 4.101 The space of functions which are in $L^1[0, \epsilon]$ for some $\epsilon > 0$ and real-analytic on $(0, \infty)$ is closed under convolution. If F and G are exponentially bounded, then so is $F * G$. If $F, G \in L^1_{\nu}$, then $F * G \in L^1_{\nu}$.

PROOF The statement about L^1 follows easily from Fubini’s theorem. Writing

$$\int_0^p f_1(s)f_2(p - s)ds = p \int_0^1 f_1(pt)f_2(p(1 - t))dt \tag{4.102}$$

analyticity is manifest. Clearly, if $|F_1| \leq C_1e^{\nu_1 p}$ and $|F_2| \leq C_2e^{\nu_2 p}$, then

$$|F_1 * F_2| \leq C_1C_2p e^{(\nu_1 + \nu_2)p} \leq C_1C_2 e^{(\nu_1 + \nu_2 + 1)p}$$

Finally, we note that

$$\begin{aligned} \int_0^{\infty} e^{-\nu p} \left| \int_0^p F(s)G(p - s)ds \right| dp &\leq \int_0^{\infty} e^{-\nu s} e^{-\nu(p-s)} \int_0^p |F(s)||G(p-s)| ds dp \\ &= \int_0^{\infty} \int_0^{\infty} e^{-\nu s} |F(s)| e^{-\nu \tau} |G(\tau)| d\tau = \|F\|_{\nu} \|G\|_{\nu} \end{aligned} \tag{4.103}$$

by Fubini. □

⁷with respect to formal addition, multiplication, and differentiation of power series.

To show multiplicativity, we use §4.7b. Analyticity and exponential bounds of $|F * G|$ follow from Lemma 4.101. Consequently, $F * G$ is Laplace transformable, and the result follows from (4.100).

PROOF of Proposition 4.97 We have to show that if \tilde{f} is a Borel summable series, then so is $1/\tilde{f}$. We have $f = Cx^m(1 + s)$ for some m where s is a small series.

We want to show that

$$1 - s + s^2 - s^3 + \dots \tag{4.104}$$

is Borel summable, or that

$$s_1 = -s + s^2 - s^3 + \dots \tag{4.105}$$

is Borel summable. Let $\mathcal{B}s = H$. We examine $\mathcal{B}s_1$, or, in fact the function series

$$S = -H + H * H - H^{*3} + \dots \tag{4.106}$$

where H^{*n} is the self-convolution of H n times. Each term of the series is analytic, by Lemma 4.101. Let K be an arbitrary compact subset of \mathcal{D} . If $\max_{p \in K} |H(p)| = m$, then it is easy to see that

$$|H^{*n}| \leq m^n 1^{*n} = m^n \frac{p^{n-1}}{(n-1)!} \tag{4.107}$$

Thus the function series in (4.106) is absolutely and uniformly convergent in K and the limit is analytic. Let now ν be large enough so that $\|H\|_\nu < 1$ (see (4.95)). Then the series in (4.106) is norm convergent, thus an element of L_ν^1 .

Exercise 4.108 Check that $(1 + \mathcal{L}H)(1 + \mathcal{L}S) = 1$.

It remains to show that the asymptotic expansion of $\mathcal{L}(F * G)$ is indeed the product of the asymptotic series of $\mathcal{L}F$ and $\mathcal{L}G$. This is, up to a change of variable, a consequence of Lemma 1.33.

(ii) Since $\tilde{f}_1 = \tilde{f} = \sum_{k=0}^\infty c_k x^{-k-1}$ is convergent, then $|c_k| \leq CR^k$ for some C, R and $F(p) = \sum_{k=0}^\infty c_k p^k / k!$ is entire, $|F(p)| \leq \sum_{k=0}^\infty CR^k p^k / k! = Ce^{Rp}$ and thus F is Laplace transformable for $|x| > R$. By dominated convergence we have for $|x| > R$,

$$\mathcal{L}\left\{\sum_{k=0}^\infty c_k p^k / k!\right\} = \lim_{N \rightarrow \infty} \mathcal{L}\left\{\sum_{k=0}^N c_k p^k / k!\right\} = \sum_{k=0}^\infty c_k x^{-k-1} = f(x)$$

(iii) This part follows simply from Watson’s lemma, cf. §3.4. □

4.4c.1 Convergent series composed with Borel summable series

Proposition 4.109 *Assume A is an analytic function in the disk of radius ρ centered at the origin, $a_k = A^{(k)}(0)/k!$, and $\tilde{s} = \sum s_k x^{-k}$ is a small series which is Borel summable along \mathbb{R}^+ . Then the formal power series obtained by reexpanding*

$$\sum a_k s^k$$

in powers of x is Borel summable along \mathbb{R}^+ .

PROOF Let $S = \mathcal{B}s$ and choose ν to be large enough so that $\|S\|_\nu < \rho^{-1}$ in L^1_ν . Then

$$\|F\|_\nu := \|A(*S)\|_\nu := \left\| \sum_{k=0}^\infty a_k S^{*k} \right\|_\nu \leq \sum_{k=0}^\infty a_k \|S\|_\nu^k \leq \sum_{k=0}^\infty a_k \rho^k < \infty \quad (4.110)$$

thus $A(*S) \in L^1_\nu$. Similarly, $A(*S)$ is in $L^1_\nu([0, a])$ and in $\mathcal{A}_{K,\nu}([0, a])$ (see (4) on p. 146) for any a . □

4.4c.2 Directionality of Borel sums

In general, a Laplace transform depends on the direction of the ray.

Definition 4.111 *The Borel sum of a series in the direction ϕ ($\arg x = \phi$), $(\mathcal{LB})_\phi \tilde{f}$ is by convention, the Laplace transform of $\mathcal{B}\tilde{f}$ along the ray $xp \in \mathbb{R}^+$, that is $\arg(p) = -\phi$:*

$$(\mathcal{LB})_\phi \tilde{f} = \int_0^\infty e^{-i\phi p} e^{-px} F(p) dp = \mathcal{L}_{-\phi} F = \mathcal{L}F(\cdot e^{-i\phi}) \quad (4.112)$$

We can also say that Borel summation of \tilde{f} along the ray $\arg(x) = \phi$ is defined as the (\mathbb{R}^+) Borel summation of $\tilde{f}(xe^{i\phi})$, $x \in \mathbb{R}^+$.

For example, we have

$$\mathcal{LB}_\phi \sum_{k=0}^\infty \frac{k!}{x^{k+1}} = \mathcal{L}_{-\phi} \{(1-p)^{-1}\} = \begin{cases} e^{-x}(\text{Ei}(x) - \pi i) & \text{for } \phi \in (-\pi, 0) \\ e^{-x}\text{Ei}(x) & \text{for } \phi = 0 \\ e^{-x}(\text{Ei}(x) + \pi i) & \text{for } \phi \in (0, \pi) \end{cases} \quad (4.113)$$

The middle formula does not follow by Borel summation, but rather by BE summation and uses an elementary instance of medianization. See also the discussion in §4.4f. Medianization will be considered in higher generality in §5, and it reduces in this simple case to taking the Cauchy principal part of the integral along \mathbb{R}^+ .

4.4d Stokes phenomena and Laplace transforms: An example

The change in behavior of a Borel summed series as the direction in \mathbb{C} changes is conveniently determined by suitably changing the contour of integration of the Laplace transform. We illustrate this on a simple case:

$$f(x) := \int_0^\infty \frac{e^{-px}}{1+p} dp \tag{4.114}$$

We seek to find the asymptotic behavior of the analytic continuation of f for large x , along different directions in \mathbb{C} . A simple estimate along a large arc of circle shows that, for $x \in \mathbb{R}^+$ we also have

$$f(x) = \int_0^{\infty e^{-i\pi/4}} \frac{e^{-px}}{1+p} dp \tag{4.115}$$

Then the functions given in (4.114) and (4.115) agree in \mathbb{R}^+ thus they agree everywhere they are analytic. Furthermore, the expression (4.115) is analytic for $\arg x \in (-\pi/4, 3\pi/4)$ and by the very definition of analytic continuation f admits analytic continuation in a sector $\arg(x) \in (-\pi/2, 3\pi/4)$. Now we take x with $\arg x = \pi/4$ and note that along this ray, by the same argument as before, the integral equals

$$f(x) = \int_0^{\infty e^{-\pi i/2}} \frac{e^{-px}}{1+p} dp \tag{4.116}$$

We can continue this rotation process until $\arg(x) = \pi - \epsilon$ where we have

$$f(x) = \int_0^{\infty e^{-\pi i + i\epsilon}} \frac{e^{-px}}{1+p} dp \tag{4.117}$$

which is now manifestly analytic for $\arg(x) \in (\pi/2 - \epsilon, 3\pi/2 - \epsilon)$. To proceed further, we collect the residue at the pole:

$$\int_0^{\infty e^{-\pi i - i\epsilon}} \frac{e^{-px}}{1+p} dp - \int_0^{\infty e^{-\pi i + i\epsilon}} \frac{e^{-px}}{1+p} dp = 2\pi i e^x \tag{4.118}$$

and thus

$$f(x) = \int_0^{\infty e^{-\pi i - i\epsilon}} \frac{e^{-px}}{1+p} dp - 2\pi i e^x \tag{4.119}$$

which is manifestly analytic for $\arg(x) \in (\pi/2 + \epsilon, 3\pi/2 + \epsilon)$. We can now freely proceed with the analytic continuation in similar steps until $\arg(x) = 2\pi$ and get

$$f(xe^{2\pi i}) = f(x) - 2\pi i e^x \tag{4.120}$$

The function has *nontrivial monodromy*⁸ at infinity.

We also note that by Watson's lemma, as long as f is simply equal to a Laplace transform, f has an asymptotic series in a full half-plane. Relation (4.119) shows that this ceases to be the case when $\arg(x) = \pi$. This direction is called a **Stokes ray**. The exponential that is "born" there is smaller than the terms of the series until $\arg(x) = 3\pi/2$.

In solutions to nonlinear problems, most often infinitely many exponentials are born on Stokes rays.

Returning to our example, at $\arg(x) = 3\pi/2$ the exponential becomes the dominant term of the expansion. This latter direction is called an **antistokes ray**. In solutions to nonlinear problems, all exponentials collected at a Stokes ray become large at the same time, and this is usually a source of singularities of the represented function; see §4.4e. Sometimes, the Stokes phenomenon designates, more generally, the change in the asymptotic expansion of a function when the direction towards the singular point is changed, especially if it manifests itself by the appearance of oscillatory exponentials at antistokes lines.

In the example above, it so happens that the function itself is not single-valued. Taking first $x \in \mathbb{R}^+$, we write

$$\begin{aligned} f(x) &= e^{-x} \int_1^\infty \frac{e^{-xt}}{t} dt = e^{-x} \int_x^\infty \frac{e^{-s}}{s} ds = e^{-x} \left(\int_x^1 \frac{e^{-s}}{s} ds + \int_1^\infty \frac{e^{-s}}{s} ds \right) \\ &= e^{-x} \left(C_1 + \int_x^1 \frac{e^{-s}}{s} ds \right) = e^{-x} \left(C_1 + \int_x^1 \frac{e^{-s} - 1}{s} ds - \ln x \right) \\ &= e^{-x} (\text{entire} - \ln x) \quad (4.121) \end{aligned}$$

However, the Stokes phenomenon is *not* due to the multivaluedness of the function but rather to the divergence of the asymptotic series, as seen from the following remark.

Remark 4.122 *Assume f is analytic outside a compact set and is asymptotic to \tilde{f} as $|x| \rightarrow \infty$ (in any direction). Then \tilde{f} is convergent.*

PROOF By the change of variable $x = 1/z$ we move the analysis at zero. The existence of an asymptotic series as $z \rightarrow 0$ implies in particular that f is bounded at zero. Since f is analytic in $\mathbb{C} \setminus \{0\}$, then zero is a removable singularity of f , and thus the asymptotic series, which as we know is unique, must coincide with the Taylor series of f at zero, a convergent series. \square

The exercise below also shows that the Stokes phenomenon is not due to multivaluedness.

⁸Change in behavior along a closed curve containing a singularity.

Exercise 4.123 (*) (1) Show that the function $f(x) = \int_x^\infty e^{-s^2} ds$ is entire.
 (2) Note that

$$\int_x^\infty e^{-s^2} ds = \frac{1}{2} \int_{x^2}^\infty \frac{e^{-t}}{\sqrt{t}} dt = \frac{x}{2} \int_1^\infty \frac{e^{-x^2 u}}{\sqrt{u}} du = \frac{x e^{-x^2}}{2} \int_0^\infty \frac{e^{-x^2 p}}{\sqrt{1+p}} dp \tag{4.124}$$

Do a similar analysis to the one in the text and identify the Stokes and anti-stokes rays for f . Note that the “natural variable” now is x^2 .

See (6.1) for the form of the Stokes phenomenon for generic linear ODEs.

4.4e Nonlinear Stokes phenomena and formation of singularities

Let us now look at (4.61). If we take n to be a complex variable, then the Stokes rays are those for which after deformation of contour of the integral

$$\int_0^\infty \frac{1 - \frac{p}{2} - \left(\frac{p}{2} + 1\right)e^{-p}}{p^2(e^{-p} - 1)} e^{-np} dp \tag{4.125}$$

in (4.61), which is manifestly a Borel sum of a series, will run into singularities of the denominator. This happens when n is purely imaginary. Take first n on the ray $\arg n = -\pi/2 + \epsilon$. We let

$$F(p) = \frac{1 - \frac{p}{2} - \left(\frac{p}{2} + 1\right)e^{-p}}{p^2(e^{-p} - 1)}$$

We rotate the contour of integration to $\arg p = \pi/2 - \epsilon$, compare with the integral to the left of the imaginary line and get the representation

$$\begin{aligned} \int_0^\infty e^{i\pi/2-i\epsilon} F(p)e^{-np} dp &= \int_0^\infty e^{i\pi/2+i\epsilon} F(p)e^{-np} dp \\ &+ 2\pi i \sum_{j=1}^\infty \text{Res} F(p)e^{-np} |_{p=2j\pi i} + \sum_{j=1}^\infty \frac{1}{j e^{2nj\pi i}} \\ &= \int_0^\infty e^{i\pi/2+i\epsilon} F(p)e^{-np} dp - \ln(1 - \exp(-2n\pi i)) \end{aligned} \tag{4.126}$$

where the sum is convergent when $\arg n = -\pi/2 + \epsilon$, and thus, when $\arg n = -\pi/2 + \epsilon$ we can also write

$$\Gamma(n + 1) = \frac{1}{1 - \exp(-2n\pi i)} \sqrt{2\pi n} \left(\frac{n}{e}\right)^n \exp\left(\int_0^\infty e^{i\pi/2+i\epsilon} F(p)e^{-np} dp\right) \tag{4.127}$$

from which it is manifest that for $\arg x \neq \pi$ $\Gamma(x + 1)$ is analytic and Stirling’s formula holds for large $|x|$, while along \mathbb{R}^- it is meromorphic, with simple poles at all negative integers.

We see that for $\arg(n) \in (-\pi, -\pi/2)$ the exponential, present in the Borel summed formula, is *beyond all orders*, and would not participate in any classical asymptotic expansion of $\Gamma(n + 1)$.

We also see that the poles occur on the antistokes line of Γ , and essentially as soon as exponential corrections are *classically* visible, they produce singularities. This is typical indeed when there are infinitely many singularities in Borel space, generically the case for nonlinear ODEs that we will study in §6. This is also the case in difference equations. We also note that, after reexpansion of the log, the middle expression in (4.126) is a Borel summed series plus a *transseries* in n (although now we allow n to be complex).

Conversely then, \tilde{f} Borel sums to

$$\mathcal{LB}\tilde{f} = \begin{cases} \ln \Gamma(n + 1) - \ln \left[\sqrt{2\pi n} \left(\frac{n}{e}\right)^n \right] & \arg(n) \in (-\pi/2, \pi/2) \\ \ln \Gamma(n + 1) - \ln \left[\sqrt{2\pi n} \left(\frac{n}{e}\right)^n \right] - \ln(1 - e^{-2n\pi i}) & \arg n \in \left(-\pi, -\frac{\pi}{2}\right) \\ \ln \Gamma(n + 1) - \ln \left[\sqrt{2\pi n} \left(\frac{n}{e}\right)^n \right] - \ln(1 - e^{2n\pi i}) & \arg n \in \left(\frac{\pi}{2}, \pi\right) \end{cases} \tag{4.128}$$

and the lines $\arg n = \pm\pi/2$ are Stokes rays. We note that nothing special happens to the function on these lines, while the asymptotic series has the same shape. The discontinuity lies in the link between the series and its BE sum.

4.4f Limitations of classical Borel summation

The need of extending Borel summation to BE summation arises because the domain of definition of Borel summation is not wide enough; series occurring in even simple equations are not always Borel summable. A formal solution of $f' + f = 1/x$ is $\tilde{f} = \sum_{k=0}^\infty k!x^{-k-1}$. Then, since $\sum \mathcal{B}\tilde{f} = (1 - p)^{-1}$ is *not* Laplace transformable, because of the nonintegrable singularity at $p = 1$, \tilde{f} is not Borel summable.

While in a particular context one can avoid the singularity by slightly rotating the contour of \mathcal{L} in the complex plane, there is clearly no *one* ray of integration that would allow for arbitrary location of the singularities of general formal solutions of say differential equations.

We cannot impose restrictions on the *location* of singularities in Borel plane without giving up trivial changes of variable such as $x_1 = xe^{i\phi}$.

If the ray of integration has to depend on \tilde{f} , then linearity of the summation operator becomes a serious problem (and so is commutation with complex conjugation).

Écalle has found general averages of analytic continuations in Borel plane, which do not depend on the origin of the formal series, such that, replacing the

Laplace transform along a *singular rays* with averages of Laplace transforms of these continuations, the properties of Borel summation are preserved, and its domain is vastly widened. The fact that such averages exist is nontrivial, though many averages are quite simple and explicit.

Multiplicativity of the summation operator is the main difficulty that is overcome by these special averages. Perhaps surprisingly, convolution (the image of multiplication through \mathcal{L}^{-1}), *does not* commute in general with analytic continuation along curves passing between singularities! (See §5.11a.)

A simplified form of medianization, the balanced average, which works for generic ODEs (but not in the generality of Écalle’s averages) is discussed in §5.10.

Mixtures of different factorial rates of divergence in the same series, when present, usually preclude classical Borel summation as well. Acceleration and multisummation (the latter considered independently, from a cohomological point of view by Ramis; see also §8.2), universal processes too, were introduced by Écalle to deal with this problem in many contexts. Essentially BE summation is Borel summation, supplemented by averaging and acceleration when needed.

(Also, the domain of definition of classical Borel summation does not, of course, include transseries, but this is not a serious problem since the definition $\mathcal{LB}\exp(ax) = \exp(ax)$ solves it.)

4.5 Gevrey classes, least term truncation and Borel summation

Let $\tilde{f} = \sum_{k=0}^{\infty} c_k x^{-k}$ be a formal power series, with power-one of factorial divergence, and let f be a function asymptotic to it. The definition (1.12) provides estimates of the value of $f(x)$ for large x , within $o(x^{-N})$, $N \in \mathbb{N}$, which are, as we have seen, insufficient to determine a unique f associated to \tilde{f} . Simply widening the sector in which (1.12) is required cannot change this situation since, for instance, $\exp(-x^{1/m})$ is beyond all orders of \tilde{f} in a sector of angle almost $m\pi$.

If, however, by truncating the power series at some suitable $N(x)$ instead of a fixed N , we can achieve exponentially good approximations in a sector of width more than π , then uniqueness is ensured, by Exercise 2.29.

This leads us to the notion of Gevrey asymptotics.

Gevrey asymptotics.

$$\tilde{f}(x) = \sum_{k=0}^{\infty} c_k x^{-k}, \quad x \rightarrow \infty$$

is by definition Gevrey of order $1/m$, or Gevrey- $(1/m)$ if

$$|c_k| \leq C_1 C_2^k (k!)^m$$

for some C_1, C_2 [5]. There is an immediate generalization to noninteger power series. Taking $x = y^m$ and $\tilde{g}(y) = \tilde{f}(x)$, then \tilde{g} is Gevrey-1 and we will focus on this case. Also, the corresponding classification for series in $z, z \rightarrow 0$ is obtained by taking $z = 1/x$.

Remark 4.129 The Gevrey order of the series $\sum_k (k!)^r x^{-k}$, where $r > 0$, is the same as that of $\sum_k (rk)! x^{-k}$. Indeed, if $\epsilon > 0$ we have, by Stirling's formula,

$$Const (1 + \epsilon)^{-k} \leq (rk)! / (k!)^r \sim Const k^{\frac{1}{2}-r} \leq Const (1 + \epsilon)^k$$

*

Definition 4.130 Let \tilde{f} be Gevrey-one. A function f is Gevrey-one asymptotic to \tilde{f} as $x \rightarrow \infty$ in a sector S if for some C_3, C_4, C_5 , all $x \in S$ with $|x| > C_5$ and all N we have

$$|f(x) - \tilde{f}^{[N]}| \leq C_1 C_2^{N+1} |x|^{-N-1} (N + 1)! \tag{4.131}$$

i.e., if the error $f - \tilde{f}^{[N]}$ is, up to powers of a constant, of the same size as the first omitted term in \tilde{f} .

Note the *uniformity requirement* in N and x ; this plays a crucial role.

Remark 4.132 (Exponential accuracy) If \tilde{f} is Gevrey-one and the function f is Gevrey-one asymptotic to \tilde{f} , then f can be approximated by \tilde{f} with exponential precision in the following way. Let $N = \lfloor |x/C_2| \rfloor$ ($\lfloor \cdot \rfloor$ is the integer part); then for any $C > C_2$ we have

$$f(x) - \tilde{f}^{[N]}(x) = O(x^{1/2} e^{-|x|/C}), \quad (|x| \text{ large}) \tag{4.133}$$

Indeed, letting $|x| = NC_2 + \epsilon$ with $\epsilon \in [0, 1)$ and applying Stirling's formula we have

$$N!(N + 1)C_2^N |NC_2 + \epsilon|^{-N-1} = O(x^{1/2} e^{-|x|/C_2}) \quad \square$$

Note 4.134 *Optimal truncation*, or least term truncation, see e.g., [19], is in a sense a refined version of Gevrey asymptotics. It requires *optimal constants* in addition to an improved form of Rel. (4.131). In this way the imprecision of approximation of f by \tilde{f} turns out to be smaller than the largest of the exponentially small corrections allowed by the problem where the series originated. Thus the cases in which uniqueness is ensured are more numerous. Often, optimal truncation means stopping near the least term of the series, and this is why this procedure is also known as *summation to the least term*.

4.5a Connection between Gevrey asymptotics and Borel summation

The following theorem goes back to Watson [38].

Theorem 4.135 *Let $\tilde{f} = \sum_{k=2}^{\infty} c_k x^{-k}$ be a Gevrey-one series and assume the function f is analytic for large x in $S_{\pi+} = \{x : |\arg(x)| < \pi/2 + \delta\}$ for some $\delta > 0$ and Gevrey-one asymptotic to \tilde{f} in $S_{\pi+}$. Then*

(i) f is unique.

(ii) $\mathcal{B}(\tilde{f})$ is analytic (at $p = 0$ and) in the sector $S_{\delta} = \{p : \arg(p) \in (-\delta, \delta)\}$, and Laplace transformable in any closed subsector.

(iii) \tilde{f} is Borel summable in any direction $e^{i\theta}\mathbb{R}^+$ with $|\theta| < \delta$ and $f = \mathcal{LB}_{\theta}\tilde{f}$.

(iv) Conversely, if \tilde{f} is Borel summable along any ray in the sector S_{δ} given by $|\arg(x)| < \delta$, and if $\mathcal{B}\tilde{f}$ is uniformly bounded by $e^{\nu|p|}$ in any closed subsector of S_{δ} , then f is Gevrey-1 with respect to its asymptotic series \tilde{f} in the sector $|\arg(x)| \leq \pi/2 + \delta$.

Note. In particular, when the assumptions of the theorem are met, Borel summability follows using only *asymptotic estimates*.

The Nevanlinna-Sokal theorem [54] weakens the conditions sufficient for Borel summability, requiring essentially estimates in a half-plane only. It was originally formulated for expansions at zero, essentially as follows:

Theorem 4.136 (Nevanlinna-Sokal) Let f be analytic in $C_R = \{z : \operatorname{Re}(1/z) > R^{-1}\}$ and satisfy the estimates

$$f(z) = \sum_{k=0}^{N-1} a_k z^k + R_N(z) \tag{4.137}$$

with

$$|R_N(z)| \leq A\sigma^N N!|z|^N \tag{4.138}$$

uniformly in N and in $z \in C_R$. Then $B(t) = \sum_{n=0}^{\infty} a_n t^n/n!$ converges for $|t| < 1/\sigma$ and has analytic continuation to the strip-like region $S_{\sigma} = \{t : \operatorname{dist}(t, \mathbb{R}^+) < 1/\sigma\}$, satisfying the bound

$$|B(t)| \leq K \exp(|t|/R) \tag{4.139}$$

uniformly in every $S_{\sigma'}$ with $\sigma' > \sigma$. Furthermore, f can be represented by the absolutely convergent integral

$$f(z) = z^{-1} \int_0^{\infty} e^{-t/z} B(t) dt \tag{4.140}$$

for any $z \in C_R$. Conversely, if $B(t)$ is a function analytic in $S_{\sigma''}$ ($\sigma'' < \sigma$) and there satisfying (4.139), then the function f defined by (4.140) is analytic in C_R , and satisfies (4.137) and (4.138) [with $a_n = B^{(n)}(t)|_{t=0}$] uniformly in every $C_{R'}$ with $R' < R$.

Note 4.141 Let us point out first a possible pitfall in proving Theorem 4.135. Inverse Laplace transformability of f and analyticity away from zero in some sector follow immediately from the assumptions. What does not follow immediately is analyticity of $\mathcal{L}^{-1}f$ at zero. On the other hand, $\mathcal{B}\tilde{f}$ clearly converges to an analytic function near $p = 0$. But there is no guarantee that $\mathcal{B}\tilde{f}$ has anything to do with $\mathcal{L}^{-1}f$! This is where Gevrey estimates enter.

PROOF of Theorem 4.135

(i) Uniqueness clearly follows once we prove (ii).

(ii) and (iii) By a simple change of variables we arrange $C_1 = C_2 = 1$. The series $\tilde{F}_1 = \mathcal{B}\tilde{f}$ is convergent for $|p| < 1$ and defines an analytic function, F_1 . By Proposition 2.12, the function $F = \mathcal{L}^{-1}f$ is analytic for $|p| > 0, |\arg(p)| < \delta$, and $F(p)$ is analytic and uniformly bounded if $|\arg(p)| < \delta_1 < \delta$. We now show that F is analytic for $|p| < 1$. (A different proof is seen in §4.5a.1.) Taking p real, $p \in [0, 1)$ we obtain in view of (4.131) that

$$\begin{aligned} |F(p) - \tilde{F}^{[N-1]}(p)| &\leq \int_{-i\infty+N}^{i\infty+N} d|s| \left| f(s) - \tilde{f}^{[N-1]}(s) \right| e^{\operatorname{Re}(ps)} \\ &\leq N!e^{pN} \int_{-\infty}^{\infty} \frac{dx}{|x + iN|^N} = N!e^{pN} \int_{-\infty}^{\infty} \frac{dx}{(x^2 + N^2)^{N/2}} \\ &\leq \frac{N!e^{pN}}{N^{N-1}} \int_{-\infty}^{\infty} \frac{d\xi}{(\xi^2 + 1)^{N/2}} \leq CN^{3/2}e^{(p-1)N} \rightarrow 0 \text{ as } N \rightarrow \infty \end{aligned} \tag{4.142}$$

for $0 \leq p < 1$. Thus $\tilde{F}^{[N-1]}(p)$ converges. Furthermore, the limit, which by definition is F_1 , is seen in (4.142) to equal F , the inverse Laplace transform of f on $[0, 1)$. Since F and F_1 are analytic in a neighborhood of $(0, 1)$, $F = F_1$ wherever *either* of them is analytic⁹. The domain of analyticity of F is thus, by (ii), $\{p : |p| < 1\} \cup \{p : |p| > 0, |\arg(p)| < \delta\}$.

(iv) Let $|\phi| < \delta$. We have, by integration by parts,

$$f(x) - \tilde{f}^{[N-1]}(x) = x^{-N} \mathcal{L} \frac{d^N}{dp^N} F \tag{4.143}$$

On the other hand, F is analytic in S_a , some $a = a(\phi)$ -neighborhood of the sector $\{p : |\arg(p)| < |\phi|\}$. Estimating Cauchy’s formula on a radius- $a(\phi)$ circle around the point p with $|\arg(p)| < |\phi|$ we get

$$|F^{(n)}(p)| \leq N!a(\phi)^{-N} \|F(p)\|_{\infty; S_a}$$

Thus, by (4.143), with $\theta, |\theta| \leq |\phi|$, chosen so that $\gamma = \cos(\theta - \arg(x))$ is maximal we have

⁹Here and elsewhere we identify a function with its analytic continuation.

$$\begin{aligned}
 |f(x) - \tilde{f}^{[N]}| &= \left| x^{-N} \int_0^\infty \exp(-i\theta) F^{(N)}(p) e^{-px} dp \right| \\
 &\leq N! a^{-N} |x|^{-N} \|F e^{\nu|p} \|_{\infty; S_a} \int_0^\infty e^{-px + \nu|p| \gamma} dp \\
 &= \text{const.} N! a^{-N} \gamma^{-1} |x|^{-N-1} \|F\|_{\infty; S_a} \quad (4.144)
 \end{aligned}$$

for large enough x .

□

4.5a.1 Sketch of the proof of Theorem 4.136

We can assume that $f(0) = f'(0) = 0$ since subtracting out a finite number of terms of the asymptotic expansion does not change the problem. Then, we take to $x = 1/z$ (essentially, to bring the problem to our standard setting).

Let

$$F = \frac{1}{2\pi i} \int_{c-i\infty}^{c+i\infty} f(1/x) e^{px} dx = \frac{1}{2\pi i} \int_{c-i\infty}^{c+i\infty} g(x) e^{px} dx$$

We now want to show analyticity in S_σ of F . That, combined with the proof of Theorem 4.135 completes the argument.

We have

$$f(x) = \sum_{j=2}^{N-1} \frac{a_j}{x^j} + R_N(x)$$

and thus,

$$F(p) = \sum_{j=2}^{N-1} \frac{a_j p^{j-1}}{(j-1)!} + \frac{1}{2\pi i} \int_{c-i\infty}^{c+i\infty} R_N(1/x) e^{px} dx$$

and thus

$$|F^{(N-2)}(p)| = \left| \frac{a_{N-1}}{N-1} + \frac{1}{2\pi i} \int_{c-i\infty}^{c+i\infty} x^{N-2} R_N(1/x) e^{px} dx \right| \leq A_2 \sigma^N N!; \quad p \in \mathbb{R}^+$$

and thus $|F^{(n)}(p)/n!| \leq A_3 n^2 \sigma^n$, and the Taylor series of F at any point $p_0 \in \mathbb{R}^+$ converges, by Taylor’s theorem, to F , and the radius of convergence is σ . The bounds at infinity follow in the usual way: let $c = R^{-1}$. Since f is analytic for $\text{Re } x > c$ and is uniformly bounded for $\text{Re } x \geq c$, we have

$$\left| \int_{c-i\infty}^{c+i\infty} f(1/x) e^{px} dx \right| \leq K_1 e^{cp} \int_{-\infty}^\infty \frac{dx}{x^2 + 1} \leq K_2 e^{cp} \quad (4.145)$$

for $p \in \mathbb{R}^+$. In the strip, the estimate follows by combining (4.145) with the local Taylor formula.

Note 4.146 As we see, *control over the analytic properties of $\mathcal{B}\tilde{f}$ near $p = 0$ is essential to Borel summability and, it turns out, BE summability.* Certainly, mere inverse Laplace transformability of a function with a given asymptotic series, in however large a sector, does not ensure Borel summability of its series. We know already that for any power series, for instance one that is not Gevrey of finite order, we can find a function f analytic and asymptotic to it in more than a half-plane (in fact, many functions). Then $(\mathcal{L}^{-1}f)(p)$ exists, and is analytic in an open sector in p , origin not necessarily included. Since the series is not Gevrey of finite order, it can't be Borel summable. What goes wrong is the behavior of $\mathcal{L}^{-1}f$ at zero.

4.6 Borel summation as analytic continuation

There is another interpretation showing that Borel summation should commute with all operations. Returning to the example $\sum_{k=0}^{\infty} k!(-x)^{-k-1}$, we can consider the more general sum

$$\sum_{k=0}^{\infty} \frac{(-1)^k \Gamma(\beta k + \beta)}{x^{k+1}} \tag{4.147}$$

which for $\beta = 1$ agrees with (1.48). For $\beta = i$, (4.147) converges if $|x| > 1$, and the sum is, using the integral representation for the Gamma function and dominated convergence,

$$\int_0^{\infty} \frac{e^{-x}}{1 + p^{\beta} x^{\beta-1}} dp \tag{4.148}$$

Analytic continuation of (4.148) back to $\beta = i$ becomes precisely (1.52).

Exercise 4.149 *Complete the details in the calculations above. Show that continuation to i and to $-i$ gives the same result (1.52).*

Thus Borel summation should commute with all operations with which analytic continuation does. This latter commutation is very general, and comes under the umbrella of the vaguely stated “principle of permanence of relations” which can hardly be formulated rigorously without giving up some legitimate “relations.”

Exercise 4.150 (*) *Complete the proof of Theorem 4.136.*

4.7 Notes on Borel summation

BE works very well in problems such as (singular) differential, partial differential, and difference equations. We have seen that (1) due to the closure of transseries under operations, often formal transseries solutions exist; (2) they usually diverge due to the presence of repeated differentiation in the process of generating them. Some of the reasons why Borel summation is natural in these classes of problems are sketched in §4.7b.

But Borel summation has been successfully applied in problems in which divergence is generated in other ways. There is likely quite a bit more to understand and room for developing the theory.

Note 4.151 Summation naturally extends to transseries. In practice however, rarely does one need to Borel sum more than one level in a transseries¹⁰: once the lowest level has been summed, usually the remaining sums are convergent; we will then not address multilevel summation in this book.

4.7a Choice of critical time

1. To ensure Borel summability, we change the independent variable so that, with respect to the new variable t the coefficient c_α of $t^{-\alpha}$ is $\Gamma(\alpha + 1)$, up to geometrically bounded prefactors. This is the order of growth implied by Watson’s lemma. The order of growth is intimately linked to the form of free small exponential corrections, as explained in §4.7a.1 below. If these are of the form e^{-x^q} , then divergence is usually like $(n!)^{1/q}$. The variable should then be chosen to be $t = x^q$: this t is the *critical time*.
2. The choice of “ t ” and preparation of the equation are essential however for the process to succeed; see 2 in §4.7a.1. Since $(d/dt)^{2n} = (d^2/dt^2)^n$ iterating the n -th order derivative on a power series produces power one of the factorial divergence, regardless of n . For instance, iterating the operator in (4.68) produces the same divergence as iterating simply D . This partly explains the similarity in summability properties between differential and difference equations. As another example, in (4.52), the divergence is the same as that produced by iteration of $d/(x^{1/2}dx) \sim d/d(x^{3/2})$ so $t = x^{3/2}$. See also §4.3a and 1 in §4.7a.1 and §4.7b.
3. Often series fail to be Borel summable because of singularities in the direction of the Laplace transforms, or different types of factorial diver-

¹⁰That is, terms appearing in higher iterates of the exponential.

gence being mixed together. BE summation extends Borel summation and addresses these difficulties. See §4.4f.

4.7a.1 Critical time, rate of divergence, exponentially small corrections.

1. (a) If we expect the solutions of an equation to be summable with respect to a power of the variable, then the possible freedom in choosing the Laplace contour in the complex domain should be compatible with the type of freedom in the solutions.

In returning to the original space, the Laplace transform $f(x; \phi) = \int_0^\infty e^{i\phi} F(p)e^{-xp} dp$ can be taken along any nonsingular direction if exponential bounds exist at infinity. For instance we can take the Laplace transform of $(1 - p)^{-1}$ along any ray other than \mathbb{R}^+ , and obtain a solution of $f' + f = 1/x$. An upper half-plane transform differs from a lower half-plane transform precisely by $2\pi ie^{-x}$. Now, if F is analytic in a neighborhood of \mathbb{R}^+ but is not entire, then, by Watson’s lemma $f(x; \phi)$ has an asymptotic series in x^{-1} of Gevrey order exactly one; note that, under the same assumptions, the difference between two Laplace transforms on two sides of a singularity p_0 of the integrand, F , is of the form $e^{-p_0 x + o(x)}$.

Thus, if the Gevrey order of a formal solution is k , we need to take $x^{1/k}$ as a variable, otherwise the discussion above shows that proper Borel summation cannot succeed.

(b) Conversely then, if the difference between two solutions is of the form e^{-x^q} , then divergence of the formal series is expected to be of factorial type $(n!)^{1/q}$.

2. It is crucial to perform Borel summation in the adequate variable. If the divergence is not fully compensated (undersummation), then obviously we are still left with a divergent series. “Oversummation,” the result of overcompensating divergence usually leads to superexponential growth of the transformed function. The presence of singularities in Borel plane is in fact a good sign. For Equation (4.40), the divergence is like $\sqrt{n!}$. The equation is oversummed if we inverse Laplace transform it with respect to x ; what we get is

$$2H' - pH = 0; \quad H(0) = 1/2 \tag{4.152}$$

and thus $H = \frac{1}{2}e^{p^2/4}$. There are no singularities anymore but we have superexponential growth; this combination is a sign of oversummation. Superexponential growth is in certain ways worse than the presence of singularities. Close to the real line, there is no obvious way of taking the Laplace transform of H .

3. In some cases, a simple change of variable in the x -plane, as we have seen, can solve the problem. Here, the freedom (difference between solutions) in (4.40) Ce^{-x^2} . The critical time is $t = x^2$. We then take $g = h(x^2)$. The equation for h is

$$h' + h = \frac{1}{2\sqrt{t}} \tag{4.153}$$

for which summation succeeds; see (4.154).

4. If the solutions of an equation are summable, then it is expected that the transformed equation should be more regular. In this sense, Borel summation is a regularizing transformation; see also §7.2 where this feature is very useful.

In the case of (4.153) it becomes

$$-pH + H = p^{-1/2}\pi^{-1/2} \tag{4.154}$$

an algebraic equation, with algebraic singularities. The transformed function is more regular.

4.7b Discussion: Borel summation and differential and difference systems

We recall that, in differential systems, a problem is singularly perturbed if the highest derivative does not participate in the dominant balance; the highest derivative is then discarded to leading order. It reappears eventually, in higher order corrections. Then higher and higher corrections contain derivatives of increasing order. For analytic nonentire functions, by Cauchy’s formula, $f^{(n)}$ grows roughly like $const^n n!$.

It is then natural to diagonalize the main part of the operator producing divergence. For instance, in (4.40) it is $d/(2xdx) = d/dx^2 := d/dt$: then, by definition, in transformed space, d/dt becomes multiplication by the dual variable p . Repeated differentiation corresponds to repeated multiplication by p . The latter operation produces geometric growth/decay and thus nonzero radii of convergence of the expansion.

The operator d/dt is diagonalized by the Fourier transform. In an asymptotic problem, say for a large variable t , we need to keep t large in the transform process. The Fourier transform on a vertical contour in the complex domain is in fact an inverse Laplace transform, cf. also Remark 2.8.

In this sense, the pair $(\mathcal{L}, \mathcal{L}^{-1})$, in appropriate coordinates, is canonically associated to summation of formal solutions of singularly perturbed equations.

4.8 Borel transform of the solutions of an example ODE, (4.54)

For generic differential systems there exist general results on the Borel summability of formal transseries solutions; see §5. The purpose now is to illustrate a strategy of proof that is convenient and which applies to a reasonably large class of settings.

It would be technically awkward to prove, based on the formal series alone, that the Borel transform extends analytically along the real line and that it has the required exponential bounds towards infinity.

A better approach is to control the Borel transform of \tilde{y} via the equation it satisfies. This equation is the formal inverse Laplace transform of (4.54), namely, setting $Y = \mathcal{B}\tilde{y}$

$$-pY + Y = p + Y * Y * Y := p + Y^{*3} \quad (4.155)$$

We then show that the equation (4.155) has a (unique) solution which is analytic in a neighborhood of the origin and in any sector not containing \mathbb{R}^+ in which this solution has exponential bounds. Thus Y is Laplace transformable, except along \mathbb{R}^+ , and immediate verification shows that $y = \mathcal{L}Y$ satisfies (4.54). Furthermore, since the Maclaurin series $S(Y)$ formally satisfies (4.155), then the formal Laplace (inverse Borel) transform $\mathcal{B}^{-1}SY$ is a *formal* solution of (4.54), and thus equals \tilde{y} since this solution, as we proved in many similar settings, is unique. But since $SY = \mathcal{B}\tilde{y}$ it follows that \tilde{y} is Borel summable, except along \mathbb{R}^+ , and the Borel sum solves (4.54). The analysis of (4.54) in Borel plane is given in detail in §5.3.

Along \mathbb{R}^+ there are singularities, located at $p = 1 + \mathbb{N}$. Medianization allows BE summation along \mathbb{R}^+ too.

The transformed equations are expected to have analytic solutions—which are therefore more regular than the original ones.

Further analysis of the convolution equations reveals the detailed analytic structure of $\mathcal{B}\tilde{y}$, including the position and type of singularities, needed in understanding the Stokes phenomena in the actual solutions.

*

*4.9 Appendix: Rigorous construction of transseries

This section can be largely omitted at a first reading except when rigor, further information, or precise definitions and statements are needed.

Écalle’s original construction is summarized in [34]. Alternative constructions are given in [3] and [40]. An interesting recent extension is found in [35].

This section is based on [22] and it provides the proofs needed to back up the statements in §4.2a. Following the steps involved in the rigorous construction of transseries is needed in order to fully understand their structure, the reason why so many problems have transseries solutions, as well as the various limitations of transseries.

4.9a Abstracting from §4.2b

1. Let $(\mathcal{G}, \cdot, \gg)$ be a finitely generated, totally ordered (any two elements are comparable) Abelian group, with generators $\mu_1, \mu_2, \dots, \mu_n$, such that \gg is compatible with the group operations, that is, $g_1 \gg g_2$ and $g_3 \gg g_4$ implies $g_1 g_3 \gg g_2 g_4$, and so that $1 \gg \mu_1 \gg \dots \gg \mu_n$. This is the case when μ_i are transmonomials of level zero.
2. We write $\mu_{\mathbf{k}} = \mu^{\mathbf{k}} := \mu_1^{k_1} \dots \mu_n^{k_n}$.

Lemma 4.156 *Consider the partial order relation on \mathbb{Z}^n , $\mathbf{k} \succ \mathbf{m}$ iff $k_i \geq m_i$ for all $i = 1, 2, \dots, n$ and at least for some j we have $k_j > m_j$. If $B \subset A = \{\mathbf{k} \in \mathbb{Z}^n : \mathbf{k} \succeq \mathbf{m}\}$, then there is no infinite nonascending chain in B . That is, there is no infinite sequence in $B, b_n \neq b_m$ for $n \neq m$, and $b_{n+1} \not\succeq b_n$ for all n .*

PROOF Assume $\{\mathbf{k}(m)\}_{m \in \mathbb{N}^+}$ is an infinite nonascending sequence. Then at least for some $i \in \{1, 2, \dots, n\}$ the sequence $\{k_i(m)\}_{m \in \mathbb{N}^+}$ must have infinitely many distinct elements. Since the $k_i(m)$ are bounded below, then the set $\{k_i(m)\}_{m \in \mathbb{N}^+}$ is unbounded above, and we can extract a strictly increasing subsequence $\{k_i(m_l)\}_{l \in \mathbb{N}^+}$. We now take the sequence $\{\mathbf{k}(m_l)\}_{l \in \mathbb{N}^+}$. At least for some $j \neq i$ the set $k_j(m_l)$ needs to have infinitely many elements too. Indeed if the sets $\{k_j(m_l); j \neq i\}$ are finite, we can split $\{\mathbf{k}(m_l)\}_{l \in \mathbb{N}^+}$ into a finite set of subsequences, in each of which all $k_j(m_l), j \neq i$, are constant while k_i is strictly increasing. But every such subsequence would be strictly decreasing, which is impossible. By finite induction, we can extract a subsequence $\{\mathbf{k}(m_t)\}_{t \in \mathbb{N}^+}$ of $\mathbf{k}(m)\}_{m \in \mathbb{N}^+}$ in which all $k_l(m_t)$ are increasing, a contradiction. \square

Remark. This is a particular, much easier result of J. Kruskal’s tree theorem which we briefly mention here. A relation is well-founded if and only if there is no countable infinite descending sequence $\{x_j\}_{j \in \mathbb{N}^+}$ of elements of X such that $x_{n+1} R x_n$ for every $n \in \mathbb{N}^+$. The relation R is a quasi-order if it is reflexive and transitive. Well-quasi-ordering is a well-founded quasi-ordering such that there is no sequence $\{x_j\}_{j \in \mathbb{N}^+}$ with

$x_i \not\prec x_j \forall i < j$. A tree is a collection of vertices in which any two vertices are connected by exactly one line. *J. Kruskal's tree theorem states that the set of finite trees over a well-quasi-ordered set is well-quasi-ordered.*

3. *Exercises.* (1) Show that the equation $\mathbf{k}_1 + \mathbf{k}_2 = \mathbf{l}$ has only finitely many solutions in the set $\{\mathbf{k} : \mathbf{k} \succeq \mathbf{m}\}$.
 (2) Show that for any $\mathbf{l} \in \mathbb{R}^n$ there can only be finitely many $p \in \mathbb{N}^+$ and $\mathbf{k}_j \in \mathbb{R}^n, j = 1, \dots, p$ such that $\mathbf{k}_1 + \mathbf{k}_2 + \dots + \mathbf{k}_p = \mathbf{l}$.

Corollary 4.157 *For any set $B \subset A = \{\mathbf{k} \in \mathbb{Z}^n : \mathbf{k} \succeq \mathbf{m}\}$ there is a set $B_1 = \text{mag}(B)$ with finitely many elements, such that $\forall b \in B \setminus B_1$ there exists $b_1 \in B_1$ such that $b_1 \prec b$.*

Consider the set of all elements which are not smaller than other elements of B , $B_1 = \{b_1 \in B | b \neq b_1 \Rightarrow b \not\prec b_1\}$. In particular, no two elements of B_1 can be compared with each other. But then, by Lemma 4.156 this set cannot be infinite since it would contain an infinite non-ascending chain.

Now, if $b \in B \setminus B_1$, then by definition there is a $b' \succ b$ in B . If $b' \in B_1$ there is nothing to prove. Otherwise there is a $b'' \succ b'$ in B . Eventually some $b^{(k)}$ must belong to B_1 , finishing the proof, otherwise $b \prec b' \prec \dots$ would form an infinite nonascending chain.

4. For any $\mathbf{m} \in \mathbb{Z}^n$ and any set $B \subset \{\mathbf{k} | \mathbf{k} \succeq \mathbf{m}\}$, the set $A = \{\mu_{\mathbf{k}} | \mathbf{k} \in B\}$ has a largest element with respect to \succ . Indeed, if such was not the case, then we would be able to construct an infinitely ascending sequence.

Lemma 4.158 *No set of elements of $\mu_{\mathbf{k}} \in \mathcal{G}$ such that $\mathbf{k} \succeq \mathbf{m}$ can contain an infinitely ascending chain, that is a sequence of the form*

$$g_1 \ll g_2 \ll \dots$$

PROOF For such a sequence, the corresponding \mathbf{k} would be strictly nonascending, in contradiction with Lemma 4.156. □

5. It follows that for any \mathbf{m} every $B \subset A_{\mathbf{m}} = \{g \in \mathcal{G} | g = \mu_{\mathbf{k}}; \mathbf{k} \succeq \mathbf{m}\}$ is well ordered (every subset has a largest element) and thus B can be indexed by ordinals. By this we mean that there exists a set of ordinals Ω (or, which is the same, an ordinal) which is in one-to-one correspondence with B and $g_{\beta} \ll g_{\beta'}$ if $\beta > \beta'$.
6. If A is as in 4, and if $g \in \mathcal{G}$ has a successor in A , that is, if there is a $\tilde{g} \in A, g \gg \tilde{g}$, then it has an immediate successor, the largest element in the subset of A consisting in all elements less than g . There

may not be an immediate predecessor though, as is the case of e^{-x} in $A_1 = \{x^{-n}, n \in \mathbb{N}\} \cup \{e^{-x}\}$. Note also that, although e^{-x} has infinitely many predecessors, there is no infinite ascending chain in A_1 .

Lemma 4.159 *For any $g \in \mathcal{G}$, and $\mathbf{m} \in \mathbb{Z}^n$, there exist finitely many (distinct) $\mathbf{k} \succeq \mathbf{m}$ such that $\mu_{\mathbf{k}} = g$.*

PROOF Assume the contrary. Then for at least one i , say $i = 1$ there are infinitely many k_i in the set of $(\mathbf{k})_i$ such that $\mu_{\mathbf{k}} = g$. As in Lemma 4.168, we can extract a strictly increasing subsequence. But then, along it, $\mu_1^{k_1} \cdots \mu_n^{k_n}$ would form an infinite strictly ascending sequence, a contradiction. \square

7. For any coefficients $c_{\mathbf{k}} \in \mathbb{R}$, consider the formal multiserries, which we shall call *transseries* over \mathcal{G} ,

$$T = \sum_{\mathbf{k} \in \mathbb{Z}^n; \mathbf{k} \succeq \mathbf{M}} c_{\mathbf{k}} \mu_{\mathbf{k}} \tag{4.160}$$

Transseries actually needed in analysis are constructed in the sequel, with a particular inductive definition of generators $\mu_{\mathbf{k}}$.

8. *More generally a **transseries over G** is a sum which can be written in the form (4.160) for some (fixed) $n \in \mathbb{N}^+$ and for **some choice of generators $\mu_{\mathbf{k}}$, $\mathbf{k} \in \mathbb{Z}^n$** .*
9. The fact that a transseries s is small does *not* mean that the corresponding $\mu_{\mathbf{k}}$ have positive \mathbf{k} ; s could contain terms such as $x e^{-x}$ or $x^{\sqrt{2}} x^{-2}$, etc. But positivity can be *arranged* by a suitable choice of generators as follows Lemma 4.168.
10. **Note.** The existence of a set $A_{\mathbf{m}}$ in the definition of transseries. Consider, for instance, in the group \mathcal{G} with two generators x^{-1} and $x^{-\sqrt{2}}$ an expression of the form

$$\sum_{\{(m,n) \in \mathbb{Z}^2 \mid m\sqrt{2} + n > 0\}} c_{mn} x^{-m\sqrt{2} - n} \tag{4.161}$$

This expression is not very meaningful: the possible powers in (4.161) are dense and the behavior of a function whose ‘‘asymptotic expansion is (4.161)’’ is not at all clear.

Exercise 4.162 *Consider the numbers of the form $m\sqrt{2} + n$, where $m, n \in \mathbb{Z}$. It can be shown, for instance using continued fractions, that one can choose a subsequence from this set such that $s_n \uparrow 1$. Show that $\sum_n x^{-s_n}$ is not a transseries over any group of monomials of order zero.*

Expressions similar to the one in the exercise do appear in some problems in discrete dynamics. The very fact that transseries are closed under many operations, including solutions of ODEs, shows that such functions are “highly transcendental.”

11. Given $\mathbf{m} \in \mathbb{Z}^n$ and $g \in \mathcal{G}$, the set $S_g = \{\mathbf{k} | \mu_{\mathbf{k}} = g\}$ contains, by Lemma 4.159 finitely many elements (possibly none). Thus the constant $d(g) = \sum_{\mathbf{k} \in S_g} c_{\mathbf{k}}$ is well defined. By 4 there is a largest $g = g_1$ in the set $\{\mu_{\mathbf{k}} | d(g) \neq 0\}$, unless all coefficients are zero. We call this g_1 the magnitude of T , $g_1 = \text{mag}(T)$, and we write $\text{dom}(T) = d(g_1)g_1 = d_1g_1$.
12. By 5, the set $\{g = \mu_{\mathbf{k}} | \mathbf{k} \succeq \mathbf{m}\}$ can be indexed by ordinals, and we write

$$T = \sum_{\beta \in \Omega} d_{\beta} g_{\beta} \tag{4.163}$$

where $g_{\beta} \ll g_{\beta'}$ if $\beta > \beta'$. By convention, the first element in (4.163), d_1g_1 is nonzero.

Convention. To simplify the notation and terminology, we will say, with some abuse of language, that a group element g_{β} appearing in (4.163) belongs to T .

Whenever convenient, we can also select the elements of $d_{\beta}g_{\beta}$ in T with nonzero coefficients. As a subset of a well-ordered set, it is well-ordered too, by a set of ordinals $\tilde{\Omega} \subset \Omega$ and we can write

$$T = \sum_{\beta \in \tilde{\Omega}} d_{\beta} g_{\beta} \tag{4.164}$$

where all d_{β} are nonzero.

13. **Notation** To simplify the exposition we will denote by $A_{\mathbf{m}}$ the set $\{\mu_{\mathbf{k}} | \mathbf{k} \succeq \mathbf{m}\}$, $\mathbf{K}_{\mathbf{m}} = \{\mathbf{k} | \mathbf{k} \succeq \mathbf{m}\}$ and $\mathcal{T}_{A_{\mathbf{m}}}$ the set of transseries over $A_{\mathbf{m}}$.
14. Any transseries can be written in the form

$$T = L + c + s = \sum_{\beta \in \Omega; g_{\beta} \gg 1} d_{\beta} g_{\beta} + c + \sum_{\beta \in \Omega; g_{\beta} \ll 1} d_{\beta} g_{\beta} \tag{4.165}$$

where L is called a purely large transseries, c is a constant and s is called a small transseries.

Note that L, c and s are transseries since, for instance, the set $\{\beta \in \Omega; g_{\beta} \ll 1\}$ is a subset of ordinals, thus an ordinal itself.

Note 4.166 The sum $\sum_{k=0}^{\infty} c_k s^k$ might belong to a space of transseries defined over a larger, but still finite, number of generators. For instance,

if

$$\frac{1}{xe^x + 1} = \frac{1}{xe^x(1 + xe^{-x})} = \frac{e^{-x}}{x} \sum_{j=0}^{\infty} (-1)^j x^j e^{-jx} \tag{4.167}$$

then the generators of (4.167) can be taken to be x^{-1}, e^{-x}, xe^{-x} , all small.

Lemma 4.168 *If \mathcal{G} is finitely generated, if $A_{\mathbf{m}} \subset \mathcal{G}$ and s is a small transseries over $A_{\mathbf{m}}$ we can always assume, for an $n \geq n'$ that the generators $\nu_{\mathbf{k}}, \mathbf{k} \in \mathbb{Z}^{n'}$ are such that for all $\nu_{\mathbf{k}'} \in s$ we have $\mathbf{k}' \succ 0$.*

$$s = \sum_{\mathbf{k} \succeq \mathbf{m}} \mu_{\mathbf{k}} c_{\mathbf{k}} = \sum_{\beta \in \tilde{\Omega}} d_{\beta} g_{\beta} = \sum_{\mathbf{k}' \succ 0} \nu_{\mathbf{k}'} c'_{\mathbf{k}'} \tag{4.169}$$

PROOF In the first sum on the left side we can retain only the set of indices I such that $\mathbf{k} \in I \Rightarrow \mu_{\mathbf{k}} = g_{\beta}$ has nonzero coefficient d_{β} . In particular, since all $g_{\beta} \ll 1$, we have $\mu_{\mathbf{k}} \ll 1 \forall \mathbf{k} \in I$. Let $I_1 = \text{Mag}(I)$. We adjoin to the generators of \mathcal{G} all the $\nu_{\mathbf{k}'} = \mu_{\mathbf{k}}$ with $\mathbf{k}' \in I_1$. The new set of generators is still finite and for all $\mathbf{k} \in I$ there is a $\mathbf{k}' \in \text{Mag}(I)$ such that $\mathbf{k} \succeq \mathbf{k}'$ and $\mu_{\mathbf{k}}$ can be written in the form $\nu_{\mathbf{k}'}^1 \mu_1$ where all $1 \succeq 0$. □

Remark. After the above construction, generally, there will be nontrivial relations between the generators. But nowhere do we assume that generators are relation-free, so this creates no difficulty.

- 15. An algebra over \mathcal{G} can be defined as follows. Let A and \tilde{A} be well-ordered sets in Ω . The set of pairs $(\beta, \tilde{\beta}) \in A \times \tilde{A}$ is well-ordered (check!). For every g , the equation $g_{\beta} \cdot g_{\tilde{\beta}} = g$ has finitely many solutions. Indeed, otherwise there would be an infinite sequence of g_{β} which cannot be ascending, thus there is a subsequence of them which is strictly descending. But then, along that sequence, $g_{\tilde{\beta}}$ would be strictly ascending; then the set of corresponding ordinals $\tilde{\beta}$ would form an infinite strictly descending chain, which is impossible. Thus, in

$$T \cdot \tilde{T} := \sum_{\gamma \in A \times \tilde{A}} g_{\gamma} \sum_{g_{\beta} \cdot g_{\tilde{\beta}} = g_{\gamma}} d_{\beta} d_{\tilde{\beta}} \tag{4.170}$$

the inner sum contains finitely many terms.

- 16. We denote by $\mathcal{T}_{\mathcal{G}}$ the algebra of transseries over \mathcal{G} . $\mathcal{T}_{\mathcal{G}}$ is a commutative algebra with respect to $(+, \cdot)$. We will see in the sequel that $\mathcal{T}_{\mathcal{G}}$ is in fact a field. We make it an ordered algebra by writing

$$T_1 \ll T_2 \Leftrightarrow \text{mag}(T_1) \ll \text{mag}(T_2) \tag{4.171}$$

and writing

$$T > 0 \Leftrightarrow \text{dom}(T) > 0 \tag{4.172}$$

17. **Product form.** With the convention $\text{dom}(0) = 0$, any transseries can be written in the form

$$T = \text{dom}(T)(1 + s) \tag{4.173}$$

where s is small (check).

18. Embeddings (cf. footnote 2 on p. 148). If $\mathcal{G}_1 \subset \mathcal{G}$, we write that $\mathcal{T}_{\mathcal{G}_1} \subset \mathcal{T}_{\mathcal{G}}$ in the natural way.
19. **Topology** on $\mathcal{T}_{\mathcal{G}}$. We consider a sequence of transseries over a *common* set $A_{\mathbf{m}}$ of elements of \mathcal{G} , indexed by the ordinal Ω .

$$\{T^{[j]}\}_{j \in \mathbb{N}^+}; \quad T^{[j]} = \sum_{\beta \in \beta} d_{\beta}^{[j]} g_{\beta}^{[j]}$$

Definition. We say that $T^{[j]} \rightarrow 0$ as $j \rightarrow \infty$ if for any $\beta \in \Omega$ there is a $j(\beta)$ such that the coefficient $d_{\beta}^{[j]} = 0$ for all if $j > j(\beta)$.

Thus the transseries $T^{[j]}$ must be *eventually depleted of all coefficients*. This aspect is very important. The mere fact that $\text{dom}(S) \rightarrow 0$ does not suffice to have a meaningful convergence. Indeed the sequence $\sum_{k>j} x^{-k} + je^{-x}$, though “rapidly decreasing” is not convergent according to the definition, and probably should not converge in any reasonable topology.

20. Equivalently, the sequence $T^{[j]} \rightarrow 0$ is convergent if there is a representation such that

$$T^{[j]} = \sum_{\mathbf{k} \geq \mathbf{m}} c_{\mathbf{k}}^{[j]} \mu_{\mathbf{k}} \tag{4.174}$$

and in the sum $\mu_{\mathbf{k}} = g$ has only one solution (we know that such a choice is possible), and $\min\{|k_1| + \dots + |k_n| : c_{\mathbf{k}}^{[j]} \neq 0\} \rightarrow 0$ as $j \rightarrow \infty$.

21. Let μ_1, \dots, μ_n be any generators for \mathcal{G} , $\mathbf{m} \in \mathbb{Z}^d$, as in 5 and $T_j \in \mathcal{T}_{A_{\mathbf{m}}}$ a sequence of transseries. Let $N_j := \min\{k_1 + \dots + k_n \mid \mu_1^{p_1} \dots \mu_n^{p_n} \in T_j\}$. Note that we can write \min since, by Lemma 4.156, the minimum value is attained (check this!). If $N_j \rightarrow \infty$, then $T_j \rightarrow 0$. Indeed, if this was not the case, then there would exist a g_{β} such that $g_{\beta} \in T_j$ with $d_{\beta} \neq 0$ for infinitely many j . Since $N_j \rightarrow \infty$ there is a sequence $\mu_{\mathbf{k}} \in A_{\mathbf{m}}$ such that $k_1 + \dots + k_n \rightarrow \infty$ and $\mu_{\mathbf{k}} = g_{\beta}$. This would yield an infinite set of solutions of $\mu_{\mathbf{k}} = g_{\beta}$ in $A_{\mathbf{m}}$, which is not possible. The function $\max\{e^{-(|k_1| + \dots + |k_n|)} : \sum_{\mu_{\mathbf{k}} = g} c_{\mathbf{k}} \neq 0\}$ is a semimetric (it satisfies all

properties of the metric except the triangle inequality) which induces the same topology.

More generally, transseries are a subset of functions f defined on \mathcal{G} with real values and for which there exists a $\mathbf{k}_0(f) = \mathbf{k}_0$ such that $f(g_{\mathbf{k}}) = 0$ for all $\mathbf{k} \prec \mathbf{k}_0$. On these functions we can define a topology by writing $f^{[j]} \rightarrow 0$ if $\mathbf{k}_0(f^{[j]})$ does not depend on j and for any g_{β} there is an N so that $f^{[n]}(g_{\beta}) = 0$ for all $n > N$. The first restriction is imposed to disallow, say, the convergence of x^n to zero, which would not be compatible with a good structure of transseries.

22. This topology, in a space of transseries over $A_{\mathbf{m}}$, is metrizable. For example we can proceed as follows. The elements of \mathcal{G} are countable. We choose any counting on $A_{\mathbf{m}}$. We then identify transseries over $A_{\mathbf{m}}$ with the space \mathcal{F} of real-valued functions defined on the natural numbers. We define $d(f, g) = 1/n$ where n is the least integer such that $f(n) \neq g(n)$ and $d(f, f) = 0$. The only property that needs to be checked is the triangle inequality. Let $f, g, h \in \mathcal{F}$, $d(f, g) = 1/n$. If $d(g, h) \geq 1/n$, then clearly $d(f, g) \leq d(f, h) + d(h, g)$. If $d(g, h) < 1/n$, then $d(f, h) = 1/n$ and the inequality holds too. This metric is obviously not very natural, and there is no natural one we are aware of. In any case, a metric is not needed in the construction.
23. The topology cannot come from a norm, since in general $a_n \mu \not\rightarrow 0$ as $a_n \rightarrow 0$.
24. We also note that the topology is *not* compatible with the order relation. For example $s_n = x^{-n} + e^{-x} \rightarrow e^{-x}$ as $n \rightarrow \infty$, $s_n \gg e^{-\sqrt{x}}$ for all n while $e^{-x} \not\gg e^{-\sqrt{x}}$. The same argument shows that there is no distance compatible with the order relation.
25. In some sense, there is no “good” topology compatible with the order relation \ll . Indeed, if there was one, then the sequences $s_n = x^{-n}$ and $t_n = x^{-n} + e^{-x}$ which are interlaced in the order relation should have the same limit, but then addition would be discontinuous¹¹.
26. Giving up compatibility with asymptotic order allows us to ensure continuity of most operations of interest.

Exercise. Show that a Cauchy sequence in $\mathcal{T}_{A_{\mathbf{m}}}$, is convergent, and $\mathcal{T}_{A_{\mathbf{m}}}$ is a topological algebra.

27. If \mathcal{G} is finitely generated, then for any small transseries

$$s = \sum_{\beta \in \Omega: g_{\beta} \ll 1} d_{\beta} g_{\beta} \tag{4.175}$$

¹¹This example was pointed out by G. Edgar.

we have $s^j \rightarrow 0$ as $j \rightarrow \infty$.

PROOF Indeed, by Lemma 4.168 we may assume that the generators of \mathcal{G} , μ_1, \dots, μ_n , are chosen such that all $\mathbf{k} \succ 0$ in s . Let $g \in \mathcal{G}$. The terms occurring in the formal sum of s^j are of the form $const. \mu_{1+\dots+1_j}$. For every i , \mathbf{l}_i is $\succ 0$. This means that $\sum_{i=1}^j |\mathbf{l}_i| \rightarrow \infty$ ($|\mathbf{k}| = k_1 + \dots + k_n$) and the result follows from 21.

□

As a side remark, finite generation is not needed at this point. More generally, let $A \subset \mathcal{G}$ be well-ordered. It follows from J. Kruskal’s theorem that the set $\bar{A} \supset A$ of all products of elements of A is also well quasi-ordered.

28. In particular if $f(\mu) := \sum_{k=0}^{\infty} c_k \mu^k$ is a formal series and s is a small transseries, then

$$f(s) := \sum_{k=0}^{\infty} c_k s^k \tag{4.176}$$

is well defined.

Exercise 4.177 Show that f is continuous, in the sense that if $s = s^{[n]} \rightarrow 0$ as $n \rightarrow \infty$, then $f(s^{[n]}) \rightarrow c_0$.

29. If $T_1 \gg T_2$, $T_3 \ll T_1$ and $T_4 \ll T_2$, then $T_1 + T_3 \gg T_2 + T_4$. Indeed, $\text{mag}(T_1 + T_3) = \text{mag}(T_1)$ and $\text{mag}(T_2 + T_4) = \text{mag}(T_2)$.
30. It is easily checked that $(1 + s) \cdot 1/(1 + s) = 1$, where

$$\frac{1}{1 + s} := \sum_{j \geq 0} (-1)^j s^j \tag{4.178}$$

More generally we define

$$(1 + s)^a = 1 + a s + \frac{a(a - 1)}{2} s^2 + \dots$$

31. Writing $S = \text{dom}(S)(1 + s)$ we define $S^{-1} = \text{dom}(S)^{-1}(1 + s)^{-1}$.
32. If μ^r is defined for a real r , we then adjoin μ^r to \mathcal{G} and define

$$T^r := d_1^r g_1^r (1 + s)^r$$

33. If $\mu_j \mapsto \mu'_j$ is a differentiation, defined from the generators μ_j into $\mathcal{T}_{\mathcal{G}}$, where we assume that differentiation is compatible with the relations between the generators, we can extend it by $(g_1 g_2)' = g'_1 g_2 + g_1 g'_2$, $1' = 0$ to the whole of \mathcal{G} and by linearity to $\mathcal{T}_{\mathcal{G}}$,

$$\left(\sum_{\mathbf{k} \in \mathbb{Z}^n} c_{\mathbf{k}} \mu_{\mathbf{k}} \right)' = \sum_{j=1}^n \mu'_j \sum_{\mathbf{k} \in \mathbb{Z}^n} k_j c_{\mathbf{k}} \mu_1^{k_1} \cdots \mu_j^{k_j-1} \quad (4.179)$$

and the latter sum is a well defined finite sum of transseries.

Exercise. Show that with these operations $\mathcal{T}_{\mathcal{G}}$ is a differential field.

34. If s is a small transseries, we define

$$e^s = \sum_{k \geq 0} \frac{s^k}{k!} \quad (4.180)$$

Exercise. Show that e^s has the usual properties with respect to multiplication and differentiation.

35. **Transseries are limits of finite sums.** We let $\mathbf{m} \in \mathbb{Z}^n$ and $\mathbf{M}_p = (p, p, \dots, p) \in \mathbb{N}^n$. Show that

$$T_p := \sum_{g_{\beta} = \mu_{\mathbf{k}}; \mathbf{m} \preceq \mathbf{k} \preceq \mathbf{M}_p; \beta \in \Omega} d_{\beta} g_{\beta} \xrightarrow{p \rightarrow \infty} \sum_{\beta \in \Omega} d_{\beta} g_{\beta}$$

36. More generally, let \mathcal{G} be finitely generated and $\mathbf{k}_0 \in \mathbb{Z}$. Assume $s_{\mathbf{k}} \rightarrow 0$ as $\mathbf{k} \rightarrow \infty$. Then, for any sequence of real numbers $c_{\mathbf{k}}$, the sequence

$$\sum_{\mathbf{k}_0 \preceq \mathbf{k} \preceq \mathbf{M}_p} c_{\mathbf{k}} s_{\mathbf{k}} \quad (4.181)$$

where $\mathbf{M}_p = (p, \dots, p), p \in \mathbb{N}$ is Cauchy and the limit

$$\lim_{p \rightarrow \infty} \sum_{\mathbf{k}_0 \preceq \mathbf{k} \preceq \mathbf{M}_p} c_{\mathbf{k}} s_{\mathbf{k}} \quad (4.182)$$

is well defined. In particular, for a given transseries

$$T \triangleleft \mathbf{s} = \sum d_{\mathbf{k}} s_{\mathbf{k}} \quad (4.183)$$

we define the **transcomposition**

$$T \triangleleft \mathbf{s} = \sum_{\mathbf{k} \succeq \mathbf{k}_0} d_{\mathbf{k}} s_{\mathbf{k}} \quad (4.184)$$

37. As an example of transcomposition, we see that transseries are closed under right pseudo-composition with *large* (not necessarily purely large) transseries $\mathbf{T} = T_i; i = 1, 2, \dots, n$ by

$$T_1(1/\mathbf{T}) = \sum_{\mathbf{k} \succeq \mathbf{m}} c_{\mathbf{k}} \mathbf{T}^{-\mathbf{k}} \tag{4.185}$$

if

$$T_1 = \sum_{\mathbf{k} \succeq \mathbf{m}} c_{\mathbf{k}} \mu^{\mathbf{k}}$$

(cf. 27) We should mention that at this level of abstractness pseudo-composition may not behave as a composition, for instance it may not be compatible with chain rule in differentiation.

38. **Asymptotically contractive operators.** Contractivity is usually defined in relation to a metric, but given a topology, contractivity depends on the metric while convergence does not.

Definition 4.186 *Let first J be a linear operator from $\mathcal{T}_{A_{\mathbf{m}}}$ or from one of its subspaces, to $A_{\mathbf{k}}$,*

$$JT = J \sum_{\mathbf{k} \succeq \mathbf{m}} c_{\mathbf{k}} \mu_{\mathbf{k}} = \sum_{\mathbf{k} \succeq \mathbf{m}} c_{\mathbf{k}} J \mu_{\mathbf{k}} \tag{4.187}$$

Then J is called asymptotically contractive on $\tilde{A}_{\mathbf{m}}$ if

$$J \mu_{\mathbf{j}} = \sum_{\mathbf{p} > \mathbf{0}} c_{\mathbf{p}} \mu_{\mathbf{j}+\mathbf{p}} \tag{4.188}$$

Remark 4.189 Contractivity depends on the set of generators. We can, more generally say that an operator is contractive if there is an extension of the set of generators such that Condition (4.188) holds.

Remark 4.190 *It can be checked that contractivity holds if*

$$J \mu_{\mathbf{j}} = \sum_{\mathbf{p} > \mathbf{0}} c_{\mathbf{p}} \mu_{\mathbf{j}+\mathbf{p}} (1 + s_{\mathbf{j}}) \tag{4.191}$$

where $s_{\mathbf{j}}$ are small transseries.

Exercise 4.192 *Check that for any $\mu_{\mathbf{j}}$ we have*

$$\sup_{p > 0} \sum_{k=n}^{n+p} J^k \mu_{\mathbf{j}} \rightarrow 0$$

as $n \rightarrow \infty$.

We then have

$$JT = \sum_{\mathbf{k} \succeq \mathbf{m}} J\mu_{\mathbf{k}} \tag{4.193}$$

Definition 4.194 *The linear or nonlinear operator J is (asymptotically) contractive on the set $A \subset A_{\mathbf{m}}$ if $J : A \mapsto A$ and the following condition holds. Let T_1 and T_2 in A be arbitrary and let*

$$T_1 - T_2 = \sum_{\mathbf{k} \succeq \mathbf{m}} c_{\mathbf{k}}\mu_{\mathbf{k}} \tag{4.195}$$

Then

$$J(T_1) - J(T_2) = \sum_{\mathbf{k} \succeq \mathbf{m}} c'_{\mathbf{k}}\mu_{\mathbf{k}+\mathbf{p}_{\mathbf{k}}}(1 + s_{\mathbf{k}}) \tag{4.196}$$

where $\mathbf{p}_{\mathbf{k}} \succ 0$ and $s_{\mathbf{k}}$ are small.

Remark 4.197 The sum of asymptotically contractive operators is contractive; the composition of contractive operators, whenever defined, is contractive.

Theorem 4.198 (i) *If J is linear and contractive on $\mathcal{T}_{A_{\mathbf{m}}}$, then for any $T_0 \in \mathcal{T}_{A_{\mathbf{m}}}$ the fixed point equation $T = JT + T_0$ has a unique solution $T \in \mathcal{T}_{A_{\mathbf{m}}}$.*

(ii) *In general, if $A \subset A_{\mathbf{m}}$ is closed and $J : A \mapsto A$ is a (linear or non-linear) contractive operator on A , then $T = J(T)$ has a unique solution in A .*

PROOF We leave (i) to the reader. For (ii), note that the sequence $T_{n+1} = J(T_n)$ is convergent since for some coefficients $c_{j,\mathbf{k}}$ we have

$$J^q(T) - J(T) = \sum_{\mathbf{k} \succeq \mathbf{m}} c_{j,\mathbf{k}}\mu_{\mathbf{k}+q\mathbf{p}_{\mathbf{k}}} \rightarrow 0$$

as $q \rightarrow \infty$. Uniqueness is immediate. □

- 39. When working with transseries we often encounter fixed point problems in the form $X = Y + \mathcal{N}(X)$, where Y is given, X is the unknown Y is given, and \mathcal{N} is “small.”

Exercise. Show the existence of a unique inverse of $(1 + s)$ where s is a small transseries, by showing that the equation $T = 1 - sT$ is contractive.

40. For example ∂ is contractive on level zero transseries (see also [Note 4.53](#)). This is clear since in every monomial the power of x decreases by one. But note that ∂ is not contractive anymore if we add “terms beyond all orders,” e.g., $(e^{-x^2})' = -2xe^{-x^2} \gg e^{-x^2}$.
41. One reason the WKB method works near irregular singularities, where exponential behavior is likely, is that it reduces the level of the transseries to zero, where ∂ is contractive. Iterated exponentials almost never occur in differential/difference equations, and then the substitution $y = e^w$ achieves the level reduction.
42. We take the union

$$\mathcal{T} = \bigcup_{\mathcal{G}} \mathcal{T}_{\mathcal{G}}$$

with the natural embeddings. It can be easily checked that \mathcal{T} is a differential field too. The topology is that of inductive limit, namely a sequence of transseries converges if they all belong to some $\mathcal{T}_{\mathcal{G}}$ and they converge there.

43. One can check that algebraic operations, exponentiation, composition with functions for which composition is defined, are continuous wherever the functions are “ C^∞ .”

Exercise 4.199 Let $T \in A_{\mathbf{m}}$. Show that the set $\{T_1 \in A_{\mathbf{m}} | T_1 \ll T\}$ is closed.

4.10 Logarithmic-free transseries

4.10a Inductive assumptions

1. We have constructed level zero transseries. Transseries of any level are constructed inductively, level by level.

Since we have already studied the properties of abstract multiseries, the construction is relatively simple, all we have to do is essentially watch for consistency of the definitions at each level.

2. Assume finitely generated transseries of level at most n have already been constructed. We assume a number of properties, and then build level $n + 1$ transseries and show that these properties are conserved.

(a) Transmonomials μ_j of order at most N are totally ordered, with respect to two order relations, \ll and $<$. Multiplication is defined on the transmonomials, it is commutative and compatible with the order relations.

(b) For a set of n small transmonomials, a transseries of level at most N is defined as expression of the form (4.160).

It follows that the set $\{g = \mu_{\mathbf{k}} | \mathbf{k} \succeq \mathbf{m}\}$ can be indexed by ordinals, and we can write the transseries in the form (4.163). The decomposition (4.165) then applies.

It also follows that two transseries are equal iff their corresponding d_β coincide.

The order relations on transseries of level N are defined as before, $T \gg 1$ if, by definition $g_1 \gg 1$, and $T > 0$ iff $d_1 > 0$.

Transseries of level at most N are defined as the union of all $\mathcal{T}_{A_{\mathbf{m}}}$ where $A_{\mathbf{m}}$ is as before.

(c) A transmonomial of order at most N is of the form $x^a e^L$ where L is a purely large or null transseries of level $N - 1$, where e^L is recursively defined as a new object. We give an outline below. See §4.10b for full details. There are no transseries of level -1 , so for $N = 0$ we take $L = 0$.

(d) By definition, $x^a e^L = e^L x^a$ and $x^{a_1} e^{L_1} x^{a_2} e^{L_2} = x^{a_1+a_2} e^{L_1+L_2}$. Furthermore $e^{L_1} \gg x^a e^{L_2}$ for any a if $L_1 > 0$ is a purely large transseries of level strictly higher than the level of L_2 .

Exercise. Show that any transmonomial is of the form $x^a e^{L_1} e^{L_2} \dots e^{L_j}$ where L_j are of order exactly j meaning that they are of order j but not of lower order.

(e) If c is a constant, then e^c is a constant, the usual exponential of c , and if $L + c + s$ is the decomposition of a transseries of level $N - 1$, then we write $e^{L+c+s} = e^L e^c e^s$ where e^s is *reexpanded* according to Formula (4.180) and the result is a *transseries* of level N .

We convene to write e^T , for any T transseries of level at most N *only* in this reexpanded form.

Then it is always the case that $e^T = T_1 e^{L_1}$ where T_1 and L_1 are transseries of level $N - 1$ and L_2 is purely large or zero. The transseries e^T is finitely generated, with generators e^{-L_1} , if $L_1 > 0$ or e^{L_1} otherwise, together with all the generators of L_1 .

Sometimes it is convenient to adjoin to the generators of T all the generators in the exponents of the transmonomials in T , and then the generators in exponents in the exponents of the transmonomials in T , etc. Of course, this process is finite and we end up with a finite number of generators, which we will call *the complete set of generators* of T .

- (f) This **defines** the exponential of any transseries of level at most $N - 1$ if $L \neq 0$ and the exponential of any transseries of level at most N if $L = 0$. We can check that $e^{T_1} = e^{T_2}$ iff $T_1 = T_2$.
- (g) If all transseries of level N are written in the canonical form (4.163), then $T_1 = T_2$ iff all g_β at all levels have exactly the same coefficients. Transseries, in this way, have a unique representation in a strong sense.
- (h) For any transmonomial, $(x^a e^L)^r$ is defined as $x^{ar} e^{rL}$ where the ingredients have already been defined. It may be adjoined to the generators of \mathcal{G} and then, as in the previous section, T^r is well defined.
- (i) There is a differentiation with the usual properties on the generators, compatible with the group structure and equivalences. We have $(x^a e^L)' = ax^{a-1} x^L + x^a L' e^L$ where L' is a (finitely generated) transseries of level at most $N - 1$.

We define

$$T' = \sum_{\mathbf{k} \in \mathbb{Z}^n; \mathbf{k} \geq \mathbf{M}} c_{\mathbf{k}} [(x^{-\mathbf{k} \cdot \boldsymbol{\alpha}})' e^{-\mathbf{L} \cdot \boldsymbol{\beta}} + x^{-\mathbf{k} \cdot \boldsymbol{\alpha}} (e^{-\mathbf{L} \cdot \boldsymbol{\beta}})'] \quad (4.200)$$

where, according to the definition of differentiation, (4.200) is a finite sum of products of transseries of level at most N .

We have $T' = 0$ iff $T = const.$ If $\text{dom}(T_{1,2}) \neq const.$, then $T_1 \ll T_2$ implies $T'_1 \ll T'_2$.

3. It can be checked by induction that $T > 0, T \gg 1$ implies $T' > 0$. In this sense, differentiation is compatible with the order relations.
4. It can then be checked that differentiation has the usual properties.
5. The space of transseries of level N , $\mathcal{T}^{[N]}$, is defined as the union of all spaces of transseries over finitely generated groups of transmonomials of level N .

$$\mathcal{T}^{[N]} = \bigcup_{\mathcal{G}_N} \mathcal{T}_{\mathcal{G}_N}$$

with the inductive limit topology.

6. The abstract theory of transseries we have developed in the previous section applies. In particular we have by definition $1/(1 - s) = \sum_j s^j$ and $1/T = 1/\text{dom}(T)(1 + s)^{-1}$ and transseries of level N form a differential field closed under the operation of solving contractive mapping equations.
7. Note that transseries of order N are closed under the contractive mapping principle.

4.10b Passing from step N to step $N + 1$

1. We now proceed in defining transseries of level at most $N + 1$. We have to check that the construction preserves the properties in §4.10a.
2. For any purely large transseries of level N we define $x^a e^L$ to equal the already defined transmonomial of order N . If L is a (finitely generated) purely large transseries of level exactly N we define a new objects, $x^a e^L$, a transmonomial of order $N + 1$, having the properties

(a) $e^0 = 1$.

(b) $x^a e^L = e^L x^a$.

(c) $x^{a_1} e^{L_1} x^{a_2} e^{L_2} = x^{a_1+a_2} e^{L_1+L_2}$.

(d) If $L > 0$ is a purely large transseries of level exactly N , then $e^L \gg x^a$ for any a .

Exercise. Show that if L_1 and L_1 are purely large transseries and the level of L_1 strictly exceeds the level of L_2 , then $e^{L_1} \gg x^a e^{L_2}$ for any a .

Note that $L_1 \pm L_2$ may be of lower level, but it is either purely large or else zero; $L_1 L_2$ is purely large.

Note 4.201 At this stage, no meaning is given to e^L , or even to e^x ; they are treated as primitives. There are possibly many models of this construction. By BE summation, a subclass of transseries is isomorphically associated to set of functions. The symbol e^x corresponds to the usual exponential, convergent multiseries will correspond to their sums, etc.

3. If $\alpha > 0$ and L is a *positive* transseries of level N , we define a generator of order N to be $\mu = x^{-\alpha} e^{-L}$. We choose a number of generators μ_1, \dots, μ_n , and define the Abelian multiplicative group generated by them, with the multiplication rule just defined. We can check that \mathcal{G} is a totally ordered, of course finitely generated, Abelian group, and that the order relation is compatible with the group structure.
4. We can now define transseries over $\mathcal{G} = \mathcal{G}^{[N+1]}$ as in §4.9.
5. We define transseries of order $N + 1$ to be the union over all $\mathcal{T}_{\mathcal{G}^{[N+1]}}$, with the natural embeddings. We denote these transseries by $\mathcal{T}^{[N+1]}$.
6. *Compatibility of differentiation with the order relation.* We have already assumed that this is the case for transseries of level at most N . (i) We first show that it holds for transmonomials of level $N + 1$. If $L_1 - L_2$ is a

positive transseries, then $(x^a e^{L_1})' \gg (x^b e^{L_2})'$ follows directly from the formula of differentiation, the fact that $e^{L_1 - L_2}$ is large and the induction hypothesis. If $L_1 = L_2$ then $a > b$ and the property follows from the fact that L_1 is either zero, or else $L \gg x^\beta$ for some $\beta > 0$ for some positive β (check!).

(ii) For the general case we note that

$$\left(\sum_{\beta} d_{\beta} \mu_{\beta} \right)' = \sum_{\beta} d_{\beta} \mu'_{\beta}$$

and $\mu'_{\beta_1} \ll \mu'_{\beta_2}$ if $\beta_1 > \beta_2$. Then $\text{dom}(T)' = (\text{dom}(T))'$ and the property follows.

7. Differentiation is continuous. Indeed, if $T^{[m]} \rightarrow 0$,

$$T^{[m]} = \sum_{\mathbf{k} \succeq \mathbf{m}} c_{\mathbf{k}}^{[m]} x^{\mathbf{k} \cdot \mathbf{a}} e^{-\mathbf{k} \cdot \mathbf{L}} \rightarrow 0 \quad \text{as } m \rightarrow \infty$$

where the transseries L_1, \dots, L_n are purely large, then

$$(T^{[m]})' = \frac{1}{x} \sum_{\mathbf{k} \succeq \mathbf{m}} (\mathbf{k} \cdot \mathbf{a} c_{\mathbf{k}}^{[m]}) x^{\mathbf{k} \cdot \mathbf{a}} e^{-\mathbf{k} \cdot \mathbf{L} - \mathbf{L}'} \cdot \sum_{\mathbf{k} \succeq \mathbf{m}} (\mathbf{k} c_{\mathbf{k}}^{[m]}) x^{\mathbf{k} \cdot \mathbf{a}} e^{-\mathbf{k} \cdot \mathbf{L}}$$

and the rest follows from continuity of multiplication and the definition of convergence.

- 8. Therefore, if a property of differentiation holds for finite sums of transmonomials, then it holds for transseries.
- 9. By direct calculation, if μ_1, μ_2 are transmonomials of order $N + 1$, then $(\mu_1 \mu_2)' = \mu'_1 \mu_2 + \mu_1 \mu'_2$. Then, one can check by usual induction, the product rule holds for finite sums of transmonomials. Using 8 the product rule follows for general transseries.

4.10b.1 Composition

10. Composition *to the right* with a *large* (not necessarily purely large) transseries T of level m is defined as follows.

The power of a transseries $T = x^a e^L(1+s)$ is defined by $T^p = x^{ap} e^{pL}(1+s)^p$, where the last expression is well defined and $(T^p)' = pT'T^{p-1}$ (check).

The exponential of a transseries is defined, inductively, in the following way.

$$T = L + c + s \Rightarrow e^T = e^L e^c e^s = S e^L e^c \tag{4.202}$$

where S is given in (4.180).

A general exponential-free transseries of level zero has the form

$$T_0 = \sum_{\mathbf{k} \succeq \mathbf{m}} c_{\mathbf{k}} x^{-\mathbf{k} \cdot \boldsymbol{\alpha}} \tag{4.203}$$

where $(\alpha_1, \dots, \alpha_n) \in \mathbb{R}^{+n}$ for some n .

Then we take $\mathbf{T} = (T^{\alpha_1}, \dots, T^{\alpha_n})$ and define $T_0(1/T)$ by (4.185); $T_0(1/T)$ has level m . If the sum (4.203) contains finitely many terms, it is clear that $[T_0(1/T)]' = T_0'(1/T)T'$. By continuity, this is true for a general T_0 of level zero.

- Assume that composition with T has been defined for all transseries of level N . It is assumed that this composition is a transseries of level $N + m$. Then $L(T) = L_1 + c_1 + s_1$ (it is easily seen that $L(T)$ is not necessarily purely large). Then

$$(x^a e^L) \circ (T) := T^a e^{L(T)} = x^b (1 + s_1(T)) e^{L_1(T)} \tag{4.204}$$

where $L_1(T)$ is purely large. Since L_1 has level $N + m$, then $(x^a e^L) \circ (T)$ has level $N + m + 1$. We have $(e^{L_1})' = L_1' e^{L_1}$ and the chain rule follows by induction and from the sum and product rules.

Exercise 4.205 *If $T^{[n]}$ is a sequence of transseries, then $e^{T^{[n]}}$ is not necessarily a valid sequence of transseries. But if it is, then there is an L_0 such that $L^{[n]} = L_0$ for all large n . If $e^{T^{[n]}}$ is a sequence of transseries and $T^{[n]} \rightarrow 0$, then $e^{T^{[n]}} \rightarrow 1$.*

- In this sense, the exponential is continuous. This follows from Exercise 4.205 and Exercise 4.177.
- Take now a general *large* transseries of level $N + 1$ and write $T = x^a e^L (1 + s)$; let

$$t = \sum_{\mathbf{k} \succeq \mathbf{m}} x^{-\mathbf{k} \cdot \boldsymbol{\alpha}} e^{-\mathbf{k} \cdot \mathbf{1}} \tag{4.206}$$

Then $t(T)$ is well defined as the limit of the following finite sum with generators $x^{-|a\alpha_j|}, x^{-\alpha_j} e^{-l_j(T)}, e^{-l_j(T)}$; $j = 1, \dots, n$:

$$t(T) = \sum_{\mathbf{M}_p \succeq \mathbf{k} \succeq \mathbf{m}} x^{-a(\mathbf{k} \cdot \boldsymbol{\alpha})} e^{-\mathbf{k} \cdot \mathbf{1}_1(T)} (1 + \mathbf{s}(T)) \tag{4.207}$$

- The chain rule holds by continuity.
- The general theory we developed in §4.9 applies and guarantees that the properties listed in §4.10a hold (check!).

4.10b.2 An inequality helpful in WKB analysis

Proposition 4.208 *If $L \gg 1$, then $L'' \ll (L')^2$ (or, which is the same, $L' \ll L^2$).*

PROOF If $L = x^\alpha e^{L_1}$ where $L_1 \neq 0$, then L_1 is purely large, then the dominance of L' is of the form $L_3 e^{L_1}$, with $L_3 \ll e^{L_1}$, whereas the dominance of L is $x^{2\alpha} e^{2L_1}$ and the property is obvious. If $L_1 = 0$ the property is obvious as well. \square

In WKB analysis this result is mostly used in the form (4.210) below.

Exercise 4.209 *Show that if $T \gg 1$, T positive or negative, we have*

$$\text{dom}[(e^T)^{(n)}] = \text{dom}[(T')^n e^T] \quad (4.210)$$

4.10c General logarithmic-free transseries

These are simply defined as

$$\mathcal{T}_e = \bigcup_{N \in \mathbb{N}} \mathcal{T}^{[N]} \quad (4.211)$$

with the natural embeddings.

The general theory we developed in §4.9 applies to \mathcal{T}_e as well. Since any transseries belongs to some level, any finite number of them share some level. There are no operations defined which involve infinitely many levels, because they would involve infinitely many generators. Then, the properties listed in §4.10a hold in \mathcal{T}_e (check!).

4.10d Écalle's notation

- \sqcup —small transmonomial.
- \sqcap —large transmonomial.
- \square —any transmonomial, large or small.
- $\sqcup\sqcup$ —small transseries.
- $\sqcap\sqcap$ —large transseries.
- $\square\square$ —any transseries, small or large.

4.10d.1 Further properties of transseries

Definition. The level $l(T)$ of T is n if $T \in \mathcal{T}^{[n]}$ and $T \notin \mathcal{T}^{[n-1]}$.

4.10d.2 Further properties of differentiation

We denote $\mathcal{D} = \frac{d}{dx}$.

Corollary 4.212 *We have $\mathcal{D}T = 0 \iff T = \text{Const}$.*

PROOF We have to show that if $T = L + s \neq 0$, then $T' \neq 0$. If $L \neq 0$ then for some $\beta > 0$ we have $L + s \gg x^\beta + s$ and then $L' + s' \gg x^{\beta-1} \neq 0$. If instead $L = 0$, then $(1/T) = L_1 + s_1 + c$ and we see that $(L_1 + s_1)' = 0$ which, by the above, implies $L_1 = 0$ which gives $1/s = s_1$, a contradiction. \square

Proposition 4.213 *Assume $T = L$ or $T = s$. Then:*

- (i) *If $l(\text{mag}(T)) \geq 1$, then $l(\text{mag}(T^{-1}T')) < l(\text{mag}(T))$.*
- (ii) *$\text{dom}(T') = \text{dom}(T)'(1 + s)$.*

PROOF Straightforward induction. \square

4.10d.3 Transseries with complex coefficients

Complex transseries $\mathcal{T}_{\mathbb{C}}$ are constructed in a similar way as real transseries, replacing everywhere $L_1 > L_2$ by $\text{Re } L_1 > \text{Re } L_2$. Thus there is only one order relation in $\mathcal{T}_{\mathbb{C}}$, \gg . Difficulties arise when exponentiating transseries whose dominant term is imaginary. Operations with complex transseries are then limited. We will only use complex transseries in contexts that will prevent these difficulties.

4.10d.4 Differential systems in \mathcal{T}_e

The theory of differential equations in \mathcal{T}_e is similar in many ways to the corresponding theory for functions.

Example. The general solution of the differential equation

$$f' + f = 1/x \tag{4.214}$$

in \mathcal{T}_e (for $x \rightarrow +\infty$) is $T(x; C) = \sum_{k=0}^{\infty} k!x^{-k} + Ce^{-x} = T(x; 0) + Ce^{-x}$.

The particular solution $T(x; 0)$ is the unique solution of the equation $f = 1/x - \mathcal{D}f$ which is manifestly contractive in the space of level zero transseries.

Indeed, the fact that $T(x; C)$ is a solution follows immediately from the definition of the operations in \mathcal{T}_e and the fact that e^{-x} is a solution of the homogeneous equation.

To show uniqueness, assume T_1 satisfies (4.214). Then $T_2 = T_1 - T(x; 0)$ is a solution of $\mathcal{D}T + T = 0$. Then $T_2 = e^x T$ satisfies $\mathcal{D}T_2 = 0$, i.e., $T_2 = \text{Const}$.

4.10e The space \mathcal{T} of general transseries

We define

$$\log_n(x) = \underbrace{\log \log \dots \log(x)}_{n \text{ times}} \tag{4.215}$$

$$\exp_n(x) = \underbrace{\exp \exp \dots \exp(x)}_{n \text{ times}} \tag{4.216}$$

$$\tag{4.217}$$

with the convention $\exp_0(x) = \log_0(x) = x$.

We write $\exp(\log x) = x$ and then any log-free transseries can be written as $T(x) = T \circ \exp_n(\log_n(x))$. This defines right composition with \log_n in this trivial case, as $T_1 \circ \log_n(x) = (T_1 \circ \exp_n) \circ \log_n(x) := T(x)$.

More generally, we define \mathcal{T} , the space of general transseries, as a set of formal compositions

$$\mathcal{T} = \{T \circ \log_n : T \in \mathcal{T}_e\}$$

with the algebraic operations and inequalities (symbolized below by \odot) inherited from $\tilde{\mathcal{T}}$ by

$$(T_1 \circ \log_n) \odot (T_2 \circ \log_{n+k}) = [(T_1 \circ \exp_k) \odot T_2] \circ \log_{n+k} \tag{4.218}$$

and using (4.218), differentiation is defined by

$$\mathcal{D}(T \circ \log_n) = x^{-1} \left[\left(\prod_{k=1}^{n-1} \log_k \right)^{-1} \right] (\mathcal{D}T) \circ \log_n$$

Proposition 4.219 *\mathcal{T} is an ordered differential field, closed under restricted composition.*

PROOF Exercise. □

The logarithm of a transseries. This is defined by first considering the case when $T \in \mathcal{T}_e$ and then taking right composition with iterated logs.

If $T = c \operatorname{mag}(T)(1 + s) = cx^a e^L(1 + s)$, then we define

$$\log(T) = \log(\operatorname{mag}(T)) + \log c + \log(1 + s) = a \log x + L + \log c + \log(1 + s) \tag{4.220}$$

where $\log c$ is the usual log, while $\log(1 + s)$ is defined by expansion which we know is well defined on small transseries.

1. If $L \gg 1$ is large, then $\log L \gg 1$ and if $s \ll 1$, then $\log s \gg 1$.

4.10e.1 Integration

Proposition 4.221 \mathcal{T} is closed under integration.

PROOF The idea behind the construction of \mathcal{D}^{-1} is the following: we first find an invertible operator J which is to leading order \mathcal{D}^{-1} ; then the equation for the correction will be contractive. Let $T = \sum_{\mathbf{k} \geq \mathbf{k}_0} \mu^{\mathbf{k}} \circ \log_n$. To unify the treatment, it is convenient to use the identity

$$\int_x T(s) ds = \int_{\log_{n+2}(x)} (T \circ \exp_{n+2})(t) \prod_{j \leq n+1} \exp_j(t) dt = \int_{\log_{n+2}(x)} T_1(t) dt$$

where the last integrand, $T_1(t)$ is a log-free transseries and moreover

$$T_1(t) = \sum_{\mathbf{k} \geq \mathbf{k}_0} c_{\mathbf{k}} \mu_1^{k_1} \cdots \mu_M^{k_M} = \sum_{\mathbf{k} \geq \mathbf{k}_0} c_{\mathbf{k}} e^{-k_1 L_1 - \dots - k_M L_M}$$

It thus suffices to find $\partial^{-1} e^{\pm L}$, where $n = l(L) \geq 1$ where $L > 0$. We analyze the case $\partial^{-1} e^{-L}$, the other one being similar. Then $L \gg x^m$ for any m and thus also $\partial L \gg x^m$ for all m . Therefore, since $\partial e^{-L} = -(\partial L) e^{-L}$ we expect that $\text{dom}(\partial^{-1} e^{-L}) = -(\partial L)^{-1} e^{-L}$ and we look for a Δ so that

$$\partial^{-1} e^{-L} = -\frac{e^{-L}}{\partial L} (1 + \Delta) \tag{4.222}$$

Then Δ should satisfy the equation

$$\Delta = -\frac{\partial^2 L}{(\partial L)^2} - \frac{\partial^2 L}{(\partial L)^2} \Delta + (\partial L)^{-1} \partial \Delta \tag{4.223}$$

Since $s_1 = 1/L'$ and $s_2 = L''/(L')^2$ are small, by Lemma 4.168, there is a set of generators in which all the magnitudes of $s_{1,2}$ are of the form $\mu^{\mathbf{k}}$ with $\mathbf{k} > 0$. By Proposition 4.208 and Exercise 4.199, (4.223) is contractive and has a unique solution in the space of transseries satisfying $\sum c_{\omega} e^{-L_{\omega}} = \Delta \ll L$, and having the complete set of generators of L and x^{-1} and the generators constructed above. For the last term, note that if $\Delta = \sum c_{\omega} e^{-L_{\omega}}$ and $L = e^{-L}$, then $\Delta'/L' = \sum c_{\omega} L'_{\omega} e^{-L_{\omega}} e^{-L_1}$ and $L'_{\omega} e^{-L} = \mu_{\omega} \ll 1$.

□

1. Since the equation is contractive, it follows that $\text{mag}(\Delta) = \text{mag}(L''/L'^2)$.

In the following we also use the notation $\partial T = T'$ and we write \mathcal{P} for the antiderivative ∂^{-1} constructed above.

Proposition 4.224 \mathcal{P} is an antiderivative without constant terms, i.e.,

$$\mathcal{P}T = L + s$$

PROOF This follows from the fact that $\mathcal{P}e^{-L} \ll 1$ while $\mathcal{P}(e^L)$ is purely large, since all small terms are of lower level. Check! □

Proposition 4.225 *We have*

$$\begin{aligned}
 \mathcal{P}(T_1 + T_2) &= \mathcal{P}T_1 + \mathcal{P}T_2 \\
 (\mathcal{P}T)' &= T; \quad \mathcal{P}T' = T_{\bar{0}} \\
 \mathcal{P}(T_1T_2') &= (T_1T_2)_{\bar{0}} - \mathcal{P}(T_1'T_2) \\
 T_1 \gg T_2 &\implies \mathcal{P}T_1 \gg \mathcal{P}T_2 \\
 T > 0 \text{ and } T \gg 1 &\implies \mathcal{P}T > 0
 \end{aligned}
 \tag{4.226}$$

where $T_{\bar{0}}$ is the constant-free part of T :

$$T = \sum_{\mathbf{k} \succeq \mathbf{k}_0} c_{\mathbf{k}} \mu^{\mathbf{k}} \implies T_{\bar{0}} = \sum_{\mathbf{k} \succeq \mathbf{k}_0; \mathbf{k} \neq 0} c_{\mathbf{k}} \mu^{\mathbf{k}}$$

PROOF Exercise. □

There exists only one \mathcal{P} with the properties (4.226), for any two would differ by a constant.

Remark 4.227 *Let $s_0 \in \mathcal{T}$. The operators defined by*

$$J_1(T) = \mathcal{P}(e^{-x}(\text{Const.} + s_0)T(x)) \tag{4.228}$$

$$J_2(T) = e^{\pm x} x^{\sigma} \mathcal{P}(x^{-2} x^{-\sigma} e^{\mp x}(\text{Const.} + s_0)T(x)) \tag{4.229}$$

are contractive on \mathcal{T} .

PROOF For (4.228) it is enough to show contractivity of $\mathcal{P}(e^{-x}\cdot)$. If we assume the contrary, that $T' \ll Te^{-x}$ it follows that $\log T \gg 1$. We know that if $\log T$ is small, then $\text{mag}(T) = c$, c constant. But if $\text{mag}(T) = c$, then the property is immediate. The proof of (4.228) is very similar. □

Exercise 4.230 In Eq. (4.54) let \tilde{y}_0 be a level zero transseries solution, and let $y = y_0 + \delta$ be the general transseries solution. If $\delta'/\delta = L + c + s$, show that $L = 0$ and $c = -1$. Then $\delta = Ce^{-x}(1 + s_1)$. Show that the equation for s_1 is contractive in the space of small transseries of any fixed level.

Chapter 5

Borel summability in differential equations

In §5.3 we look at an ODE example which illustrates some key ingredients needed in a more general analysis. §5.9 contains a number of results which hold for generic systems of differential equations; the proofs, outlined in §5.10 and given in detail (with some simplifying assumptions) in §5.10c rely on methods that can be adapted to other problems.

Using the singularity structure in Borel plane, one can generically reconstruct a system of ODEs from just one, possibly formal, solution, see [Remark 5.75](#).

5.1 Convolutions revisited

We have, see [§2.2a](#),

$$\mathcal{L}[f * g] = (\mathcal{L}f)(\mathcal{L}g) \quad (5.1)$$

Furthermore,

$$\mathcal{L}[f * (g * h)] = \mathcal{L}[f]\mathcal{L}[g * h] = \mathcal{L}[f]\mathcal{L}[g]\mathcal{L}[h] = \mathcal{L}[(f * g) * h] \quad (5.2)$$

and since the Laplace transform is injective, we get

$$f * (g * h) = (f * g) * h \quad (5.3)$$

and convolution is associative. Similarly, it is easy to see that

$$f * g = g * f, \quad f * (g + h) = f * g + f * h \quad (5.4)$$

Some spaces arise naturally and are well suited for the study of convolution equations.

(1) Let $\nu \in \mathbb{R}^+$ and define $L_\nu^1 := \{f : \mathbb{R}^+ : f(p)e^{-\nu p} \in L^1(\mathbb{R}^+)\}$; then the norm $\|f\|_\nu$ is defined as $\|f(p)e^{-\nu p}\|_1$ where $\|\cdot\|_1$ denotes the L^1 norm.

We recall that L^1_ν is a Banach algebra with respect to convolution; see Lemma 4.101.

We see that the norm $\|\cdot\|_\nu$ is the Laplace transform of $|f|$ evaluated at large argument ν , and it is, in this sense, a Borel dual of the sup norm in the original space.

(2) We say that f is in $L^1_\nu(\mathbb{R}^+e^{i\phi})$ if $f_\phi(t) := f(te^{-i\phi}) \in L^1_\nu$. Convolution along $\mathbb{R}^+e^{i\phi}$ reads

$$(f * g)(|p|e^{i\phi}) = \int_0^{|p|e^{i\phi}} f(s)g(|p|e^{i\phi} - s)ds = e^{i\phi} \int_0^{|p|} f(te^{i\phi})g(e^{i\phi}(|p| - t))dt = e^{i\phi}(f_\phi * g_\phi)(|p|) \quad (5.5)$$

It is clear that $L^1_\nu(\mathbb{R}^+e^{i\phi})$ is also a Banach algebra with respect to convolution.

(3) Similarly, we say that $f \in L^1_\nu(S)$ where $S = \{te^{i\phi} : t \in \mathbb{R}^+, \phi \in (a, b)\}$ if $f \in L^1_\nu(\mathbb{R}^+e^{i\phi})$ for all $\phi \in (a, b)$. We define $\|f\|_{\nu,S} = \sup_{\phi \in (a,b)} \|f\|_{L^1_\nu(\mathbb{R}^+e^{i\phi})}$. The space $L^1_\nu(S) = \{f : \|f\|_{\nu,S} < \infty\}$ is also a Banach algebra.

(4) The L^1_ν spaces can be restricted to an initial interval along a ray, or a compact subset of S , restricting the norm to an appropriate set. For instance,

$$L^1_\nu([0, 1]) = \left\{ f : \int_0^1 e^{-\nu s} |f(s)| ds < \infty \right\} \quad (5.6)$$

These spaces are Banach algebras as well. Obviously, if $A \subset B$, $L^1_\nu(B)$ is naturally embedded (cf. footnote 2 on p. 148) in $L^1_\nu(A)$.

(5) Another important space is $\mathcal{A}_{K,\nu}(\mathcal{E})$, the space of analytic functions in a star-shaped¹ neighborhood \mathcal{E} of the disk $\{p : |p| \leq K\}$ in the norm ($\nu \in \mathbb{R}^+$)

$$\|f\| = K \sup_{p \in \mathcal{E}} \left| e^{-\nu|p|} f(p) \right|$$

Note. This norm is topologically equivalent with the sup norm (convergent sequences are the same), but better behaved for finding exponential bounds.

Proposition 5.7 *The space $\mathcal{A}_{K,\nu}$ is a Banach algebra with respect to convolution.*

PROOF Analyticity of convolution is proved in the same way as Lemma 4.101. For continuity we let $|p| = P$, $p = Pe^{i\phi}$ and note that

¹Containing every point p together with the segment linking it to 0.

$$\begin{aligned} \left| K e^{-\nu P} \int_0^P f(s)g(p-s)ds \right| &= \left| K e^{-\nu P} \int_0^P f(te^{i\phi})g((P-t)e^{i\phi})dt \right| \\ &= \left| K^{-1} \int_0^P K f(te^{i\phi})e^{-\nu t} K g((P-t)e^{i\phi})e^{-\nu(P-t)}dt \right| \\ &\leq K^{-1} \|f\| \|g\| \int_0^K dt = \|f\| \|g\| \end{aligned} \tag{5.8}$$

□

Note that $\mathcal{A}_{K;\nu} \subset L^1_\nu(\mathcal{E})$.

(6) Finally, we note that the space $\mathcal{A}_{K;\nu;0}(\mathcal{E}) = \{f \in \mathcal{A}_{K;\nu}(\mathcal{E}) : f(0) = 0\}$ is a closed subalgebra of $\mathcal{A}_{K;\nu}$.

Remark 5.9 *In the spaces L^1_ν , $\mathcal{A}_{K;\nu}$, $\mathcal{A}_{K;\nu;0}$, etc. we have, for a bounded function f ,*

$$\|fg\| \leq \|g\| \max |f|$$

5.1a Spaces of sequences of functions

In Borel summing more general transseries, it is convenient to look at sequences of vector-valued functions belonging to one or more of the spaces introduced before. We let

$$\mathbf{y} = \{\mathbf{y}_k\}_{k \succ 0}; \quad \mathbf{k} \in \mathbb{Z}^m, \mathbf{y}_k \in \mathbb{C}^n \tag{5.10}$$

(for the order relation \succ on \mathbb{Z}^m and §4.9 or §5.8b) and similarly

$$\mathbf{Y} = \{\mathbf{Y}_k\}_{k \succ 0} \tag{5.11}$$

For instance if $m = 1$ we define

$$L^1_{\nu,\mu} = \{\mathbf{Y} \in (L^1_\nu)^\mathbb{N} : \sum_{k=1}^\infty \mu^{-k} \|\mathbf{Y}_k\|_\nu < \infty\} \tag{5.12}$$

and introduce the following convolution on $L^1_{\nu,\mu}$

$$(\mathbf{F} * \mathbf{G})_k = \sum_{j=1}^{n-1} \mathbf{F}_j * \mathbf{G}_{k-j} \tag{5.13}$$

Exercise 5.14 *Show that*

$$\|\mathbf{F} * \mathbf{G}\|_{\nu,\mu} \leq \|\mathbf{F}\|_{\nu,\mu} \|\mathbf{G}\|_{\nu,\mu} \tag{5.15}$$

and $(L^1_{\nu,\mu}, +, *, \|\cdot\|_{\nu,\mu})$ is a Banach algebra.

5.2 Focusing spaces and algebras

An important property of the norms (1)–(4) and (6) in §5.1 is that for any f we have $\|f\|_\nu \rightarrow 0$ as $\nu \rightarrow \infty$. For L^1_ν for instance this is an immediate consequence of dominated convergence.

A family of norms $\|\cdot\|_\nu$ depending on a parameter $\nu \in \mathbb{R}^+$ is **focusing** if for any f with $\|f\|_{\nu_0} < \infty$ for some ν_0 we have

$$\|f\|_\nu \downarrow 0 \text{ as } \nu \uparrow \infty \tag{5.16}$$

(\downarrow means monotonically decreasing to the limit, \uparrow means increasing). We note that norms can only be focusing in Banach algebras *without* identity, since $\|I\| \leq \|I\|\|I\|$ implies $\|I\| \geq 1$.) Focusing norms, when they exist, are quite useful; for instance, for ν large enough, nonlinear terms in an equation are arbitrarily small.

Let \mathcal{V} be a linear space and $\{\|\cdot\|_\nu\}$ a family of norms satisfying (5.16). For each ν we define a Banach space \mathcal{B}_ν as the completion of $\{f \in \mathcal{V} : \|f\|_\nu < \infty\}$. Enlarging \mathcal{V} if needed, we may assume that $\mathcal{B}_\nu \subset \mathcal{V}$. For $\alpha < \beta$, (5.16) shows \mathcal{B}_α is naturally embedded in \mathcal{B}_β .² Let $\mathcal{F} \subset \mathcal{V}$ be the projective limit of the \mathcal{B}_ν . That is to say

$$\mathcal{F} := \bigcup_{\nu > 0} \mathcal{B}_\nu \tag{5.17}$$

where a sequence is convergent if it converges in *some* \mathcal{B}_ν . We call \mathcal{F} a **focusing space**.

Consider now the case when $(\mathcal{B}_\nu, +, *, \|\cdot\|_\nu)$ are commutative Banach algebras. Then \mathcal{F} inherits a structure of a commutative algebra, in which $*$ is continuous. We say that $(\mathcal{F}, *, \|\cdot\|_\nu)$ is a **focusing algebra**.

Examples. The spaces $\bigcup_{\nu > 0} L^1_\nu$ and $\bigcup_{\nu > 0} \mathcal{A}_{K;\nu;0}$ and $L^1_{\nu,\mu}$ are focusing algebras. The last space is focusing as $\nu \rightarrow \infty$ and/or $\mu \rightarrow \infty$.

An extension to distributions, very useful in studying singular convolution equations, is the space of staircase distributions $\mathcal{D}'_{m,\nu}$; see §5.12.

Remark 5.18 The following observation is immediate. Let S_1, S_2 be any sets, f defined on $S_1 \cup S_2$, and assume that the equation $f(x) = 0$ has a unique solution x_1 in S_1 , a unique solution x_2 in S_2 and a unique solution x_3 in $S_1 \cap S_2$. Then $x_1 = x_2 = x_3 \in S_1 \cap S_2$. This is useful when we want to show that one solution has a number of different properties: analyticity, boundedness, etc. and we do not want to complicate the norms. See e.g. [Proposition 5.20](#) below.

²That is, we can naturally identify \mathcal{B}_α with a subset of \mathcal{B}_β which is isomorphic to it.

5.3 Example: Borel summation of the formal solutions to (4.54)

5.3a Borel summability of the asymptotic series solution

Since we have a Banach algebra structure in Borel plane, differential equations become effectively algebraic equations (with multiplication represented by $*$), much easier to deal with.

The analysis of (4.54) captures some important part of what is needed in a general setting. Its formal inverse Laplace is

$$-pY + Y = p + Y^{*3}; \Leftrightarrow Y = \frac{p}{1-p} + \frac{1}{1-p}Y^{*3} := \mathcal{N}(Y) \tag{5.19}$$

where $\mathcal{L}^{-1}y = Y$ and $Y^{*3} = Y * Y * Y$.

Let $[a, b] \subset (0, 2\pi)$, and $S = \{p : \arg(p) \in (a, b)\}$, $S_K = \{p \in S : |p| < K\}$, $B = \{p : |p| < a < 1\}$.

Proposition 5.20 (i) For large enough ν , (5.19) has a unique solution Y_0^+ in the following spaces: $L_\nu^1(S), L_\nu^1(S_K), \mathcal{A}_{\nu,0}(S_K \cup B)$. (ii) The solution Y_0^+ is thus analytic in $S \cup B$ and Laplace transformable along any direction in S . The Laplace transform is a solution of (4.54). A similar result holds if $(a, b) \subset (-2\pi, 0)$; we denote that solution by Y_0^- .

Note 5.21 By uniqueness, $Y_0^+ = Y_0^- = Y_0$ in B ; then Y_0^+ (Y_0^-) are simply the continuations of Y_0 in the upper (lower, respectively) half-plane. As we will see, in general $Y_0(p)$ has singularities at $p = 1, 2, \dots$, and the limiting values of Y_0^\pm on $(0, \infty)$, when they exist, do not coincide.

PROOF The proof is the same for all these spaces, since they generate focusing algebras. (i) Choose ϵ small enough. Then for large enough ν we have

$$\left\| \frac{p}{1-p} \right\|_\nu < \epsilon/2 \tag{5.22}$$

Let \mathfrak{B} be the ball of radius ϵ in the norm ν . Then if $F \in \mathfrak{B}$ we have

$$\|\mathcal{N}(F)\|_\nu \leq \left\| \frac{p}{1-p} \right\|_\nu + \max \left| \frac{1}{p-1} \right| \|Y\|_\nu^3 = \epsilon/2 + c\epsilon^3 \leq \epsilon \tag{5.23}$$

if ϵ is small enough (that is, if ν is large). Furthermore, for large ν , \mathcal{N} is contractive in \mathfrak{B} for we have, for small ϵ ,

$$\begin{aligned} \|\mathcal{N}(F_1) - \mathcal{N}(F_2)\|_\nu &\leq c\|F_1^{*3} - F_2^{*3}\|_\nu = c\|(F_1 - F_2) * (F_1^{*2} + F_1 * F_2 + F_2^{*2})\|_\nu \\ &\leq c\|(F_1 - F_2)\|_\nu(3\epsilon^2) < \epsilon \end{aligned} \tag{5.24}$$

(ii) We have the following embeddings: $L_\nu^1(S) \subset L_\nu^1(S_K), \mathcal{A}_{\nu,0}(S_K \cup B) \subset L_\nu^1(S_K)$. Thus, by Remark 5.18, there exists a unique solution Y of (5.19) which belongs to all these spaces.

Thus Y is analytic in S and belongs to $L_\nu^1(S)$, in particular it is Laplace transformable. The Laplace transform is a solution of (4.54) as it is easy to check.

It also follows that the formal power series solution \tilde{y} of (4.54) is Borel summable in any sector not containing \mathbb{R}^+ , which is a Stokes ray. We have, indeed, $\mathcal{B}\tilde{y} = Y$ (check!). □

5.3b Borel summation of the transseries solution

If we substitute

$$\tilde{y} = \tilde{y}_0 + \sum_{k=1}^{\infty} C^k e^{-kx} \tilde{y}_k \tag{5.25}$$

in (4.54) and equate the coefficients of e^{-kx} we get the system of equations

$$\tilde{y}'_k + (1 - k - 3\tilde{y}_0^2)\tilde{y}_k = 3\tilde{y}_0 \sum_{j=1}^{k-1} \tilde{y}_j \tilde{y}_{k-j} + \sum_{j_1+j_2+j_3=k; j_i \geq 1} \tilde{y}_{j_1} \tilde{y}_{j_2} \tilde{y}_{j_3} \tag{5.26}$$

The equation for \tilde{y}_1 is linear and homogeneous:

$$\tilde{y}'_1 = 3\tilde{y}_0^2 \tilde{y}_1 \tag{5.27}$$

Thus

$$\tilde{y}_1 = C e^{\tilde{s}}; \quad \tilde{s} := \int_{\infty}^x 3\tilde{y}_0^2(t) dt \tag{5.28}$$

Since $\tilde{s} = O(x^{-3})$ is the product of Borel summable series (in $\mathbb{C} \setminus \mathbb{R}^+$), then, by Proposition 4.109, $e^{\tilde{s}}$ is Borel summable in $\mathbb{C} \setminus \mathbb{R}^+$. We note that $\tilde{y}_1 = 1 + o(1)$ and we cannot take the inverse Laplace transform of \tilde{y}_1 directly. But the series $x^{-1}\tilde{y}_1$ is Borel summable (say to $\check{\Phi}_1$) see Proposition 4.109. It is convenient to make the substitution $\tilde{y}_k = x^k \tilde{\varphi}_k$. We get

$$\tilde{\varphi}'_k + (1 - k - 3\tilde{\varphi}_0^2 + kx^{-1})\tilde{\varphi}_k = 3\tilde{\varphi}_0 \sum_{j=1}^{k-1} \tilde{\varphi}_j \tilde{\varphi}_{k-j} + \sum_{j_1+j_2+j_3=k; j_i \geq 1} \tilde{\varphi}_{j_1} \tilde{\varphi}_{j_2} \tilde{\varphi}_{j_3} \tag{5.29}$$

where clearly $\tilde{\varphi}_0 = \tilde{y}_0, \tilde{\varphi}_1 = x^{-1}\tilde{y}_1$, with \tilde{y}_1 given in (5.28). After Borel transform, we have

$$-p\Phi + (1 - \hat{k})\Phi = -\hat{k} * \Phi + 3Y_0^{*2} * \Phi + 3Y_0 * \Phi * \Phi + \Phi * \Phi * \Phi \tag{5.30}$$

where $\Phi = \{\Phi_j\}_{j \in \mathbb{N}}, (\hat{k}\Phi)_k = k\Phi_k$ and $(F * G)_k := F * G_k$.

Here $\Phi_0 (= Y_0)$ and $\Phi_1 = \check{\Phi}_1$ have already been determined. We replace them by these values, or by $Y_0^\pm, \check{\Phi}_1^\pm$ when working in sectors in the upper

or lower half-plane and treat (5.30), modified in this way, as an equation in $L^1_{\mu,\nu;1} \subset L^1_{\mu,\nu}$, the subspace of sequences $\{\Phi_j\}_{j \in \mathbb{N}}$, $\Phi_1 = 0$ (and similar subspaces of other focusing algebras).

Proposition 5.31 (i) For any μ , if ν is large enough, (5.30) is contractive in $L^1_{\nu,\mu;1}(S)$. Thus (5.30) has a unique solution Φ^+ in this space. Similarly, it has a unique solution in $L^1_{\nu,\mu;1}(S)$ and $\mathcal{A}_{\nu,\mu;1}(S_K)$ for any S and S_K as in Proposition 5.20. Likewise, there is a unique solution Φ^- in the corresponding spaces in the lower half-plane³.

(ii) Thus there is a ν large enough so that for all k

$$\varphi_k^-(x) = \int_0^\infty e^{+i \arg(x)} e^{-xp} \Phi_k^+(p) dp \tag{5.32}$$

exist for $|x| > \nu$. The functions $\varphi_k(x)^-$ are analytic in x , for $\arg(x) \in (-2\pi - \pi/2, \pi/2)$, where we take $\Phi_0^+ = Y_0^+$ and $\Phi_1^+ = \check{\Phi}_1^+$. The similarly obtained $\varphi_k(x)^+$ are analytic in x , $\arg(x) \in (-\pi/2, 2\pi + \pi/2)$. (For higher order equations, these intervals are smaller.)

(iii) The function series

$$y^+(x; C_+) = \sum_{k=0}^\infty C_+^k e^{-kx} x^k \varphi_k^+(x) \tag{5.33}$$

and

$$y^-(x; C_-) = \sum_{k=0}^\infty C_-^k e^{-kx} x^k \varphi_k^-(x) \tag{5.34}$$

converge for sufficiently large $\operatorname{Re} x$, $\arg(x) \in (-\pi/2, \pi/2)$ and solve (4.54). (See also Proposition 5.36 below.)

Note. The solution cannot be written in the form (5.33) or (5.34) in a sector of opening more than π centered on \mathbb{R}^+ because the exponentials would become large and convergence is not ensured anymore. This, generically, implies blow-up of the actual solutions; see §6.

Exercise 5.35 (*) Prove Proposition 5.31.

Proposition 5.36 Any solution of (4.54) which is $o(1)$ as $x \rightarrow +\infty$ can be written in the form (5.33) or, equally well, in the form (5.34).

PROOF Let $y_0 := y^+$ be the solution of (4.54) of the form (5.33) with $C = 0$. Let y be another solution which is $o(1)$ as $x \rightarrow +\infty$ and let $\delta = y - y^+$. We have

$$\delta' = -\delta + 3y_0^2\delta + 3y_0\delta^2 + \delta^3 \tag{5.37}$$

³Like Y_0 , the functions Φ_k are analytic for $|p| < 1$, but generally have branch points at $1, 2, \dots$

or

$$\frac{\delta'}{\delta} = -1 + 3y_0^2 + 3y_0\delta + \delta^2 = -1 + o(1) \tag{5.38}$$

Thus (since we can integrate asymptotic relations),

$$\ln \delta = -x + o(x) \tag{5.39}$$

and thus

$$\delta = e^{-x+o(x)}$$

Returning to (5.38), we see that

$$\frac{\delta'}{\delta} = -1 + 3y_0^2 + 3y_0\delta + \delta^2 = -1 + O(1/x^2) \tag{5.40}$$

or

$$\delta = Ce^{-x}(1 + o(1)) \tag{5.41}$$

We then take $\delta = Ce^{-x+s}$ and obtain

$$s' = 3y_0^2 + 3y_0e^{-x+s} + e^{-2x+2s} \tag{5.42}$$

where s is small, or,

$$s = C + \int_{\infty}^x \left(3y_0^2(t) + 3y_0(t)e^{-x+s(t)} + e^{-2t+2s(t)} \right) dt \tag{5.43}$$

Eq. (5.43) is contractive in the space of bounded, continuous functions $s : [\nu, \infty) \mapsto \mathbb{C}$ in the sup norm. The solution of this equation is then unique. But $s = \ln(y_1 - y^+) + x$ where y_1 is the solution of the form (5.33) with $C_+ = C$ is already a solution of (5.43), so they must coincide. \square

5.3c Analytic structure along \mathbb{R}^+

The approach sketched in this section is simple, but of limited scope as it relies substantially on the ODE origin of the convolution equations.

A different, complete proof, that uses the differential equation only minimally is given in §5.10c.

*

By Proposition 5.20, $Y = Y_0^+$ is analytic in any region of the form $B \cup S_K$. We now sketch a proof that Y_0 has analytic continuation along curves that do not pass through the integers.

For this purpose we use (5.33) and (5.34) in order to derive the behavior of Y . It is a way of exploiting what Écalle has discovered in more generality, *bridge equations*.

We start with exploring a relatively trivial, nongeneric possibility, namely that $y_0^+ = y_0^- =: y_0$. (This is not the case for our equation, though we will not

prove it here; we still analyze this case since it may occur in other equations.) Since in this case

$$y_0^\pm = \int_0^{\infty e^{\pm i\epsilon}} Y(p)e^{-px} dp = y_0 \tag{5.44}$$

we have $y \sim \tilde{y}_0$ in a sector of arbitrarily large opening. By inverse Laplace transform arguments, Y is analytic in an arbitrarily large sector in $\mathbb{C} \setminus \{0\}$. On the other hand, we already know that Y is analytic at the origin, and it is thus entire, of exponential order at most one. Then, \tilde{y}_0 converges.

Exercise 5.45 Complete the details in the argument above.

We now consider the generic case $y^+ \neq y^-$. Then there exists $S \neq 0$ so that

$$y^+ = \int_0^{\infty e^{i\epsilon}} e^{-px} Y^+(p) dp = y^- + \sum_{k=1}^{\infty} S^k e^{-kx} x^k \varphi_k^-(x) \tag{5.46}$$

Thus

$$\int_{\infty e^{-i\epsilon}}^{\infty e^{+i\epsilon}} e^{-px} Y(p) dp = \int_1^{\infty} e^{-px} (Y^+(p) - Y^-(p)) dp = \sum_{k=1}^{\infty} S^k e^{-kx} x^k \varphi_k^-(x) \tag{5.47}$$

In particular, we have (since $\phi^\pm = \phi$ for $|p| < 1$)

$$\begin{aligned} \frac{1}{x} \int_1^{\infty} e^{-px} (Y^+(p) - Y^-(p)) dp &= S e^{-x} \int_0^{\infty e^{-i\epsilon}} e^{-px} \varphi_1(p) dp + O(x^2 e^{-2x}) \\ &= S \int_1^{\infty e^{-i\epsilon}} e^{-px} \varphi_1(p-1) dp + O(x^2 e^{-2x}) \end{aligned} \tag{5.48}$$

Then, by Proposition 2.22, $\int_0^p Y^+ = \int_0^p Y^- + S\varphi_1(p-1)$ on $(1, 2)$. (It can be checked that $\int Y$ has lateral limits on $(1, 2)$, by looking at the convolution equation in a focusing space of functions continuous up to the boundary.)

Since φ_1 is continuous, this means $\int_0^p Y^+ = S\varphi_1(p-1) + \int_0^p Y^-$ or $Y^+ = Y^- + S Y_1(p-1)$, or yet, $Y^+(1+s) = Y^-(1+s) + S Y_1(s)$ everywhere in the right half s plane where $Y^- - Y_1$ is analytic, in particular in the fourth quadrant. Thus the analytic continuation of Y from the upper plane along a curve passing between 1 and 2 exists in the lower half-plane; it equals the continuation of two functions along a straight line not crossing any singularities. The proof proceeds by induction, reducing the number of crossings at the expense of using more of the functions Y_2, Y_3, \dots

This analysis can be adapted to general differential equations, and it allows for finding the resurgence structure (singularities in p) by constructing and solving Riemann-Hilbert problems, in the spirit above.

5.4 General setting

By relatively simple algebraic transformations a higher order differential equation can be transformed into a first order vectorial equation (differential system) and vice versa [16]. The vectorial form has some technical advantages.

We consider the differential system

$$\mathbf{y}' = \mathbf{f}(x, \mathbf{y}) \quad \mathbf{y} \in \mathbb{C}^n \quad (5.49)$$

under the following *assumptions*:

(a1) The function \mathbf{f} is analytic at $(\infty, 0)$.

(a2) A condition of nonresonance holds: the numbers $\arg \lambda_i$, $i = 1, \dots, n$ are *distinct*, where λ_i , all nonzero, are the eigenvalues of the linearization

$$\hat{\Lambda} := - \left(\frac{\partial f_i}{\partial y_j}(\infty, 0) \right)_{i,j=1,2,\dots,n} \quad (5.50)$$

In the complete transseries analysis we impose a stronger condition (see §5.6a). Writing out explicitly a few terms in the expansion of \mathbf{f} , relevant to leading order asymptotics, we get

$$\mathbf{y}' = \mathbf{f}_0(x) - \hat{\Lambda} \mathbf{y} + \frac{1}{x} \hat{A} \mathbf{y} + \mathbf{g}(x, \mathbf{y}) \quad (5.51)$$

where \mathbf{g} is analytic at $(\infty, \mathbf{0})$ where $\mathbf{g}(x, \mathbf{y}) = O(x^{-2}, |\mathbf{y}|^2, x^{-2} \mathbf{y})$.

5.5 Normalization procedures: An example

Many equations that are not presented in the form (5.51) can be brought to this form by changes of variables. The key idea for so doing in a systematic way is to calculate the transseries solutions of the equation, find the transformations which bring the transseries to the normal form (5.63), and then apply the same transformations to the differential equation. The first part of the analysis need not be rigorous, as the conclusions are made rigorous in the steps that follow it.

We illustrate this on a simple equation

$$u' = u^3 - t \quad (5.52)$$

in the limit $t \rightarrow +\infty$. This is not of the form (5.51) because $g(u, t) = u^3 - t$ is not analytic in t at $t = \infty$. However, this can be remedied in the way described.

As we have already seen, dominant balance for large t requires writing the equation (5.52) in the form

$$u = (t + u')^{1/3} \tag{5.53}$$

and we have $u' \ll t$. Three branches of the cubic root are possible and are investigated similarly, but we aim here merely at illustration and choose the simplest. Iterating (5.53) in the usual way, we are led to a formal series solution in the form

$$\tilde{u} = t^{1/3} + \frac{1}{9}t^{-4/3} + \dots = t^{1/3} \sum_{k=0}^{\infty} \frac{c_k}{t^{5k/3}} \tag{5.54}$$

To find the full transseries, we now substitute $u = \tilde{u} + \delta$ in (5.52) and keep the dominant terms. We get

$$\frac{\delta'}{\delta} = \left(\frac{9}{5}t^{5/3} + \frac{2}{3} \ln t \right)'$$

from which it follows that

$$\delta = Ct^{2/3} e^{\frac{9}{5}t^{5/3}} \tag{5.55}$$

Since exponents in a normalized transseries solution are linear in the (normalized) variable, the critical time is $t^{5/3}$. We take $x = (At)^{5/3}$; the formal power series (5.54) takes the form

$$\tilde{u} = x^{1/5} \sum_{k=0}^{\infty} \frac{c_k}{x^k} \tag{5.56}$$

But the desired form is $\sum_{k=0}^{\infty} \frac{b_k}{x^k}$. Thus the appropriate dependent variable is $h = Bx^{1/5}u$. The choice of A and B is made so as to simplify the final analysis. We choose $A = -B^2/5, 15/B^5 = -1/9$ and we are led to the equation

$$h' + \frac{1}{5x}h + 3h^3 - \frac{1}{9} = 0 \tag{5.57}$$

which is analytic at infinity, as expected. The only remaining transformation is to subtract a few terms out of h , to make the nonlinearity formally small. This is done by calculating, again by dominant balance, the first two terms in the $1/x$ power expansion of h , namely $1/3 - x^{-1}/15$ and subtracting them out of h , i.e., changing to the new dependent variable $y = h - 1/3 + x^{-1}/15$. This yields

$$y' = -y + \frac{1}{5x} y + g(y, x^{-1}) \tag{5.58}$$

where

$$g(y, x^{-1}) = -3(y^2 + y^3) + \frac{3y^2}{5x} - \frac{1}{15x^2} - \frac{y}{25x^2} + \frac{1}{3^2 5^3 x^3} \tag{5.59}$$

5.6 Further assumptions and normalization

Under the assumptions (a1) and (a2), $\hat{\Lambda}$ in (5.51) can be diagonalized by a linear change of the dependent variable \mathbf{y} . It can be checked that by a further substitution of the form $\mathbf{y}_1 = (I + x^{-1}\hat{V})\mathbf{y}$, the new matrix \hat{A} can be arranged to be diagonal. No assumptions on \hat{A} are needed in this second step. See also §5.11c and [58]. Thus, without loss of generality we can suppose that the system is already presented in *prepared* form, meaning:

- (n1) $\hat{\Lambda} = \text{diag}(\lambda_i)$ and
- (n2) $\hat{A} = \text{diag}(\alpha_i)$

For convenience, we rescale x and reorder the components of \mathbf{y} so that

- (n3) $\lambda_1 = 1$, and, with $\phi_i = \arg(\lambda_i)$, we have $\phi_i \leq \phi_j$ if $i < j$.

A substitution of the form $\mathbf{y} = \mathbf{y}_1 x^{-N}$ for some $N \geq 0$ ensures that

- (n4) $\text{Re}(\alpha_j) > 0, j = 1, 2, \dots, n$.

Note 5.60 The case $\text{Re}(\alpha_j) < 0$ treated in [25] and §5.10c is simpler but it cannot be arranged by simple transformations, while the general case (n4) is dealt with in [23]; in both papers the notation is slightly different:

$$\hat{B} := -\hat{A} \text{ and } \beta := -\alpha \tag{5.61}$$

Finally, through a transformation of the form $\mathbf{y} \leftrightarrow \mathbf{y} - \sum_{k=1}^M \mathbf{a}_k x^{-k}$ and $\mathbf{y} \leftrightarrow (1 + \hat{A}_1 x^{-1} + \dots + \hat{A}_{M+1} x^{-M-1})\mathbf{y}$ we arrange that⁴

- (n5) $\mathbf{f}_0 = O(x^{-M-1})$ and $\mathbf{g}(x, \mathbf{y}) = O(\mathbf{y}^2, x^{-M-1}\mathbf{y})$. We choose $M > 1 + \max_i \text{Re}(\alpha_i)$ (cf. (n2)).

5.6a Nonresonance

For any $\theta > 0$, denote by \mathbb{H}_θ the open half-plane centered on $e^{i\theta}$. Consider the eigenvalues contained in \mathbb{H}_θ , written as a vector $\boldsymbol{\lambda} = (\lambda_{i_1}, \dots, \lambda_{i_{n_1}})$; for these λ s we have $\arg \lambda_{i_j} - \theta \in (-\pi/2, \pi/2)$.

⁴This latter transformation is omitted in [23].

We require that for all θ , the numbers in the finite set

$$\{N_{j,\mathbf{k}} = \lambda_j - \mathbf{k} \cdot \tilde{\boldsymbol{\lambda}} : N_{j,\mathbf{k}} \in \mathbb{H}_\theta, \mathbf{k} \in \mathbb{N}^{n_1}, j = i_1, \dots, i_{n_1}\} \tag{5.62}$$

have distinct complex arguments.

Let $d_{j,\mathbf{k}}$ be the direction of $N_{j,\mathbf{k}}$, that is the set $\{z : \arg z = \arg(-N_{j,\mathbf{k}})\}$. We note that the opposite directions, $-d_{j,\mathbf{k}}$ are Stokes rays (Stokes directions⁵), rays along which the Borel transforms are singular.

It can be easily seen that the set of $\boldsymbol{\lambda}$ which satisfy (1) and (2) has full measure; see also [23].

5.6b The transseries solution of (5.51)

After normalization, the general small (complex) transseries solution of (5.51) on \mathbb{R}^+ , is

$$\tilde{\mathbf{y}} = \sum_{\mathbf{k} \in \mathbb{N}^n} \mathbf{C}^{\mathbf{k}} e^{-\boldsymbol{\lambda} \cdot \mathbf{k} x} x^{\boldsymbol{\alpha} \cdot \mathbf{k}} \tilde{\mathbf{y}}_{\mathbf{k}}(x) = \tilde{\mathbf{y}}_0 + \sum_{\mathbf{k} \geq 0; |\mathbf{k}| > 0} C_1^{k_1} \dots C_n^{k_n} e^{-(\mathbf{k} \cdot \boldsymbol{\lambda}) x} x^{\mathbf{k} \cdot \boldsymbol{\alpha}} \tilde{\mathbf{y}}_{\mathbf{k}} \tag{5.63}$$

which is valid in fact, more generally, in a region where the condition

$$(c1) \quad |C_i e^{-\lambda_i x} x^{\alpha_i}| \ll 1$$

is satisfied. That is, $\arg(x) + \phi_i \in (-\pi/2, \pi/2)$ for all i such that $C_i \neq 0$. This condition needs to be imposed for nonlinear systems, but *not* for linear ones. See also (6.1) and comments following it. Details on the construction are given in §5.11b. Transseries along other directions are constructed as above, after rotating x in (5.51).

Here $\tilde{\mathbf{y}}_{\mathbf{k}}$ are integer power series determined as in §4.2; see also [23]. With different notations (5.63) has been known since the 1920's; see e.g., [58].

5.7 Overview of results

The results are formulated considering that $x \rightarrow \infty$ along \mathbb{R}^+ , or, more generally, in regions in the right half-plane. For other directions, one simply rotates x first.

The results are informally summarized as follows.

- (i) All $\tilde{\mathbf{y}}_{\mathbf{k}}$ are BE summable⁶ in a common half-plane, of the form $H_{x_0} = \{x : \text{Re}(x) > x_0\}$.

⁵They are sometimes called Stokes lines, and often, in older literature, antistokes lines...

⁶Due to special properties of this ODE setting, the process used here is simpler than, but equivalent to, BE summation.

(ii) The Borel sums $\mathbf{y}_{\mathbf{k}} = \mathcal{LB}\tilde{\mathbf{y}}_{\mathbf{k}}$ are analytic in H_{x_0} .

(iii) There exists a vector constant \mathbf{c} independent of \mathbf{k} so that $\sup_{x \in H_{x_0}} |\mathbf{y}_{\mathbf{k}}| \leq \mathbf{c}^{\mathbf{k}}$. Thus, the new series,

$$\mathbf{y} = \sum_{\mathbf{k} \in \mathbb{N}^n} \mathbf{C}^{\mathbf{k}} e^{-\lambda \cdot \mathbf{k}x} x^{\alpha \cdot \mathbf{k}} \mathbf{y}_{\mathbf{k}}(x) \quad (5.64)$$

is convergent for any \mathbf{C} in a region given by the condition $|C_i e^{-\lambda_i x} x^{\alpha_i}| < c_i^{-1}$ (remember that C_i is zero if $|e^{-\lambda_i x}|$ is not small).

(iv) The function \mathbf{y} obtained in this way is a solution of the differential equation (5.51).

(v) Any solution of the differential equation (5.51) which tends to zero along \mathbb{R}^+ can be written, in a direction d in \mathbb{H} , in the form (5.64) for a unique \mathbf{C} , this constant depending usually on the sector where d is (Stokes phenomenon).

(vi) The BE summation operator \mathcal{LB} is the usual Borel summation in any direction d of x which is not a Stokes ray. However \mathcal{LB} is still an isomorphism, whether d is a Stokes direction or not.

5.8 Further notation

We introduce some extra notation for describing special paths and Riemann surfaces that are needed in the construction.

5.8a Regions in the p plane

Consider the prepared system (5.51) under the assumptions of §5.6. Let

$$\mathcal{W} = \{p \in \mathbb{C} : p \neq k\lambda_i, \forall k \in \mathbb{N}^+, i = 1, 2, \dots, n\} \quad (5.65)$$

The function \mathbf{Y}_0 turns out to be analytic in \mathcal{W} . The Stokes directions of $\tilde{\mathbf{y}}_0$ are $d_j = \{p : \arg(p) = -\phi_j\}, j = 1, 2, \dots, n$. The rays $\{p : \arg(p) = \phi_j\}, j = 1, 2, \dots, n$ are singular for \mathbf{Y}_0 , and we simply speak of them as singular rays.

We construct the surface \mathcal{R} , consisting in homotopy classes⁷ of smooth curves in \mathcal{W} starting at the origin, moving away from it, and crossing at most one singular line, at most once (see Fig. 5.1):

$$\mathcal{R} := \left\{ \gamma : (0, 1) \mapsto \mathcal{W} : \gamma(0_+) = 0; \frac{d}{dt} |\gamma(t)| > 0; \frac{d}{dt} \arg(\gamma(t)) \text{ monotonic} \right\}$$

(modulo homotopies) (5.66)

Define $\mathcal{R}_1 \subset \mathcal{R}$ by (5.66) with the supplementary restriction $\arg(\gamma) \in (\psi_n - 2\pi, \psi_2)$ where $\psi_n = \max\{-\pi/2, \phi_n - 2\pi\}$ and $\psi_2 = \min\{\pi/2, \phi_2\}$.

\mathcal{R}_1 may be viewed as the part of \mathcal{R} constructed over a sector containing \mathbb{R}^+ .

Similarly we let $\mathcal{R}'_1 \subset \mathcal{R}_1$ with the restriction that the curves γ do not cross any singular direction *other* than \mathbb{R}^+ , and we let $\psi_{\pm} = \pm \max(\pm \arg \gamma)$ with $\gamma \in \mathcal{R}'_1$.

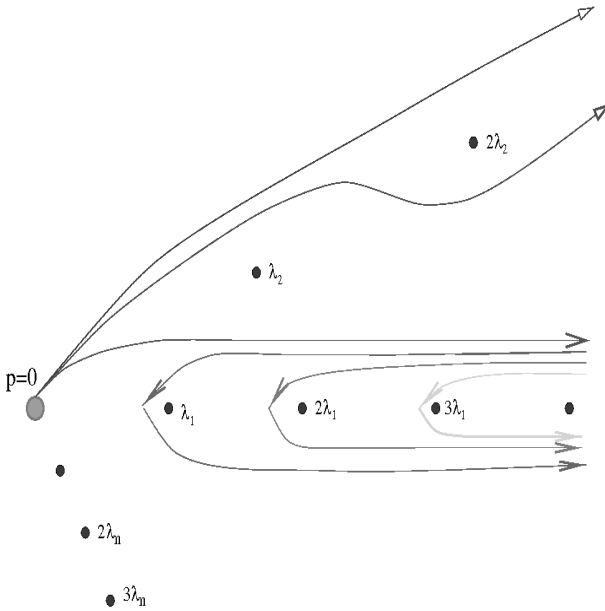

FIGURE 5.1: The paths near λ_1 relate to the medianized averages.

By symmetry (renumbering the directions) it suffices to analyze the singu-

⁷Classes of curves that can be continuously deformed into each other without crossing points outside \mathcal{W} .

larity structure of \mathbf{Y}_0 in \mathcal{R}_1 only. However, for $\mathbf{k} \neq 0$ the properties of $\mathbf{Y}_{\mathbf{k}}$ will be analyzed along some other regions as well.

5.8b Ordering on \mathbb{N}^n

The notation is essentially the one already used for multiserries and transseries:

We write $\mathbf{k} \succeq \mathbf{k}'$ if $k_i \geq k'_i$ for all i and $\mathbf{k} \succ \mathbf{k}'$ if $\mathbf{k} \succeq \mathbf{k}'$ and $\mathbf{k} \neq \mathbf{k}'$. The relation \succ is a well-ordering on \mathbb{N}^n . We let \mathbf{e}_j be the unit vector in the j^{th} direction in \mathbb{N}^n .

5.8c Analytic continuations between singularities

By $AC_\gamma(f)$ we denote the analytic continuation of f along a curve γ .

For the analytic continuations near a singular line $d_{i,\mathbf{k}}$ the notation is similar to Écalle’s:

f^- is the branch of f along a path γ with $\arg(\gamma) = \phi_i - 0$, while f^{-j+} denotes the branch along a path that crosses the singular line between $j\lambda_i$ and $(j + 1)\lambda_i$, from right to left; see also [25].

We write $\mathcal{P}f$ for $\int_0^p f(s)ds$ and $\mathcal{P}_\gamma f$ if integration is along the curve γ .

5.9 Analytic properties of $\mathbf{Y}_{\mathbf{k}}$ and resurgence

We let $m_i = 2 + \lfloor \text{Re } \alpha_i \rfloor$ and $\alpha'_i = m_i - \alpha_i$ and denote $\mathbf{Y}_{\mathbf{k}} = \mathcal{B}\tilde{\mathbf{y}}_{\mathbf{k}}$ and $\mathbf{Y}_{\mathbf{k}}^\pm$ the upper (lower, respectively) analytic branches of $\mathbf{Y}_{\mathbf{k}}^\pm$.

Theorem 5.67 *(i) $\mathbf{Y}_0 = \mathcal{B}\tilde{\mathbf{y}}_0$ is analytic in $\mathcal{R} \cup \{0\}$.*

The singularities of \mathbf{Y}_0 (which are contained in the set $\{l\lambda_j : l \in \mathbb{N}^+, j = 1, 2, \dots, n\}$) are described as follows. For $l \in \mathbb{N}^+$ and small z , using the notations explained in §5.8a we have

$$\begin{aligned} \mathbf{Y}_0^\pm(z + l\lambda_j) &= \pm \left[(\pm S_j)^l (\ln z)^{0,1} \mathbf{Y}_{l\mathbf{e}_j}(z) \right]^{(lm_j)} + \mathbf{B}_{l_j}(z) = \\ &\quad \left[z^{l\alpha'_j - 1} (\ln z)^{0,1} \mathbf{A}_{l_j}(z) \right]^{(lm_j)} + \mathbf{B}_{l_j}(z) \quad (l = 1, 2, \dots) \end{aligned} \tag{5.68}$$

where the power of $\ln z$ is one iff $l\alpha_j \in \mathbb{Z}$, and $\mathbf{A}_{l_j}, \mathbf{B}_{l_j}$ are analytic for small z . The functions $\mathbf{Y}_{\mathbf{k}}$ are, exceptionally, analytic at $p = l\lambda_j$, $l \in \mathbb{N}^+$, iff the Stokes constants vanish, i.e.,

$$S_j = r_j \Gamma(\alpha'_j) (\mathbf{A}_{1,j})_j(0) = 0 \tag{5.69}$$

where $r_j = 1 - e^{2\pi i(\alpha'_j - 1)}$ if $l\alpha_j \notin \mathbb{Z}$ and $r_j = -2\pi i$ otherwise.

Analyticity and resurgence of $\mathbf{Y}_k, k \succ 0$.

(ii) $\mathbf{Y}_k = \mathcal{B}\tilde{\mathbf{Y}}_k, |k| > 1$, are analytic in $\mathcal{R} \setminus S_k$, where

$$S_k = \{-k' \cdot \lambda + \lambda_i : k' \leq k, 1 \leq i \leq n\} \tag{5.70}$$

(That is, the singularities of \mathbf{Y}_k are those of \mathbf{Y}_0 , together with a finite number of new ones, given in (5.70).)

For $l \in \mathbb{N}^+$ and p near $l\lambda_j, j = 1, 2, \dots, n$ there exist $\mathbf{A} = \mathbf{A}_{kjl}$ and $\mathbf{B} = \mathbf{B}_{kjl}$ analytic at zero so that for small z we have

$$\begin{aligned} \mathbf{Y}_k^\pm(z + l\lambda_j) &= \pm \left[(\pm S_j)^l \binom{k_j + l}{l} (\ln z)^{0,1} \mathbf{Y}_{k+l\mathbf{e}_j}(z) \right]^{(lm_j)} + \mathbf{B}_{klj}(z) = \\ & \left[z^{k \cdot \alpha' + l\alpha'_j - 1} (\ln z)^{0,1} \mathbf{A}_{klj}(z) \right]^{(lm_j)} + \mathbf{B}_{klj}(z) \quad (l = 0, 1, 2, \dots) \end{aligned} \tag{5.71}$$

where the power of $\ln z$ is 0 iff $l = 0$ or $k \cdot \alpha + l\alpha_j \notin \mathbb{Z}$ and $\mathbf{A}_{k0j} = \mathbf{e}_j / \Gamma(\alpha'_j)$. Near $p \in \{\lambda_i - k' \cdot \lambda : 0 < k' \leq k\}$, (where \mathbf{Y}_0 is analytic) \mathbf{Y}_k have convergent Puiseux series for $k \neq 0$.

5.9.1 Properties of the analytic continuation along singular rays

In the following formulas we make the convention $\mathbf{Y}_k(p - j) = 0$ for $p < j$. The following result shows how continuations along different paths are related to each other.

Theorem 5.72 For all k and $\text{Re}(p) > j, \text{Im}(p) > 0$ as well as in distributions (more precisely the space of distributions $\mathcal{D}'_{m,\nu}$; see §5.12 and [23]) we have

$$\mathbf{Y}_k^{\pm j \mp}(p) - \mathbf{Y}_k^{\pm(j-1) \mp}(p) = (\pm S_1)^j \binom{k_1 + j}{j} \left(\mathbf{Y}_{k+j\mathbf{e}_1}^\mp(p - j) \right)^{(mj)} \tag{5.73}$$

and also,

$$\mathbf{Y}_k^\pm = \mathbf{Y}_k^\mp + \sum_{j \geq 1} \binom{j + k_1}{k_1} (\pm S_1)^j \left(\mathbf{Y}_{k+j\mathbf{e}_1}^\mp(p - j) \right)^{(mj)} \tag{5.74}$$

Remark 5.75 (Resurgence) The fact that the singular part of $\mathbf{Y}_k(p + l\lambda_j)$ in (5.68) and (5.71) is a multiple of $\mathbf{Y}_{k+l\mathbf{e}_j}(p)$ is a consequence of resurgence and provides a way of determining the \mathbf{Y}_k given \mathbf{Y}_0 provided the S_j are nonzero. Since, generically, the S_j are nonzero, given one formal solution, (generically) an n parameter family of solutions can be constructed out of it, without using (5.51) in the process; the differential equation itself is then recoverable.

*

Averaging. Let $\gamma \in \mathbb{C}$. We extend $\mathcal{B}\tilde{\mathbf{y}}_{\mathbf{k}}$ along $d_{j,\mathbf{k}}$ by the weighted average of analytic continuations

$$\mathbf{Y}_{\mathbf{k}}^\gamma := \mathbf{Y}_{\mathbf{k}}^+ + \sum_{j=1}^\infty \gamma^j \left(\mathbf{Y}_{\mathbf{k}}^- - \mathbf{Y}_{\mathbf{k}}^{-(j-1)+} \right) \tag{5.76}$$

Proposition 5.77 *Relation (5.76) with $\text{Re } \gamma = 1/2$ gives the most general reality preserving, linear operator mapping formal power series solutions of (5.51) to solutions of (5.89) in $\mathcal{D}'_{m,\nu}$.*

This follows from Proposition 23 in [23] and Theorem 5.72.

For the choice $\gamma = 1/2$ the expression (5.76) coincides with the one in which + and - are interchanged (Proposition 34 in [23]), and this yields a reality-preserving summation. In this case we call $\mathbf{Y}_{\mathbf{k}}^{ba} =: \mathbf{Y}_{\mathbf{k}}^{1/2}$ the balanced average of $\mathbf{Y}_{\mathbf{k}}^\pm$, and it is the restriction of the median average to generic systems of ODEs, becoming much simpler because of the extra structure inherited from the differential equation. It is *not* multiplicative in general, that is outside the ODE context, while the median average *is*.

Remark 5.78 Clearly, if $\mathbf{Y}_{\mathbf{k}}$ is analytic along $d_{j,\mathbf{k}}$, then the terms in the infinite sum vanish and $\mathbf{Y}_{\mathbf{k}}^\gamma = \mathbf{Y}_{\mathbf{k}}$. For any $\mathbf{Y}_{\mathbf{k}}$ this is the case for all directions apart from the finitely many singular ones.

It follows from (5.76) and Theorem 5.79 that the Laplace integral of $\mathbf{Y}_{\mathbf{k}}^\gamma$ along \mathbb{R}^+ can be deformed into contours as those depicted in Fig. 5.1, with weight $(-\gamma)^k$ for a contour turning around $k\lambda_1$.

In addition to symmetry (the balanced average equals the half-sum of the upper and lower continuations on $(0, 2\lambda_1)$), an asymptotic property uniquely picks $C = 1/2$. Namely, for $C = 1/2$ alone are the $\mathcal{L}\mathcal{B}\tilde{\mathbf{y}}_{\mathbf{k}}$ always *summable to the least term*; see [23] and [19].

5.9a Summability of the transseries

The following is an abbreviated form of a theorem in [23]. The statements are more precise there and more details are given about the functions, but to present them here would require introducing many new notations.

For clarity we again specialize to a sector in \mathbb{H} in x containing $\lambda_1 = 1$ in which (c1) of §5.6b holds (and for p in the associated domain \mathcal{R}'_1), but λ_1 plays no special role as discussed in the introduction.

Theorem 5.79 – *The limits (in distributions, in $\mathcal{D}'_{m,\nu}$ —see §5.12 and [23]) of $\mathbf{Y}_{\mathbf{k}}^{+n-}(p)$ and $\mathbf{Y}_{\mathbf{k}}^{-n+}(p)$ on \mathbb{R}^+ exist for all k and n .*

—There is an x_0 large enough so that for $\text{Re}(xp/|p|) > x_0$ all the Laplace transforms in distributions, $\int_S e^{-xp} \mathbf{Y}_k^{+n-}(p) dp$ exist and are bounded by μ^k for some $\mu > 0$.

—The series

$$\mathbf{y} = \mathcal{L}\mathbf{Y}_0^+ + \sum_{|\mathbf{k}|>0} \mathbf{C}_+^{\mathbf{k}} e^{-\mathbf{k}\cdot\lambda x} x^{\mathbf{k}\cdot\alpha} \mathcal{L}\mathbf{Y}_k^+ \tag{5.80}$$

$$\mathbf{y} = \mathcal{L}\mathbf{Y}_0^- + \sum_{|\mathbf{k}|>0} \mathbf{C}_-^{\mathbf{k}} e^{-\mathbf{k}\cdot\lambda x} x^{\mathbf{k}\cdot\alpha} \mathcal{L}\mathbf{Y}_k^- \tag{5.81}$$

are convergent for large enough $\text{Re} x$, and either one of them provides the most general decaying solution of (5.51) along S (so there is a multiplicity of representation).

—The Laplace transformed average

$$\mathcal{L}\left[\mathbf{Y}_k^+ + \sum_{j=1}^{\infty} \gamma^j \left(\mathbf{Y}_k^- - \mathbf{Y}_k^{-(j-1)+}\right)\right] \tag{5.82}$$

commutes with complex conjugation and multiplication.

Of special interest are the cases $\gamma = 1/2$, discussed below, and also $\gamma = 0, 1$ which give:

$$\mathbf{y} = \mathcal{L}\mathbf{Y}_0^{\pm} + \sum_{|\mathbf{k}|>0} \mathbf{C}^{\mathbf{k}} e^{-\mathbf{k}\cdot\lambda x} x^{\mathbf{k}\cdot\alpha} \mathcal{L}\mathbf{Y}_k^{\pm} \tag{5.83}$$

*

The series $\tilde{\mathbf{y}}_0$ is a formal solution of (5.51) while, for $\mathbf{k} \neq 0$, the functions $\tilde{\mathbf{y}}_k$ satisfy a hierarchy of linear differential equations [58] (see also §5.11b for further details). In

$$\mathbf{y} = \mathcal{L}\mathcal{B}\tilde{\mathbf{y}}_0 + \sum_{\mathbf{k}\geq 0; |\mathbf{k}|>0} C_1^{k_1} \dots C_n^{k_n} e^{-(\mathbf{k}\cdot\lambda)x} x^{\mathbf{k}\cdot\alpha} \mathcal{L}\mathcal{B}\tilde{\mathbf{y}}_k \quad (x \rightarrow \infty, \arg(x) \text{ fixed}) \tag{5.84}$$

given \mathbf{y} , the value of C_i can only change (and it usually does) when $\arg(x) + \arg(\lambda_i - \mathbf{k}\cdot\lambda) = 0$, $k_i \in \mathbb{N}$, i.e., when crossing one of the (finitely many by (c1)) Stokes rays.

5.10 Outline of the proofs

5.10a Summability of the transseries in nonsingular directions: A sketch

We have

$$\mathbf{g}(x, \mathbf{y}) = \sum_{|\mathbf{l}| \geq 1} \mathbf{g}_{\mathbf{l}}(x) \mathbf{y}^{\mathbf{l}} = \sum_{s \geq 0; |\mathbf{l}| \geq 1} \mathbf{g}_{s, \mathbf{l}} x^{-s} \mathbf{y}^{\mathbf{l}} \quad (|x| > x_0, |\mathbf{y}| < y_0) \quad (5.85)$$

where we denote

$$\mathbf{y}^{\mathbf{l}} = y_1^{l_1} \cdots y_n^{l_n}, \quad |\mathbf{l}| = l_1 + \cdots + l_n; \quad \text{also } |\mathbf{y}| := \max\{|y_i| : i = 1, \dots, n\} \quad (5.86)$$

By construction $\mathbf{g}_{s, \mathbf{l}} = 0$ if $|\mathbf{l}| = 1$ and $s \leq M$.

The formal inverse Laplace transform of $\mathbf{g}(x, \mathbf{y}(x))$ (formal since we have not yet shown that $\mathcal{L}^{-1}\mathbf{y}$ exists) is given by:

$$\begin{aligned} \mathcal{L}^{-1} \left(\sum_{|\mathbf{l}| \geq 1} \mathbf{y}(x)^{\mathbf{l}} \sum_{s \geq 0} \mathbf{g}_{s, \mathbf{l}} x^{-s} \right) &= \sum_{|\mathbf{l}| \geq 1} \mathbf{G}_{\mathbf{l}} * \mathbf{Y}^{*\mathbf{l}} + \sum_{|\mathbf{l}| \geq 2} \mathbf{g}_{0, \mathbf{l}} \mathbf{Y}^{*\mathbf{l}} \quad (5.87) \\ &= \mathcal{N}(\mathbf{Y}) = (\mathcal{L}^{-1}\mathbf{g})(\mathbf{p}, * \mathbf{Y}) = \mathbf{G}(\mathbf{p}, * \mathbf{Y}) \end{aligned} \quad (5.88)$$

where the last two equalities are mere suggestive notations. For instance, $\mathcal{L}^{-1}\mathbf{g}(\mathbf{1}/\mathbf{x}, \mathbf{y})$, after series expansion in convolution powers of \mathbf{Y} is essentially the Taylor series in \mathbf{y} of \mathbf{g} , with multiplication replaced by convolution.

(Direct calculations, using expanded formulas for $\mathbf{G}(\mathbf{p}, * \mathbf{Y})$, etc., are given in §5.10c.)

Also, $\mathbf{G}_{\mathbf{l}}(\mathbf{p}) = \sum_{s=1}^{\infty} \mathbf{g}_{s, \mathbf{l}} \mathbf{p}^{s-1} / s!$ and $(\mathbf{G}_{\mathbf{l}} * \mathbf{Y}^{*\mathbf{l}})_j := (\mathbf{G}_{\mathbf{l}})_j * Y_1^{*l_1} * \dots * Y_n^{*l_n}$.

By (n5), $\mathbf{G}_{\mathbf{l}, 1}^{(l)}(0) = 0$ if $|\mathbf{l}| = 1$ and $l \leq M$.

Thus the inverse Laplace transform of (5.51) is the convolution equation:

$$-p\mathbf{Y} = \mathbf{F}_0 - \hat{\Lambda}\mathbf{Y} + \hat{A}\mathcal{P}\mathbf{Y} + \mathbf{G}(\mathbf{p}, * \mathbf{Y}) \quad (5.89)$$

Let $\mathbf{d}_{\mathbf{j}}(x) := \sum_{|\mathbf{j}| \geq \mathbf{j}} \binom{\mathbf{l}}{\mathbf{j}} \mathbf{g}_{\mathbf{l}}(x) \tilde{\mathbf{y}}_0^{\mathbf{l}-\mathbf{j}}$. Straightforward calculation (see [Appendix §5.11b](#); cf. also [25]) shows that the components $\tilde{\mathbf{y}}_{\mathbf{k}}$ of the transseries satisfy the hierarchy of differential equations

$$\mathbf{y}'_{\mathbf{k}} + \left(\hat{\Lambda} - \frac{1}{x} \left(\hat{A} + \mathbf{k} \cdot \boldsymbol{\alpha} \right) - \mathbf{k} \cdot \boldsymbol{\lambda} \right) \mathbf{y}_{\mathbf{k}} + \sum_{|\mathbf{j}|=1} \mathbf{d}_{\mathbf{j}}(x) (\mathbf{y}_{\mathbf{k}})^{\mathbf{j}} = \mathbf{t}_{\mathbf{k}} \quad (5.90)$$

where $\mathbf{t}_k = \mathbf{t}_k(\mathbf{y}_0, \{\mathbf{y}_{k'}\}_{0 \prec k' \prec k})$ is a *polynomial* in $\{\mathbf{y}_{k'}\}_{0 \prec k' \prec k}$ and in $\{\mathbf{d}_j\}_{j \leq k}$ (see (5.282)), with $\mathbf{t}(y_0, \emptyset) = 0$; \mathbf{t}_k satisfies the homogeneity relation

$$\mathbf{t}_k \left(\mathbf{y}_0, \left\{ C^{k'} \mathbf{y}_{k'} \right\}_{0 \prec k' \prec k} \right) = C^k \mathbf{t}_k \left(\mathbf{y}_0, \{\mathbf{y}_{k'}\}_{0 \prec k' \prec k} \right) \tag{5.91}$$

Taking \mathcal{L}^{-1} in (5.90) we get, with $\mathbf{D}_j = \sum_{l \geq j} \binom{l}{j} \left[\mathbf{G}_1 * \mathbf{Y}_0^{*(1-j)} + \mathbf{g}_{0,1} * \mathbf{Y}_0^{*(1-j)} \right]$,

$$\left(-p + \hat{\Lambda} - \mathbf{k} \cdot \boldsymbol{\lambda} \right) \mathbf{Y}_k - \left(\hat{A} + \mathbf{k} \cdot \boldsymbol{\alpha} \right) \mathcal{P} \mathbf{Y}_k + \sum_{|\mathbf{j}|=1} \mathbf{D}_j * \mathbf{Y}_k^j = \mathbf{T}_k \tag{5.92}$$

where of course, for $|\mathbf{j}| = 1$, we have $\mathbf{Y}_k^{*\mathbf{j}} = \mathbf{Y}_k^{\mathbf{j}}$; now \mathbf{T}_k is a *convolution polynomial*, cf. (5.206).

*

Since \mathbf{g} is assumed analytic for small $|\mathbf{y}| < \epsilon$ we have

$$\mathbf{g}(1/x, \mathbf{y}) = \sum_{\mathbf{l}} \mathbf{g}_l \mathbf{y}^{\mathbf{l}} \tag{5.93}$$

and by Cauchy's formula and Fubini we have

$$\mathbf{g}_l = \text{const.} \oint \cdots \oint \frac{\mathbf{g}(1/x, \mathbf{s})}{s_1^{l_1+1} \cdots s_n^{l_n+1}} d\mathbf{s} \tag{5.94}$$

and therefore by (n5) p. 156 we have

$$|\mathbf{g}_l| \leq A_1^{|\mathbf{l}|} |x|^{-M-1} \tag{5.95}$$

for some A_1 and thus

$$|\mathbf{G}_1| \leq A^{|\mathbf{l}|} |p|^M; \quad |\mathbf{g}_{0,1}| \leq A^{|\mathbf{l}|} \tag{5.96}$$

for some $A > 0$, where $\mathbf{G}_1 = \mathcal{L}^{-1} \mathbf{g}_1$. Similarly,

$$\mathbf{g}(1/x, \mathbf{y} + \mathbf{h}) - \mathbf{g}(1/x, \mathbf{y}) = \sum_{\mathbf{j} > 0} \mathbf{g}_1(1/x; \mathbf{y}) \mathbf{h}^{\mathbf{j}} \tag{5.97}$$

or

$$\mathcal{L}^{-1} \mathbf{g}(1/x, \mathbf{y} + \mathbf{h}) - \mathcal{L}^{-1} \mathbf{g}(1/x, \mathbf{y}) = \mathcal{L}^{-1} \left(\sum_{\mathbf{j} > 0} \mathbf{g}_1(1/x; \mathbf{y}) \mathbf{h}^{\mathbf{j}} \right) = \sum_{\mathbf{j} > 0} \check{\mathbf{G}}_1 * \mathbf{H}^{*\mathbf{j}} \tag{5.98}$$

where

$$|\check{\mathbf{G}}_1| \leq B^{|\mathbf{l}|} |p|^M \tag{5.99}$$

It follows that in any of the focusing norms used we have

$$\|\mathbf{G}(p, * \mathbf{Y})\|_\nu \rightarrow 0 \quad \nu \rightarrow \infty \tag{5.100}$$

Similarly, we have

$$\mathbf{G}(p, *(\mathbf{Y} + \mathbf{H})) - \mathbf{G}(p, * \mathbf{Y}) = \mathbf{D}_1(p, * \mathbf{Y}) * \mathbf{H} + o(\|\mathbf{H}\|_\nu) \tag{5.101}$$

where

$$\mathbf{D}_1(p, * \mathbf{Y}) = \left(\mathcal{L}^{-1} \frac{\partial \mathbf{g}}{\partial \mathbf{y}} \right) (p, * \mathbf{Y}); \quad \|\mathbf{D}_1(p, * \mathbf{Y})\| \rightarrow 0 \text{ as } \nu \rightarrow \infty \tag{5.102}$$

We write Eq. (5.89) in the form

$$(-p + \hat{\Lambda}) \mathbf{Y} = \mathbf{F}_0 + \hat{A}(1 * \mathbf{Y}) + \mathbf{G}(p, * \mathbf{Y}) \tag{5.103}$$

Consider a region in \mathbb{C} of the form

$$\mathcal{S} = \{p \in \mathbb{C} : |p| \leq \epsilon \text{ or } \arg(p) \in (a, b)\} \tag{5.104}$$

not containing singular directions. Then the matrix $(-p + \hat{\Lambda})$ is invertible and

$$\mathbf{Y} = (-p + \hat{\Lambda})^{-1} \left[\mathbf{F}_0 + \hat{A}(1 * \mathbf{Y}) + \mathbf{G}(p, * \mathbf{Y}) \right] \tag{5.105}$$

Let $\mathcal{A}(\mathcal{S})$ be any of the focusing algebras over \mathcal{S} .

Proposition 5.106 *Eq. (5.105) is contractive in \mathcal{S} and has a unique solution there.*

PROOF This follows immediately from (5.101) and (5.102). □

5.10b Higher terms of the transseries

The equations with $|\mathbf{k}| = 1$ are special: they are singular at $p = 0$. Indeed, with $\mathbf{k} = \mathbf{e}_m =: \mathbf{e}$ (the m -th unit vector; see p. 160) we have

$$\left(-p + \hat{\Lambda} - \mathbf{e} \cdot \boldsymbol{\lambda}\right) \mathbf{Y}_{\mathbf{e}} - \left(\hat{A} + \mathbf{e} \cdot \boldsymbol{\alpha}\right) \mathcal{P} \mathbf{Y}_{\mathbf{e}} + \sum_{|\mathbf{j}|=1} \mathbf{D}_{\mathbf{j}} * \mathbf{Y}_{\mathbf{e}}^{\mathbf{j}} = 0 \tag{5.107}$$

where $\hat{\Lambda} - \mathbf{e} \cdot \boldsymbol{\lambda}$ is not invertible.

Suppose first $\mathbf{D}_{\mathbf{j}} = 0$. Then (5.107) is just a system of linear ODEs, written in integral form, at a *regular* singularity. The fact that the singularity is regular follows from the assumptions (a1)—(n5). The general theory of ODE applies and $\mathbf{Y}_{\mathbf{e}}$ has a convergent Frobenius expansion at zero.

In general, for small p , $\mathbf{D}_{\mathbf{j}} = O(p^2)$, because of the behavior of \mathbf{Y}_0 . Then near the origin, the contribution of these terms is small. One writes

$$\left(-p + \hat{\Lambda} - \mathbf{e} \cdot \boldsymbol{\lambda}\right) \mathbf{Y}_{\mathbf{e}} - \left(\hat{A} + \mathbf{e} \cdot \boldsymbol{\alpha}\right) \mathcal{P} \mathbf{Y}_{\mathbf{e}} = \mathbf{R} \tag{5.108}$$

where

$$\mathbf{R} = - \sum_{|\mathbf{j}|=1} \mathbf{D}_{\mathbf{j}} * \mathbf{Y}_{\mathbf{e}}^{*\mathbf{j}} \tag{5.109}$$

and inverts the operator on the left side of (5.108). In the process of inversion one free constant, C_m , is generated (a free constant was to be expected, since (5.107) is homogeneous). For any value of C_m , however, the ensuing integral equation is contractive.

For $|\mathbf{k}| > 1$, $(-p + \hat{\Lambda} - \mathbf{k} \cdot \boldsymbol{\lambda})$ is invertible in \mathcal{S} , again by (a1)–(n5). The homogeneous part of the (linear equations) for $\mathbf{Y}_{\mathbf{k}}$ is regular. But the inhomogeneous term is singular at $p = 0$, due to $\mathbf{Y}_{\mathbf{e}}$.

The equations are treated in a space designed to accommodate these singularities. Contractivity of the system of equations for the $\mathbf{Y}_{\mathbf{k}}$; $|\mathbf{k}| > 1$, as well as summability of the resulting transseries and the fact that it solves (5.51) are then shown essentially as in §5.3b.

The analysis of the convolution equations along singular directions is more delicate, but not so different in spirit from the analysis of the equation for $\mathbf{Y}_{\mathbf{e}}$ at $p = 0$: near singular points, the convolution equations are well approximated by regularly singular ODEs.

However, new problems arise if $\text{Re } \alpha > 0$. Then the singularities of the functions $\mathbf{Y}_{\mathbf{k}}$, always located in $S_{\mathbf{k}}$, are nonintegrable, of strengths growing with the distance to the origin, as seen in (5.71). In [23] this is dealt with by working in $\mathcal{D}'_{m,\nu}$.

***5.10c Detailed proofs, for $\text{Re } (\alpha_1) < 0$ and a 1 parameter transseries**

This section essentially follows [25]. The simplifying assumptions are removed in [23].

We use the notation (5.61) and $\beta = \beta_1$. We have $\text{Re } \beta > 0$. The substitution described above (n4) makes

$$\text{Re } (\beta) \in (0, 1] \tag{5.110}$$

The *one*-parameter family of transseries formally small in a half-plane is given by

$$\tilde{\mathbf{y}} = \tilde{\mathbf{y}}_0 + \sum_{k=1}^{\infty} C^k e^{-kx} \tilde{\mathbf{y}}_k \tag{5.111}$$

where the series $\tilde{\mathbf{y}}_k$ are small; (5.90) becomes

$$\mathbf{y}'_k + \left(\hat{\Lambda} + \frac{1}{x} \hat{B} - k - \partial \mathbf{g}(x, \mathbf{y}_0) \right) \mathbf{y}_k = \sum_{|\mathbf{l}|>1} \mathbf{g}^{(\mathbf{l})}(x, \mathbf{y}_0) \mathbf{l}!^{-1} \sum_{\Sigma m=k} \prod_{i=1}^n \prod_{j=1}^{l_i} (\mathbf{y}_{m_{i,j}})_{i} \tag{5.112}$$

where $\mathbf{g}^{(l)} := \partial^{(l)}\mathbf{g}/\partial\mathbf{y}^l$, $(\partial\mathbf{g})\mathbf{y}_k := \sum_{i=1}^n (\mathbf{y}_k)_i (\partial\mathbf{g}/\partial y_i)$, and $\sum_{\Sigma m=k}$ stands for the sum over all integers $m_{i,j} \geq 1$ with $1 \leq i \leq n, 1 \leq j \leq l_i$ such that $\sum_{i=1}^n \sum_{j=1}^{l_i} m_{i,j} = k$.

Since $m_{i,j} \geq 1$, we have $\sum m_{i,j} = k$ (fixed) and $\text{card}\{m_{i,j}\} = |\mathbf{l}|$, the sums in (5.112) contain only a *finite* number of terms. We use the convention $\prod_{i \in \emptyset} \equiv 0$.

In the following, we choose the usual branch of the logarithm, positive for $x > 1$.

Proposition 5.113 (i) *The function $\mathbf{Y}_0 := \mathcal{B}\tilde{\mathbf{y}}_0$ is analytic in \mathcal{W} and Laplace transformable along any direction in \mathcal{W} . In a neighborhood of $p = 1$ we have*

$$\mathbf{Y}_0(p) = \begin{cases} S_\beta(1-p)^{\beta-1}\mathbf{A}(p) + \mathbf{B}(p) & \text{for } \beta \neq 1 \\ S_\beta \ln(1-p)\mathbf{A}(p) + \mathbf{B}(p) & \text{for } \beta = 1 \end{cases} \quad (5.114)$$

(see (5.110)), where \mathbf{A}, \mathbf{B} are (\mathbb{C}^n -valued) analytic functions in a neighborhood of $p = 1$.

(ii) *The functions $\mathbf{Y}_k := \mathcal{B}\tilde{\mathbf{y}}_k$, $k = 0, 1, 2, \dots$ are analytic in \mathcal{R}_1 .*

(iii) *For small p we have*

$$\mathbf{Y}_0(p) = p\mathbf{A}_0(p); \quad \mathbf{Y}_k(p) = p^{k\beta-1}\mathbf{A}_k(p), \quad k \in \mathbb{N}^+ \quad (5.115)$$

where $\mathbf{A}_k, k \geq 0$, are analytic functions in a neighborhood of $p = 0$ in \mathbb{C} .

(iv) *If $S_\beta = 0$, then $\mathbf{Y}_k, k \geq 0$, are analytic in $\mathcal{W} \cup \mathbb{N}$.*

(v) *The analytic continuations of \mathbf{Y}_k along paths in \mathcal{R}_1 are in $L^1_{\text{loc}}(\mathbb{R}^+)$ (their singularities along \mathbb{R}^+ are integrable⁸). The analytic continuations of the \mathbf{Y}_k in \mathcal{R}_1 can be expressed in terms of each other through resurgence relations:*

$$S_\beta^k \mathbf{Y}_k = \left(\mathbf{Y}_0^- - \mathbf{Y}_0^{-k-1+} \right) \circ \tau_k, \quad \text{on } (0, 1); \quad (\tau_a := p \mapsto p + a) \quad (5.116)$$

relating the higher index series in the transseries to the first series and

$$\mathbf{Y}_k^{-m+} = \mathbf{Y}_k^+ + \sum_{j=1}^m \binom{k+j}{k} S_\beta^j \mathbf{Y}_{k+j}^+ \circ \tau_j \quad (5.117)$$

S_β is related to the Stokes constant [58] S by

⁸For integrability, the condition $\text{Re } \beta > 0$ is essential.

$$S_\beta = \begin{cases} \frac{iS}{2 \sin(\pi(1 - \beta))} & \text{for } \beta \neq 1 \\ \frac{iS}{2\pi} & \text{for } \beta = 1 \end{cases}$$

Let \mathbf{Y} be one of the functions \mathbf{Y}_k and define, on $\mathbb{R}^+ \cap \mathcal{R}_1$ the “balanced average⁹” of \mathbf{Y} :

$$\mathbf{Y}^{ba} = \mathbf{Y}^+ + \sum_{k=1}^\infty 2^{-k} \mathcal{H} \circ \tau_{-k} \left(\mathbf{Y}^- - \mathbf{Y}^{-k-1+} \right) \tag{5.118}$$

(\mathcal{H} is Heaviside’s function, the characteristic function of \mathbb{R}^+). For any value of p , only finitely many terms (5.118) are nonzero. Moreover, the balanced average preserves reality in the sense that if (5.51) is real and $\tilde{\mathbf{y}}_0$ is real, then \mathbf{Y}^{ba} is real on $\mathbb{R}^+ - \mathbb{N}$ (and in this case the formula can be symmetrized by taking 1/2 of the expression above plus 1/2 of the same expression with + and - interchanged). Equation (5.118) has the main features of medianization (cf. [34]), in particular (unlike individual analytic continuations; see Appendix 5.11a) commutes with convolution (cf. Theorem 5.129). \mathbf{Y}^{ba} is exponentially bounded at infinity for the functions we are dealing with.

Let again $\tilde{\mathbf{y}}$ be one of $\tilde{\mathbf{y}}_k$ and $\mathbf{Y} = \mathcal{B}\tilde{\mathbf{y}}$. We define:

$$\begin{aligned} \mathcal{L}_\phi \mathcal{B}\tilde{\mathbf{y}} &:= \mathcal{L}_\phi \mathbf{Y} = x \mapsto \int_0^{\infty e^{i\phi}} \mathbf{Y}(p) e^{-px} dp \quad \text{if } \phi \neq 0 \\ \mathcal{L}_0 \mathcal{B}\tilde{\mathbf{y}} &:= \mathcal{L}_0 \mathbf{Y} = x \mapsto \int_0^\infty \mathbf{Y}^{ba}(p) e^{-px} dp \quad \text{if } \phi = 0 \end{aligned} \tag{5.119}$$

(the first relation is the usual one, the second one defines summation along the Stokes ray).

The connection between true and formal solutions of the differential equation is given in the following theorem:

Theorem 5.120 (i) *There is a large enough ν such that, for $\text{Re}(x) > \nu$ the Laplace transforms $\mathcal{L}_\phi \mathbf{Y}_k$ exist for all $k \geq 0$ in*

$$\mathcal{W}_1 := \{p : p \notin \mathbb{N} \text{ and } \arg p \in (-\phi_-, \phi_+)\} \tag{5.121}$$

where we denote, for simplicity, by ϕ^+ the singular direction nearest to \mathbb{R}^+ in \mathbb{H} (similarly for ϕ_-). For $\phi \in (-\phi_-, \phi_+)$ and any C , the series

$$\mathbf{y}(x) = (\mathcal{L}_\phi \mathcal{B}\tilde{\mathbf{y}}_0)(x) + \sum_{k=1}^\infty C^k e^{-kx} (\mathcal{L}_\phi \mathcal{B}\tilde{\mathbf{y}}_k)(x) \tag{5.122}$$

⁹As mentioned, it coincides with Écalle’s medianization, but is simpler here due to the special features of ODEs.

is convergent for large enough x in \mathbb{H} .

The function \mathbf{y} in (5.122) is a solution of the differential equation (5.51).

Furthermore, for any $k \geq 0$ we have $\mathcal{L}_\phi \mathbf{B}\tilde{\mathbf{y}}_k \sim \tilde{\mathbf{y}}_k$ in \mathbb{H} and $\mathcal{L}_\phi \mathbf{B}\tilde{\mathbf{y}}_k$ is a solution of the corresponding equation in (5.90).

(ii) Conversely, given ϕ , any solution of (5.51) having $\tilde{\mathbf{y}}_0$ as an asymptotic series \mathbb{H} can be written in the form (5.122), for a unique C .

(iii) The constant C , associated in (ii) with a given solution \mathbf{y} of (5.51), depends on the angle ϕ :

$$C(\phi) = \begin{cases} C(0_+) & \text{for } \phi > 0 \\ C(0_+) - \frac{1}{2}S_\beta & \text{for } \phi = 0 \\ C(0_+) - S_\beta & \text{for } \phi < 0 \end{cases} \tag{5.123}$$

See also (5.114).

When ϕ is not a singular direction, the description of the solutions is quite simple:

Proposition 5.124 (i) With ϕ describing a ray in \mathcal{W} , the equation (5.89) has a unique solution in $L^1_{\text{loc}}(\Phi)$, namely $\mathbf{Y}_0 = \mathbf{B}\tilde{\mathbf{y}}_0$.

(ii) For any ray in \mathcal{W}_1 , the system (5.89), (5.92) has the general solution $C^k \mathbf{Y}_k = C^k \mathbf{B}\tilde{\mathbf{y}}_k$, $k \geq 0$.

The more interesting case $\phi = 0$ is addressed in the following theorem:

Theorem 5.125 (i) The general solution in $L^1_{\text{loc}}(\mathbb{R}^+)$ of (5.89) is

$$\mathbf{Y}_C(p) = \sum_{k=0}^{\infty} C^k \mathbf{Y}_k^{ba}(p-k) \mathcal{H}(p-k) \tag{5.126}$$

with $C \in \mathbb{C}$ arbitrary.

(ii) Near $p = 1$, \mathbf{Y}_C is given by:

$$\mathbf{Y}_C(p) = \begin{cases} S_\beta(1-p)^{\beta-1} \mathbf{A}(p) + \mathbf{B}(p) & \text{for } p < 1 \\ C(1-p)^{\beta-1} \mathbf{A}(p) + \mathbf{B}(p) & \text{for } p > 1 \end{cases} \quad (\beta \neq 1) \tag{5.127}$$

$$\mathbf{Y}_C(p) = \begin{cases} S_\beta \ln(1-p) \mathbf{A}(p) + \mathbf{B}(p) & \text{for } p < 1 \\ (S_\beta \ln(1-p) + C) \mathbf{A}(p) + \mathbf{B}(p) & \text{for } p > 1 \end{cases} \quad (\beta = 1)$$

where \mathbf{A} and \mathbf{B} are analytic in a neighborhood of $p = 1$.

(iii) With the choice $\mathbf{Y}_0 = \mathbf{Y}_0^{ba}$, the general solution of (5.92) in $L^1_{\text{loc}}(\mathbb{R}^+)$ is $C^k \mathbf{Y}_k^{ba}$, $k \in \mathbb{N}^+$.

Comparing (5.127) with (5.114) we see that if $S \neq 0$ (which is the generic case), then the general solution on $(0, 2)$ of (5.89) is a linear combination of the upper and lower analytic continuations of $\mathcal{B}\tilde{\mathbf{y}}_0$:

$$\mathbf{Y}_C = \lambda_C \mathbf{Y}_0^+ + (1 - \lambda_C) \mathbf{Y}_0^- \tag{5.128}$$

Finally we mention the following result, which shows that the balanced average, like medianization [34], commutes with convolution.

Theorem 5.129 *If f and g are analytic in \mathcal{R}_1 , then $f * g$ extends analytically in \mathcal{R}_1 and furthermore,*

$$(f * g)^{ba} = f^{ba} * g^{ba} \tag{5.130}$$

As a consequence of the linearity of the balanced averaging and its commutation with convolution, if $\tilde{\mathbf{t}}_{1,2}$ are the transseries of the solutions $\mathbf{f}_{1,2}$ of differential equations of the type considered here and if $\mathcal{LB}\tilde{\mathbf{t}}_{1,2} = \mathbf{f}_{1,2}$, then

$$\mathcal{LB}(a\tilde{\mathbf{t}}_1 + b\tilde{\mathbf{t}}_2) = a\mathbf{f}_1 + b\mathbf{f}_2 \tag{5.131}$$

Moreover, what is less obvious, we have for the componentwise product formula

$$\mathcal{LB}(\tilde{\mathbf{t}}_1 \tilde{\mathbf{t}}_2) = \mathbf{f}_1 \mathbf{f}_2 \tag{5.132}$$

5.10d Comments

We look more carefully at the behavior along singular directions. As mentioned, at singular points, the convolution equations are to leading order linear, regularly perturbed, ODEs. In nonlinear equations, one singularity is replicated periodically along its complex direction, via autoconvolution.

The next task is to find a Borel summation valid along the singular directions while preserving all properties of usual Borel summation. The formulas are valid in the context of ODEs, where they offer simplicity, as well as complete classification of well-behaved averages, but do not substitute for the general averages of Écalle. The latter have the expected properties regardless of the origin of the expansion; see [33].

We first obtain the general solution in L^1_{loc} of the convolution system (5.92) in \mathcal{W} and then, separately, on the Stokes ray \mathbb{R}^+ . We show that along a ray in \mathcal{W} , the solution is unique whereas along the ray \mathbb{R}^+ there is a one-parameter family of solutions of the system, branching off at $p = 1$. We show that any L^1_{loc} solution of the system is exponentially bounded at infinity (uniformly in k). Therefore, the Laplace transforms exist and solve (5.51). Conversely, any solution of (5.51) with the required asymptotic properties is inverse Laplace transformable; therefore, it has to be one of the previously obtained solutions of the equation corresponding to $k = 0$. We then study

the regularity properties of the solutions of the convolution equation by local analysis.

Having the complete description of the family of L^1_{loc} solutions we compare different formulas for one given solution and obtain resurgence identities; resurgence, together with the local properties of the solutions, are instrumental in finding the analytic properties of \mathbf{Y}_k in \mathcal{R}_1 .

5.10e The convolution equation away from singular rays

We denote by $L_{1,1}(\mathcal{E})$ the set of functions which are locally integrable along each ray in \mathcal{E} (an intersection of usual L_1 spaces).

Proposition 5.133 *There is a unique solution of (5.89) in $L_{1,1}(\mathcal{W})$ namely $\mathbf{Y}_0 = \mathcal{B}\tilde{\mathbf{y}}_0$.*

This solution is analytic in \mathcal{W} , Laplace transformable along any ray $\arg p = \phi$ contained in \mathcal{W} and $\mathcal{L}_\phi \mathbf{Y}_0$ is a solution of (5.51).

For the proof we need a few more results.

Remark 5.134 *There is a constant $K > 0$ (independent of p and \mathbf{l}) so that for all $p \in \mathbb{C}$ and all $\mathbf{l} \geq \mathbf{0}$*

$$|\mathbf{G}_1(p)| \leq K c_0^{|\mathbf{l}|} e^{c_0|p|} \tag{5.135}$$

if $c_0 > \max\{x_0^{-1}, y_0^{-1}\}$.

PROOF From the analyticity assumption it follows that

$$|\mathbf{g}_{m,\mathbf{l}}| \leq \text{Const } c_0^{m+|\mathbf{l}|} \tag{5.136}$$

where the constant is independent on m and \mathbf{l} .

Then,

$$|\mathbf{G}_1(p)| \leq \text{Const } c_0^{|\mathbf{l}+1} \frac{e^{c_0|p|} - 1}{c_0|p|} \leq \text{Const } c_0^{|\mathbf{l}+1} e^{c_0|p|}$$

□

Consider the ray segments

$$\Phi_D = \{\alpha e^{i\phi} : 0 \leq \alpha \leq D\} \tag{5.137}$$

the L^1 norm with exponential weight along Φ_D

$$\|f\|_{\nu, \Phi} = \|f\|_{\nu} := \int_{\Phi} e^{-\nu|p|} |f(p)| |dp| = \int_0^D e^{-\nu t} |f(te^{i\phi})| dt \tag{5.138}$$

and the space

$$L^1_\nu(\Phi_D) := \{f : \|f\|_\nu < \infty\}$$

(if $D < \infty$, $L^1_\nu(\Phi_D) = L^1_{\text{loc}}(\Phi_D)$).

Let $\mathcal{K} \in \mathbb{C}$ be a bounded domain, $\text{diam}(\mathcal{K}) = D < \infty$. On the space of continuous functions on \mathcal{K} we take the uniform norm with exponential weight:

$$\|f\|_u := D \sup_{p \in \mathcal{K}} \{|f(p)|e^{-\nu|p|}\} \tag{5.139}$$

(which is equivalent to the usual uniform norm).

Let $\mathcal{O} \subset \mathcal{D}$, $\mathcal{O} \ni 0$ be a *star-shaped, open set*, $\text{diam}(\mathcal{O}) = D$ containing a ray segment Φ . Let \mathcal{A} be the space of analytic functions f in \mathcal{O} such that $f(0) = 0$, endowed with the norm (5.139).

Proposition 5.140 *The spaces $L^1_\nu(\Phi_D)$ and \mathcal{A} are focusing algebras; see §5.1 and §5.2.*

Corollary 5.141 *Let f be continuous along Φ_D , $D < \infty$ and $g \in L^1_\nu(\Phi_D)$. Given $\epsilon > 0$ there exists a large enough ν and $K = K(\epsilon, \Phi_D)$ so that for all k*

$$\|f * g^{*k}\|_u \leq K \epsilon^k$$

By Proposition 5.140 we can choose $\nu = \nu(\epsilon, \Phi_D)$ so large that $\|g\|_\nu \leq \epsilon$ (we make use of the focusing nature of the norm). Then, by Proposition 5.140 and Eq. (5.139) we have:

$$\begin{aligned} \left| \int_0^{pe^{i\phi}} f(pe^{i\phi} - s)g^{*k}(s)ds \right| &\leq D^{-1}e^{\nu|p|}\|f\|_u \int_0^{pe^{i\phi}} e^{-\nu|s|}|g^{*k}(s)||ds| \leq \\ &D^{-1}e^{\nu|p|}\|f\|_u\|g\|_\nu^k \leq K \epsilon^k \end{aligned}$$

□

Remark 5.142 *By (5.135), for any $\nu > c_0$, and $\Phi_D \subset \mathbb{C}$, $D \leq \infty$*

$$\|\mathbf{G}_1\|_\nu \leq Kc_0^{||} \int_0^\infty |dp|e^{|p|(c_0-\nu)} = K \frac{c_0^{||}}{\nu - c_0} \tag{5.143}$$

where we wrote

$$\mathbf{f} \in L^1_\nu(\Phi_D) \text{ iff } \|\mathbf{f}\|_\nu \in L^1_\nu(\Phi_D) \tag{5.144}$$

(and similarly for other norms of vector functions).

PROOF of Proposition 5.133 We first show existence and uniqueness in $L_{1,1}(\mathcal{W})$.

Then we show that for large enough ν there exists a unique solution of (5.89) in $L^1_\nu(\Phi_\infty)$. Since this solution is also in $L^1_{\text{loc}}(\Phi_\infty)$ it follows that our (unique) L^1_{loc} solution is Laplace transformable. Analyticity is proven by usual fixed point methods in a space of analytic functions. \square

Proposition 5.145 (i) For $\Phi_D \in \mathcal{W}$ and large enough ν , the operator

$$\mathcal{N}_1 := \mathbf{Y}(p) \mapsto (\hat{\Lambda} - p)^{-1} \left(\mathbf{F}_0(p) - \hat{B} \int_0^p \mathbf{Y}(s) ds + \mathcal{N}(\mathbf{Y})(p) \right) \tag{5.146}$$

is contractive in a small enough neighborhood of the origin with respect to $\|\cdot\|_u$ if $D < \infty$ and with respect to $\|\cdot\|_\nu$ for $D \leq \infty$.

(ii) For $D \leq \infty$ the operator \mathcal{N} given formally in (5.87) is continuous in $L^1_{\text{loc}}(\Phi_D)$. The last sum in (5.87) converges uniformly on compact subsets of Φ_D . $\mathcal{N}(L^1_{\text{loc}}(\Phi_D))$ is contained in the absolutely continuous functions on Φ_D [51]. Moreover, if $\mathbf{v}_n \rightarrow \mathbf{v}$ in $\|\cdot\|_\nu$ on Φ_D , $D \leq \infty$, then for $\nu' \geq \nu$ large enough, $\mathcal{N}(\mathbf{v}_n)$ exist and converge in $\|\cdot\|_{\nu'}$ to \mathbf{v} .

Here we make use of Remark 5.18 to obtain at the same time a number of needed properties of the solutions (analyticity, bounds at infinity, etc.).

The last statements in (ii) amount to saying that \mathcal{N} is continuous in the topology of the inductive limit of the L^1_ν .

PROOF Since $\hat{\Lambda}$ and \hat{B} are constant matrices we have

$$\|\mathcal{N}_1(\mathbf{Y})\|_{u,\nu} \leq \text{Const}(\Phi) (\|\mathbf{F}_0\|_{u,\nu} + \|\mathbf{Y}\|_{u,\nu} \|1\|_\nu + \|\mathcal{N}(\mathbf{Y})\|_{u,\nu}) \tag{5.147}$$

As both $\|1\|_\nu$ and $\|\mathbf{F}_0\|_{u,\nu}$ are $O(\nu^{-1})$ for large ν , the fact that \mathcal{N}_1 maps a small ball into itself follows from the following remark.

Remark 5.148 Let $\epsilon > 0$ be small enough. Then, there is a K so that for large ν and all \mathbf{v} such that $\|\mathbf{v}\|_{u,\nu} =: \delta < \epsilon$,

$$\|\mathcal{N}(\mathbf{v})\|_{u,\nu} \leq K (\nu^{-1} + \|\mathbf{v}\|_{u,\nu}) \|\mathbf{v}\|_{u,\nu} \tag{5.149}$$

By (5.136) and (5.143), for large ν and some positive constants C_1, \dots, C_5 ,

$$\begin{aligned} \|\mathcal{N}(\mathbf{v})\|_{u,\nu} &\leq C_1 \left(\sum_{|\mathbf{l}| \geq 1} \|\mathbf{G}_1\|_\nu \|\mathbf{v}\|_{u,\nu}^{|\mathbf{l}|} + \sum_{|\mathbf{l}| \geq 2} \|\mathbf{g}_{0,1}\|_\nu \|\mathbf{v}\|_{u,\nu}^{|\mathbf{l}|} \right) \\ &\leq \frac{C_2}{\nu} \left(\sum_{|\mathbf{l}| \geq 1} \frac{c_0^{|\mathbf{l}|}}{\nu - c_0} \delta^{|\mathbf{l}|} + \sum_{|\mathbf{l}| \geq 2} c_0^{|\mathbf{l}|} \delta^{|\mathbf{l}|} \right) \leq \left(C_2 \sum_{m=1}^\infty + \sum_{m=2}^\infty \right) c_0^m \delta^m \sum_{|\mathbf{l}|=m} 1 \\ &\leq \left(\frac{C_4}{\nu} + c_0 \delta \right) \sum_{m=1}^\infty c_0^m \delta^m (m+4)^n \leq \left(\frac{C_4}{\nu} + c_0 \delta \right) C_5 \delta \end{aligned} \tag{5.150}$$

□

To show that \mathcal{N}_1 is a contraction we need the following:

Remark 5.151

$$\|\mathbf{h}_1\| := \|(\mathbf{f} + \mathbf{h})^{*1} - \mathbf{f}^{*1}\| \leq |\mathbf{l}| (\|\mathbf{f}\| + \|\mathbf{h}\|)^{|\mathbf{l}|-1} \|\mathbf{h}\| \tag{5.152}$$

where $\|\cdot\| = \|\cdot\|_u$ or $\|\cdot\|_\nu$.

This estimate is useful when \mathbf{h} is a “small perturbation.” The proof of (5.152) is a simple induction on \mathbf{l} , with respect to the lexicographic ordering. For $|\mathbf{l}| = 1$, (5.152) is clear; assume (5.152) holds for all $\mathbf{l} < \mathbf{l}_1$ and that \mathbf{l}_1 differs from its predecessor \mathbf{l}_0 at the position k (we can take $k = 1$), i.e., $(\mathbf{l}_1)_1 = 1 + (\mathbf{l}_0)_1$. We have:

$$\begin{aligned} \|(\mathbf{f} + \mathbf{h})^{*1_1} - \mathbf{f}^{*1_1}\| &= \|(\mathbf{f} + \mathbf{h})^{*1_0} * (\mathbf{f}_1 + \mathbf{h}_1) - \mathbf{f}^{*1_1}\| = \\ &\|(\mathbf{f}^{*1_0} + \mathbf{h}_{1_0}) * (f_1 + h_1) - \mathbf{f}^{*1_1}\| = \|\mathbf{f}^{*1_0} * h_1 + \mathbf{h}_{1_0} * f_1 + \mathbf{h}_{1_0} * h_1\| \leq \\ &\|\mathbf{f}\|^{|\mathbf{l}_0|} \|\mathbf{h}\| + \|\mathbf{h}_{1_0}\| \|\mathbf{f}\| + \|\mathbf{h}_{1_0}\| \|\mathbf{h}\| \leq \\ &\|\mathbf{h}\| \left(\|\mathbf{f}\|^{|\mathbf{l}_0|} + |\mathbf{l}_0| (\|\mathbf{f}\| + \|\mathbf{h}\|)^{|\mathbf{l}_0|} \right) \leq \\ &\|\mathbf{h}\| (|\mathbf{l}_0| + 1) (\|\mathbf{f}\| + \|\mathbf{h}\|)^{|\mathbf{l}_0|} \end{aligned} \tag{5.153}$$

Remark 5.154 For small δ and large enough ν , \mathcal{N}_1 defined in a ball of radius δ centered at zero, is contractive in the norms $\|\cdot\|_{u,\nu}$.

By (5.147) and (5.149) we know that the ball is mapped into itself for large ν . Let $\epsilon > 0$ be small and let \mathbf{f}, \mathbf{h} be so that $\|\mathbf{f}\| < \delta - \epsilon$, $\|\mathbf{h}\| < \epsilon$. Using (5.152) and the notations (5.89), (5.147) and $\|\cdot\| = \|\cdot\|_{u,\nu}$ we obtain, for some positive constants C_1, \dots, C_4 and large ν ,

$$\begin{aligned} \|\mathcal{N}_1(\mathbf{f} + \mathbf{h}) - \mathcal{N}_1(\mathbf{f})\| &\leq C_1 \left\| \left(\sum_{|\mathbf{l}| \geq 2} \mathbf{g}_{0,1} \cdot + \sum_{|\mathbf{l}| \geq 1} \mathbf{G}_1^* \right) ((\mathbf{f} + \mathbf{h})^{*1} - \mathbf{f}^{*1}) \right\| \leq \\ &C_2 \|\mathbf{h}\| \left(\sum_{|\mathbf{l}| \geq 1} \frac{c_0^{|\mathbf{l}|}}{\nu - c_0} |\mathbf{l}| \delta^{|\mathbf{l}|-1} + \sum_{|\mathbf{l}| \geq 2} |\mathbf{l}| c_0^{|\mathbf{l}|} \delta^{|\mathbf{l}|-1} \right) \leq (C_3 \nu^{-1} + C_4 \delta) \|\mathbf{h}\| \end{aligned} \tag{5.155}$$

To finish the proof of Proposition 5.145 take $\mathbf{v} \in \mathcal{A}$. Given $\epsilon > 0$ we can choose ν large enough (by Proposition 5.140) to make $\|\mathbf{v}\|_u < \epsilon$. Then the sum in the formal definition of \mathcal{N} is convergent in \mathcal{A} , by (5.150). Now, if $D < \infty$, then $L_{\text{loc}}^1(\Phi_D) = L_\nu^1(\Phi_D)$ for any $\nu > 0$. If $\mathbf{v}_n \rightarrow \mathbf{v}$ in $L_\nu^1(\Phi_D)$, we choose ϵ small enough, then ν large so that $\|\mathbf{v}\|_\nu < \epsilon$, and finally n_0 large so that for $n > n_0$ $\|\mathbf{v}_n - \mathbf{v}\|_\nu < \epsilon$ (note that $\|\cdot\|_\nu$ decreases w.r. to ν) thus $\|\mathbf{v}_n\|_\nu < 2\epsilon$ and continuity (in $L_\nu^1(\Phi_D)$ as well as in $L_{\text{loc}}^1(\Phi_\infty) \equiv \cup_{k \in \Phi_\infty} L_\nu^1(0, k)$) follows from Remark 5.154. Continuity with respect to the topology of the inductive limit of the L_ν^1 is proven in the same way. It is straightforward to show that $\mathcal{N}(L_{\text{loc}}^1(\Phi)) \subset C_a(\Phi)$, where C_a are absolutely continuous functions [51]. □

The fact that $\mathcal{L}_\phi \mathbf{Y}_0$ is a solution of (5.51) follows from Proposition 5.145 and the properties of \mathcal{L} (see also the proof of Proposition 5.212).

Since $\mathbf{Y}_0(p)$ is analytic for small p , $(\mathcal{L}\mathbf{Y}_0)(x)$ has an asymptotic series for large x , which has to agree with $\tilde{\mathbf{y}}_0$ since $\mathcal{L}\mathbf{Y}_0$ solves (5.51). This shows that $\mathbf{Y}_0 = \mathcal{B}\tilde{\mathbf{y}}_0$. □

Remark 5.156 For any δ there is a constant $K_2 = K_2(\delta, |p|)$ so that for all l we have

$$|\mathbf{Y}_0^{*1}(p)| \leq K_2 \delta^{|\mathbf{l}|} \tag{5.157}$$

The estimates (5.157) follow immediately from analyticity and from Corollary 5.141. □

5.10f Behavior of $\mathbf{Y}_0(p)$ near $p = 1$

The point $p = 1$ is a singular point of the convolution equation. The solution is generally singular too. Its behavior at the singularity is derived using the convolution equation alone.

*

Let \mathbf{Y}_0 be the unique solution in $L_{1,1}(\mathcal{W})$ of (5.89) and let $\epsilon > 0$ be small. Define

$$\mathbf{H}(p) := \begin{cases} \mathbf{Y}_0(p) & \text{for } p \in \mathcal{W}, |p| < 1 - \epsilon \\ 0 & \text{otherwise} \end{cases} \quad \text{and} \quad \mathbf{h}(1-p) := \mathbf{Y}_0(p) - \mathbf{H}(p) \tag{5.158}$$

In terms of \mathbf{h} , for real $z = 1 - p, z < \epsilon$, the equation (5.89) reads:

$$-(1-z)\mathbf{h}(z) = \mathbf{F}_1(z) - \hat{\Lambda}\mathbf{h}(z) + \hat{B} \int_{\epsilon}^z \mathbf{h}(s)ds + \mathcal{N}(\mathbf{H} + \mathbf{h}) \tag{5.159}$$

where

$$\mathbf{F}_1(1-s) := \mathbf{F}_0(s) - \hat{B} \int_0^{1-\epsilon} \mathbf{H}(s)ds$$

Proposition 5.160 *For small ϵ , $\mathbf{H}^{*1}(1+z)$ extends to an analytic function in the disk $\mathbb{D}_{\epsilon} := \{z : |z| < \epsilon\}$. Furthermore, for any δ there is an ϵ and a constant $K_1 := K_1(\delta, \epsilon)$ so that for $z \in \mathbb{D}_{\epsilon}$ the analytic continuation satisfies the estimate*

$$|\mathbf{H}^{*1}(1+z)| < K_1\delta^l \tag{5.161}$$

PROOF The case $|l| = 1$ is clear: \mathbf{H} itself extends as the zero analytic function. We assume by induction on $|l|$ that Proposition 5.160 is true for all $l, |l| \leq l$ and show that it then holds for (e.g.) $H_1 * \mathbf{H}^{*1}$, for all $l, |l| \leq l$.

\mathbf{H} is analytic in an ϵ -neighborhood of $[0, 1 - 2\epsilon]$, and therefore so is \mathbf{H}^{*1} . Taking first $z \in \mathbb{R}^+, z < \epsilon$, we have

$$\begin{aligned} \int_0^{1-z} H_1(s)\mathbf{H}^{*1}(1-z-s)ds &= \int_0^{1-\epsilon} H_1(s)\mathbf{H}^{*1}(1-z-s)ds = \\ &= \int_0^{1/2} H_1(s)\mathbf{H}^{*1}(1-z-s)ds + \int_{1/2}^{1-\epsilon} H_1(s)\mathbf{H}^{*1}(1-z-s)ds \end{aligned} \tag{5.162}$$

The integral on $[1/2, 1 - \epsilon]$ is analytic for small z , since the argument of \mathbf{H}^{*1} varies in an ϵ -neighborhood of $[0, 1/2]$; the integral on $[0, 1/2]$ equals

$$\int_{1/2-z}^{1-z} H_1(1-z-t)\mathbf{H}^{*1}(t)dt = \left(\int_{1/2-z}^{1/2} + \int_{1/2}^{1-\epsilon} + \int_{1-\epsilon}^{1-z} \right) H_1(1-z-t)\mathbf{H}^{*1}(t)dt \tag{5.163}$$

In (5.163) the integral on $[1/2 - z, 1/2]$ is clearly analytic in \mathbb{D}_ϵ , the second one is the integral of an analytic function of the parameter z with respect to the absolutely continuous measure $\mathbf{H}^{*1}dt$ whereas in the last integral, both \mathbf{H}^{*1} (by induction) and H_1 extend analytically in \mathbb{D}_ϵ .

To prove now the induction step for the estimate (5.161), fix δ small and let:

$$\eta < \delta; M_1 := \max_{|p| < 1/2 + \epsilon} |\mathbf{H}(p)|; M_2(\epsilon) := \max_{0 \leq x \leq 1 - \epsilon} |\mathbf{H}(p)|; \epsilon < \frac{\delta}{4M_1} \tag{5.164}$$

Let $K_2 := K_2(\eta; \epsilon)$ be large enough so that (5.157) holds with η in place of δ for real $x \in [0, 1 - \epsilon]$ and also in an ϵ neighborhood in \mathbb{C} of the interval $[0, 1/2 + 2\epsilon]$. We use (5.157) to estimate the second integral in the decomposition (5.162) and the first two integrals on the right side of (5.163). For the last integral in (5.163) we use the induction hypothesis. If $K_1 > 2K_2(2M_1 + M_2)$, it follows that $|\mathbf{H}^{*1} * H_1|$ is bounded by (the terms are in the order explained above):

$$M_2(\epsilon)K_2\eta^l + M_1K_2\eta^l + M_1K_2\eta^l + (2\epsilon)M_1K_1\delta^l < K_1\delta^{l+1} \tag{5.165}$$

□

Proposition 5.166 *The equation (5.159) can be written as*

$$-(1-z)\mathbf{h}(z) = \mathbf{F}(z) - \hat{\Lambda}\mathbf{h}(z) + \hat{B} \int_\epsilon^z \mathbf{h}(s)ds - \sum_{j=1}^n \int_\epsilon^z h_j(s)\mathbf{D}_j(s-z)ds \tag{5.167}$$

where

$$\mathbf{F}(z) := \mathcal{N}(\mathbf{H})(1-z) + \mathbf{F}_1(z) \tag{5.168}$$

$$\mathbf{D}_j = \sum_{|\mathbf{l}| \geq 1} l_j \mathbf{G}_1 * \mathbf{H}^{*\bar{\mathbf{l}}^j} + \sum_{|\mathbf{l}| \geq 2} l_j \mathbf{g}_{0,1} \mathbf{H}^{*\bar{\mathbf{l}}^j}; \bar{\mathbf{l}}^j := (l_1, l_2, \dots, (l_j - 1), \dots, l_n) \tag{5.169}$$

extend to analytic functions in \mathbb{D}_ϵ (cf. Proposition 5.160). Moreover, if \mathbf{H} is a vector in $L^1_\nu(\mathbb{R}^+)$ then, for large ν , $\mathbf{D}_j \in L^1_\nu(\mathbb{R}^+)$ and the functions $\mathbf{F}(z)$ and \mathbf{D}_j extend to analytic functions in \mathbb{D}_ϵ .

PROOF Noting that $(\mathbf{Y}_0 - \mathbf{H})^{*2}(1-z) = 0$ for $\epsilon < 1/2$ and $z \in \mathbb{D}_\epsilon$ the result is easily obtained by re-expanding $\mathcal{N}(\mathbf{H} + \mathbf{h})$ since Proposition 5.160 guarantees the uniform convergence of the series thus obtained. The

proof that $\mathbf{D}_j \in L_\nu^1$ for large ν is very similar to the proof of (5.155). The analyticity properties follow easily from Proposition 5.160, since the series involved in $\mathcal{N}(\mathbf{H})$ and \mathbf{D}_j converge uniformly for $|z| < \epsilon$. \square

Consider again the equation (5.167). Let $\hat{\Gamma} = \hat{\Lambda} - (1 - z)\hat{1}$, where $\hat{1}$ is the identity matrix. By construction $\hat{\Gamma}$ and \hat{B} are block-diagonal, their first block is one-dimensional: $\hat{\Gamma}_{11} = z$ and $\hat{B}_{11} = \beta$. We write this as $\hat{\Gamma} = z \oplus \hat{\Gamma}_c(z)$ and similarly, $\hat{B} = \beta \oplus \hat{B}_c$, where $\hat{\Gamma}_c$ and \hat{B}_c are $(n - 1) \times (n - 1)$ matrices. $\hat{\Gamma}_c(z)$ and $\hat{\Gamma}_c^{-1}(z)$ are analytic in \mathbb{D}_ϵ .

Lemma 5.170 *The function \mathbf{Y}_0 given in Proposition 5.133 can be written in the form*

$$\begin{aligned} \mathbf{Y}_0(p) &= (1 - p)^{\beta-1} \mathbf{a}_1(p) + \mathbf{a}_2(p) \quad (\beta \neq 1) \\ \mathbf{Y}_0(p) &= \ln(1 - p) \mathbf{a}_1(p) + \mathbf{a}_2(p) \quad (\beta = 1) \end{aligned} \quad (5.171)$$

for p in the region $(\mathbb{D}_\epsilon + 1) \cap \mathcal{W}$, where $\mathbb{D}_\epsilon + 1 := \{1 + z : z \in \mathbb{D}_\epsilon\}$ and where $\mathbf{a}_1, \mathbf{a}_2$ are analytic functions in $\mathbb{D}_\epsilon + 1$ and $(\mathbf{a}_1)_j = 0$ for $j > 1$.

Proof.

Let $\mathbf{Q}(z) := \int_\epsilon^z \mathbf{h}(s) ds$. By Proposition 5.133, \mathbf{Q} is analytic in $\mathbb{D}_\epsilon \cap (1 - \mathcal{W})$. From (5.167) we obtain

$$(z \oplus \hat{\Gamma}_c(z)) \mathbf{Q}'(z) - (\beta \oplus \hat{B}_c) \mathbf{Q}(z) = \mathbf{F}(z) - \sum_{j=1}^n \int_\epsilon^z \mathbf{D}_j(s - z) Q'_j(s) ds \quad (5.172)$$

or, after integration by parts in the right side of (5.172), ($\mathbf{D}_j(0) = 0$, cf. (5.169)),

$$(z \oplus \hat{\Gamma}_c(z)) \mathbf{Q}'(z) - (\beta \oplus \hat{B}_c) \mathbf{Q}(z) = \mathbf{F}(z) + \sum_{j=1}^n \int_\epsilon^z \mathbf{D}'_j(s - z) Q_j(s) ds \quad (5.173)$$

With the notation $(Q_\perp, \mathbf{Q}_\perp) := (Q_1, Q_2, \dots, Q_n)$ we write the system in the form

$$\begin{aligned}
 (z^{-\beta}Q_1(z))' &= z^{-\beta-1} \left(F_1(z) + \sum_{j=1}^n \int_{\epsilon}^z D'_{1j}(s-z)Q_j(s)ds \right) \\
 (e^{\hat{C}(z)}\mathbf{Q}_{\perp})' &= e^{\hat{C}(z)}\hat{\Gamma}_c(z)^{-1} \left(\mathbf{F}_{\perp} + \sum_{j=1}^n \int_{\epsilon}^z \mathbf{D}'_{\perp}(s-z)Q_j(s)ds \right) \\
 \hat{C}(z) &:= - \int_0^z \hat{\Gamma}_c(s)^{-1}\hat{B}_c(s)ds \\
 \mathbf{Q}(\epsilon) &= 0 \quad (5.174)
 \end{aligned}$$

After integration we get:

$$\begin{aligned}
 Q_1(z) &= R_1(z) + J_1(\mathbf{Q}) \\
 \mathbf{Q}_{\perp}(z) &= \mathbf{R}_{\perp}(z) + J_{\perp}(\mathbf{Q}) \quad (5.175)
 \end{aligned}$$

with

$$\begin{aligned}
 J_1(\mathbf{Q}) &= z^{\beta} \int_{\epsilon}^z t^{-\beta-1} \sum_{j=1}^n \int_{\epsilon}^t Q_j(s)D'_{1j}(t-s)dsdt \\
 J_{\perp}(\mathbf{Q})(z) &:= e^{-\hat{C}(z)} \int_{\epsilon}^z e^{\hat{C}(t)}\hat{\Gamma}_c(t)^{-1} \left(\sum_{j=1}^n \int_{\epsilon}^z \mathbf{D}'_{\perp}(s-z)Q_j(s)ds \right) dt \\
 \mathbf{R}_{\perp}(z) &:= e^{-\hat{C}(z)} \int_{\epsilon}^z e^{\hat{C}(t)}\hat{\Gamma}_c(t)^{-1}\mathbf{F}_{\perp}(t)dt \\
 R_1(z) &= z^{\beta} \int_{\epsilon}^z t^{-\beta-1}F_1(t)dt \quad (\beta \neq 1) \\
 R_1(z) &= F_1(0) + F'_1(0)z \ln z + z \int_{\epsilon}^z \frac{F_1(s) - F_1(0) - sF'_1(0)}{s} ds \quad (\beta = 1)
 \end{aligned} \tag{5.176}$$

Consider the following space of functions:

$$\begin{aligned}
 \mathcal{Q}_{\beta} &= \left\{ \mathbf{Q} \text{ analytic in } \mathbb{D}_{\epsilon} \cap (\mathcal{W} - 1) : \mathbf{Q} = z^{\beta}\mathbf{A}(z) + \mathbf{B}(z) \right\} \text{ for } \beta \neq 1 \text{ and} \\
 \mathcal{Q}_{1+} &= \left\{ \mathbf{Q} \text{ analytic in } \mathbb{D}_{\epsilon} \cap (\mathcal{W} - 1) : \mathbf{Q} = z \ln z\mathbf{A}(z) + \mathbf{B}(z) \right\} \quad (5.177)
 \end{aligned}$$

where \mathbf{A}, \mathbf{B} are analytic in \mathbb{D}_{ϵ} . (The decomposition of \mathbf{Q} in (5.177) is unambiguous since z^{β} and $z \ln z$ are not meromorphic in \mathbb{D}_{ϵ} .)

The norm

$$\|\mathbf{Q}\| = \sup \{|\mathbf{A}(z)|, |\mathbf{B}(z)| : z \in \mathbb{D}_\epsilon\} \tag{5.178}$$

makes \mathcal{Q}_β a Banach space.

For $A(z)$ analytic in \mathbb{D}_ϵ the following elementary identities are useful in what follows:

$$\begin{aligned} \int_\epsilon^z A(s)s^r ds &= Const + z^{r+1} \int_0^1 A(z)t^r dt = Const + z^{r+1} A_1(z) \\ \int_0^z s^r \ln s A(s) ds &= z^{r+1} \ln z \int_0^1 A(z)t^r dt + z^{r+1} \int_0^1 A(z)t^r \ln t dt \end{aligned} \tag{5.179}$$

where A_1 is analytic and the second equality is obtained by differentiating with respect to r the first equality.

Using (5.179) it is straightforward to check that the right side of (5.175) extends to a linear inhomogeneous operator on \mathcal{Q}_β with image in \mathcal{Q}_β and that the norm of J is $O(\epsilon)$ for small ϵ . For instance, one of the terms in J for $\beta = 1$,

$$\begin{aligned} z \int_0^z t^{-2} \int_0^t s \ln s A(s) D'(t-s) ds = \\ z^2 \ln z \int_0^1 \int_0^1 \sigma A(z\tau\sigma) D'(z\tau - z\tau\sigma) d\sigma d\tau + \\ z^2 \int_0^1 d\tau \int_0^1 d\sigma (\ln \tau + \ln \sigma) A(z\tau\sigma) D'(z\tau - z\tau\sigma) \end{aligned} \tag{5.180}$$

manifestly in \mathcal{Q}_β if A is analytic in \mathbb{D}_ϵ . Comparing with (5.177), the extra power of z accounts for a norm $O(\epsilon)$ for this term.

Therefore, in (5.174) $(1 - J)$ is invertible and the solution $\mathbf{Q} \in \mathcal{Q}_\beta \subset \mathcal{L}(\mathcal{D})$. In view of the uniqueness of \mathbf{Y}_0 (cf. Proposition 5.133), the rest of the proof of Lemma 5.170 is immediate.

5.10g General solution of (5.89) on $[0, 1 + \epsilon]$

Let \mathbf{Y}_0 be the solution given by Proposition 5.133, take ϵ small enough and denote by \mathcal{O}_ϵ a neighborhood in \mathbb{C} of width ϵ of the interval $[0, 1 + \epsilon]$.

Remark 5.181 $\mathbf{Y}_0 \in L^1(\mathcal{O}_\epsilon)$. As $\phi \rightarrow \pm 0$, $\mathbf{Y}_0(pe^{i\phi}) \rightarrow \mathbf{Y}_0^\pm(p)$ in the sense of $L^1([0, 1 + \epsilon])$ and also in the sense of pointwise convergence for $p \neq 1$, where

$$\mathbf{Y}_0^\pm := \begin{cases} \mathbf{Y}_0(p) & p < 1 \\ (1 - p \pm 0i)^{\beta-1} \mathbf{a}_1(p) + \mathbf{a}_2(p) & p > 1 \end{cases} \quad (\beta \neq 1)$$

$$\mathbf{Y}_0^\pm := \begin{cases} \mathbf{Y}_0(p) & p < 1 \\ \ln(1 - p \pm 0i) \mathbf{a}_1(p) + \mathbf{a}_2(p) & p > 1 \end{cases} \quad (\beta = 1) \quad (5.182)$$

Moreover, \mathbf{Y}_0^\pm are L_{loc}^1 solutions of the convolution equation (5.89) on the interval $[0, 1 + \epsilon]$.

The proof is immediate from Lemma 5.170 and Proposition 5.145. □

Proposition 5.183 For any $\lambda \in \mathbb{C}$ the combination $\mathbf{Y}_\lambda = \lambda \mathbf{Y}_0^+ + (1 - \lambda) \mathbf{Y}_0^-$ is a solution of (5.89) on $[0, 1 + \epsilon]$.

Proof. For $p \in [0, 1) \cup (1, 1 + \epsilon]$ let $\mathbf{y}_\lambda(p) := \mathbf{Y}_\lambda - \mathbf{H}(p)$. Since $\mathbf{y}_\lambda^{*2} = 0$ the equation (5.89) is actually linear in \mathbf{y}_λ (compare with (5.167)). □

*

Note: We consider the application $\mathcal{B}_\lambda := \tilde{\mathbf{y}}_0 \mapsto \mathbf{Y}_\lambda$ and require that it be compatible with complex conjugation of functions $\mathcal{B}_\lambda(\tilde{\mathbf{y}}_0^*) = (\mathcal{B}_\lambda(\tilde{\mathbf{y}}_0))^*$ where $F^*(z) := \overline{F(\bar{z})}$. We get $\text{Re } \lambda = 1/2$. It is natural to choose $\lambda = 1/2$ to make the linear combination a true average. This choice corresponds, on $[0, 1 + \epsilon]$, to the balanced averaging (5.118).

*

Remark 5.184 For any $\delta > 0$ there is a constant $C(\delta)$ so that for large ν

$$\|(\mathbf{Y}_0^{ba})^{*1}\|_u < C(\delta) \delta^{|\mathbf{l}|} \quad \forall \mathbf{l} \text{ with } |\mathbf{l}| > 1 \quad (5.185)$$

(here $\|\cdot\|_u$ is taken on the interval $[0, 1 + \epsilon]$).

Without loss of generality, assume that $l_1 > 1$. Using the notation (5.169) we get

$$\left\| \int_0^p (\mathbf{Y}_0^{ba})_1(s) (\mathbf{Y}_0^{ba})^{*1}(p-s) ds \right\|_u \leq \left\| \int_0^{\frac{p}{2}} (\mathbf{Y}_0^{ba})_1(s) (\mathbf{Y}_0^{ba})^{*1}(p-s) ds \right\|_{u_2} + \left\| \int_0^{\frac{p}{2}} (\mathbf{Y}_0)_1(p-s) (\mathbf{Y}_0^{ba})^{*1}(s) ds \right\|_{u_2} \quad (5.186)$$

($\|\cdot\|_{u_2}$ refers to the interval $p \in [0, 1/2 + \epsilon/2]$.) The first u_2 norm can be estimated directly using Corollary 5.141, whereas we majorize the second one by

$$\|(\mathbf{Y}_0^{ba})_1\|_\nu \|(\mathbf{Y}_0^{ba})^{*1}(x)\|_{u_2}$$

and apply Corollary 5.141 to it for $|\mathbf{l}| > 2$ (if $|\mathbf{l}| = 2$ simply observe that $(\mathbf{Y}_0^{ba})^{*1}$ is analytic on $[0, 1/2 + \epsilon/2]$). □

Lemma 5.187 *The set of all solutions of (5.89) in $L_{\text{loc}}^1([0, 1 + \epsilon])$ is parameterized by a complex constant C and is given by*

$$\mathbf{Y}_0(p) = \begin{cases} \mathbf{Y}_0^{ba}(p) & \text{for } p \in [0, 1) \\ \mathbf{Y}_0^{ba}(p) + C(p-1)^{\beta-1}\mathbf{A}(p) & \text{for } p \in (1, 1 + \epsilon] \end{cases} \quad (5.188)$$

for $\beta \neq 1$ or, for $\beta = 1$,

$$\mathbf{Y}_0(p) = \begin{cases} \mathbf{Y}_0^{ba}(p) & \text{for } p \in [0, 1) \\ \mathbf{Y}_0^{ba}(p) + C(p-1)\mathbf{A}(p) & \text{for } p \in (1, 1 + \epsilon] \end{cases} \quad (5.188')$$

where \mathbf{A} extends analytically in a neighborhood of $p = 1$.

Different values of C correspond to different solutions.

This result remains true if \mathbf{Y}_0^{ba} is replaced by any other combination $\mathbf{Y}_\lambda := \lambda\mathbf{Y}_0^+ + (1 - \lambda)\mathbf{Y}_0^-$, $\lambda \in \mathbb{C}$.

Proof.

We look for solutions of (5.89) in the form

$$\mathbf{Y}^{ba}(p) + \mathbf{h}(p-1) \quad (5.189)$$

From Lemma 5.170 it follows that $\mathbf{h}(p-1) = 0$ for $p < 1$. Note that

$$\mathcal{N}(\mathbf{Y}_0^{ba} \circ \tau_{-1} + \mathbf{h})(z) = \mathcal{N}(\mathbf{Y}_0^{ba})(1+z) + \sum_{j=1}^n \int_0^z h_j(s)\mathbf{D}_j(z-s)ds \quad (5.190)$$

where the \mathbf{D}_j are given in (5.169), and by Remark 5.185 all infinite sums involved are uniformly convergent. For $z < \epsilon$ (5.89) translates into (compare with (5.167)):

$$-(1+z)\mathbf{h}(z) = -\hat{\Lambda}\mathbf{h}(z) - \hat{B} \int_0^z \mathbf{h}(s)ds + \sum_{j=1}^n \int_0^z h_j(s)\mathbf{D}_j(z-s)ds \quad (5.191)$$

Let

$$\mathbf{Q}(z) := \int_0^z \mathbf{h}(s)ds \quad (5.192)$$

As we are looking for solutions $\mathbf{h} \in L^1$, we have $\mathbf{Q} \in C_a[0, \epsilon]$, and $\mathbf{Q}(0) = 0$. Following the same steps as in the proof of Lemma 5.170 we get the system of equations:

$$\begin{aligned}
 (z^{-\beta} Q_1(z))' &= z^{-\beta-1} \sum_{j=1}^n \int_0^z D'_{1j}(z-s) Q_j(s) ds \\
 (e^{\hat{C}(z)} \mathbf{Q}_\perp)' &= e^{\hat{C}(z)} \hat{\Gamma}_c(z)^{-1} \sum_{j=1}^n \int_0^z \mathbf{D}'_\perp(z-s) Q_j(s) ds \\
 \hat{C}(z) &:= - \int_0^z \hat{\Gamma}_c(s)^{-1} \hat{B}_c(s) ds \\
 \mathbf{Q}(0) &= 0 \tag{5.193}
 \end{aligned}$$

which by integration gives

$$(\hat{1} + J)\mathbf{Q}(z) = C\mathbf{R}(z) \tag{5.194}$$

where $C \in \mathbb{C}$ and

$$\begin{aligned}
 (J(\mathbf{Q}))_1(z) &= z^\beta \int_0^z t^{-\beta-1} \sum_{j=1}^n \int_0^t Q_j(s) D'_{1j}(t-s) ds dt \\
 J(\mathbf{Q})_\perp(z) &:= e^{-\hat{C}(z)} \int_0^z e^{\hat{C}(t)} \hat{\Gamma}_c(t)^{-1} \left(\sum_{j=1}^n \int_0^z \mathbf{D}'_\perp(z-s) Q_j(s) ds \right) dt \\
 \mathbf{R}_\perp &= 0 \\
 R_1(z) &= z^\beta \\
 \tag{5.195}
 \end{aligned}$$

First we note the presence of an arbitrary constant C in (5.194) (Unlike in Lemma 5.170 when the initial condition, given at $z = \epsilon$ was determining the integration constant, now the initial condition $\mathbf{Q}(0) = 0$ is satisfied for all C).

For small ϵ the norm of the operator J defined on $C_a[0, \epsilon]$ is $O(\epsilon)$, as in the proof of Lemma 5.170. Given C the solution of the system (5.193) is unique and can be written as

$$\mathbf{Q} = C\mathbf{Q}_0; \quad \mathbf{Q}_0 := (\hat{1} + J)^{-1}\mathbf{R} \neq 0 \tag{5.196}$$

It remains to find the analytic structure of \mathbf{Q}_0 . We now introduce the space

$$\mathcal{Q} = \{ \mathbf{Q} : [0, \epsilon) \mapsto \mathbb{C}^n : \mathbf{Q} = z^\beta \mathbf{A}(z) \} \tag{5.197}$$

where $\mathbf{A}(z)$ extends to an analytic function in \mathbb{D}_ϵ . With the norm (5.178) (with $\mathbf{B} \equiv \mathbf{0}$), \mathcal{Q} is a Banach space. As in the proof of Lemma 5.170 the

operator J extends naturally to \mathcal{Q} where it has a norm $O(\epsilon)$ for small ϵ . It follows immediately that

$$\mathbf{Q}_0 \in \mathcal{Q} \tag{5.198}$$

The formulas (5.188) and (5.188') follow from (5.189) and (5.192). □

Remark 5.199 *If $S_\beta \neq 0$ (cf. Lemma 5.170) then the general solution of (5.89) is given by*

$$\mathbf{Y}_0(p) = (1 - \lambda)\mathbf{Y}_0^+(p) + \lambda\mathbf{Y}_0^-(p) \tag{5.200}$$

with $\lambda \in \mathbb{C}$.

Indeed, if $\mathbf{a}_1 \neq 0$ (cf. Lemma 5.170) we get at least two distinct solutions of (5.194) (i.e., two distinct values of C) by taking different values of λ in (5.200). The remark follows from (5.197), (5.198) and Lemma 5.187. □

5.10h The solutions of (5.89) on $[0, \infty)$

In this section we show that the leading asymptotic behavior of \mathbf{Y}_p as $p \rightarrow 1^+$ determines a unique solution of (5.89) in $L^1_{\text{loc}}(\mathbb{R}^+)$. Furthermore, any L^1_{loc} solution of (5.89) is exponentially bounded at infinity and thus Laplace transformable. We also study some properties of these solutions and of their Laplace transforms.

Let $\check{\mathbf{Y}}$ be a solution of (5.89) on an interval $[0, 1 + \epsilon]$, which we extend to \mathbb{R}^+ letting $\check{\mathbf{Y}}(\mathbf{p}) = \mathbf{0}$ for $p > 1 + \epsilon$. For a large enough ν , define

$$\mathcal{S}_{\check{\mathbf{Y}}} := \{\mathbf{f} \in L^1_{\text{loc}}([0, \infty)) : \mathbf{f}(p) = \check{\mathbf{Y}}(p) \text{ on } [0, 1 + \epsilon]\} \tag{5.201}$$

and

$$\mathcal{S}_0 := \{\mathbf{f} \in L^1_{\text{loc}}([0, \infty)) : \mathbf{f}(p) = 0 \text{ on } [0, 1 + \epsilon]\} \tag{5.202}$$

We extend $\check{\mathbf{Y}}$ to \mathbb{R}^+ by setting $\check{\mathbf{Y}}(p) = 0$ for $p > 1 + \epsilon$. For $p \geq 1 + \epsilon$ (5.89) reads:

$$-p(\check{\mathbf{Y}} + \delta) = F_0 - \hat{\Lambda}(\check{\mathbf{Y}} + \delta) - \hat{B} \int_0^p (\check{\mathbf{Y}} + \delta)(s)ds + \mathcal{N}(\check{\mathbf{Y}} + \delta) \tag{5.203}$$

with $\delta \in \mathcal{S}_0$, or

$$\delta = -\check{\mathbf{Y}} + (\hat{\Lambda} - p)^{-1} \left(F_0 - \hat{B} \int_0^p (\check{\mathbf{Y}} + \delta)(s)ds + \mathcal{N}(\check{\mathbf{Y}} + \delta) \right) := \mathcal{M}(\delta) \tag{5.204}$$

For small $\phi_0 > 0$ and $0 \leq \rho_1 < \rho_2 \leq \infty$, consider the truncated sectors

$$S_{(\rho_1, \rho_2)}^\pm := \{z : z = \rho e^{\pm i\phi}, \rho_1 < \rho < \rho_2; 0 \leq \phi < \phi_0\} \tag{5.205}$$

and the spaces of functions analytic in $S_{(\rho_1, \rho_2)}^\pm$ and continuous in its closure:

$$\mathcal{Q}_{\rho_1, \rho_2}^\pm = \left\{ \mathbf{f} : \mathbf{f} \in C(\overline{S_{(\rho_1, \rho_2)}^\pm}); \mathbf{f} \text{ analytic in } S_{(\rho_1, \rho_2)}^\pm \right\} \tag{5.206}$$

which are Banach spaces with respect to $\| \cdot \|_u$ on compact subsets of $\overline{S_{(\rho_1, \rho_2)}^\pm}$.

Proposition 5.207 (i) Given $\check{\mathbf{Y}}$, the equation (5.204) has a unique solution in $L_{\text{loc}}^1[1 + \epsilon, \infty)$. For large ν , this solution is in $L_\nu^1([1 + \epsilon, \infty))$ and thus Laplace transformable.

(ii) Let \mathbf{Y}_0 be the solution defined in Proposition 5.133. Then

$$\mathbf{Y}_0^\pm(p) := \lim_{\phi \rightarrow \pm 0} \mathbf{Y}_0(p e^{i\phi}) \in C(\mathbb{R}^+ \setminus \{1\}) \cap L_{\text{loc}}^1(\mathbb{R}^+) \tag{5.208}$$

(and the limit exists pointwise on $\mathbb{R}^+ \setminus \{1\}$ and in $L_{\text{loc}}^1(\mathbb{R}^+)$.)

Furthermore, \mathbf{Y}_0^\pm are particular solutions of (5.89) and

$$\begin{aligned} \mathbf{Y}_0^\pm(p) &= (1 - p)^{\beta-1} \mathbf{a}^\pm(p) + \mathbf{a}_1^\pm(p) \quad (\beta \neq 1) \\ \mathbf{Y}_0^\pm(p) &= \ln(1 - p) \mathbf{a}^\pm(p) + \mathbf{a}_1^\pm(p) \quad (\beta = 1) \end{aligned} \tag{5.209}$$

where \mathbf{a}^\pm and \mathbf{a}_1^\pm are analytic near $p = 1$.

Proof (i) Note first that by Proposition 5.145, \mathcal{M} (Eq. (5.204)) is well defined on \mathcal{S}_0 , (Eq. (5.202)). Moreover, since $\check{\mathbf{Y}}$ is a solution of (5.89) on $[0, 1 + \epsilon)$, we have, for $\delta_0 \in \mathcal{S}_0$, $\mathcal{M}(\delta) = 0$ a.e. on $[0, 1 + \epsilon)$, i.e.,

$$\mathcal{M}(\mathcal{S}_0) \subset \mathcal{S}_0$$

Remark 5.210 For large ν , \mathcal{M} is a contraction in a small neighborhood of the origin in $\| \cdot \|_{u, \nu}$.

Indeed, $\sup\{\|(\hat{\Lambda} - p)^{-1}\|_{\mathbb{C}^n \mapsto \mathbb{C}^n} : p \geq 1 + \epsilon\} = O(\epsilon^{-1})$ so that

$$\| \mathcal{M}(\delta_1) - \mathcal{M}(\delta_2) \|_{u, \nu} \leq \frac{\text{Const}}{\epsilon} \| \mathcal{N}(\delta_1) - \mathcal{N}(\delta_2) \|_{u, \nu} \tag{5.211}$$

The rest follows from (5.155), Proposition 5.145 and Proposition 5.140 applied to $\check{\mathbf{Y}}$.

□

The existence of a solution of (5.204) in $\mathcal{S}_0 \cap L_\nu^1([0, \infty))$ for large enough ν is now immediate.

Uniqueness in L^1_{loc} is tantamount to uniqueness in $L^1([1 + \epsilon, K]) = L^1_\nu([1 + \epsilon, K])$, for all $K - 1 - \epsilon \in \mathbb{R}^+$. Now, assuming \mathcal{M} had two fixed points in $L^1_\nu([1 + \epsilon, K])$, by Proposition 5.140, we can choose ν large enough so that these solutions have arbitrarily small norm, in contradiction with Remark 5.210.

(ii). For $p < 1$, $\mathbf{Y}_0^\pm(p) = \mathbf{Y}_0(p)$. For $p \in (1, 1 + \epsilon)$ the result follows from Lemma 5.170. Noting that (in view of the estimate (5.150)) $\mathcal{M}(\mathcal{Q}^\pm_{1+\epsilon, \infty}) \subset \mathcal{V}^\pm_{1+\epsilon, \infty}$, the rest of the proof follows from the Remark 5.210 and Lemma 5.170. □

5.10i General L^1_{loc} solution of the convolution equation

Proposition 5.212 *There is a one-parameter family of solutions of equation (5.89) in $L^1_{loc}[0, \infty)$, branching off at $p = 1$ and in a neighborhood of $p = 1$ all solutions are of the form (5.188), and (5.188'). The general solution of (5.89) is Laplace transformable for large ν and the Laplace transform is a solution of the original differential equation in the half-space $\text{Re}(x) > \nu$.*

Proof. Let \mathbf{Y} be any solution of (5.89). By Lemma 5.187 and Proposition 5.207, ν large implies that $\mathbf{Y} \in L^1_\nu([0, \infty))$ (thus $\mathcal{L}\mathbf{Y}$ exists), that $\|\mathbf{Y}\|_\nu$ is small and, in particular, that the sum defining \mathcal{N} in (5.87) is convergent in $L^1_\nu(\mathbb{R}^+)$. We have

$$\begin{aligned} \mathcal{L} \sum_{|\mathbf{l}| \geq 1} \mathbf{G}_1 * \mathbf{Y}^{*\mathbf{l}} + \sum_{|\mathbf{l}| \geq 2} \mathbf{g}_{0,1} \mathbf{Y}^{*\mathbf{l}} \\ = \sum_{|\mathbf{l}| \geq 1} (\mathcal{L}\mathbf{G}_1)(\mathcal{L}\mathbf{Y})^{\mathbf{l}} + \sum_{|\mathbf{l}| \geq 2} \mathbf{g}_{0,1} (\mathcal{L}\mathbf{Y})^{\mathbf{l}} = \sum_{|\mathbf{l}| \geq 1} \mathbf{g}_1 \mathbf{y}^{\mathbf{l}} = \mathbf{g} \end{aligned} \quad (5.213)$$

(and $\mathbf{g}(x, \mathbf{y}(x))$ is analytic for $\text{Re}(x) > \nu$). The rest is straightforward. □

Corollary 5.214 *There is precisely a one-parameter family of solutions of Eq. (5.51) having the asymptotic behavior described by $\tilde{\mathbf{y}}_0$ in the half-plane $\text{Re}(x) > 0$.*

Proof. Any solution with the properties stated in the corollary is inverse Laplace transformable and its inverse Laplace transform has to be one of the L^1_{loc} solutions of the convolution equation (5.89). The rest of the proof follows from Proposition 5.212. □

5.10j Equations and properties of \mathbf{Y}_k and summation of the transseries

Proposition 5.215 *Let \mathbf{Y} be any $L^1_{\text{loc}}(\mathbb{R}^+)$ solution of (5.89). For large ν and some $c > 0$ the coefficients \mathbf{d}_m in (5.92) are bounded by*

$$|\mathbf{d}_m(p)| \leq e^{c_0 p} c^{|\mathbf{m}|}$$

Note that $\mathcal{L}^{-1}(\mathbf{g}^{(\mathbf{m})}(x, \mathbf{y})/\mathbf{m}!)$ is the coefficient of $\mathbf{Z}^{*\mathbf{m}}$ in the expansion of $\mathcal{N}(\mathbf{Y} + \mathbf{Z})$ in convolution powers of Z (5.87):

$$\begin{aligned} \left(\left(\sum_{|\mathbf{l}| \geq 2} \mathbf{g}_{0,1} \cdot + \sum_{|\mathbf{l}| \geq 1} \mathbf{G}_{1*} \right) (\mathbf{Y} + \mathbf{Z})^{*\mathbf{l}} \right)_{\mathbf{Z}^{*\mathbf{m}}} &= \\ \left(\left(\sum_{|\mathbf{l}| \geq 2} \mathbf{g}_{0,1} \cdot + \sum_{|\mathbf{l}| \geq 1} \mathbf{G}_{1*} \right) \sum_{0 \leq \mathbf{k} \leq \mathbf{l}} \binom{\mathbf{l}}{\mathbf{k}} \mathbf{Z}^{*\mathbf{k}} \mathbf{Y}^{*(\mathbf{l}-\mathbf{k})} \right)_{\mathbf{Z}^{*\mathbf{m}}} &= \\ \left(\sum_{|\mathbf{l}| \geq 2} \mathbf{g}_{0,1} \cdot + \sum_{|\mathbf{l}| \geq 1} \mathbf{G}_{1*} \right) \sum_{\mathbf{l} \geq \mathbf{m}} \binom{\mathbf{l}}{\mathbf{m}} \mathbf{G}_{1*} * \mathbf{Y}^{*(\mathbf{l}-\mathbf{m})} & \quad (5.216) \end{aligned}$$

(\mathbf{m} is fixed) where $\mathbf{l} \geq \mathbf{m}$ means $l_i \geq m_i, i = 1, \dots, n$ and $\binom{\mathbf{l}}{\mathbf{k}} := \prod_{i=1}^n \binom{l_i}{k_i}$.

Let ϵ be small and ν large so that $\|\mathbf{Y}\|_\nu < \epsilon$. Then, for some constant K , we have (cf. (5.135))

$$\begin{aligned} \left| \left(\sum_{II} \mathbf{g}_{0,1} \cdot + \sum_I \mathbf{G}_{1*} \right) \binom{\mathbf{l}}{\mathbf{m}} \mathbf{G}_{1*} * \mathbf{Y}^{*(\mathbf{l}-\mathbf{m})} \right| &\leq \sum_I K e^{c_0 |p|} (c_0 \epsilon)^{|\mathbf{l}-\mathbf{m}|} \binom{\mathbf{l}}{\mathbf{m}} = \\ \epsilon^{-|\mathbf{m}|} K e^{c_0 |p|} \prod_{i=1}^n \sum_{l_i \geq m_i} \binom{l_i}{m_i} (c_0 \epsilon)^{l_i} &= K \frac{e^{c_0 |p|} c_0^{|\mathbf{m}|}}{(1 - \epsilon c_0)^{|\mathbf{m}|+n}} \leq e^{c_0 |p|} c^{|\mathbf{m}|} \quad (5.217) \end{aligned}$$

(where $I(II, \text{resp.}) \equiv \{|\mathbf{l}| \geq 1(2, \text{resp.}); \mathbf{l} \geq \mathbf{m}\}$) for large enough ν . □

For $k = 1, \mathbf{R}_1 = 0$ and equation (5.92) is (5.191) (with $p \leftrightarrow z$) but now on the whole line \mathbb{R}^+ . For small z the solution is given by (5.196) (note that $\mathbf{D}_1 = \mathbf{d}_{(1,0,\dots,0)}$ and so on) and depends on the free constant C (5.196). We choose a value for C (the values of \mathbf{Y}_1 on $[0, \epsilon]$ are then determined) and we write the equation of \mathbf{Y}_1 for $p \geq \epsilon$ as

$$\begin{aligned}
 &(\hat{\Lambda} - 1 - p)\mathbf{Y}_1(p) - \hat{A} \int_{\epsilon}^p \mathbf{Y}_1(s)ds - \sum_{j=1}^n \int_{\epsilon}^p (\mathbf{Y}_1)_j(s)\mathbf{D}_j(p - s)ds \\
 &= \mathbf{R}(p) := \int_0^{\epsilon} \mathbf{Y}_1(s)ds + \sum_{j=1}^n \int_0^{\epsilon} (\mathbf{Y}_1)_j(s)\mathbf{D}_j(p - s)ds \quad (5.218)
 \end{aligned}$$

(\mathbf{R} only depends on the values of $\mathbf{Y}_1(p)$ on $[0, \epsilon]$). We write

$$(1 + J_1)\mathbf{Y}_1 = \hat{Q}_1^{-1}\mathbf{R} \tag{5.219}$$

with $Q_1 = 1 - \hat{\Lambda} + p$. The operator J_1 is defined by $(J_1\mathbf{Y}_1)(p) := 0$ for $p < \epsilon$, while, for $p > \epsilon$ we write

$$(J_1\mathbf{Y}_1)(p) := Q_1^{-1} \left(\hat{B} \int_{\epsilon}^p \mathbf{Y}_1(s)ds - \sum_{j=1}^n \int_{\epsilon}^p (\mathbf{Y}_1)_j(s)\mathbf{D}_j(p - s)ds \right)$$

By Proposition 5.166, Proposition 5.140 and the Banach algebra properties, cf. §5.1, and noting that $\sup_{p>\epsilon} \|Q_1^{-1}\| = O(\epsilon^{-1})$, we find that $(1 + J_1)$ is invertible as an operator in L^1_{ν} since:

$$\|J_1\|_{L^1_{\nu} \rightarrow L^1_{\nu}} < \sup_{p>\epsilon} \|\hat{Q}_1^{-1}\| \left(\|\hat{B}\| \|1\|_{\nu} + n \max_{1 \leq j \leq n} \|\mathbf{D}_j\|_{\nu} \right) \rightarrow 0 \text{ as } \nu \rightarrow \infty \tag{5.220}$$

Given C , \mathbf{Y}_1 is therefore uniquely determined from (5.219) as an $L^1_{\nu}(\mathbb{R}^+)$ function.

The analytic structure of \mathbf{Y}_1 for small z is contained in (5.188) and (5.188'). As a result,

$$\mathcal{L}(\mathbf{Y}_1)(x) \sim C \sum_{k=0}^{\infty} \frac{\Gamma(k + \beta)}{x^{k+\beta}} \mathbf{a}_k \tag{5.221}$$

where $\sum_{k=0}^{\infty} \mathbf{a}_k z^k$ is the series of $\mathbf{a}(z)$ near $z = 0$.

Correspondingly, we write (5.92) as

$$(1 + J_k)\mathbf{Y}_k = \hat{Q}_k^{-1}\mathbf{R}_k \tag{5.222}$$

with $\hat{Q}_k := (-\hat{\Lambda} + p + k)$ and

$$(J_k\mathbf{h})(p) := \hat{Q}_k^{-1} \left(\hat{B} \int_0^p \mathbf{h}(s)ds - \sum_{j=1}^n \int_0^p h_j(s)\mathbf{D}_j(p - s)ds \right) \tag{5.223}$$

$$\|J_k\|_{L^1_\nu \rightarrow L^1_\nu} < \sup_{p \geq 0} \|\hat{Q}_k^{-1}\| \left(\|\hat{B}\| \|1\|_\nu + n \max_{1 \leq j \leq n} \|\mathbf{D}_j\|_\nu \right) \tag{5.224}$$

Since $\sup_{p \geq 0} \|\hat{Q}_k^{-1}\| \rightarrow 0$ as $k \rightarrow \infty$ we have

$$\sup_{k \geq 1} \{ \|J_k\|_{L^1_\nu \rightarrow L^1_\nu} \} \rightarrow 0 \text{ as } \nu \rightarrow \infty \tag{5.225}$$

Thus,

Proposition 5.226 *For large ν , $(1 + J_k), k \geq 1$ are simultaneously invertible in L^1_ν , (cf. 5.225). Given \mathbf{Y}_0 and C , $\mathbf{Y}_k, k \geq 1$ are uniquely determined and moreover, for $k \geq 2$, the following estimate holds*

$$\|\mathbf{Y}_k\|_\nu \leq \frac{\sup_{p \geq 0} \|\hat{Q}_k^{-1}\|}{1 - \sup_{k \geq 1} \|J_k\|_{L^1_\nu \rightarrow L^1_\nu}} \|\mathbf{R}_k\|_\nu := K \|\mathbf{R}_k\|_\nu \tag{5.227}$$

□

(Note: There is a *one-parameter* only freedom in \mathbf{Y}_k : a change in \mathbf{Y}_0 can be compensated for by a corresponding change in C .)

Because of the condition $\sum m = k$ in the definition of \mathbf{R}_k , we get, by an easy induction, the homogeneity relation with respect to the free constant C ,

$$\mathbf{Y}_k^{[C]} = C^k \mathbf{Y}_k^{[C=1]} =: C^k \mathbf{Y}_k \tag{5.228}$$

Proposition 5.229 *For any $\delta > 0$ there is a large enough ν , so that*

$$\|\mathbf{Y}_k\|_\nu < \delta^k, \quad k = 0, 1, \dots \tag{5.230}$$

Each \mathbf{Y}_k is Laplace transformable and $\mathbf{y}_k = \mathcal{L}(\mathbf{Y}_k)$ solve (5.90).

Proof

We first show inductively that the \mathbf{Y}_k are bounded. Choose r small enough and ν large so that $\|\mathbf{Y}_0\|_\nu < r$. Note that in the expression of \mathbf{R}_k , only \mathbf{Y}_i with $i < k$ appear. We show by induction that $\|\mathbf{Y}_k\|_\nu < r$ for all k . Using (5.227), (5.92) the explanation to (5.90) and Proposition 5.215 we get

$$\|\mathbf{Y}_k\|_\nu < K \|\mathbf{R}_k\|_\nu \leq \sum_{|l| > 1} c_0^{|l|} r^k \sum_{\Sigma m = k} 1 \leq r^k \left(\sum_{l > 1} \binom{l}{k} c_0^l \right)^n \leq (r(1+c_0)^n)^k < r \tag{5.231}$$

if r is small which completes this induction step. But now if we look again at (5.231) we see that in fact $\|\mathbf{Y}_k\|_\nu \leq (r(1+c_0)^n)^k$. Choosing r small enough, (and to that end, ν large enough) the first part of Proposition 5.229 follows. Laplace transformability as well as the fact that \mathbf{y}_k solve (5.90) follow

immediately from (5.230) (observe again that, given k , there are only finitely many terms in the sum in \mathbf{R}_k).

□

Therefore,

Remark 5.232 *The series*

$$\sum_{k=0}^{\infty} C^k(\mathbf{Y}_k \cdot \mathcal{H}) \circ \tau_k \tag{5.233}$$

is convergent in L^1_ν for large ν and thus the sum is Laplace transformable. By Proposition 5.230 we have

$$\mathcal{L} \sum_{k=0}^{\infty} C^k(\mathbf{Y}_k \mathcal{H}) \circ \tau_k = \sum_{k=0}^{\infty} C^k e^{-kx} \mathcal{L} \mathbf{Y}_k \tag{5.234}$$

is uniformly convergent for large x (together with its derivatives with respect to x). Thus (by construction) (5.234) is a solution of (5.51).

□

(Alternatively, we could have checked in a straightforward way that the series (5.233), truncated to order N is a solution of the convolution equation (5.89) on the interval $p \in [0, N)$ and in view of the $L^1_\nu(\mathbb{R}^+)$ (or even L^1_{loc}) convergence it has to be one of the general solutions of the convolution equation and therefore provide a solution to (5.51).)

Proof of Proposition 5.113, (ii)

We now show (5.115). This is done from the system (5.92) by induction on k . For $k = 0$ and $k = 1$ the result follows from Proposition 5.133 and Proposition 5.181. For the induction step we consider the operator J_k (5.223) on the space

$$\mathcal{Q}_k = \{ \mathbf{Q} : [0, \epsilon) \mapsto \mathbb{C} : \mathbf{Q}(z) = z^{k\beta-1} \mathbf{A}_k(z) \} \tag{5.235}$$

where \mathbf{A}_k extends as an analytic function in a neighborhood \mathbb{D}_ϵ of $z = 0$. Endowed with the norm

$$\| \mathbf{Q} \| = \sup_{z \in \mathbb{D}_\epsilon} | \mathbf{A}_k(z) |$$

\mathcal{Q}_k is a Banach space.

Remark 5.236 *For $k \in \mathbb{N}^+$ the operators J_k in (5.223) extend continuously to \mathcal{Q}_k and their norm is $O(\epsilon)$. The functions \mathbf{R}_k , $k \in \mathbb{N}^+$ (cf. (5.222), (5.92)), belong to \mathcal{Q}_k . Thus for $k \in \mathbb{N}^+$, $\mathbf{Y}_k \in \mathcal{Q}_k$.*

If A, B are analytic, then for $z < \epsilon$

$$\int_0^z ds s^{k\beta-1} A(s)B(z-s) = z^{k\beta} \int_0^1 dt t^r A(z t)B(z(1-t)) \tag{5.237}$$

is in \mathcal{Q}_k with norm $O(\epsilon)$ and the assertion about J_k follows easily. Therefore $\mathbf{Y}_k \in \mathcal{Q}_k$ if $\mathbf{R}_k \in \mathcal{Q}_k$. We prove both of these properties by induction and (by the homogeneity of \mathbf{R}_k and the fact that \mathbf{R}_k depends only on $\mathbf{Y}_m, m < k$) this amounts to checking that if $\mathbf{Y}_m \in \mathcal{Q}_m$ and $\mathbf{Y}_n \in \mathcal{Q}_n$, then

$$\mathbf{Y}_m * \mathbf{Y}_n \in \mathcal{Q}_{m+n}$$

as a result of the identity

$$\int_0^z ds s^r A(s)(z-s)^q B(z-s) = z^{r+q+1} \int_0^1 dt t^r (1-t)^q A(z t)B(z-zt)$$

□

It is now easy to see that $\mathcal{L}_\phi \mathcal{B}\tilde{\mathbf{y}}_k \sim \tilde{\mathbf{y}}_k$ (cf. [Theorem 5.120](#)). Indeed, note that in view of Remark 5.236 and Proposition 5.229, $\mathcal{L}(\mathbf{Y}_k)$ have asymptotic power series that can be differentiated for large x in the positive half-plane. Since $\mathcal{L}(\mathbf{Y}_k)$ are actual solutions of the system (5.90), their asymptotic series are formal solutions of (5.90) and by the uniqueness of the formal solution of (5.90) once C is given, the property follows.

In the next subsection, we prove that the general solution of the system (5.90) can be obtained by means of Borel transform of formal series and analytic continuation.

We define \mathbf{Y}^+ to be the function defined in Proposition 5.207, extended in $\mathcal{W} \cap \mathbb{C}^+$ by the unique solution of (5.89) \mathbf{Y}_0 provided by Proposition 5.133. (We define \mathbf{Y}^- correspondingly.)

By Proposition 5.207 (ii), \mathbf{Y}^\pm are solutions of (5.89) on $[0, \infty)$ (cf. (5.206)). By Lemma 5.187 any solution on $[0, \infty)$ can be obtained from, say, \mathbf{Y}^+ by choosing C and then solving uniquely (5.204) on $[1+\epsilon, \infty)$ (Proposition 5.207). We now show that the solutions of (5.219), (5.222) are continuous boundary values of functions analytic in a region bounded by \mathbb{R}^+ .

Remark 5.238 *The function $\mathbf{D}(s)$ defined in (5.169) by substituting $\mathbf{H} = \mathbf{Y}^\pm$, is in $\mathcal{Q}_{0,\infty}^\pm$ (cf. (5.206)).*

By Proposition 5.207, (ii) it is easy to check that if \mathbf{H} is any function in $\mathcal{Q}_{0,A}^+$, then $\mathbf{Y}^+ * \mathbf{Q} \in \mathcal{T}_{0,A}^+$. Thus, with $\mathbf{H} = \mathbf{Y}^+$, all the terms in the infinite sum in (5.169) are in $\mathcal{Q}_{0,A}^+$. For fixed $A > 0$, taking ν large enough, the norm ρ_ν of \mathbf{Y}^+ in L_ν^1 can be made arbitrarily small uniformly in all rays in $S_{0,A}^+$

(5.206) (Proposition 5.207). Then by Corollary 5.141 and Proposition 5.207 (ii), the uniform norm of each term in the series

$$D_j = \sum_{|I| \geq 1} l_j \mathbf{G}_1 * (\mathbf{Y}^\pm)^{* \bar{I}^j} + \sum_{|I| \geq 2} l_j \mathbf{g}_{0,1} (\mathbf{Y}^\pm)^{* \bar{I}^j}; \bar{I}^j := (l_1, l_2, \dots, (l_j - 1), \dots, l_n) \tag{5.239}$$

can be estimated by $Const \rho_\nu^{|I|-1} c^{|I|}$ and thus the series converges uniformly in $\mathcal{Q}^+_{0,\infty}$, for large ν . □

Lemma 5.240 (i) *The system (5.92) with $\mathbf{Y}_0 = \mathbf{Y}^+$ (or \mathbf{Y}^-) and given C (say $C = 1$) has a unique solution in $L^1_{loc}(\mathbb{R}^+)$, namely \mathbf{Y}^+_k , (\mathbf{Y}^-_k , resp.), $k \in \mathbb{N}^+$. Furthermore, for large ν and all k , $\mathbf{Y}^+_k \in \mathcal{Q}^+_{0,\infty}$ ($\mathbf{Y}^-_k \in \mathcal{Q}^-_{0,\infty}$) (cf. (5.206)).*

(ii) *The general solution of the equation (5.89) in $L^1_{loc}(\mathbb{R}^+)$ can be written in either of the forms:*

$$\mathbf{Y}^+ + \sum_{k=1}^\infty C^k (\mathbf{Y}^+_k \cdot \mathcal{H}) \circ \tau_{-k} \quad \text{or} \quad \mathbf{Y}^- + \sum_{k=1}^\infty C^k (\mathbf{Y}^-_k \cdot \mathcal{H}) \circ \tau_{-k} \tag{5.241}$$

PROOF

(i) The first part follows from the same arguments as Proposition 5.226. For the last statement it is easy to see (cf. (5.237)) that $J_k \mathcal{Q}^+_{0,\infty} \subset \mathcal{Q}^+_{0,\infty}$ the inequalities (5.224), (5.225) hold for $\|\cdot\|_{\mathcal{Q}_{0,A} \rightarrow \mathcal{Q}_{0,A}}$ (A arbitrary) replacing $\|\cdot\|_{L^1_\nu \rightarrow L^1_\nu}$ (cf. §5.1).

(ii) We already know that \mathbf{Y}^+ solves (5.92) for $k = 0$. For $k > 0$ by (i) $C^k \mathbf{Y}^+_k \in \mathcal{Q}_{0,\infty}$ and so, by continuity, the boundary values of \mathbf{Y}^+_k on \mathbb{R}^+ solve the system (5.92) on \mathbb{R}^+ in L^1_{loc} . The rest of (ii) follows from Lemma 5.187, Proposition 5.207 and the arbitrariness of C in (5.241) (cf. also (5.196)). □

5.10k Analytic structure, resurgence, averaging

Having the general structure of the solutions of (5.89) given in Proposition 5.124 and in Lemma 5.240, we can obtain various analytic identities. The function $\mathbf{Y}^\pm_0 := \mathbf{Y}^\pm$ has been defined in the previous section.

Proposition 5.242 *For $m \geq 0$,*

$$\mathbf{Y}^-_m = \mathbf{Y}^+_m + \sum_{k=1}^\infty \binom{m+k}{m} S^k_\beta (\mathbf{Y}^+_{m+k} \cdot \mathcal{H}) \circ \tau_{-k} \tag{5.243}$$

Proof.

$\mathbf{Y}^-_0(p)$ is a particular solution of (5.89). It follows from Lemma 5.240 that the following identity holds on \mathbb{R}^+ :

$$\mathbf{Y}_0^- = \mathbf{Y}_0^+ + \sum_{k=1}^{\infty} S_{\beta}^k(\mathbf{Y}_k^+ \cdot \mathcal{H}) \circ \tau_{-k} \tag{5.244}$$

since, by (5.127) and (5.114), (5.244) holds for $p \in (0, 2)$.

By Lemma 5.240 for any C_+ there is a C_- so that

$$\mathbf{Y}_0^+ + \sum_{k=1}^{\infty} C_+^k(\mathbf{Y}_k^+ \cdot \mathcal{H}) \circ \tau_{-k} = \mathbf{Y}_0^- + \sum_{k=1}^{\infty} C_-^k(\mathbf{Y}_k^- \cdot \mathcal{H}) \circ \tau_{-k} \tag{5.245}$$

To find the relation between C_+ and C_- we take $p \in (1, 2)$; we get, comparing with (5.244):

$$\mathbf{Y}_0^+(p) + C_+ \mathbf{Y}_1(p-1) = \mathbf{Y}_0^-(p) + C_- \mathbf{Y}_1(p-1) \Rightarrow C_+ = C_- + S_{\beta} \tag{5.246}$$

whence, for any $C \in \mathbb{C}$,

$$\mathbf{Y}_0^+ + \sum_{k=1}^{\infty} (C + S_{\beta})^k(\mathbf{Y}_k^+ \cdot \mathcal{H}) \circ \tau_{-k} = \mathbf{Y}_0^- + \sum_{k=1}^{\infty} C^k(\mathbf{Y}_k^- \cdot \mathcal{H}) \circ \tau_{-k} \tag{5.247}$$

Differentiating m times with respect to C and taking $C = 0$ we get

$$\sum_{k=m}^{\infty} \frac{k!}{(k-m)!} S_{\beta}^{k-m}(\mathbf{Y}_k^+ \cdot \mathcal{H}) \circ \tau_{-k} = m!(\mathbf{Y}_m^- \cdot \mathcal{H}) \circ \tau_{-m}$$

from which we obtain (5.243) by rearranging the terms and applying τ_m . □

Proposition 5.248 *The functions \mathbf{Y}_k , $k \geq 0$, are analytic in \mathcal{R}_1 .*

PROOF

Starting with (5.244), if we take $p \in (1, 2)$ and obtain:

$$\mathbf{Y}_0^-(p) = \mathbf{Y}_0^+(p) + S_{\beta} \mathbf{Y}_1(p-1) \tag{5.249}$$

By Proposition 5.207 and Lemma 5.240 the lhs of (5.249) is analytic in a lower half-plane neighborhood of $(\varepsilon, 1 - \varepsilon)$, ($\forall \varepsilon \in (0, 1)$) and continuous in the closure of such a neighborhood. The right side is analytic in an upper half-plane neighborhood of $(\varepsilon, 1 - \varepsilon)$, ($\forall \varepsilon \in (0, 1)$) and continuous in the closure of such a neighborhood. Thus, $\mathbf{Y}_0^-(p)$ can be analytically continued along a path crossing the interval $(1, 2)$ from below, i.e., \mathbf{Y}_0^{-+} exists and is analytic.

Now, in (5.244), let $p \in (2, 3)$. Then,

$$S_\beta^2 \mathbf{Y}_2(p-2) = \mathbf{Y}_0(p)^- - \mathbf{Y}(p)^+ - S_\beta \mathbf{Y}_1(p-1)^+ = \mathbf{Y}_0(p)^- - \mathbf{Y}_0(p)^+ - \mathbf{Y}_0(p)^{-+} + \mathbf{Y}_0(p)^+ = \mathbf{Y}_0(p)^- - \mathbf{Y}_0(p)^{-+} \quad (5.250)$$

and, in general, taking $p \in (k, k+1)$ we get

$$S_\beta^k \mathbf{Y}_k(p-k) = \mathbf{Y}_0(p)^- - \mathbf{Y}_0(p)^{-k-1+} \quad (5.251)$$

Using (5.251) inductively, the same arguments that we used for $p \in (0, 1)$ show that $\mathbf{Y}_0^{-k}(p)$ can be continued analytically in the upper half-plane. Thus, we have

Remark 5.252 *The function \mathbf{Y}_0 is analytic in \mathcal{R}_1 . In fact, for $p \in (j, j+1)$, $j \in \mathbb{N}^+$,*

$$\mathbf{Y}_0^{-j+}(p) = \mathbf{Y}_0^+(p) + \sum_{k=1}^j S_\beta^k \mathbf{Y}_k^+(p-k) \mathcal{H}(p-k) \quad (5.253)$$

The relation (5.253) follows from (5.251) and (5.244). □

Note: Unlike (5.244), the sum in (5.253) contains finitely many terms. For instance we have:

$$\mathbf{Y}_0^{-+}(p) = \mathbf{Y}_0^+(p) + \mathcal{H}(p-1) \mathbf{Y}_1^+(p-1) \quad (\forall p \in \mathbb{R}^+) \quad (5.254)$$

Analyticity of \mathbf{Y}_m , $m \geq 1$ is shown inductively on m , using (5.243) and following exactly the same course of proof as for $k = 0$. □

Remark 5.255 *If $S_\beta = 0$, then \mathbf{Y}_k are analytic in $\mathcal{W}_1 \cup \mathbb{N}$.*

Indeed, this follows from (5.244) (5.243) and Lemma 5.240 (i). □

On the other hand, if $S_\beta \neq 0$, then all \mathbf{Y}_k are analytic continuations of the Borel transform of \mathbf{Y}_0 (cf. (5.250))—an instance of resurgence . Moreover, we can now calculate \mathbf{Y}_0^{ba} . By definition, (see the discussion before [Remark 5.184](#)) on the interval $(0, 2)$,

$$\mathbf{Y}_0^{ba} = \frac{1}{2}(\mathbf{Y}_0^+ + \mathbf{Y}_0^-) = \mathbf{Y}_0^+ + \frac{1}{2} S_\beta (\mathbf{Y}_1 \mathcal{H}) \circ \tau_{-1} \quad (5.256)$$

Now we are looking for a solution of (5.89) which satisfies the condition (5.256). By comparing with Lemma 5.240, which gives the general form of the solutions of (5.89), we get, now on the whole positive axis,

$$\mathbf{Y}_0^{ba} = \mathbf{Y}_0^+ + \sum_{k=1}^{\infty} \frac{1}{2^k} S_{\beta}^k(\mathbf{Y}_k^+ \mathcal{H}) \circ \tau_{-k} \quad (\text{on } \mathbb{R}^+) \tag{5.257}$$

which we can rewrite using (5.251):

$$\mathbf{Y}_0^{ba} = \mathbf{Y}_0^+ + \sum_{k=1}^{\infty} \frac{1}{2^k} \left(\mathbf{Y}_0^{-k} - \mathbf{Y}_0^{-k-1+} \right) (\mathcal{H} \circ \tau_{-k}) \tag{5.258}$$

Proposition 5.259 *Let $\psi_1(p), \psi_2(p)$ be analytic in \mathcal{R}_1 , and such that for any path $\gamma = t \mapsto t \exp(i\phi(t))$ in \mathcal{R}_1 ,*

$$|\psi_{1,2}(\gamma(t))| < f_{\gamma}(t) \in L_{loc}^1(\mathbb{R}^+) \tag{5.260}$$

Assume further that for some large enough ν, M and any path γ in \mathcal{R}_1 we have

$$\int_{\gamma} |\psi_{1,2}|(s) e^{-\nu|s|} |ds| < M \tag{5.261}$$

Then the analytic continuation $AC_{\gamma}(\psi_1 * \psi_2)$ along a path γ in \mathcal{R}_1 of their convolution product $\psi_1 * \psi_2$ (defined for small p by (2.21)) exists, is locally integrable and satisfies (5.260) and, for the same ν and some γ -independent $M' > 0$,

$$\int_{\gamma} |\psi_1 * \psi_2|(s) e^{-\nu|s|} |ds| < M' \tag{5.262}$$

Proof. Since

$$2\psi_1 * \psi_2 = (\psi_1 + \psi_2) * (\psi_1 + \psi_2) - \psi_1 * \psi_1 - \psi_2 * \psi_2 \tag{5.263}$$

it is enough to take $\psi_1 = \psi_2 = \psi$. For $p \in \mathbb{R}^+ \setminus \mathbb{N}$ we write:

$$\psi^- = \psi^+ + \sum_{k=1}^{\infty} (\mathcal{H} \cdot \psi_k^+) \circ \tau_{-k} \tag{5.264}$$

The functions ψ_k are defined inductively (the superscripts “+,-” mean, as before, the analytic continuations in \mathcal{R}_1 going below (above) the real axis). In the same way (5.251) was obtained we get by induction:

$$\psi_k = (\psi^- - \psi^{-k-1+}) \circ \tau_k \tag{5.265}$$

where the equality holds on $\mathbb{R}^+ \setminus \mathbb{N}$ and +, - mean the upper and lower continuations. For any p only finitely many terms in the sum in (5.264) are nonzero. The sum is also convergent in $\|\cdot\|_{\nu}$ (by dominated convergence; note that, by assumption, the functions $\psi^{-\dots\pm}$ belong to the same L_{ν}^1).

If $t \mapsto \gamma(t)$ in \mathcal{R}_1 , is a straight line, other than \mathbb{R}^+ , then:

$$AC_\gamma((\psi * \psi)) = AC_\gamma(\psi) *_\gamma AC_\gamma(\psi) \text{ if } \arg(\gamma(t)) = \text{const} \neq 0 \quad (5.266)$$

(Since ψ is analytic along such a line). The notation $*_\gamma$ means (2.21) with $p = \gamma(t)$.

Note though that, suggestive as it might be, (5.266) is *incorrect* if the condition stated there is not satisfied and γ is a path that crosses the real line (see §5.11a)!

From (5.266) and (5.264), we get

$$\begin{aligned} (\psi * \psi)^- &= \psi^- * \psi^- = \psi^+ * \psi^+ + \sum_{k=1}^\infty \left(\mathcal{H} \sum_{m=0}^k \psi_m^+ * \psi_{k-m}^+ \right) \circ \tau_{-k} = \\ &(\psi * \psi)^+ + \sum_{k=1}^\infty \left(\mathcal{H} \sum_{m=0}^k (\psi_m * \psi_{k-m})^+ \right) \circ \tau_{-k} \end{aligned} \quad (5.267)$$

and now the analyticity of $\psi * \psi$ in \mathcal{R}_1 follows: on the interval $p \in (m, m + 1)$ we have from (5.265)

$$(\psi * \psi)^{-j}(p) = (\psi * \psi)^-(p) = (\psi^{*2})^+(p) + \sum_{k=1}^j \sum_{m=0}^k (\psi_m * \psi_{k-m})^+(p - k) \quad (5.268)$$

Again, formula (5.268) is useful for analytically continuing $(\psi * \psi)^{-j}$ along a path as the one depicted in Fig. 5.1. By dominated convergence, $(\psi * \psi)^\pm \in \mathcal{V}_{(0,\infty)}^\pm$, (5.206). By (5.265), ψ_m are analytic in $\mathcal{R}_1^+ := \mathcal{R}_1 \cap \{p : \text{Im}(p) > 0\}$ and thus by (5.266) the right side . of (5.268) can be continued analytically in \mathcal{R}_1^+ . The same is then true for $(\psi * \psi)^-$. The function $(\psi * \psi)$ can be extended analytically along paths that cross the real line from below. Likewise, $(\psi * \psi)^+$ can be continued analytically in the lower half-plane so that $(\psi * \psi)$ is analytic in \mathcal{R}_1 .

Combining (5.268), (5.266) and (5.263) we get a similar formula for the analytic continuation of the convolution product of two functions, f, g satisfying the assumptions of Proposition 5.259

$$(f * g)^{-j+} = f^+ * g^+ + \sum_{k=1}^j \left(\mathcal{H} \sum_{m=0}^k f_m^+ * g_{k-m}^+ \right) \circ \tau_{-k} \quad (5.269)$$

Note that (5.269) corresponds to (5.264) and in those notations we have:

$$(f * g)_k = \sum_{m=0}^k f_m * g_{k-m} \quad (5.270)$$

Integrability as well as (5.262) follow from (5.265), (5.268) and Remark 5.140. □

By (5.118) and (5.265),

$$\bar{\psi}^{ba} = \psi^+ + \sum_{k=1}^{\infty} \frac{1}{2^k} (\psi_k^+ \mathcal{H}) \circ \tau_{-k}$$

so that

$$\begin{aligned} \psi^{ba} * \psi^{ba} &= \left(\psi^+ + \sum_{k=1}^{\infty} \frac{1}{2^k} (\mathcal{H} \circ \tau_{-k}) (\psi_k^+ \circ \tau_{-k}) \right)^{*2} = \\ &\psi^+ * \psi^+ + \sum_{k=1}^{\infty} \frac{1}{2^k} \mathcal{H} \circ \tau_{-k} \sum_{m=0}^k (\psi_m^+ \circ \tau_m) * (\psi_{k-m}^+ \circ \tau_{k-m}) \circ \tau_{-k} = \\ &\psi^+ * \psi^+ + \sum_{k=1}^{\infty} \frac{1}{2^k} \mathcal{H} \circ \tau_{-k} \sum_{m=0}^k (\psi_m * \psi_{k-m})^+ \circ \tau_{-k} = (\psi^{*2})^{ba} \end{aligned} \tag{5.271}$$

To finish the proof of Theorem 5.120, note that on any finite interval the sum in (5.118) has only a finite number of terms and by (5.271) balanced averaging commutes with any finite sum of the type

$$\sum_{k_1, \dots, k_n} c_{k_1, \dots, k_n} f_{k_1} * \dots * f_{k_n} \tag{5.272}$$

and then, by continuity, with any sum of the form (5.272), with a finite or infinite number of terms, provided it converges in L^1_{loc} . Averaging thus commutes with all the operations involved in the equations (5.222). By uniqueness therefore, if $\mathbf{Y}_0 = \mathbf{Y}^{ba}$ then $\mathbf{Y}_k = \mathbf{Y}_k^{ba}$ for all k . Preservation of reality is immediate since (5.89), (5.92) are real if (5.51) is real, therefore \mathbf{Y}_0^{ba} is real-valued on $\mathbb{R}^+ \setminus \mathbb{N}$ (since it is real-valued on $[0, 1) \cup (1, 2)$) and so are, inductively, all \mathbf{Y}_k .

5.11 Appendix

5.11a $AC(f * g)$ versus $AC(f) * AC(g)$

Typically, the analytic continuation along curve in \mathcal{W}_1 which is not homotopic to a straight line does not commute with convolution.

Remark 5.273 Let ψ be a function satisfying the conditions stated in Proposition 5.259 and assume that $p = 1$ is a branch point of ψ . Then,

$$(\psi * \psi)^{-+} \neq \psi^{-+} * \psi^{-+} \tag{5.274}$$

Proof

Indeed, by (5.269) and (5.265)

$$\begin{aligned} (\psi * \psi)^{-+} &= \psi^+ * \psi^+ + 2[(\psi^+ * \psi_1^+) \mathcal{H}] \circ \tau_{-1} \neq \psi^{-+} * \psi^{-+} = \\ [\psi^+ + (\mathcal{H}\psi_1^+) \circ \tau_{-1}]^{*2} &= \psi^+ * \psi^+ + 2[(\psi^+ * \psi_1^+) \mathcal{H}] \circ \tau_{-1} + [\mathcal{H}(\psi_1^+ * \psi_1^+)] \circ \tau_{-2} \end{aligned} \tag{5.275}$$

since in view of (5.265), in our assumptions, $\psi_1 \neq 0$ and thus $\psi_1 * \psi_1 \neq 0$. □

There is also the following intuitive reasoning leading to the same conclusion. For a generic system of the form (5.51), $p = 1$ is a branch point of \mathbf{Y}_0 and so $\mathbf{Y}_0^- \neq \mathbf{Y}_0^{-+}$. On the other hand, if AC_{-+} commuted with convolution, then $\mathcal{L}(\mathbf{Y}_0^{-+})$ would provide a solution of (5.51). By Lemma 5.240, $\mathcal{L}(\mathbf{Y}_0^-)$ is a different solution (since $\mathbf{Y}_0^- \neq \mathbf{Y}_0^{-+}$). As \mathbf{Y}_0^- and \mathbf{Y}_0^{-+} coincide up to $p = 2$ we have $\mathcal{L}(\mathbf{Y}_0^{-+}) - \mathcal{L}(\mathbf{Y}_0^-) = e^{-2x(1+o(1))}$ as $x \rightarrow +\infty$. By Theorem 5.120, however, no two solutions of (5.51) can differ by less than $e^{-x(1+o(1))}$ without actually being equal (also, heuristically, this can be checked using formal perturbation theory), contradiction.

5.11b Derivation of the equations for the transseries for general ODEs

Consider first the scalar equation

$$y' = f_0(x) - \lambda y - x^{-1}By + g(x, y) = -y + x^{-1}By + \sum_{k=1}^{\infty} g_k(x)y^k \tag{5.276}$$

For $x \rightarrow +\infty$ we take

$$y = \sum_{k=0}^{\infty} y_k e^{-kx} \tag{5.277}$$

where y_k can be formal series $x^{-s_k} \sum_{n=0}^{\infty} a_{kn} x^{-n}$, with $a_{k,0} \neq 0$, or actual functions with the condition that (5.277) converges uniformly. Let y_0 be the first term in (5.277) and $\delta = y - y_0$. We have

$$\begin{aligned}
 y^k - y_0^k - ky_0^{k-1}\delta &= \sum_{j=2}^k \binom{k}{j} y_0^{k-j} \delta^j = \sum_{j=2}^k \binom{k}{j} y_0^{k-j} \sum_{i_1, \dots, i_j=1}^{\infty} \prod_{s=1}^j (y_{i_s} e^{-i_s x}) \\
 &= \sum_{m=1}^{\infty} e^{-mx} \sum_{j=2}^k \binom{k}{j} y_0^{k-j} \sum_{(i_s)}^{(m;j)} \prod_{s=1}^j y_{i_s} \quad (5.278)
 \end{aligned}$$

where $\sum_{(i_s)}^{(m;j)}$ means the sum over all positive integers i_1, i_2, \dots, i_j satisfying $i_1 + i_2 + \dots + i_j = m$. Let $d_1 = \sum_{k \geq 1} kg_k y_0^{k-1}$. Introducing $y = y_0 + \delta$ in (5.276) and equating the coefficients of e^{-lx} we get, by separating the terms containing y_l for $l \geq 1$ and interchanging the j, k orders of summation,

$$\begin{aligned}
 y'_l + (\lambda(1-l) + x^{-1}B - d_1(x))y_l &= \sum_{j=2}^{\infty} \sum_{(i_s)}^{(l;j)} \prod_{s=1}^j y_{i_s} \sum_{k \geq \{2, j\}} \binom{k}{j} g_k y_0^{k-j} \\
 &= \sum_{j=2}^l \sum_{(i_s)}^{(l;j)} \prod_{s=1}^j y_{i_s} \sum_{k \geq \{2, j\}} \binom{k}{j} g_k y_0^{k-j} =: \sum_{j=2}^l d_j(x) \sum_{(i_s)}^{(l;j)} \prod_{s=1}^j y_{i_s} \quad (5.279)
 \end{aligned}$$

where for the middle equality we note that the infinite sum terminates because $i_s \geq 1$ and $\sum_{s=1}^j i_s = l$.

For a vectorial equation like (5.51) we first write

$$\mathbf{y}' = \mathbf{f}_0(x) - \hat{\Lambda} \mathbf{y} - x^{-1} \hat{B} \mathbf{y} + \sum_{\mathbf{k} > 0} \mathbf{g}_{\mathbf{k}}(x) \mathbf{y}^{\mathbf{k}} \quad (5.280)$$

with $\mathbf{y}^{\mathbf{k}} := \prod_{i=1}^{n_1} (y_i)^{k_i}$. As with (5.279), we introduce the transseries (5.111) in (5.280) and equate the coefficients of $\exp(-\mathbf{k} \cdot \boldsymbol{\lambda} x)$. Let $\mathbf{v}_{\mathbf{k}} = x^{-\mathbf{k} \cdot \mathbf{m}} \mathbf{y}_{\mathbf{k}}$ and

$$\mathbf{d}_{\mathbf{j}}(x) = \sum_{\mathbf{l} \geq \mathbf{j}} \binom{\mathbf{l}}{\mathbf{j}} \mathbf{g}_{\mathbf{l}}(x) \mathbf{v}_0^{\mathbf{l}-\mathbf{j}} \quad (5.281)$$

Noting that, by assumption, $\mathbf{k} \cdot \boldsymbol{\lambda} = \mathbf{k}' \cdot \boldsymbol{\lambda} \Leftrightarrow \mathbf{k} = \mathbf{k}'$ we obtain, for $\mathbf{k} \in \mathbb{N}^{n_1}$, $\mathbf{k} > 0$

$$\begin{aligned}
 \mathbf{v}'_{\mathbf{k}} + \left(\hat{\Lambda} - \mathbf{k} \cdot \boldsymbol{\lambda} \hat{\Gamma} + x^{-1} \hat{B} \right) \mathbf{v}_{\mathbf{k}} + \sum_{|\mathbf{j}|=1} \mathbf{d}_{\mathbf{j}}(x) (\mathbf{v}_{\mathbf{k}})^{\mathbf{j}} \\
 = \sum_{\substack{\mathbf{j} \leq \mathbf{k} \\ |\mathbf{j}| \geq 2}} \mathbf{d}_{\mathbf{j}}(x) \sum_{(\mathbf{i}_{m,p} : \mathbf{k})} \prod_{m=1}^n \prod_{p=1}^{j_m} (\mathbf{v}_{\mathbf{i}_{m,p}})_{m} = \mathbf{t}_{\mathbf{k}}(\mathbf{v}) \quad (5.282)
 \end{aligned}$$

where $\binom{l}{j} = \prod_{j=1}^n \binom{l_i}{j_i}$, $(\mathbf{v})_m$ means the component m of \mathbf{v} , and $\sum_{(\mathbf{i}_{mp}; \mathbf{k})}$ stands for the sum over all vectors $\mathbf{i}_{mp} \in \mathbb{N}^n$, with $p \leq j_m, m \leq n$, so that $\mathbf{i}_{mp} \succ 0$ and $\sum_{m=1}^n \sum_{p=1}^{j_m} \mathbf{i}_{mp} = \mathbf{k}$. We use the convention $\prod_{\emptyset} = 1, \sum_{\emptyset} = 0$. With $m_i = 1 - [\text{Re } \beta_i]$ we obtain for $\mathbf{y}_{\mathbf{k}}$

$$\mathbf{y}'_{\mathbf{k}} + \left(\hat{\Lambda} - \mathbf{k} \cdot \boldsymbol{\lambda} \hat{\Lambda} + x^{-1}(\hat{B} + \mathbf{k} \cdot \mathbf{m}) \right) \mathbf{y}_{\mathbf{k}} + \sum_{|\mathbf{j}|=1} \mathbf{d}_{\mathbf{j}}(x)(\mathbf{y}_{\mathbf{k}})^{\mathbf{j}} = \mathbf{t}_{\mathbf{k}}(\mathbf{y}) \quad (5.283)$$

There are clearly finitely many terms in $\mathbf{t}_{\mathbf{k}}(\mathbf{y})$. To find a (not too unrealistic) upper bound for this number of terms, we compare with $\sum_{(\mathbf{i}_{mp})'}$ which stands for the same as $\sum_{(\mathbf{i}_{mp})}$ except with $\mathbf{i} \geq 0$ instead of $\mathbf{i} \succ 0$. Noting that $\binom{k+s-1}{s-1} = \sum_{a_1+\dots+a_s=k} 1$ is the number of ways k can be written as a sum of s integers, we have

$$\sum_{(\mathbf{i}_{mp})} 1 \leq \sum_{(\mathbf{i}_{mp})'} 1 = \prod_{l=1}^{n_1} \sum_{(\mathbf{i}_{mp})_l} 1 = \prod_{l=1}^{n_1} \binom{k_l + |\mathbf{j}| - 1}{|\mathbf{j}| - 1} \leq \binom{|\mathbf{k}| + |\mathbf{j}| - 1}{|\mathbf{j}| - 1}^{n_1} \quad (5.284)$$

Remark 5.285 Equation (5.282) can be written in the form (5.91).

Proof. The fact that only predecessors of \mathbf{k} are involved in $\mathbf{t}(\mathbf{y}_0, \cdot)$ and the homogeneity property of $\mathbf{t}(\mathbf{y}_0, \cdot)$ follow immediately by combining the conditions $\sum \mathbf{i}_{mp} = \mathbf{k}$ and $\mathbf{i}_{mp} \succ 0$. □

The formal inverse Laplace transform of (5.283) is then

$$\left(-p + \hat{\Lambda} - \mathbf{k} \cdot \boldsymbol{\lambda} \right) \mathbf{Y}_{\mathbf{k}} + \left(\hat{B} + \mathbf{k} \cdot \mathbf{m} \right) \mathcal{P} \mathbf{Y}_{\mathbf{k}} + \sum_{|\mathbf{j}|=1} \mathbf{D}_{\mathbf{j}} * (\mathbf{Y}_{\mathbf{k}})^{\mathbf{j}} = \mathbf{T}_{\mathbf{k}}(\mathbf{Y}) \quad (5.286)$$

with

$$\mathbf{T}_{\mathbf{k}}(\mathbf{Y}) = \mathbf{T}(\mathbf{Y}_0, \{\mathbf{Y}_{\mathbf{k}'}\}_{0 \prec \mathbf{k}' \prec \mathbf{k}}) = \sum_{\mathbf{j} \leq \mathbf{k}; |\mathbf{j}| > 1} \mathbf{D}_{\mathbf{j}}(p) * \sum_{(\mathbf{i}_{mp}; \mathbf{k})} \prod_{m=1}^{n_1} \prod_{p=1}^{j_m} (\mathbf{Y}_{\mathbf{i}_{mp}})_{\mathbf{m}} \quad (5.287)$$

and

$$\mathbf{D}_{\mathbf{j}} = \sum_{\mathbf{l} \geq \mathbf{m}} \binom{\mathbf{l}}{\mathbf{m}} \mathbf{G}_{\mathbf{l}} * \mathbf{Y}_0^{*(\mathbf{l}-\mathbf{m})} + \sum_{\mathbf{l} \geq \mathbf{m}; |\mathbf{l}| \geq 2} \binom{\mathbf{l}}{\mathbf{m}} \mathbf{g}_{0,1} \mathbf{Y}_0^{*(\mathbf{l}-\mathbf{m})} \quad (5.288)$$

5.11c Appendix: Formal diagonalization

Consider again the equation

$$\mathbf{y}' = \mathbf{f}_0(x) - \hat{\Lambda} \mathbf{y} + \frac{1}{x} \hat{A} \mathbf{y} + \mathbf{g}(x, \mathbf{y}) \quad (5.289)$$

If $\hat{\Lambda}$ is diagonalizable, then it can be easily diagonalized in (5.289) by the substitution $\mathbf{y} = \hat{C}\mathbf{y}^{[1]}$, where $= \hat{C}^{-1}\hat{\Lambda}\hat{C}$ is diagonal.

So we can assume that $\hat{\Lambda}$ is already diagonal. Now, a transformation of the form $\mathbf{y} = (I + x^{-1}\hat{V})\mathbf{y}^{[1]}$ brings (5.289), up to terms of order \mathbf{y}/x^2 , to an equation of the type

$$\mathbf{y}' = \mathbf{f}_0(x) - \hat{\Lambda}\mathbf{y} + \frac{1}{x} \left(\hat{A} + \hat{V}\hat{\Lambda} - \hat{V}\hat{\Lambda} \right) \mathbf{y} + \mathbf{g}(x, \mathbf{y}) \tag{5.290}$$

Now we regard the map

$$\hat{\Lambda}\hat{V} := \hat{V}\hat{\Lambda} - \hat{V}\hat{\Lambda}$$

as a linear map on the space of matrices \hat{V} , or, which is the same, on \mathbb{C}^{2n} . The equation

$$\hat{\Lambda}\hat{V} = \hat{X} \tag{5.291}$$

has a unique solution *iff* \hat{X} is not in the kernel of $\hat{\Lambda}$, which by definition, consists in all matrices such that $\hat{\Lambda}\hat{Y} = 0$, or, in other words, all matrices which commute with $\hat{\Lambda}$. Since the eigenvalues of $\hat{\Lambda}$ are distinct, it is easy to check that $\hat{\Lambda}\hat{Y} = 0$ implies \hat{Y} is diagonal. So, we can change the *off-diagonal* elements of \hat{A} at will, in particular we can choose them to be zero. By further transformations $\mathbf{y} = (I + x^{-j}\hat{V})\mathbf{y}^{[1]}$, $j = 2\dots m$, we can diagonalize the coefficients of $x^{-2}\mathbf{y}, \dots, x^{-m}\mathbf{y}$.

So, we can assume all coefficients of $x^{-j}\mathbf{y}$ up to any fixed m are diagonal. To show that we can actually assume the coefficients of $x^{-j}\mathbf{y}$, $j = 2\dots m$, to be zero it is then enough to show that this is possible for a scalar equation

$$y' = f_0(x) - \Lambda y + \frac{1}{x}Ay + (A_2x^{-2} + \dots + A_mx^{-m})y + \mathbf{g}(x, y) \tag{5.292}$$

As usual, by subtracting terms, we can assume $f_0(x) = O(x^{-M})$ for any choice of M , so for the purpose of this argument, we can see that we can safely assume f_0 is absent.

$$y' = -\Lambda y + \frac{1}{x}Ay + (A_2x^{-2} + \dots + A_mx^{-m})y + \mathbf{g}(x, y) \tag{5.293}$$

Now, taking $y = (1 + c_1/x + c_2/x^2 + \dots + c_m/x^m)y^{[1]}$ where for suitable c_i (check!).

***5.12 Appendix: The C^* -algebra of staircase distributions, $\mathcal{D}'_{m,\nu}$**

Let \mathcal{D} be the space of test functions (compactly supported C^∞ functions on $(0, \infty)$) and $\mathcal{D}(0, x)$ be the test functions on $(0, x)$.

We say that $f \in \mathcal{D}'$ is a **staircase distribution** if for any $k = 0, 1, 2, \dots$ there is an L^1 function on $[0, k + 1]$ so that $f = F_k^{(km)}$ (in the sense of distributions) when restricted to $\mathcal{D}(0, k + 1)$ or

$$F_k := \mathcal{P}^{mk} f \in L_1(0, k + 1) \tag{5.294}$$

(since $f \in L^1_{\text{loc}}[0, 1 - \epsilon]$ and $\mathcal{P}f$ is well defined, [23]). With this choice we have

$$F_{k+1} = \mathcal{P}^m F_k \text{ on } [0, k] \text{ and } F_k^{(j)}(0) = 0 \text{ for } j \leq mk - 1 \tag{5.295}$$

Remark 5.296 This space is natural to singular convolution equations arising in ODEs. The solutions are generically singular when $p = n\lambda$ where λ is an eigenvalue of $\hat{\Lambda}$ and $n \in \mathbb{N}^+$. If the singularity at λ is nonintegrable, so are generically the singularities at multiples of it, and the strength of the singularity (such as the order of the pole) grows linearly in n .

We denote these distributions by \mathcal{D}'_m ($\mathcal{D}'_m(0, k)$ respectively, when restricted to $\mathcal{D}(0, k)$) and observe that $\bigcup_{m>0} \mathcal{D}'_m \supset S'$, the distributions of slow growth. The inclusion is strict since any element of S' is of finite order.

Let $f \in L^1$. Taking $F = \mathcal{P}^j f \in C^j$ we have, by integration by parts and noting that the boundary terms vanish,

$$(F * F)(p) = \int_0^p F(s)F(p - s)ds = \int_0^p F^{(j)}(s)\mathcal{P}^j F(p - s) \tag{5.297}$$

so that $F * F \in C^{2j}$ and

$$(F * F)^{(2j)} = f * f \tag{5.298}$$

This motivates the following definition: for $f, \tilde{f} \in \mathcal{D}'_m$ let

$$f * \tilde{f} := (F_k * \tilde{F}_k)^{(2km)} \text{ in } \mathcal{D}'(0, k + 1) \tag{5.299}$$

We first check that the definition is consistent in the sense that

$$(F_{k+1} * F_{k+1})^{(2m(k+1))} = (F_k * F_k)^{(2mk)}$$

on $\mathcal{D}(0, k + 1)$. For $p < k + 1$ integrating by parts and using (5.295) we obtain

$$\frac{d^{2m(k+1)}}{dp^{2m(k+1)}} \int_0^p F_k(s)\mathcal{P}^{2m}\tilde{F}_k(p - s)ds = \frac{d^{2mk}}{dp^{2mk}} \int_0^p F_k(s)\tilde{F}_k(p - s)ds \tag{5.300}$$

The same argument shows that the definition is compatible with the embedding of \mathcal{D}'_m in $\mathcal{D}'_{m'}$ with $m' > m$. Convolution is commutative and associative: with $f, g, h \in \mathcal{D}'_m$ and identifying $(f * g)$ and h by the natural inclusion with elements in \mathcal{D}'_{2m} we obtain $(f * g) * h = ((F * G) * H)^{(4mk)} = f * (g * h)$.

Note 5.301 *The construction is over \mathbb{R}^+ ; the delta distribution at zero for instance is not obtained in this way.*

The following staircase decomposition exists in \mathcal{D}'_m .

Lemma 5.302 *For each $f \in \mathcal{D}'_m$ there is a unique sequence $\{\Delta_i\}_{i=0,1,\dots}$ such that $\Delta_i \in L^1(\mathbb{R}^+)$, $\Delta_i = \Delta_i \chi_{[i,i+1]}$ and*

$$f = \sum_{i=0}^{\infty} \Delta_i^{(mi)} \tag{5.303}$$

Also (cf. (5.295)),

$$F_i = \sum_{j \leq i} \mathcal{P}^{m(i-j)} \Delta_j \text{ on } [0, i + 1] \tag{5.304}$$

Note that the infinite sum is \mathcal{D}' -convergent since for a given test function only a finite number of distributions are nonzero.

Proof

We start by showing (5.304). For $i = 0$ we take $\Delta_0 = F_0 \chi_{[0, 1]}$ (where $F_0 \chi_{[0, 1]} := \phi \mapsto \int_0^1 F_0(s) \phi(s) ds$). Assuming (5.304) holds for $i < n$ we simply note that

$$\begin{aligned} \Delta_n &:= \chi_{[0,n+1]} \left(F_n - \sum_{j \leq n-1} \mathcal{P}^{m(n-j)} \Delta_j \right) \\ &= \chi_{[0,n+1]} \left(F_n - \mathcal{P}^m(F_{n-1} \chi_{[0,n]}) \right) = \chi_{[n,n+1]} \left(F_n - \mathcal{P}^m(F_{n-1} \chi_{[0,n]}) \right) \end{aligned} \tag{5.305}$$

(with $\chi_{[n,\infty]} F_n$ defined in the same way as $F_0 \chi_{[0, 1]}$ above) has, by the induction hypothesis and (5.295) the required properties. Relation (5.303) is immediate. It remains to show uniqueness. Assuming (5.303) holds for the sequences $\Delta_i, \tilde{\Delta}_i$ and restricting f to $\mathcal{D}(0, 1)$ we see that $\Delta_0 = \tilde{\Delta}_0$. Assuming $\Delta_i = \tilde{\Delta}_i$ for $i < n$ we then have $\Delta_n^{(mn)} = \tilde{\Delta}_n^{(mn)}$ on $\mathcal{D}(0, n + 1)$. It follows ([23]) that $\Delta_n(x) = \tilde{\Delta}_n(x) + P(x)$ on $[0, n + 1]$ where P is a polynomial (of degree $< mn$). Since by definition $\Delta_n(x) = \tilde{\Delta}_n(x) = 0$ for $x < n$ we have $\Delta_n = \tilde{\Delta}_n(x)$. \square

The expression (5.299) hints to decrease in regularity, but this is not the case. In fact, we check that the regularity of convolution is not worse than that of its arguments.

Remark 5.306

$$(\cdot * \cdot) : \mathcal{D}_n \mapsto \mathcal{D}_n \tag{5.307}$$

Since

$$\chi_{[a,b]} * \chi_{[a',b']} = \left(\chi_{[a,b]} * \chi_{[a',b']} \right) \chi_{[a+a',b+b']} \tag{5.308}$$

we have

$$F * \tilde{F} = \sum_{j+k \leq [p]} \mathcal{P}^{m(i-j)} \Delta_j * \mathcal{P}^{m(i-k)} \tilde{\Delta}_k = \sum_{j+k \leq [p]} \Delta_j * \mathcal{P}^{m(2i-j-k)} \tilde{\Delta}_k \tag{5.309}$$

which is manifestly in $C^{2mi-m(j+k)}[0, p] \subset C^{2mi-m[p]}[0, p)$.

□

5.12.1 Norms on \mathcal{D}'_m

For $f \in \mathcal{D}'_m$ define

$$\|f\|_{\nu,m} := c_m \sum_{i=0}^{\infty} \nu^{im} \|\Delta_i\|_{L^1_{\nu}} \tag{5.310}$$

(the constant c_m , immaterial for the moment, is defined in (5.323)). When no confusion is possible we will simply write $\|f\|_{\nu}$ for $\|f\|_{\nu,m}$ and $\|\Delta\|_{\nu}$ for $\|\Delta_i\|_{L^1_{\nu}}$ (no other norm is used for the Δ s). Let $\mathcal{D}'_{m,\nu}$ be the distributions in \mathcal{D}'_m such that $\|f\|_{\nu} < \infty$.

Remark 5.311 $\|\cdot\|_{\nu}$ is a norm on $\mathcal{D}'_{m,\nu}$.

If $\|f\|_{\nu} = 0$ for all i , then $\Delta_i = 0$ whence $f = 0$. In view of Lemma 5.302 we have $\|0\|_{\nu} = 0$. All the other properties are immediate.

Remark 5.312 $\mathcal{D}'_{m,\nu}$ is a Banach space. The topology given by $\|\cdot\|_{\nu}$ on $\mathcal{D}'_{m,\nu}$ is stronger than the topology inherited from \mathcal{D}' .

Proof. If we let $\mathcal{D}'_{m,\nu}(k, k + 1)$ be the subset of $\mathcal{D}'_{m,\nu}$ where all $\Delta_i = 0$ except for $i = k$, with the norm (5.310), we have

$$\mathcal{D}'_{m,\nu} = \bigoplus_{k=0}^{\infty} \mathcal{D}'_{m,\nu}(k, k + 1) \tag{5.313}$$

and we only need to check completeness of each $\mathcal{D}'_{m,\nu}(k, k + 1)$ which is immediate: on $L^1[k, k + 1]$, $\|\cdot\|_\nu$ is equivalent to the usual L^1 norm and thus if $f_n \in \mathcal{D}'_{m,\nu}(k, k + 1)$ is a Cauchy sequence, then $\Delta_{k,n} \xrightarrow{L^\nu} \Delta_k$ (whence weak convergence) and $f_n \xrightarrow{\mathcal{D}'_{m,\nu}(k,k+1)} f$ where $f = \Delta_k^{(mk)}$. □

Lemma 5.314 *The space $\mathcal{D}'_{m,\nu}$ is a C^* algebra with respect to convolution.*

Proof. Let $f, \tilde{f} \in \mathcal{D}'_{m,\nu}$ with

$$f = \sum_{i=0}^{\infty} \Delta_i^{(mi)} \quad , \quad \tilde{f} = \sum_{i=0}^{\infty} \tilde{\Delta}_i^{(mi)}$$

Then

$$f * \tilde{f} = \sum_{i,j=0}^{\infty} \Delta_i^{(mi)} * \tilde{\Delta}_j^{(mj)} = \sum_{i,j=0}^{\infty} \left(\Delta_i * \tilde{\Delta}_j \right)^{m(i+j)} \tag{5.315}$$

and the support of $\Delta_i * \tilde{\Delta}_j$ is in $[i+j, i+j+2]$, i.e., $\Delta_i * \tilde{\Delta}_j = \chi_{[i+j, i+j+2]} \Delta_i * \tilde{\Delta}_j$.

We first evaluate the norm in $\mathcal{D}'_{m,\nu}$ of the terms $\left(\Delta_i * \tilde{\Delta}_j \right)^{m(i+j)}$.

I. Decomposition formula. Let $f = F^{(mk)} \in \mathcal{D}'(\mathbb{R}_+)$, where $F \in L^1(\mathbb{R}_+)$, and F is supported in $[k, k + 2]$, i.e., $F = \chi_{[k, k+2]} F$ ($k \geq 0$). Then $f \in \mathcal{D}'_m$ and the decomposition of f (cf. (5.303)) has the terms:

$$\Delta_0 = \Delta_1 = \dots = \Delta_{k-1} = 0, \quad \Delta_k = \chi_{[k, k+1]} F \tag{5.316}$$

and

$$\Delta_{k+n} = \chi_{[k+n, k+n+1]} G_n, \quad \text{where } G_n = \mathcal{P}^m \left(\chi_{[k+n, \infty)} G_{n-1} \right), \quad G_0 = F \tag{5.317}$$

Proof of the decomposition formula. We use first line of (2.98) of the paper

$$\Delta_j = \chi_{[j, j+1]} \left(F_j - \sum_{i=0}^{j-1} \mathcal{P}^{m(j-i)} \Delta_i \right) \tag{5.318}$$

where, in our case, $F_k = F$, $F_{k+1} = \mathcal{P}^m F$, ..., $F_{k+n} = \mathcal{P}^{mn} F$, ...

The relations (5.316) follow directly from (5.318). Formula (5.317) is shown by induction on n . For $n = 1$ we have

$$\begin{aligned} \Delta_{k+1} &= \chi_{[k+1, k+2]} \left(\mathcal{P}^m F - \mathcal{P}^m \Delta_k \right) \\ &= \chi_{[k+1, k+2]} \mathcal{P}^m \left(\chi_{[k, \infty)} F - \chi_{[k, k+1]} F \right) = \chi_{[k+1, k+2]} \mathcal{P}^m \left(\chi_{[k+1, \infty)} F \right) \end{aligned}$$

Assume (5.317) holds for Δ_{k+j} , $j \leq n-1$. Using (5.318), with $\chi = \chi_{[k+n, k+n+1]}$ we have

$$\Delta_{k+n} = \chi \left(\mathcal{P}^{mn} F - \sum_{i=k}^{n-1} \mathcal{P}^{m(n-i)} \Delta_i \right) = \chi \mathcal{P}^m (G_{n-1} - \Delta_{n-1})$$

$$= \chi \mathcal{P}^m \left(\chi_{[k+n-1, \infty)} G_{n-1} - \chi_{[k+n-1, k+n]} G_{n-1} \right) = \chi \mathcal{P}^m \left(\chi_{[k+n, \infty)} G_{n-1} \right) \quad \square$$

II. Estimating Δ_{k+n} . For f as in **I**, we have

$$\|\Delta_{k+1}\|_\nu \leq \nu^{-m} \|F\|_\nu, \quad \|\Delta_{k+2}\|_\nu \leq \nu^{-2m} \|F\|_\nu \tag{5.319}$$

and, for $n \geq 3$

$$\|\Delta_{k+n}\|_\nu \leq e^{2\nu-n\nu} (n-1)^{nm-1} \frac{1}{(nm-1)!} \|F\|_\nu \tag{5.320}$$

Proof of estimates of Δ_{k+n} .

(A) Case $n = 1$.

$$\begin{aligned} \|\Delta_{k+1}\|_\nu &\leq \int_{k+1}^{k+2} dt e^{-\nu t} \mathcal{P}^m \left(\chi_{[k+1, \infty)} |F| \right) (t) \\ &= \int_{k+1}^{k+2} dt e^{-\nu t} \int_{k+1}^t ds_1 \int_{k+1}^{s_1} ds_2 \dots \int_{k+1}^{s_{m-1}} ds_m |F(s_m)| \\ &\leq \int_{k+1}^{k+2} ds_m |F(s_m)| \int_{s_m}^\infty ds_{m-1} \dots \int_{s_2}^\infty ds_1 \int_{s_1}^\infty dt e^{-\nu t} \\ &= \int_{k+1}^{k+2} ds_m |F(s_m)| e^{-\nu s_m} \nu^{-m} \leq \nu^{-m} \|F\|_\nu \end{aligned} \tag{5.321}$$

(B) Case $n = 2$:

$$\begin{aligned} \|\Delta_{k+1}\|_\nu &\leq \int_{k+2}^{k+3} dt e^{-\nu t} \mathcal{P}^m \left(\chi_{[k+2, \infty)} \mathcal{P}^m \left(\chi_{[k+1, \infty)} |F| \right) \right) \\ &= \int_{k+2}^{k+3} dt e^{-\nu t} \int_{k+2}^t dt_1 \int_{k+2}^{t_1} dt_2 \dots \int_{k+2}^{t_{m-1}} dt_m \\ &\quad \times \int_{k+1}^{t_m} ds_1 \int_{k+1}^{s_1} ds_2 \dots \int_{k+1}^{s_{m-1}} ds_m |F(s_m)| \\ &\leq \int_{k+2}^{k+3} ds_m |F(s_m)| \int_{s_m}^\infty ds_{m-1} \dots \int_{s_2}^\infty ds_1 \int_{\max\{s_1, k+2\}}^\infty dt_m \\ &\quad \times \int_{t_m}^\infty dt_{m-1} \dots \int_{t_1}^\infty dt e^{-\nu t} \end{aligned}$$

$$\begin{aligned}
 &= \int_{k+2}^{k+3} ds_m |F(s_m)| \int_{s_m}^{\infty} ds_{m-1} \dots \int_{s_2}^{\infty} ds_1 e^{-\nu \max\{s_1, k+2\}} \nu^{-m-1} \\
 &\leq \int_{k+2}^{k+3} ds_m |F(s_m)| \int_{s_m}^{\infty} ds_{m-1} \dots \int_{s_3}^{\infty} ds_2 e^{-\nu s_2} \nu^{-m-2} \\
 &= \int_{k+2}^{k+3} ds_m |F(s_m)| e^{-\nu s_m} \nu^{-2m}
 \end{aligned}$$

(C) Case $n \geq 3$. We first estimate G_2, \dots, G_n :

$$|G_2(t)| \leq \mathcal{P}^m \left(\chi_{[k+2, \infty)} \mathcal{P}^m \left(\chi_{[k+1, \infty)} |F| \right) \right) (t)$$

$$= \int_{k+2}^t dt_1 \int_{k+2}^{t_1} dt_2 \dots \int_{k+2}^{t_{m-1}} dt_m \int_{k+1}^{t_m} ds_1 \int_{k+1}^{s_1} ds_2 \dots \int_{k+1}^{s_{m-1}} ds_m |F(s_m)|$$

and using the inequality

$$|F(s_m)| = |F(s_m)| \chi_{[k, k+2]}(s_m) \leq |F(s_m)| e^{-\nu s_m} e^{\nu(k+2)}$$

we get

$$\begin{aligned}
 |G_2(t)| &\leq e^{\nu(k+2)} \|F\|_{\nu} \int_{k+1}^t dt_1 \int_{k+1}^{t_1} dt_2 \dots \\
 &\quad \times \int_{k+1}^{t_{m-1}} dt_m \int_{k+1}^{t_m} ds_1 \int_{k+1}^{s_1} ds_2 \dots \int_{k+1}^{s_{m-2}} ds_{m-1}
 \end{aligned}$$

$$\begin{aligned}
 |G_2(t)| &\leq e^{\nu(k+2)} \|F\|_{\nu} \int_{k+1}^t dt_1 \int_{k+1}^{t_1} dt_2 \dots \int_{k+1}^{t_{m-1}} dt_m \\
 &\quad \times \int_{k+1}^{t_m} ds_1 \int_{k+1}^{s_1} ds_2 \dots \int_{k+1}^{s_{m-2}} ds_{m-1} \\
 &= e^{\nu(k+2)} \|F\|_{\nu} (t - k - 1)^{2m-1} \frac{1}{(2m - 1)!}
 \end{aligned}$$

The estimate of G_2 is used for bounding G_3 :

$$\begin{aligned}
 |G_3(t)| &\leq \mathcal{P}^m \left(\chi_{[k+3, \infty)} |G_2| \right) \leq \mathcal{P}^m \left(\chi_{[k+1, \infty)} |G_2| \right) \\
 &\leq e^{\nu(k+2)} \|F\|_{\nu} (t - k - 1)^{3m-1} \frac{1}{(3m - 1)!}
 \end{aligned}$$

and similarly (by induction)

$$|G_n(t)| \leq e^{\nu(k+2)} \|F\|_{\nu} (t - k - 1)^{nm-1} \frac{1}{(nm - 1)!}$$

Then

$$\|\Delta_{k+n}\|_{\nu} \leq e^{\nu(k+2)} \|F\|_{\nu} \frac{1}{(nm - 1)!} \int_{k+n}^{k+n+1} dt e^{-\nu t} (t - k - 1)^{nm-1}$$

and, for $\nu \geq m$ the integrand is decreasing, and the inequality (5.320) follows.

III. Final Estimate. Let $\nu_0 > m$ be fixed. For f as in **I**, we have for any $\nu > \nu_0$,

$$\|f\| \leq c_m \nu^{km} \|F\|_{\nu} \tag{5.322}$$

for some c_m , if $\nu > \nu_0 > m$.

Proof of Final Estimate

$$\|f\| = \sum_{n \geq 0} \nu^{km+kn} \|\Delta_{k+n}\|_{\nu} \leq \nu^{km} \|F\|_{\nu} \left[3 + \sum_{n \geq 3} \nu^{nm} e^{2\nu-n\nu} \frac{(n-1)^{nm-1}}{(nm-1)!} \right]$$

and, using $n - 1 \leq (mn - 1)/m$ and a crude Stirling estimate we obtain

$$\|f\| \leq \nu^{km} \|F\|_{\nu} \left[3 + m e^{2\nu-1} \sum_{n \geq 3} (e^{m-\nu} \nu^m / m^m)^n \right] \leq c_m \nu^{km} \|F\|_{\nu} \tag{5.323}$$

Thus (5.322) is proven for $\nu > \nu_0 > m$.

End of the proof. From (5.315) and (5.322) we get

$$\begin{aligned} \|f * \tilde{f}\| &\leq \sum_{i,j=0}^{\infty} \|(\Delta_i * \tilde{\Delta}_j)^{m(i+j)}\| \\ &\leq \sum_{i,j=0}^{\infty} c_m^2 \nu^{m(i+j)} \|\Delta_i * \tilde{\Delta}_j\|_{\nu} \leq c_m^2 \sum_{i,j=0}^{\infty} \nu^{m(i+j)} \|\Delta_i\|_{\nu} \|\tilde{\Delta}_j\|_{\nu} = c_m^2 \|f\| \|\tilde{f}\| \quad \square \end{aligned}$$

Remark 5.324 Let $f \in \mathcal{D}'_{m,\nu}$ for some $\nu > \nu_0$ where $\nu_0^m = e^{\nu_0}$. Then $f \in \mathcal{D}'_{m,\nu'}$ for all $\nu' > \nu$ and furthermore,

$$\|f\|_{\nu} \downarrow 0 \text{ as } \nu \uparrow \infty \tag{5.325}$$

Proof. We have

$$\nu^{mk} \int_k^{k+1} |\Delta_k(s)| e^{-\nu s} ds = (\nu^m e^{-\nu})^k \int_0^1 |\Delta_k(s+k)| e^{-\nu s} ds \tag{5.326}$$

which is decreasing in ν . The rest follows from the monotone convergence theorem. □

5.12.2 Embedding of L^1_ν in \mathcal{D}'_m

Lemma 5.327 (i) Let $f \in L^1_{\nu_0}$ (cf. Remark 5.324). Then $f \in \mathcal{D}'_{m,\nu}$ for all $\nu > \nu_0$.

(ii) $\mathcal{D}(\mathbb{R}^+ \setminus \mathbb{N}) \cap L^1_\nu(\mathbb{R}^+)$ is dense in $\mathcal{D}_{m,\nu}$ with respect to the norm $\|\cdot\|_\nu$.

Proof.

Note that if for some ν_0 we have $f \in L^1_{\nu_0}(\mathbb{R}^+)$, then

$$\int_0^p |f(s)| ds \leq e^{\nu_0 p} \int_0^p |f(s)| e^{-\nu_0 s} ds \leq e^{\nu_0 p} \|f\|_{\nu_0} \tag{5.328}$$

to which, application of \mathcal{P}^{k-1} yields

$$\mathcal{P}^k |f| \leq \nu_0^{-k+1} e^{\nu_0 p} \|f\|_{\nu_0} \tag{5.329}$$

Also, $\mathcal{P}\chi_{[n,\infty)} e^{\nu_0 p} \leq \nu_0^{-1} \chi_{[n,\infty)} e^{\nu_0 p}$ so that

$$\mathcal{P}^m \chi_{[n,\infty)} e^{\nu_0 p} \leq \nu_0^{-m} \chi_{[n,\infty)} e^{\nu_0 p} \tag{5.330}$$

so that, by (5.305) (where now F_n and $\chi_{[n,\infty)} F_n$ are in $L^1_{\text{loc}}(0, n+1)$) we have for $n > 1$,

$$|\Delta_n| \leq \|f\|_{\nu_0} e^{\nu_0 p} \nu_0^{1-mn} \chi_{[n,n+1]} \tag{5.331}$$

Let now ν be large enough. We have

$$\begin{aligned} \sum_{n=2}^\infty \nu^{mn} \int_0^\infty |\Delta_n| e^{-\nu p} dp &\leq \nu_0 \|f\|_{\nu_0} \sum_{n=2}^\infty \int_n^{n+1} e^{-(\nu-\nu_0)p} \left(\frac{\nu}{\nu_0}\right)^p dp \\ &= \frac{e^{-2(\nu-\nu_0-\ln(\nu/\nu_0))}}{\nu-\nu_0-\ln(\nu/\nu_0)} \nu_0 \|f\|_{\nu_0} \end{aligned} \tag{5.332}$$

For $n = 0$ we simply have $\|\Delta_0\| \leq \|f\|$, while for $n = 1$ we write

$$\|\Delta_1\|_\nu \leq \|1^{*(m-1)} * |f|\|_\nu \leq \nu^{m-1} \|f\|_\nu \tag{5.333}$$

Combining the estimates above, the proof of (i) is complete. To show (ii), let $f \in \mathcal{D}'_{m,\nu}$ and let k_ϵ be such that $c_m \sum_{i=k_\epsilon}^\infty \nu^{im} \|\Delta_i\|_\nu < \epsilon$. For each $i \leq k_\epsilon$ we take a function δ_i in $\mathcal{D}(i, i+1)$ such that $\|\delta_i - \Delta_i\|_\nu < \epsilon 2^{-i}$. Then $\|f - \sum_{i=0}^{k_\epsilon} \delta_i^{(mi)}\|_{m,\nu} < 2\epsilon$. \square

The proof of continuity of $f(p) \mapsto pf(p)$: If $f(p) = \sum_{k=0}^\infty \Delta_k^{(mk)}$ then $pf = \sum_{k=0}^\infty (p\Delta_k)^{(mk)} - \sum_{k=0}^\infty mk\mathcal{P}(\Delta_k^{(mk)}) = \sum_{k=0}^\infty (p\Delta_k^{(mk)}) - 1 * \sum_{k=0}^\infty (mk\Delta_k)^{(mk)}$. The rest is obvious from continuity of convolution, the embedding shown above and the definition of the norms.

Chapter 6

Asymptotic and transasymptotic matching; formation of singularities

Transasymptotic matching stands for matching at the level of transseries. Matching can be exact, in that a BE summable transseries, valid in one region, is matched to another BE summable transseries, valid in an adjacent region, or asymptotic, when a transseries is matched to a classical asymptotic expansion. An example of exact matching is (5.122), with the connection formula (5.123), valid for systems of ODEs. In this case the two transseries exactly represent one function, and the process is very similar to analytic continuation; it is a process of continuation through transseries.

The collection of matched transseries represents exactly the function on the union of their domain of validity. In the case of *linear* ODEs, matching is global, in that it is valid in a full (ramified, since the solution might not be single-valued) neighborhood of infinity. In this case, by the results in Chapter 5 we see that for any ϕ we have

$$\mathbf{y} = \mathcal{L}_\phi \mathbf{Y}_0^+ + \sum_{|\mathbf{k}|=1} \mathbf{C}^{\mathbf{k}} e^{-\mathbf{k} \cdot \lambda x} x^{\mathbf{k} \cdot \alpha} \mathcal{L}_\phi \mathbf{Y}_{\mathbf{k}}^+ \quad (6.1)$$

where we note that (due to linearity) the right side of (6.1) has finitely many terms. If ϕ corresponds to a Stokes ray, \mathcal{L}_ϕ is understood as the balanced average. For linear systems, the Stokes rays are precisely the directions of the $\overline{\lambda}_i, i = 1, \dots, n$, that is, the directions along which $x\lambda_i \in \mathbb{R}^+$. Along the direction $\overline{\lambda}_i$, the constant C_i in the transseries changes; see (5.123). Up to the changes in \mathbf{C} , the representation (6.1) is uniform in a ramified neighborhood of infinity.

We emphasized linear, since solutions of nonlinear ODEs usually develop **infinitely many singularities** as we shall see, and even natural boundaries in a neighborhood of infinity, and in the latter case transasymptotic matching often ends there (though at times it suggests pseudo-analytic continuation formulas.) The information contained in the transseries suffices to determine, very accurately for large values of the variable, the position and often the type of singularities. We first look at a number of simple examples, which should provide the main ideas for a more general analysis, found in [24] together with rigorous proofs.

A simple example of transasymptotic matching showing formation of singularities, for linear *difference* equations, is seen in §4.4e.

6.0a Transseries and singularities: Discussion

For nonlinear systems, a solution described by a transseries in a region given by the conditions (c1) of §5.6b usually forms *quasiperiodic arrays of singularities* on the edges of *formal* validity of the transseries. (Note that the change seen in (5.123) lies well *within* the domain of validity of the transseries.)

Assume $\mathbf{y}' = \mathbf{f}(1/x, \mathbf{y})$ is a nonlinear system, with an irregular singularity at infinity, and which is amenable to the normal form studied in Chapter 5, with $\lambda_1 = 1$. Assume $t = x^r$ is the critical time needed for normalization and \mathbf{y}_0 is a solution which decays along the Stokes ray \mathbb{R}^+ . Then this solution generically develops arrays of singularities near the line $x^r \in i\mathbb{R}$ (that is, close to the corresponding antistokes rays). The singularity position is, to leading order, periodic in x^r . The precise location is a function of the constant \mathbf{C} in the transseries, that is on the size of exponentially small terms on the Stokes ray.

These actual singularities are reflections of the Borel plane singularities. Say, the equation is of the form

$$y'' = \lambda^2 y + A(1/x, y) \tag{6.2}$$

with $\lambda > 0$, $A(z_1, z_2)$ analytic at 0, nonlinear in z_2 and of order $O(z_1^2, z_2^2)$ for small \mathbf{z} . Written as a system, (6.2) satisfies the assumptions in Chapter 5. Then, there is a one parameter family of solutions $y(x; C_+)$ which decay in \mathbb{H} and these, by Chapter 5, and in the notation (5.33) can be written in the form

$$y_0^+ + \sum_{k=1}^{\infty} C_+^k e^{-\lambda k x} y_k^+(x)$$

where y_k^+ are Borel summed series. When $\lambda x \sim i|x| + \ln C_+$, the exponentials become $O(1)$ and the sum above usually diverges. Then, see Proposition 6.19, $y(x, C_+)$ is singular at all points in an array asymptotically given by

$$\lambda x_n = 2n\pi i + \ln C_+ + o(1) \quad (n \rightarrow +\infty) \tag{6.3}$$

and it is analytic in-between the points in the array, where the constant c_1 depends only on the equation. This is a “first” array of singularities and to the left of it other arrays can be found similarly.

Note, in comparison, that the singularities of $\mathcal{L}^{-1}y_0$ are located at $p_n = n\lambda, n \in \mathbb{Z} \setminus \{0\}$.

See also (6.64), valid for the Painlevé equation P_I and Fig. 6.4.

6.1 Transseries reexpansion and singularities. Abel's equation

We examine Abel's equation (5.52); its normal form is (5.59). We write the decaying formal asymptotic series solution as

$$y \sim \sum_{j=2}^{\infty} \frac{a_{j,0}}{x^j} \equiv \tilde{y}_0(x) \tag{6.4}$$

where $a_{j,0}$ can be determined algorithmically, and their values are immaterial for now. If y_0 is a particular solution to (5.58) with asymptotic series \tilde{y}_0 then, y_0 and $y_0 + \delta$ will have the same asymptotic series if $\delta = o(x^{-n})$ for any n , i.e., if δ is a term beyond all orders for the asymptotic series \tilde{y}_0 . Furthermore, δ satisfies

$$\delta' = -\delta + \frac{1}{5x} \delta \tag{6.5}$$

which has the solution $\delta \sim Cx^{1/5}e^{-x}$, where C is an arbitrary constant. The full transseries solution is obtained as usual by substituting

$$\tilde{y} = \tilde{y}_0 + \sum_{k=1}^{\infty} C^k x^{k/5} e^{-kx} \tilde{y}_k \tag{6.6}$$

in (5.58) and equating coefficients of e^{-kx} to determine a set of differential equations for \tilde{y}_k , in which we look for solutions which are not exponentially growing in \mathbb{H} ; the only such solutions are of the form

$$\tilde{y}_k = \sum_{j=0}^{\infty} \frac{a_{j,k}}{x^j} \tag{6.7}$$

Arbitrariness only appears in the choice of $a_{0,1}$; all other coefficients are determined recursively. Since C is arbitrary, there is no loss of generality in setting $a_{0,1} = 1$. We rewrite the transseries (6.6) in the form

$$\tilde{y}_0(x) + \sum_{k=1}^{\infty} C^k \xi^k \tilde{y}_k(x) \tag{6.8}$$

with $\xi = x^{1/5}e^{-x}$. By Theorem 5.67, (6.8) is Borel summable in the first quadrant, and

$$y = y_0(x) + \sum_{k=1}^{\infty} C_+^k \xi^k y_k^+(x) \tag{6.9}$$

where

$$y_k^+(x) = \mathcal{L}Y_k^+ = \int_{e^{-i0}\mathbb{R}_+} e^{-px} Y_k^+(p) dp = \mathcal{L}\mathcal{B}_+ \tilde{y}_k \tag{6.10}$$

and

$$Y_k(p) = \mathcal{B}[\tilde{y}_k] \tag{6.11}$$

Note. To simplify notation, we drop the “+” in the notations whenever it is clear that in our analysis x is in the first quadrant.

By the definition of Borel summation, the contours in the Laplace transforms in (6.10) are taken so that $-px$ is real and negative. Thus, analytic continuation in x in the upper half-plane means continuation in p in opposite direction, in the lower half-plane (since, in the definition of Borel summation we have $xp > 0$). We note, again using Theorem 5.67 that Y_k are analytic $\mathbb{C} \setminus \mathbb{R}^+$. Then, y_k are analytic in x (and bounded by some c^k) in a sector with angles $(-\pi/2, 5\pi/2)$.

Convergence of the series (6.8) depends in an essential way on the size of **effective variable** ξ . The solution $y(x)$ is analytic in a sector in \mathbb{H} of any angle $< \pi$. But ξ becomes large in the left half-plane. The series is not expected to converge there.

The key to understanding the behavior of $y(x)$ for x beyond its analyticity region is to look carefully at the borderline region, where (6.9) barely converges, and see what expansion is adequate there and beyond. Convergence is marginal along curves so that ξ is small enough, but as $|x| \rightarrow \infty$, is nevertheless larger than all *negative* powers of x . In this case, any term in the transseries of the form $\xi^k a_{0,k}$ is larger than any other term of the form $\xi^l a_{j,l} x^{-j}$, if $k, l \geq 0$ and $j > 0$. Then though the transseries is still valid, and its summation converges, the terms are disordered: smaller terms are followed by both smaller and larger terms.

The natural thing to do is to properly reorder the terms. The rearranged expansion is suited for this marginal region, and as it turns out, beyond it as well.

In the aforementioned domain, the largest terms are those containing no inverse power of x , namely

$$y(x) \sim \sum_{k \geq 0} \xi^k a_{0,k} \equiv F_0(\xi) \tag{6.12}$$

Next in line, insofar as orders of magnitudes are concerned, are the terms containing only the first power of x^{-1} and any power of ξ , followed by the group of terms containing x^{-2} and any power of ξ and so on. The result of rearrangement is

$$y(x) \sim \sum_{j=0}^{\infty} x^{-j} \sum_{k=0}^{\infty} \xi^k a_{j,k} \equiv \sum_{j=0}^{\infty} \frac{F_j(\xi)}{x^j} \tag{6.13}$$

This is a new type of expansion, valid in a region as depicted in Fig. 6.1. It is intuitively clear that the region of validity of (6.13), while overlapping as expected with the transseries region, goes beyond it. This is because unless ξ approaches some singular value of F_j , F_j is much smaller than x . By the

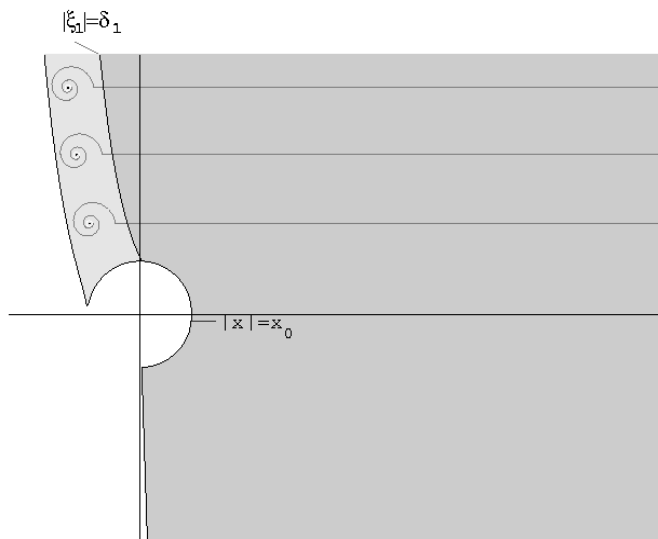

FIGURE 6.1: The region of validity of the F_k expansion.

same token, we can read, with high accuracy, the location of the singularities of y from this expansion.

The new expansion (6.13) will usually break down further on, in which case we do exactly the same, namely push the expansion close to its boundary of validity, rearrange the terms there and obtaining a new expansion. This works until true singularities of y are reached.

The expansion (6.13) has a two-scale structure, with scales ξ and x , with the ξ -series of each F_j analytic in ξ for small ξ . This may seem paradoxical, as it suggests that we have started with a series with zero radius of convergence and ended up, by mere rearrangement, with a convergent one. This is not the case. The new series still diverges factorially, because F_k as a function of k grows factorially.

6.2 Determining the ξ reexpansion in practice

In §6.1 we have found (6.13) by rearranging the series by hand. This procedure is quite cumbersome; there is a better way to obtain (6.13).

Namely, now that we know how the expansion should look like, we can

substitute (6.13) in the original differential equation and identify the terms order by order in $1/x$, thinking of ξ as an independent variable. In view of the simple changes of coordinates involved, we can make this substitution in (5.57), which is simpler.

We obtain

$$9\xi F'_0 = (3F_0)^3 - 1; \quad F'_0(0) = 1; \quad F_0(0) = 1/3 \tag{6.14}$$

while for $k \geq 1$ we have

$$-\xi F'_k + 9F_0^2 F_k = \left(k - 1 - \frac{\xi}{5}\right) F'_{k-1} + \sum_{\substack{j_1+j_2+j_3=k \\ j_i \neq 0}} F_{j_1} F_{j_2} F_{j_3} \tag{6.15}$$

The condition $F'_0(0) = 1$ comes from the fact that the coefficient of $\xi = Ce^{-x}x^{1/5}$ in the transseries is one, while $F_0(0) = h(\infty)$. Of course, the equation for F_0 can be solved in closed form. First we treat it abstractly. If we take $F_0 = 1/3 + \xi G$, then it can be written in integral form as

$$G = 1 + 3\xi \int_0^\xi (G^2(s) + G^3(s)) ds \tag{6.16}$$

which is contractive in the ball of radius say 2 in the sup norm of functions analytic in ξ for $|\xi| < \epsilon$, for small enough ϵ . Thus F_0 is analytic in ξ small, that is, the series (6.12) converges.

We see that the equations for F_k are linear.

Exercise 6.17 Show that for $k = 1$ we have a one-parameter family of solutions which are analytic at $\xi = 0$, of the form $-1/15 + c_1\xi + \dots$. There is a choice of c_1 so that the equation for F_2 has a one-parameter family of solutions analytic at $\xi = 0$, parameterized by c_2 , and by induction there is a choice of c_k so that the equation for F_{k+1} has a one-parameter family of solutions parameterized by c_{k+1} and so on.

Remark 6.18 *With this choice of constants, clearly, F_j is singular only if F_0 is singular.*

6.3 Conditions for formation of singularities

Let

$$\mathbb{D}_r = \{x : |x| < r\}$$

Proposition 6.19 *Let $\lambda_1 = 1$ and $\xi = x^\alpha e^{-x}$. Assume F_0 is not entire (this is generic¹). Let \mathbb{D}_r be the maximal disk where F_0 is analytic². Assume $\xi_0 \in \partial\mathbb{D}_r$ is a singular point of F_0 such that F_0 admits analytic continuation in a ramified neighborhood of ξ_0 . Then y is singular at infinitely many points, asymptotically given by*

$$x_n = 2n\pi i + \alpha_1 \ln(2n\pi i) + \ln C - \ln \xi_0 + o(1) \quad (n \rightarrow \infty) \tag{6.20}$$

(recall that $C = C_+$).

Remark 6.21 We note that asymptotically y is a function of $Ce^{-x}x^\alpha$. This means that there are infinitely many singular points, nearly periodic, since the points x so that $Ce^{-x}x^\alpha = \xi_0$ are nearly periodic.

We need the following result which is in some sense a converse of Morera’s theorem.

Lemma 6.22 *Assume that $f(\xi)$ is analytic on the universal covering of $\mathbb{D}_r \setminus \{0\}$. Assume further that for any circle around zero $\mathcal{C} \subset \mathbb{D}_r \setminus \{0\}$ and any $g(\xi)$ analytic in \mathbb{D}_r we have $\oint_{\mathcal{C}} f(\xi)g(\xi)d\xi = 0$. Then f is in fact analytic in \mathbb{D}_r .*

PROOF Let $a \in \mathbb{D}_r \setminus \{0\}$. It follows that $\int_a^\xi f(s)ds$ is single-valued in $\mathbb{D}_r \setminus \{0\}$. Thus f is single-valued and, by Morera’s theorem, analytic in $\mathbb{D}_r \setminus \{0\}$. Since by assumption $\oint_{\mathcal{C}} f(\xi)\xi^n d\xi = 0$ for all $n \geq 0$, there are no negative powers of ξ in the Laurent series of $f(\xi)$ about zero: f extends as an analytic function at zero. □

PROOF of Proposition 6.19

By Lemma 6.22 there is a circle \mathcal{C} around ξ_s and a function $g(\xi)$ analytic in $\mathbb{D}_r(\xi - \xi_s)$ so that $\oint_{\mathcal{C}} F_0(\xi)g(\xi)d\xi = 1$. In a neighborhood of $x_n \in X$ the function $f(x) = e^{-x}x^{\alpha_1}$ is conformal and for large x_n

$$\begin{aligned} &\oint_{f^{-1}(\mathcal{C})} \mathbf{y}(x) \frac{g(f(x))}{f(x)} dx \\ &= - \oint_{\mathcal{C}} (1 + O(x_n^{-1}))(F_0(\xi) + O(x_n^{-1}))g(\xi)d\xi = 1 + O(x_n^{-1}) \neq 0 \end{aligned} \tag{6.23}$$

It follows from Lemma 4.158 that for large enough x_n $y(x)$ is not analytic inside \mathcal{C} either. Since the radius of \mathcal{C} can be taken $o(1)$ the result follows. □

¹After suitable changes of variables; see comments after [Theorem 6.57](#).

²By Theorem 6.57 F_0 is always analytic at zero.

Remark 6.24 Proposition 6.19 extends to the case where F_0 and y are vectors; see §6.5.

Exercise 6.25 (*) Let $X > 0$ be large and $\epsilon > 0$ be small. The expansion (6.12) is asymptotic along any curve of the form in Fig. 6.3 p. 229, provided

- $|x| > X$ along the curve, the length of the curve is $O(X^m)$ and no singularity of F_0 is approached at a distance less than ϵ .

For example, a contractive mapping integral equation can be written for the remainder

$$y(x) - \sum_{j=0}^N \frac{F_j(\xi)}{x^j} \tag{6.26}$$

for N conveniently large.

6.4 Abel’s equation, continued

We define some domains relevant to the singularity analysis:

$$\mathcal{D} = \{|\xi| < K \mid \xi \notin (-\infty, \xi_1) \cup (\xi_0, +\infty), |\xi - \xi_0| > \epsilon, |\xi - \xi_1| > \epsilon, \} \tag{6.27}$$

(for any small $\epsilon > 0$ and large positive K) the corresponding domain in the z -plane is shown in Fig. 6.4.

We fix $\epsilon > 0$ small, and some $K > 0$ and define

$$\mathcal{A}_K = \{z : \arg z \in \left(\frac{3}{10}\pi - 0, \frac{9}{10}\pi + 0\right), |\xi(z)| < K\}$$

and let $\mathcal{R}_{K,\Xi}$ be the universal covering of $\Xi \cap \mathcal{A}_K$ and $\mathcal{R}_{z;K,\epsilon}$ the corresponding Riemann surface in the z plane, with ϵ -neighborhoods of the points projecting on $z(x(\Xi))$ deleted.

Proposition 6.28 (i) *The solutions $u = u(z; C_+)$ of 5.52 which have algebraic behavior in the right half-plane have the asymptotic expansion*

$$u(z) \sim z^{1/3} \left(1 + \frac{1}{9}z^{-5/3} + \sum_{k=0}^{\infty} \frac{F_k(C_+\xi(z))}{z^{5k/3}} \right) \tag{6.29}$$

(as $z \rightarrow \infty; z \in \mathcal{R}_{z;K,\epsilon}$)

where

$$\xi(z) = x(z)^{1/5}e^{-x(z)}, \text{ and } x(z) = -\frac{9}{5}z^{5/3} \tag{6.30}$$

(ii) In the “steep ascent” strips $\arg(\xi) \in (a_1, a_2)$, $|a_2 - a_1| < \pi$ starting in \mathcal{A}_K and crossing the boundary of \mathcal{A}_K , the function u has at most one singularity, when $\xi(z) = \xi_0$ or ξ_1 , and $u(z) = z^{1/3}e^{\pm 2\pi i/3}(1 + o(1))$ as $z \rightarrow \infty$ (the sign is determined by $\arg(\xi)$).

(iii) Up to obvious changes of variables, the singularities of $u(z; C_+)$, for $C_+ \neq 0$, are located within $o(1)$ of the singularities of F_0 , which are described in §6.4a.

We adapt this case to the setting of §6.5, from which the proof follows. The calculations can probably be followed without much reference to that section.

Let $f = F_0 - 1/3$. The equation for $f(\xi)$ is, cf. (6.53),

$$\xi f' = f(1 + 3f + 3f^2); \quad f'(0) = 1 \tag{6.31}$$

so that

$$\xi = \xi_0 f(\xi)(f(\xi) + \omega_0)^{-\theta} (f(\xi) + \overline{\omega_0})^{-\overline{\theta}} \tag{6.32}$$

with $\xi_0 = 3^{-1/2} \exp(-\frac{1}{6}\pi\sqrt{3})$, $\omega_0 = \frac{1}{2} + \frac{i\sqrt{3}}{6}$ and $\theta = \frac{1}{2} + i\frac{\sqrt{3}}{2}$. and, cf. (6.15) and (6.54),

$$\xi F'_k = (3f + 1)^2 F_k + R_k(f, \dots, F_{k-1}) \text{ (for } k \geq 1 \text{ and where } R_1 = \frac{3}{5}f^3) \tag{6.33}$$

The functions F_k , $k \geq 1$ can also be obtained in closed form, order by order.

Remark 6.34 By Theorem 6.57 below, the relation $y \sim \tilde{y}$ holds in the sector

$$S_{\delta_1} = \{x \in \mathbb{C} : \arg(x) \geq -\frac{\pi}{2} + \delta, |C_+ x^{1/5} e^{-x}| < \delta_1\}$$

for some $\delta_1 > 0$ and any small $\delta > 0$. Theorem 6.57 also ensures that $y \sim \tilde{y}$ holds in fact on a larger region, surrounding singularities of F_0 (and thus of y). To apply this result we need the surface of analyticity of F_0 and an estimate for the location of its singularities. We postpone its formulation, which needs more notation, until the study of particular examples motivates that.

Lemma 6.35 (i) The function F_0 is analytic on the universal covering³ \mathcal{R}_Ξ of $\mathbb{C} \setminus \Xi$, where

$$\Xi = \{\xi_p = (-1)^{p_1} \xi_0 \exp(p_2 \pi \sqrt{3}) : p_{1,2} \in \mathbb{Z}\} \tag{6.36}$$

and its singularities are algebraic of order $-1/2$, located at points lying above Ξ . Fig. 6.2 sketches the Riemann surface associated to F_0 .

(ii) (The first Riemann sheet.) The function F_0 is analytic in $\mathbb{C} \setminus \left((-\infty, \xi_0] \cup [\xi_1, \infty) \right)$.

³This consists in classes of curves in \mathbb{C} , where two curves are not considered distinct if they can be continuously deformed into each other without crossing Ξ .

6.4a Singularities of F_0 and proof of Lemma 6.35

The right side of (6.14) is analytic except at $F_0 = \infty$, thus F_0 is analytic except at points where $F_0 \rightarrow \infty$. From (6.32) it follows that $\lim_{F_0 \rightarrow \infty} \xi \in \Xi$ and (i) follows straightforwardly; in particular, as $\xi \rightarrow \xi_p \in \Xi$ we have $(\xi - \xi_p)^{1/2} F_0(\xi) \rightarrow \sqrt{-\xi_p/6}$.

(ii) We now examine on which sheets in \mathcal{R}_Ξ these singularities are located, and start with a study of the first Riemann sheet (where $F_0(\xi) = \xi + O(\xi^2)$ for small ξ). Finding which of the points ξ_p are singularities of F_0 on the first sheet can be rephrased in the following way. On which constant phase (equivalently, steepest ascent/descent) paths of $\xi(F_0)$, which extend to $|F_0| = \infty$ in the plane F_0 , is $\xi(F_0)$ uniformly bounded?

Constant phase paths are governed by the equation $\text{Im}(d \ln \xi) = 0$. Thus, denoting $F_0 = X + iY$, since $\xi'/\xi = (F_0 + 3F_0^2 + 3F_0^3)^{-1}$ one is led to the *real* differential equation $\text{Im}(\xi'/\xi)dX + \text{Re}(\xi'/\xi)dY = 0$ (cf. §3.6a), or

$$Y(1 + 6X + 9X^2 - 3Y^2)dX - (X + 3X^2 - 3Y^2 + 3X^3 - 9XY^2)dY = 0 \quad (6.37)$$

We are interested in the field lines of (6.37) which extend to infinity. Noting that the singularities of the field are $(0, 0)$ (unstable node, in a natural parameterization) and $P_\pm = (-1/2, \pm\sqrt{3}/6)$ (stable foci, corresponding to $-\bar{\omega}_0$ and $-\omega_0$), the phase portrait is easy to draw (see Fig. 6.2) and there are only two curves starting at $(0, 0)$ so that $|F_0| \rightarrow \infty$, ξ bounded, namely $\pm\mathbb{R}^+$, along which $\xi \rightarrow \xi_0$ and $\xi \rightarrow \xi_1$, respectively.

Fig. 6.2 encodes the structure of singularities of F_0 on \mathcal{R}_Ξ in the following way. A given class $\gamma \in \mathcal{R}_\Xi$ can be represented by a curve composed of rays and arcs of circle. In Fig. 6.2, in the F_0 -plane, this corresponds to a curve γ' composed of constant phase (dark gray) lines or constant modulus (light gray) lines. Curves in \mathcal{R}_Ξ terminating at singularities of F_0 correspond in Fig. 6.1. to curves so that $|F_0| \rightarrow \infty$ (the four dark gray separatrices S_1, \dots, S_4). Thus to calculate, on a particular Riemann sheet of \mathcal{R}_Ξ , where F_0 is singular, one needs to find the limit of ξ in (6.32), as $F_0 \rightarrow \infty$ along γ' followed by S_i . This is straightforward, since the branch of the complex powers $\theta, \bar{\theta}$, is calculated easily from the index of γ' with respect to P_\pm .

Remark 6.34 can now be applied on relatively compact subdomains of \mathcal{R}_Ξ and used to determine a uniform asymptotic representation $y \sim \tilde{y}$ in domains surrounding singularities of $y(x)$, and to obtain their asymptotic location. Going back to the original variables, similar information on $u(z)$ follows.

Applying Remark 6.34 to (5.58) it follows that for $n \rightarrow \infty$, a given solution y is singular at points $\tilde{x}_{p,n}$ such that $\xi(\tilde{x}_{p,n})/\xi_p = 1 + o(1)$ ($|\tilde{x}_{p,n}|$ large).

Now, y can only be singular if $|y| \rightarrow \infty$ (otherwise the right side of (5.58) is analytic). If $\tilde{x}_{p,n}$ is a point where y is unbounded, with $\delta = x - \tilde{x}_{p,n}$ and $v = 1/y$ we have

$$\frac{d\delta}{dv} = vF_s(v, \delta) \tag{6.38}$$

where F_s is analytic near $(0, 0)$. It is easy to see that this differential equation has a unique solution with $\delta(0) = 0$ and that $\delta'(0) = 0$ as well.

The result is then that the singularities of u are also algebraic of order $-1/2$.

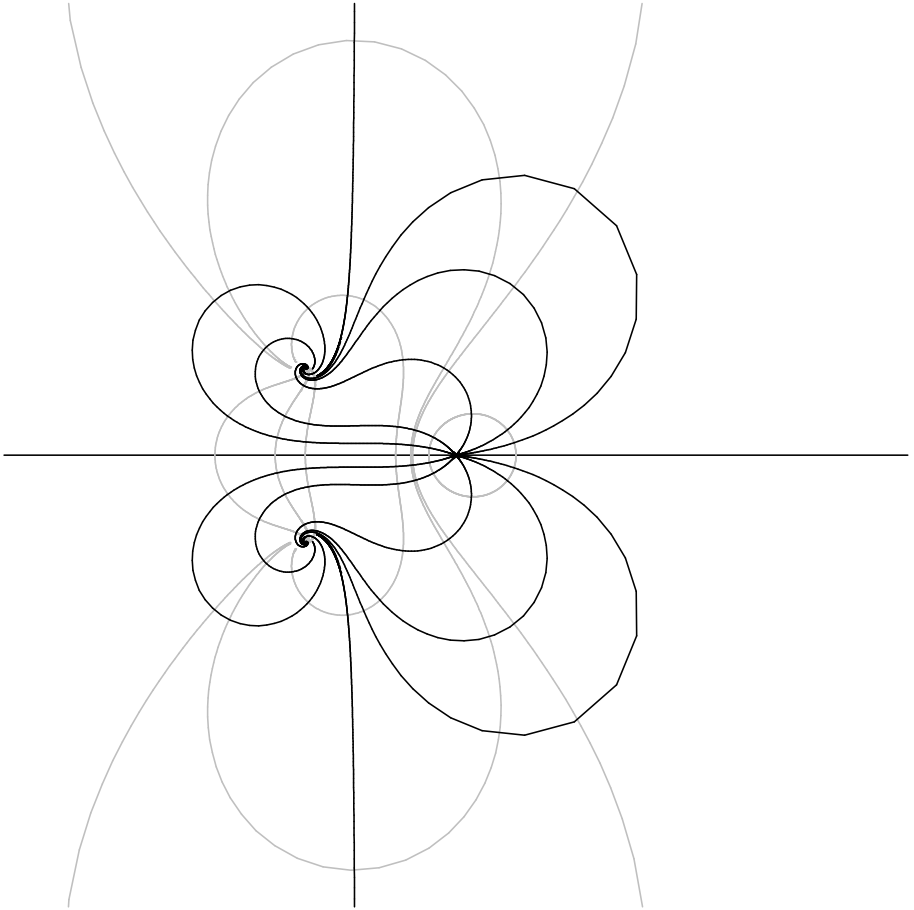

FIGURE 6.2: The dark lines represent the phase portrait of (6.37), as well as the lines of steepest variation of $|\xi(u)|$. The light gray lines correspond to the orthogonal field, and to the lines $|\xi(u)| = \text{const}$.

Proposition 6.39 *If z_0 is a singularity of $u(z; C_+)$, then in a neighborhood of z_0 we have*

$$u = \pm \sqrt{-1/2}(z - z_0)^{-1/2} A_0((z - z_0)^{1/2}) \tag{6.40}$$

where A_0 is analytic at zero and $A_0(0) = 1$.

Notes. 1. The local behavior near a singularity could have been guessed by local Painlevé analysis and the method of dominant balance, with the standard ansatz near a singularity, $u \sim Const.(z - z_0)^p$. The results here are **global**: Proposition 6.28 gives the behavior of a *fixed* solution at infinitely many singularities, and gives the **position** of these singularities as soon as C_+ (or the position of only one of these singularities) is known (and in addition show that the power behavior ansatz is correct in this case).

2. By the substitution $y = v/(1 + v)$ in (5.58) we get

$$v' = -v - 27 \frac{v^3}{1 + v} - 10v^2 + \frac{1}{5t}v + g^{[1]}(t^{-1}, v) \tag{6.41}$$

The singularities of v are at the points where $v(t) = -1$.

3. **It is not always the case** that the singularities of y must be of the same *type* as the singularities of F_0 . The position, as we argued is asymptotically the same, but near singularities the expansion (6.13) becomes invalid and it must either be re-matched to an expansion valid near singularities or, again, we can rely on the differential equation to see what these singularities are.

Further examples and discussions follow, in §6.6a and §6.6b.

6.5 General case

The setting is that of (5.51) after normalization, and with the assumptions of §5.4 and §5.6. The region where the formal or summed transseries is valid is

$$\{x \in \mathbb{C}; \text{ if } C_j \neq 0, \text{ then } x^{\alpha_j} e^{-\lambda_j x} = o(1), j = 1, \dots, n\} \tag{6.42}$$

see also (c1) of §5.6b. Singularities are formed near the curves where condition (c1) fails. Without loss of generality, we assume that, on one side of the region, say the upper one, (c1) is violated first because of $\lambda_1 = 1$. This means the constants C_i are chosen so that the transseries contains *no eigenvalue in the first quadrant*, and the region (6.42) goes up roughly up to $i\mathbb{R}^+$. We let

$$S_t = S_t(\mathbf{y}(x); \epsilon) = \left\{ x; |x| > R, \arg(x) \in \left[-\frac{\pi}{2} \pm \epsilon, \frac{\pi}{2} \pm \epsilon\right] \text{ and } |(\mathbf{C}_\pm)_j e^{-\lambda_j x} x^{\alpha_j}| < \delta^{-1} \text{ for } j = 1, \dots, n \right\} \tag{6.43}$$

This is a nearly maximal region, allowing for Stokes transitions, where the transseries of a given solution \mathbf{y} which is $o(1)$ at $+\infty$ is an asymptotic representation of \mathbf{y} . It will turn out that, in fact, only the constant C_1 intervenes in singularity formation near the upper edge of S_t . The Stokes transitions in \mathbb{C} due to eigenvalues in the fourth quadrant are thus irrelevant to the convergence of the transseries, and do not appear in the definition of S_t .

6.5a Notation and further assumptions

Consider a solution $\mathbf{y}(x)$ of (5.289) satisfying the assumptions in §5.6 and §5.6a and those at the beginning of §6.5.

We use the representation of \mathbf{y} as summation of its transseries $\tilde{\mathbf{y}}(x)$ (5.64) in the direction d . Let

$$p_{j;\mathbf{k}} = \lambda_j - \mathbf{k} \cdot \boldsymbol{\lambda}, \quad j = 1, \dots, n_1, \quad \mathbf{k} \in \mathbb{Z}_+^{n_1} \tag{6.44}$$

For simplicity we *assume*, what is generically the case, that no $\overline{p_{j;\mathbf{k}}}$ lies on the antistokes lines bounding S_t .

We *assume* that not all parameters C_j are zero, say $C_1 \neq 0$. Then S_t is bounded by two antistokes lines and its opening is at most π .

We arrange that

(a) $\arg(\lambda_1) < \arg(\lambda_2) < \dots < \arg(\lambda_{n_1})$

and, by construction,

(b) $\text{Im } \lambda_k \geq 0$.

The solution $\mathbf{y}(x)$ is then analytic in a region S_t .

Since we analyze the upper boundary of S_t , the constant \mathbf{C}_+ is the relevant one.

Note. Once again, to simplify notation, we drop the subscript “+” and write $\mathbf{C}_+ = \mathbf{C}$.

We use Theorem 5.79 to write the solution in the first quadrant as

$$\mathbf{y}(x) = \sum_{\mathbf{k} \geq 0} \mathbf{C}^{\mathbf{k}} e^{-\boldsymbol{\lambda} \cdot \mathbf{k} x} x^{\mathbf{k} \cdot \boldsymbol{\alpha}} \mathbf{y}_{\mathbf{k}}(x) = \sum_{\mathbf{k} \geq 0} \mathbf{C}^{\mathbf{k}} e^{-\boldsymbol{\lambda} \cdot \mathbf{k} x} x^{\mathbf{k} \cdot \boldsymbol{\alpha}} \mathcal{L} \mathcal{B} \tilde{\mathbf{y}}_{\mathbf{k}}(x) \equiv \mathcal{L} \mathcal{B} \tilde{\mathbf{y}}(x) \tag{6.45}$$

All terms in (6.45) with \mathbf{k} not a multiple of $\mathbf{e}_1 = (1, 0, \dots, 0)$ are subdominant (small) near the upper edge of S_t . Thus, for x near $i\mathbb{R}^+$ we only need to look at the particular family of solutions

$$\mathbf{y}^{[1]}(x) = \sum_{k \geq 0} C_1^k e^{-kx} x^{k\alpha_1} \mathbf{y}_{k\mathbf{e}_1}(x) \tag{6.46}$$

As in the first order example analyzed before, the region of convergence of (6.46) (thus of (6.45)) is determined by the effective variable $\xi = C_1 e^{-x} x^{\alpha_1}$ (since $\mathbf{y}_{k\mathbf{e}_1} \sim \tilde{\mathbf{y}}_{k\mathbf{e}_1;0} / x^{k(\alpha_1 - M_1)}$). As in the simple examples at the beginning

of the chapter, the leading behavior of $\mathbf{y}^{[1]}$ near the upper boundary of S_t is expected to be

$$\mathbf{y}^{[1]}(x) \sim \sum_{k \geq 0} (C_1 e^{-x} x^{\alpha_1})^k \tilde{\mathbf{s}}_{k\mathbf{e}_1;0} \equiv \mathbf{F}_0(\xi) \tag{6.47}$$

Taking into account all terms in $\tilde{\mathbf{s}}_{k\mathbf{e}_1}$, $k \geq 0$, we get

$$\mathbf{y}^{[1]}(x) \sim \sum_{r=0}^{\infty} x^{-r} \sum_{k=0}^{\infty} \xi^k \tilde{\mathbf{y}}_{k\mathbf{e}_1;r} \equiv \sum_{j=0}^{\infty} \frac{\mathbf{F}_j(\xi)}{x^j} \tag{6.48}$$

Denote

$$\xi = \xi(x) = C_1 e^{-x} x^{\alpha_1} \tag{6.49}$$

Fix some small, positive δ and c and let

$$\mathcal{E} = \left\{ x ; \arg(x) \in \left[-\frac{\pi}{2} + \delta, \frac{\pi}{2} + \delta \right] \text{ and } \operatorname{Re}(\lambda_j x / |x|) > c \text{ for all } j \text{ with } 2 \leq j \leq n_1 \right\} \tag{6.50}$$

Also let

$$\mathcal{S}_{\delta_1} = \{ x \in \mathcal{E} ; |\xi(x)| < \delta_1 \} \tag{6.51}$$

It is easy to see that, since \mathbf{g} is $O(x^{-2})$, then so is $\tilde{\mathbf{y}}_0$. This implies that $\mathbf{F}_0(0) = 0$. Both \mathbf{F}_0 and \mathbf{y} will turn out to be analytic in \mathcal{S}_{δ_1} ; the interesting region is then $\mathcal{E} \setminus \mathcal{S}_{\delta_1}$ (containing the light grey region in Figure 6.1).

The sector \mathcal{E} contains S_t , except for a thin sector at the lower edge of S_t (excluded by the conditions $\operatorname{Re}(\lambda_j x / |x|) > c$ for $2 \leq j \leq n_1$, or, if $n_1 = 1$, by the condition $\arg(x) \geq -\frac{\pi}{2} + \delta$), and may extend beyond $i\mathbb{R}_+$ since there is no condition on $\operatorname{Re}(\lambda_1 x)$ —hence $\operatorname{Re}(\lambda_1 x) = \operatorname{Re}(x)$ may change sign in \mathcal{E} and \mathcal{S}_{δ_1} .

Figure 6.3 p. 229 is drawn for $n_1 = 1$; \mathcal{E} contains the gray regions and extends beyond the curved boundary.

Let Ξ be a finite set (possibly empty) of points in the ξ -plane. This set will consist of singular points of \mathbf{F}_0 thus we assume $\operatorname{dist}(\Xi, 0) \geq \delta_1$.

Denote by \mathcal{R}_{Ξ} the Riemann surface above $\mathbb{C} \setminus \Xi$. More precisely, we assume that \mathcal{R}_{Ξ} is realized as equivalence classes of simple curves $\Gamma : [0, 1] \mapsto \mathbb{C}$ with $\Gamma(0) = 0$ modulo homotopies in $\mathbb{C} \setminus \Xi$.

Let $\mathcal{D} \subset \mathcal{R}_{\Xi}$ be open, relatively compact, and connected, with the following properties:

- (1) $\mathbf{F}_0(\xi)$ is analytic in an $\epsilon_{\mathcal{D}}$ -neighborhood of \mathcal{D} with $\epsilon_{\mathcal{D}} > 0$,
- (2) $\sup_{\mathcal{D}} |\mathbf{F}_0(\xi)| := \rho_3$ with $\rho_3 < \rho_2$
- (3) \mathcal{D} contains $\{ \xi : |\xi| < \delta_1 \}$.⁴

⁴Conditions (2),(3) can be typically satisfied since $\mathbf{F}_0(\xi) = \xi + O(\xi^2)$ and $\delta_1 < \rho_2$ (see also the examples in §6.6); borderline cases may be treated after choosing a smaller δ_1 .

It is assumed that there is an upper bound on the length of the curves joining points in \mathcal{D} : $d_{\mathcal{D}} = \sup_{a,b \in \mathcal{D}} \inf_{\Gamma \subset \mathcal{D}; a,b \in \Gamma} \text{length}(\Gamma) < \infty$.

We also need the x -plane counterpart of this domain.

Let $R > 0$ (large) and let $X = \xi^{-1}(\Xi) \cap \{x \in \mathcal{E} : |x| > R\}$.

Let Γ be a curve in \mathcal{D} . There is a countable family of curves γ_N in the x -plane with $\xi(\gamma_N) = \Gamma$. The curves are smooth for $|x|$ large enough and satisfy

$$\gamma_N(t) = 2N\pi i + \alpha_1 \ln(2\pi i N) - \ln \Gamma(t) + \ln C_1 + o(1) \quad (N \rightarrow \infty) \quad (6.52)$$

(For a proof see Appendix of [24].)

To preserve smoothness, we will restrict to $|x| > R$ with R large enough, so that along (a smooth representative of) each $\Gamma \in \mathcal{D}$, the branches of ξ^{-1} are analytic.

If the curve Γ is a smooth representative in \mathcal{D} we then have $\xi^{-1}(\Gamma) = \cup_{N \in \mathbb{N}} \gamma_N$ where γ_N are smooth curves in $\{x : |x| > 2R\} \setminus X$.

Definition. We define \mathcal{D}_x as the equivalence classes modulo homotopies in $\{x \in \mathcal{E} : |x| > R\} \setminus X$ (with ∞ fixed point) of those curves γ_N which are completely contained in $\mathcal{E} \cap \{x : |x| > 2R\}$.

6.5b The recursive system for the \mathbf{F}_m s

The functions \mathbf{F}_m are determined recursively, from their differential equation. Formally the calculation is the following.

The series $\tilde{\mathbf{F}} = \sum_{m \geq 0} x^{-m} \mathbf{F}_m(\xi)$ is a formal solution of (5.289); substitution in the equation and identification of coefficients of x^{-m} yields the recursive system

$$\frac{d}{d\xi} \mathbf{F}_0 = \xi^{-1} \left(\hat{\Lambda} \mathbf{F}_0 - \mathbf{g}(0, \mathbf{F}_0) \right) \quad (6.53)$$

$$\frac{d}{d\xi} \mathbf{F}_m + \hat{N} \mathbf{F}_m = \alpha_1 \frac{d}{d\xi} \mathbf{F}_{m-1} + \mathbf{R}_{m-1} \quad \text{for } m \geq 1 \quad (6.54)$$

where \hat{N} is the matrix

$$\xi^{-1}(\partial_{\mathbf{y}} \mathbf{g}(0, \mathbf{F}_0) - \hat{\Lambda}) \quad (6.55)$$

and the function $\mathbf{R}_{m-1}(\xi)$ depends only on the \mathbf{F}_k with $k < m$:

$$\xi \mathbf{R}_{m-1} = - \left[(m-1)I + \hat{A} \right] \mathbf{F}_{m-1} - \frac{1}{m!} \frac{d^m}{dz^m} \mathbf{g} \left(z; \sum_{j=0}^{m-1} z^j \mathbf{F}_j \right) \Bigg|_{z=0} \quad (6.56)$$

For more detail see [24] Section 4.3.

To leading order we have $\mathbf{y} \sim \mathbf{y}^{[1]} \sim \mathbf{F}_0$ where \mathbf{F}_0 satisfies the autonomous (after a substitution $\xi = e^\zeta$) equation

$$\mathbf{F}'_0 = \hat{\Lambda}\mathbf{F}_0 - \mathbf{g}(0, \mathbf{F}_0)$$

which can be solved in closed form for first order equations scalar equations (the equation for F_0 is separable, and for $k \geq 1$ the equations are linear), as well as in other interesting cases (see e.g. §6.6b).

To determine the \mathbf{F}_m s associated to \mathbf{y} we first note that these functions are analytic at $\xi = 0$ (cf. Theorem 6.57). Denoting by $F_{m,j}$, $j = 1, \dots, n$ the components of \mathbf{F}_m , a simple calculation shows that (6.53) has a unique analytic solution satisfying $F_{0,1}(\xi) = \xi + O(\xi^2)$ and $F_{0,j}(\xi) = O(\xi^2)$ for $j = 2, \dots, n$. For $m = 1$, there is a one parameter family of solutions of (6.54) having a Taylor series at $\xi = 0$, and they have the form $F_{1,1}(\xi) = c_1\xi + O(\xi^2)$ and $F_{1,j}(\xi) = O(\xi^2)$ for $j = 2, \dots, n$. The condition that (6.54) has an analytic solution for $m = 2$ turns out to determine c_1 . For this value of c_1 there is a one-parameter family of solutions \mathbf{F}_2 analytic at $\xi = 0$ and this new parameter is determined by analyzing the equation of \mathbf{F}_3 . The procedure can be continued to any order in m , in the same way; in particular, the constant c_m is only determined at step $m + 1$ from the condition of analyticity of \mathbf{F}_{m+1} . Compare with §6.6a.

6.5c General results and properties of the functions \mathbf{F}_m

We describe in detail the results but omit many proofs, given in [24] which roughly follow the lines sketched in §6.1, but are rather lengthy.

The locations of singularities of $\mathbf{y}(x)$ depend on the constant C_1 (constant which may change when we cross the Stokes ray \mathbb{R}^+). We need its value in the sector between \mathbb{R}^+ and $i\mathbb{R}_+$, the next Stokes ray.

Theorem 6.57 (i) *The functions $\mathbf{F}_m(\xi)$; $m \geq 1$, are analytic in \mathcal{D} (note that by construction \mathbf{F}_0 is analytic in \mathcal{D}) and for some positive B, K_1 we have*

$$|F_m(\xi)| \leq K_1 m! B^m, \quad \xi \in \mathcal{D} \tag{6.58}$$

(ii) *For large enough R , the solution $\mathbf{y}(x)$ is analytic in \mathcal{D}_x and has the asymptotic representation*

$$\mathbf{y}(x) \sim \sum_{m=0}^{\infty} x^{-m} \mathbf{F}_m(\xi(x)) \quad (x \in \mathcal{D}_x, |x| \rightarrow \infty) \tag{6.59}$$

In fact, the following Gevrey-like estimates hold

$$\left| \mathbf{y}(x) - \sum_{j=0}^{m-1} x^{-j} \mathbf{F}_j(\xi(x)) \right| \leq K_2 m! B_2^m |x|^{-m} \quad (m \in \mathbb{N}^+, x \in \mathcal{D}_x) \quad (6.60)$$

(iii) Assume \mathbf{F}_0 has an isolated singularity at $\xi_s \in \Xi$ and that the projection of \mathcal{D} on \mathbb{C} contains a punctured neighborhood of (or an annulus of inner radius r around) ξ_s .

Then, if $C_1 \neq 0$, $\mathbf{y}(x)$ is singular at a distance at most $o(1)$ ($r + o(1)$, respectively) of $x_n \in \xi^{-1}(\{\xi_s\}) \cap \mathcal{D}_x$, as $x_n \rightarrow \infty$.

The collection $\{x_n\}_{n \in \mathbb{N}}$ forms a nearly periodic array

$$x_n = 2n\pi i + \alpha_1 \ln(2n\pi i) + \ln C_1 - \ln \xi_s + o(1) \quad (6.61)$$

as $n \rightarrow \infty$.

Remarks. 1. The singularities x_n satisfy $C_1 e^{-x_n} x_n^{\alpha_1} = \xi_s(1 + o(1))$ (for $n \rightarrow \infty$). Therefore, the singularity array lies slightly to the left of the anti-stokes line $i\mathbb{R}_+$ if $\text{Re}(\alpha_1) < 0$ (this case is depicted in Fig. 6.3), p. 229 and slightly to the right of $i\mathbb{R}_+$ if $\text{Re}(\alpha_1) > 0$.

2. To find singularities in the solutions of the system (5.51) we need to find the normalization that gives an α_1 is as **small** as possible, undoing the transformations described in (n4) on p. 156, which serve the different purpose of unifying the treatment of generic ODEs. Enlarging α , always possible, yields an \mathbf{F}_0 which is entire, and manifest singularity information is lost. See also the comments on p. 232.

3. By (6.60) a truncation of the two-scale series (6.59) at an m dependent on x ($m \sim |x|/B$) is seen to produce exponential accuracy $o(e^{-|x|/B})$; see e.g. [5].

4. Theorem 6.57 can also be used to determine precisely the nature of the singularities of $\mathbf{y}(x)$. In effect, for any n , the representation (6.59) provides $o(e^{-K|x_n|})$ estimates on \mathbf{y} down to an $o(e^{-K|x_n|})$ distance of an actual singularity x_n . In most instances this is more than sufficient to match to a suitable local integral equation, contractive in a tiny neighborhood of x_n , providing rigorous control of the singularity. See also §6.6.

6.6 Further examples

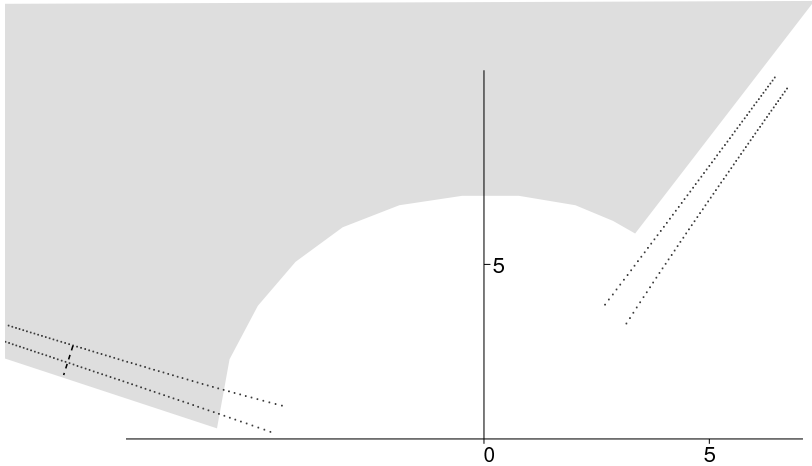

FIGURE 6.3: Singularities on the boundary of S_t for (5.52). The gray region lies in the projection on \mathbb{C} of the Riemann surface where (6.29) holds. The short dotted line is a generic cut delimiting a first Riemann sheet.

6.6a The Painlevé equation P_I

Proposition 6.62 below shows, in (i), how the constant C beyond all orders is associated to a truncated solution $y(z)$ of P_I for $\arg(z) = \pi$ (formula (6.63)) and gives the position of one array of poles z_n of the solution associated to C (formula (6.64)), and in (ii) provides uniform asymptotic expansion to all orders of this solution in a sector centered on $\arg(z) = \pi$ and one array of poles (except for small neighborhoods of these poles) in formula (6.66).

Proposition 6.62 (i) *Let y be a solution of (4.81) such that $y(z) \sim \sqrt{-z/6}$ for large z with $\arg(z) = \pi$. For any $\phi \in (\pi, \pi + \frac{2}{3}\pi)$ the following limit*

determines the constant C (which does not depend on ϕ in this range) in the transseries \tilde{y} of y :

$$\lim_{\substack{|z| \rightarrow \infty \\ \arg(z) = \phi}} \xi(z)^{-1} \left(\sqrt{\frac{6}{-z}} y(z) - \sum_{k \leq |x(z)|} \frac{\tilde{y}_{0;k}}{z^{5k/2}} \right) = C \tag{6.63}$$

(Note that the constants $\tilde{y}_{0;k}$ do not depend on C). With this definition, if $C \neq 0$, the function y has poles near the antistokes line $\arg(z) = \pi + \frac{2}{5}\pi$ at all points z_n , where, for large n

$$z_n = -\frac{(60\pi i)^{4/5}}{24} \left(n^{\frac{4}{5}} + iL_n n^{-\frac{1}{5}} + \left(\frac{L_n^2}{8} - \frac{L_n}{4\pi} + \frac{109}{600\pi^2} \right) n^{-\frac{6}{5}} \right) + O\left(\frac{(\ln n)^3}{n^{\frac{11}{5}}}\right) \tag{6.64}$$

with $L_n = \frac{1}{5\pi} \ln\left(\frac{\pi i C^2}{72} n\right)$, or, more compactly,

$$\xi(z_n) = 12 + \frac{327}{(-24z_n)^{5/4}} + O(z_n^{-5/2}) \quad (z_n \rightarrow \infty) \tag{6.65}$$

(ii) Let $\epsilon \in \mathbb{R}^+$ and define

$$\mathcal{Z} = \{z : \arg(z) > \frac{3}{5}\pi; |\xi(z)| < 1/\epsilon; |\xi(z) - 12| > \epsilon\}$$

(the region starts at the antistokes line $\arg(z) = \frac{3}{5}\pi$ and extends slightly beyond the next antistokes line, $\arg(z) = \frac{7}{5}\pi$). If $y \sim \sqrt{-z/6}$ as $|z| \rightarrow \infty$, $\arg(z) = \pi$, then for $z \in \mathcal{Z}$ we have

$$y \sim \sqrt{\frac{-z}{6}} \left(1 - \frac{1}{8\sqrt{6}(-z)^{5/2}} + \sum_{k=0}^{\infty} \frac{30^k H_k(\xi)}{(-24z)^{5k/4}} \right) \quad (|z| \rightarrow \infty, z \in \mathcal{Z}) \tag{6.66}$$

The functions H_k are rational, and $H_0(\xi) = \xi(\xi/12 - 1)^{-2}$. The expansion (6.66) holds uniformly in the sector $\pi^{-1} \arg(z) \in (3/5, 7/5)$ and also on one of its sides, where H_0 becomes dominant, down to an $o(1)$ distance of the actual poles of y if z is large.

Proof. We prove the corresponding statements for the normal form (4.85). One returns to the variables of (4.81) by simple substitutions, which we omit.

Most of Proposition 6.62 is a direct consequence of Theorems 1 and 2. For the one-parameter family of solutions which are small in \mathbb{H} we then have

$$h \sim \sum_{k=0}^{\infty} x^{-k} H_k(\xi(x)) \quad (6.67)$$

where $\xi(x) = x^{-1/2} e^{-x}$ (thus $\alpha = -1/2$).

As in the first example we find H_k by substituting (6.67) in (4.85).

The equation of H_0 is

$$\xi^2 H_0'' + \xi H_0' = H_0 + \frac{1}{2} H_0^2$$

The general solution of this equation is a Weierstrass elliptic function of $\ln \xi$, as expected from the general knowledge of the asymptotic behavior of the Painlevé solutions (see [39]). For our special initial condition, H_0 analytic at zero and $H_0(\xi) = \xi(1 + o(1))$, the solution is a degenerate elliptic function, namely,

$$H_0(\xi) = \frac{\xi}{(\xi/12 - 1)^2}$$

Important remark. *One of the two free constants in the general solution H_1 is determined by the condition of analyticity at zero of H_1 (this constant multiplies terms in $\ln \xi$). It is interesting to note that the remaining constant is only determined in the next step, when solving the equation for H_2 ! This pattern is typical (see §6.5b).*

Continuing this procedure, we obtain successively:

$$H_1 = \left(216 \xi + 210 \xi^2 + 3 \xi^3 - \frac{1}{60} \xi^4 \right) (\xi - 12)^{-3} \quad (6.68)$$

$$H_2 = \left(1458 \xi + 5238 \xi^2 - \frac{99}{8} \xi^3 - \frac{211}{30} \xi^4 + \frac{13}{288} \xi^5 + \frac{\xi^6}{21600} \right) (\xi - 12)^{-4} \quad (6.69)$$

We omit the straightforward but quite lengthy inductive proof that all H_k are rational functions of ξ . The reason the calculation is tedious is that this property holds for (4.85) but *not* for its generic perturbations, and the last potential obstruction to rationality, successfully overcome by (4.85), is at $k = 6$. On the positive side, these calculations are algorithmic and are very easy to carry out with the aid of a symbolic language program.

In the same way as in Example 1 one can show that the corresponding singularities of h are double poles: all the terms of the corresponding asymptotic expansion of $1/h$ are *analytic* near the singularity of h ! All this is again straightforward (but lengthy because of the potential obstruction at $k = 6$).

Let ξ_s correspond to a zero of $1/h$. To leading order, $\xi_s = 12$, by Theorem 6.57 (iii). To find the next order in the expansion of ξ_s , one substitutes $\xi_s = 12 + A/x + O(x^{-2})$ to obtain

$$1/h(\xi_s) = \frac{(A - 109/10)^2}{12^3 x^2} + O(1/x^3)$$

whence $A = 109/10$ (because $1/h$ is analytic at ξ_s) and we have

$$\xi_s = 12 + \frac{109}{10x} + O(x^{-2}) \tag{6.70}$$

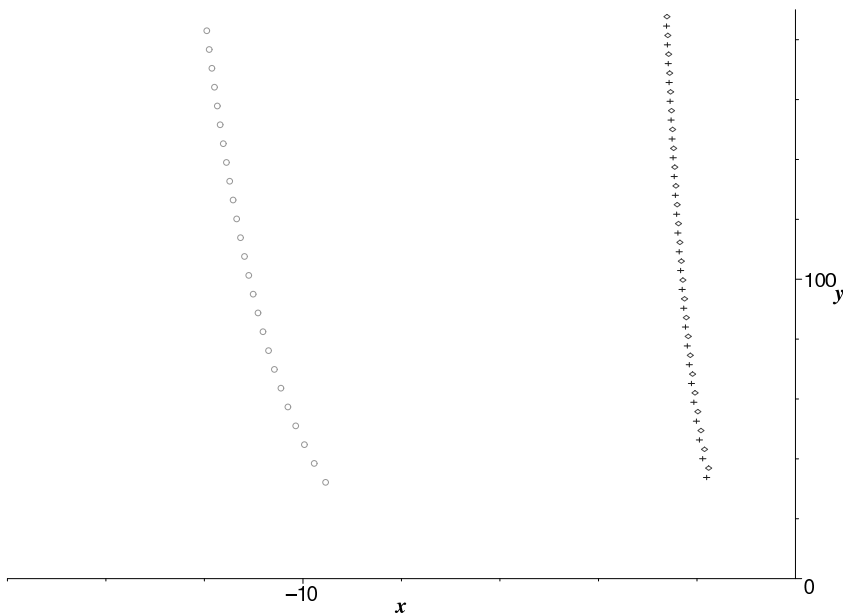

FIGURE 6.4: Poles of (4.85) for $C = -12$ (\diamond) and $C = 12$ ($+$), calculated via (6.70). The light circles are on the second line of poles for to $C = -12$.

Given a solution h , its constant C in ξ for which (6.67) holds can be calculated from asymptotic information in any direction above the real line by near least term truncation, namely

$$C = \lim_{\substack{x \rightarrow \infty \\ \arg(x) = \phi}} \exp(x)x^{1/2} \left(h(x) - \sum_{k \leq |x|} \frac{\tilde{h}_{0,k}}{x^k} \right) \tag{6.71}$$

(this is a particular case of much more general formulas [19] where $\sum_{k>0} \tilde{h}_{0,k} x^{-k}$ is the common asymptotic series of all solutions of (4.85) which are small in \mathbb{H} . □

General comments. The expansion scales, x and $x^{-1/2}e^{-x}$, are crucial. Only for this choice one obtains an expansion which is valid both in S_t and near poles of (4.85). For instance, the more general second scale $x^a e^{-x}$ introduces logarithmic singularities in H_j , except when $a \in -\frac{1}{2} + \mathbb{Z}$. With these logarithmic terms, the two-scale expansion would only be valid in an $O(1)$ region in x , what is sometimes called a “patch at infinity,” instead of more than a sector. Also, $a \in -\frac{1}{2} - \mathbb{N}^+$ introduces obligatory singularities at $\xi = 0$ precluding the validity of the expansion in S_t . The case $a \in -\frac{1}{2} + \mathbb{N}^+$ produces instead an expansion valid in S_t but not near poles. Indeed, the substitution $h(x) = g(x)/x^n$, $n \in \mathbb{N}$ has the effect of changing α to $\alpha + n$ in the normal form. This in turn amounts to restricting the analysis to a region far away from the poles, and then all H_j will be entire. In general we need thus to make (by substitutions in (5.289)) $a = \alpha$ minimal compatible with the assumptions (a1) and (a2), as this ensures the widest region of analysis.

6.6b The Painlevé equation P_{II}

This equation reads:

$$y'' = 2y^3 + xy + \gamma \tag{6.72}$$

Working again as in §5.5, after the change of variables

$$x = (3t/2)^{2/3}; \quad y(x) = x^{-1}(t h(t) - \gamma)$$

one obtains the normal form equation

$$h'' + \frac{h'}{t} - \left(1 + \frac{24\gamma^2 + 1}{9t^2}\right) h - \frac{8}{9}h^3 + \frac{8\gamma}{3t}h^2 + \frac{8(\gamma^3 - \gamma)}{9t^3} = 0 \tag{6.73}$$

and

$$\lambda_1 = 1, \quad \alpha_1 = -1/2; \quad \xi = \frac{e^{-t}}{\sqrt{t}}; \quad \xi^2 F_0'' + \xi F_0' = F_0 + \frac{8}{9}F_0^3$$

The initial condition is (always): F_0 analytic at 0 and $F_0'(0) = 1$. This implies

$$F_0(\xi) = \frac{\xi}{1 - \xi^2/9}$$

Distinct normalizations (and sets of solutions) are provided by

$$x = (At)^{2/3}; \quad y(x) = (At)^{1/3} \left(w(t) - B + \frac{\gamma}{2At} \right)$$

if $A^2 = -9/8, B^2 = -1/2$. In this case,

$$w'' + \frac{w'}{t} + w \left(1 + \frac{3B\gamma}{tA} - \frac{1 - 6\gamma^2}{9t^2} \right) w - \left(3B - \frac{3\gamma}{2tA} \right) w^2 + w^3 + \frac{1}{9t^2} (B(1 + 6\gamma^2) - t^{-1}\gamma(\gamma^2 - 4)) \tag{6.74}$$

so that

$$\lambda_1 = 1, \alpha_1 = -\frac{1}{2} - \frac{3}{2} \frac{B\gamma}{A}$$

implying

$$\xi^2 F_0'' + \xi F_0' - F_0 = 3BF_0^2 - F_0^3$$

and, with the same initial condition as above, we now have

$$F_0 = \frac{2\xi(1 + B\xi)}{\xi^2 + 2}$$

The first normalization applies for the manifold of solutions such that $y \sim -\frac{\gamma}{x}$ (for $\gamma = 0$ y is exponentially small and behaves like an Airy function) while the second one corresponds to $y \sim -B - \frac{\gamma}{2}x^{-3/2}$. The analysis can be completed as in the other examples.

Chapter 7

Other classes of problems

7.1 Difference equations

7.1a Setting

Let us now look at difference systems of equations which can be brought to the form

$$\mathbf{x}(n+1) = \hat{\Lambda} \left(I + \frac{1}{n} \hat{A} \right) \mathbf{x}(n) + \mathbf{g}(n, \mathbf{x}(n)) \quad (7.1)$$

where $\hat{\Lambda}$ and \hat{A} are constant coefficient matrices, \mathbf{g} is convergently given for small \mathbf{x} by

$$\mathbf{g}(n, \mathbf{x}) = \sum_{\mathbf{k} \in \mathbb{N}^m} \mathbf{g}_{\mathbf{k}}(n) \mathbf{x}^{\mathbf{k}} \quad (7.2)$$

with $\mathbf{g}_{\mathbf{k}}(n)$ analytic in n at infinity and

$$\mathbf{g}_{\mathbf{k}}(n) = O(n^{-2}) \text{ as } n \rightarrow \infty, \text{ if } \sum_{j=1}^m k_j \leq 1 \quad (7.3)$$

under nonresonance conditions: Let $\boldsymbol{\mu} = (\mu_1, \dots, \mu_n)$ and $\mathbf{a} = (a_1, \dots, a_n)$ where $e^{-\mu_k}$ are the eigenvalues of $\hat{\Lambda}$ and the a_k are the eigenvalues of \hat{A} . Then the nonresonance condition is

$$(\mathbf{k} \cdot \boldsymbol{\mu} = 0 \pmod{2\pi i} \text{ with } \mathbf{k} \in \mathbb{Z}^{m_1}) \Leftrightarrow \mathbf{k} = \mathbf{0}. \quad (7.4)$$

The theory of these equations is remarkably similar to that of differential equations. We consider the solutions of (7.1) which are small as n becomes large.

7.1b Transseries for difference equations

Braaksma [13] showed that the recurrences (7.1) possess l -parameter transseries solutions of the form

$$\tilde{\mathbf{x}}(n) := \sum_{\mathbf{k} \in \mathbb{N}^m} \mathbf{C}^{\mathbf{k}} e^{-\mathbf{k} \cdot \boldsymbol{\mu} n} t^{\mathbf{k} \cdot \mathbf{a}} \tilde{\mathbf{x}}_{\mathbf{k}}(n) \tag{7.5}$$

where $\tilde{\mathbf{x}}_{\mathbf{k}}(n)$ are formal power series in powers of n^{-1} and $l \leq m$ is chosen such that, after reordering the indices, we have $\text{Re}(\mu_j) > 0$ for $1 \leq j \leq l$.

It is shown in [13] that

$\mathbf{X}_{\mathbf{k}} = \mathcal{B}\tilde{\mathbf{x}}_{\mathbf{k}}$ are analytic in a sectorial neighborhood \mathcal{S} of \mathbb{R}^+ , and

$$\sup_{p \in \mathcal{S}, \mathbf{k} \in \mathbb{N}^m} \left| A^{|\mathbf{k}|} e^{-\nu|p|} \mathbf{X}_{\mathbf{k}} \right| < \infty \tag{7.6}$$

Furthermore, the functions $\mathbf{x}_{\mathbf{k}}$ defined by

$$\mathbf{x}_{\mathbf{k}}(n) = \int_0^\infty e^{-np} \mathbf{X}_{\mathbf{k}}(p) dp \tag{7.7}$$

are asymptotic to the series $\tilde{\mathbf{x}}_{\mathbf{k}}$, i.e.,

$$\mathbf{x}_{\mathbf{k}}(n) \sim \tilde{\mathbf{x}}_{\mathbf{k}}(n) \quad (n \rightarrow +\infty) \tag{7.8}$$

and in any direction different from a Stokes one,

$$\mathbf{x}(n) = \sum_{\mathbf{k} \in \mathbb{N}^l} \mathbf{C}^{\mathbf{k}} e^{-\mathbf{k} \cdot \boldsymbol{\mu} n} n^{\mathbf{k} \cdot \mathbf{a}} \mathbf{x}_{\mathbf{k}}(n) \tag{7.9}$$

is a solution of (7.1), if $n > y_0$, t_0 large enough.

There is a freedom of composition with periodic functions. For example, the general solution of $x_{n+1} = x_n$ is an arbitrary 1-periodic function. This freedom permeates both the formal and analytic theory. It can be ruled out by disallowing purely oscillatory terms in the transseries.

Details and many more interesting results are given in [13].

7.1c Application: Extension of solutions y_n of difference equations to the complex n plane

If the formal series solution, say in $1/n$, of a difference equation is Borel summable, then the expression (7.7) of the Borel sum allows for continuation in the complex domain. Since Borel summation preserves relations, the continuation in \mathbb{C} will as well. This remark extends to transseries. Furthermore, the complex plane continuation is unique, in the following sense: the values of \mathbf{x} on the integers uniquely determine \mathbf{x} (see [Theorem 7.1](#)). It is then easy to check that condition (7.6) implies that the sum

$$\mathbf{x}(t) = \sum_{\mathbf{k} \in \mathbb{N}^{n_0}} \mathbf{C}^{\mathbf{k}} e^{-\mathbf{k} \cdot \boldsymbol{\mu} t} t^{\mathbf{k} \cdot \mathbf{a}} \mathbf{x}_{\mathbf{k}}(t) \tag{7.10}$$

is convergent in the half-plane $\mathbb{H} = \{t : \text{Re}(t) > t_0\}$, for t_0 large enough.

Definition 7.11 Define the continuation of $\mathbf{x}_k(n)$ in the half-plane $\{t : \operatorname{Re}(t) > t_0\}$ by $\mathbf{x}(t)$ by (7.10).

THEOREM 7.1

The following uniqueness property holds. If in the assumptions (7.6)–(7.9) we have $\mathbf{x}(n) = 0$ for all except possibly finitely many $n \in \mathbb{N}$, then $\mathbf{x}(t) = 0$ for all $t \in \mathbb{C}$, $\operatorname{Re}(t) > t_0$.

For a proof, see [18]. In particular, as it is easy to see, the formal expansion of $\ln \Gamma(n)$ turns out to be exactly the extension of $\ln \Gamma$ in \mathbb{C} ; see (4.61).

This extension, in turn, and transasymptotic matching, can be used to check the Painlevé property in difference equations, and determine their integrability properties.

7.1d Extension of the Painlevé criterion to difference equations

The function \mathbf{x} is analytic in \mathbb{H} and has, in general, nontrivial singularities in $\mathbb{C} \setminus \mathbb{H}$. In particular, Painlevé's test of integrability, absence of movable non-isolated singularities, extends then to difference equations. The representation (7.10) and Theorem 7.1 make the following definition natural. As in the case of differential equations, fixed singularities are singular points whose location is the same for all solutions; they define a common Riemann surface. Other singularities (i.e., whose location depends on initial data) are called *movable*.

Definition 7.12 A difference equation has the Painlevé property if its solutions are analyzable and their analytic continuations on a Riemann surface, common to all solutions, have only isolated singularities.

For instance, the Gamma function satisfies the Painlevé criterion, as seen in (4.127). But the solution of an equation as simple as the logistic equation $x_{n+1} = ax_n(1 - x_n)$ fails the criterion, except in the known integrable cases $a = -2, 0, 2, 4$, [18].

7.2 PDEs

Borel summability has been developed substantially in PDE settings as well. It comes as a particularly useful tool in nonlinear PDEs, since, unlike in ODEs, existence and uniqueness of solutions are not known in general. Wherever applicable, Borel summation provides actual solutions by simply summing formal ones most often much more easily accessible.

These formal solutions exist only if the initial conditions are smooth enough. This cannot be assumed in general, and in this context it is useful to reinterpret Borel summation as a regularization tool. When solutions corresponding to analytic initial data are Borel summable, it means that the Borel transformed equation, which has the Borel sums as solutions must be more regular. Indeed, Borel transforms are by definition analytic, and thus the transformed equation has analytic solutions if the data is analytic, a sign of better regularity of the equation altogether.

7.2a Example: Regularizing the heat equation

$$f_{xx} - f_t = 0 \quad (7.13)$$

Since (7.13) is parabolic, power series solutions

$$f = \sum_{k=0}^{\infty} t^k F_k(x) = \sum_{k=0}^{\infty} \frac{F_0^{(2k)}}{k!} t^k \quad (7.14)$$

are divergent even if F_0 is analytic (but not entire). Nevertheless, under suitable assumptions, Borel summability results of such formal solutions have been shown by Lutz, Miyake, and Schäfke [44] and more general results of multisummability of linear PDEs have been obtained by Balsler [5].

The heat equation can be regularized by a suitable Borel transform. The divergence implied, under analyticity assumptions, by (7.14) is $F_k = O(k!)$ which indicates Borel summation with respect to t^{-1} . Indeed, the substitution

$$t = 1/\tau; \quad f(t, x) = t^{-1/2} g(\tau, x) \quad (7.15)$$

yields

$$g_{xx} + \tau^2 g_{\tau} + \frac{1}{2} \tau g = 0$$

which becomes after formal inverse Laplace transform (Borel transform) in τ ,

$$p\hat{g}_{pp} + \frac{3}{2}\hat{g}_p + \hat{g}_{xx} = 0 \quad (7.16)$$

which is brought, by the substitution $\hat{g}(p, x) = p^{-\frac{1}{2}} u(x, 2p^{\frac{1}{2}})$; $y = 2p^{\frac{1}{2}}$, to the wave equation, which is hyperbolic, thus *regular*

$$u_{xx} - u_{yy} = 0. \quad (7.17)$$

Existence and uniqueness of solutions to regular equations is guaranteed by Cauchy-Kowalevsky theory. For this simple equation the general solution is certainly available in explicit form: $u = f_1(x - y) + f_2(x + y)$ with f_1, f_2 arbitrary twice differentiable functions. Since the solution of (7.17) is related

to a solution of (7.13) through (7.15), to ensure that we do get a solution it is easy to check that we need to choose $f_1 = f_2 =: u$ (up to an irrelevant additive constant which can be absorbed into u) which yields,

$$f(t, x) = t^{-\frac{1}{2}} \int_0^\infty y^{-\frac{1}{2}} \left[u \left(x + 2y^{\frac{1}{2}} \right) + u \left(x - 2y^{\frac{1}{2}} \right) \right] \exp \left(-\frac{y}{t} \right) dy \quad (7.18)$$

which, after splitting the integral and making the substitutions $x \pm 2y^{\frac{1}{2}} = s$ is transformed into the usual Heat kernel solution,

$$f(t, x) = t^{-\frac{1}{2}} \int_{-\infty}^\infty u(s) \exp \left(-\frac{(x-s)^2}{4t} \right) ds \quad (7.19)$$

7.2b Higher order nonlinear systems of evolution PDEs

For PDEs with analytic coefficients which can be transformed to equations in which the differentiation order in a distinguished variable, say time, is no less than the one with respect to the other variable(s), under some other natural assumptions, Cauchy-Kowalevsky theory (C-K) applies and gives existence and uniqueness of the initial value problem. A number of evolution equations do not satisfy these assumptions and even if formal power series solutions exist, their radius of convergence is zero. The paper [21] provides a C-K type theory in such cases, providing existence, uniqueness and regularity of the solutions. Roughly, convergence is replaced by Borel summability, although the theory is more general.

Unlike in C-K, solutions of nonlinear evolution equations develop singularities which can be more readily studied from the local behavior near $t = 0$, and this is useful in determining and proving spontaneous blow-up. This is somewhat similar to the mechanism discussed in Chapter 6.

We describe some of the results in [21]. The proofs can be found in the paper. Roughly, the approach is similar to the ODE one. However, here the dual equation is a partial differential-convolution equation. It would superficially look like complicating the problem even further, but the built-in regularity of the new equation makes its study in fact much easier than the one of the original equation. In [21], to simplify the algebra, and in fact reduce to an almost ODE-like equation, we make use of Écalle acceleration (cf. §8.2) although the type of divergence would not require it.

In the following, $\partial_{\mathbf{x}}^{\mathbf{j}} \equiv \partial_{x_1}^{j_1} \partial_{x_2}^{j_2} \dots \partial_{x_d}^{j_d}$, $|\mathbf{j}| = j_1 + j_2 + \dots + j_d$, \mathbf{x} is in a poly-sector $\mathcal{S} = \{ \mathbf{x} : |\arg x_i| < \frac{\pi}{2} + \phi; |\mathbf{x}| > a \}$ in \mathbb{C}^d where $\phi < \frac{\pi}{2n}$, $\mathbf{g} \left(\mathbf{x}, t, \{ \mathbf{y}_{\mathbf{j}} \}_{|\mathbf{j}|=0}^{n-1} \right)$ is a function analytic in $\{ \mathbf{y}_{\mathbf{j}} \}_{|\mathbf{j}|=0}^{n-1}$ near $\mathbf{0}$ vanishing as $|\mathbf{x}| \rightarrow \infty$. The results in hold for n -th order nonlinear *quasilinear* partial differential equations of the form

$$\mathbf{u}_t + \mathcal{P}(\partial_{\mathbf{x}}^{\mathbf{j}}) \mathbf{u} + \mathbf{g} \left(\mathbf{x}, t, \{ \partial_{\mathbf{x}}^{\mathbf{j}} \mathbf{u} \} \right) = 0 \quad (7.20)$$

where $\mathbf{u} \in \mathbb{C}^m$, for large $|\mathbf{x}|$ in S . Generically, the constant coefficient operator $\mathcal{P}(\partial_{\mathbf{x}})$ in the linearization of $\mathbf{g}(\infty, t, \cdot)$ is diagonalizable. It is then taken to be diagonal, with eigenvalues \mathcal{P}_j . \mathcal{P} is subject to the requirement that for all $j \leq m$ and $\mathbf{p} \neq 0$ in \mathbb{C}^d with $|\arg p_i| \leq \phi$ we have

$$\operatorname{Re} \mathcal{P}_j^{[n]}(-\mathbf{p}) > 0 \tag{7.21}$$

where $\mathcal{P}^{[n]}(\partial_{\mathbf{x}})$ is the principal symbol of $\mathcal{P}(\partial_{\mathbf{x}})$. Then the following holds. (The precise conditions and results are given in [21].)

Theorem 7.22 (large $|\mathbf{x}|$ existence) *Under the assumptions above, for any $T > 0$ (7.20) has a unique solution \mathbf{u} that for $t \in [0, T]$ is $O(|\mathbf{x}|^{-1})$ and analytic in S .*

Determining asymptotic properties of solutions of PDEs is substantially more difficult than the corresponding question for ODEs. Borel-Laplace techniques, however, provide a very efficient way to overcome this difficulty. The paper shows that formal series solutions are actually Borel summable, a fortiori asymptotic, to actual solutions.

Condition 7.23 *The functions $\mathbf{b}_{\mathbf{q},\mathbf{k}}(\mathbf{x}, t)$ and $\mathbf{r}(\mathbf{x}, t)$ are analytic in $(x_1^{-\frac{1}{N_1}}, \dots, x_d^{-\frac{1}{N_d}})$ for large $|\mathbf{x}|$ and some $\mathbf{N} \in (\mathbb{N}^+)^d$.*

Theorem 7.24 *If Condition 7.23 and the assumptions of Theorem 7.22 are satisfied, then the unique solution \mathbf{f} found there can be written as*

$$\mathbf{f}(\mathbf{x}, t) = \int_{\mathbb{R}^{+d}} e^{-\mathbf{p} \cdot \mathbf{x}^{\frac{n}{n-1}}} \mathbf{F}_{1+}(\mathbf{p}, t) d\mathbf{p} \tag{7.25}$$

where \mathbf{F}_{1+} is (i) analytic at zero in $(p_1^{\frac{1}{nN_1}}, \dots, p_d^{\frac{1}{nN_d}})$; (ii) analytic in $\mathbf{p} \neq \mathbf{0}$ in the poly-sector $|\arg p_i| < \frac{n}{n-1}\phi + \frac{\pi}{2(n-1)}$, $i \leq d$; and (iii) exponentially bounded in the latter poly-sector.

Existence and asymptoticity of the formal power series follow as a corollary, using Watson’s lemma.

The analysis has been extended recently to the Navier-Stokes system in \mathbb{R}^3 ; see [26].

Chapter 8

Other important tools and developments

8.1 Resurgence, bridge equations, alien calculus, moulds

This is a powerful set of tools discovered by Écalle, which provide detailed analytic information on Borel transforms, linear and nonlinear Stokes phenomena and general summation rules along singular directions [33]. The recent article [52] provides a largely self-contained introduction.

8.2 Multisummability

Nongenerically, exponentials of different powers of x , such as e^{-x^2} and e^x , may occur in the transseries solutions of the same equation. If such is the case, no single critical time will work, and the formal solutions are effectively mixtures of solutions belonging to different Borel planes. Summation with respect to any single variable will result in superexponential growth and/or divergent expansions at the origin. For some reason, in applications, the need for full multisummability rarely occurs. More often a nongeneric equation can be effectively split into lower order, pure-type equations. In general though, *acceleration and multisummability* were introduced by Écalle, see [33] and [34], to adequately deal with mixed divergences in wide settings. In PDEs, however, it is often helpful to use acceleration operators since they can further simplify or regularize the problem.

We only sketch the general procedure, and refer the interested reader to [5], [13], [33] and [34], for a detailed analysis.

Multisummation consists in Borel transform with respect to the lowest power of x in the exponents of the transseries (resulting in oversummation

of some components of the mixture, and superexponential growth) and a sequence of transformations called accelerations (which mirror in Borel space the passage from one power in the exponent to the immediately larger one) followed by a final Laplace transform in the highest power of x .

More precisely ([34]):

$$\mathcal{L}_{k_1} \circ \mathcal{A}_{k_2/k_1} \circ \cdots \circ \mathcal{A}_{k_q/k_{q-1}} \mathcal{S}\mathcal{B}_{k_q} \tag{8.1}$$

where $(\mathcal{L}_k f)(x) = (\mathcal{L}f)(x^k)$, \mathcal{B}_k is the formal inverse of \mathcal{L}_k , $\alpha_i \in (0, 1)$ and the acceleration operator \mathcal{A}_α is formally the image, in Borel space, of the change of variable from x^α to x , and is defined as

$$\mathcal{A}_\alpha \phi = \int_0^\infty C_\alpha(\cdot, s) \phi(s) ds \tag{8.2}$$

and where, for $\alpha \in (0, 1)$, the kernel C_α is defined as

$$C_\alpha(\zeta_1, \zeta_2) := \frac{1}{2\pi i} \int_{c-i\infty}^{c+i\infty} e^{\zeta_2 z - \zeta_1 z^\alpha} dz \tag{8.3}$$

where we adapted the notations in [5] to the fact that the formal variable is large. In our example, $q = 2, k_2 = 1, k_1 = 2$.

In [13], W. Balsler, B.L.J. Braaksma, J.-P. Ramis, and Y. Sibuya proved multisummability of series solutions of general nonlinear meromorphic ODEs in the spirit of Écalle’s theory.

Note 8.4 (i) Multisummability of type (8.1) can be equivalently characterized by decomposition of the series into terms which are ordinarily summable after changes of independent variable of the form $x \rightarrow x^\alpha$. This is shown in [5] where it is used to give an alternative proof of multisummability of series solutions of meromorphic ODEs, closer to the cohomological point of view of Ramis; see [45, 48, 49].

(ii) More general multisummability is described by Écalle [34], allowing, among others, for stronger than power-like acceleration. This is relevant to more general transseries equations.

8.3 Hyperasymptotics

Once a series has been summed to the least term, with exponential accuracy, there is no reason to stop there. Often asymptotic expansions for the difference between the function and the truncated series can be obtained too.

This new expansion can also be summed to the least term. The procedure can be continued in principle *ad infinitum*. In practice, after a few iterations,

the order of truncation becomes one and no further improvement is obtained in this way.

The overall gain in accuracy, however, is significant in applications.

One can alternatively choose to truncate the successive series far beyond their least term, in a prescribed way which improves even the exponential order of the error (at the expense of making the calculation substantially more laborious).

This is an entry point into hyperasymptotics, a theory in its own right, and numerous papers address it. The concept and method were discovered by Berry [9], with ideas going back to Dingle [29] and further developed by Berry, Delabaere, Howls and Olde Daalhuis; see e.g. [7] and [46].

References

- [1] M. Abramowitz and I.A. Stegun, *Handbook of Mathematical Functions with Formulas, Graphs, and Mathematical Tables*, 9th printing. New York: Dover, pp. 804–806, (1972).
- [2] L. Ahlfors, *Complex Analysis*, McGraw-Hill, New York, (1979).
- [3] M. Aschenbrenner and L. van den Dries, Asymptotic differential algebra, in *Analyzable Functions and Applications*, pp. 49–85, Contemp. Math., 373, Amer. Math. Soc., Providence, RI, (2005).
- [4] W. Balsler, B.L.J. Braaksma, J-P. Ramis and Y. Sibuya, *Asymptotic Anal.* 5, no. 1, pp. 27–45, (1991).
- [5] W. Balsler, *From Divergent Power Series to Analytic Functions*, Springer-Verlag, (1994).
- [6] C. Bender and S. Orszag, *Advanced Mathematical Methods for Scientists and Engineers*, McGraw-Hill, (1978), Springer-Verlag, (1999).
- [7] M.V. Berry and C.J. Howls, *Proceedings: Mathematical and Physical Sciences*, vol. 430, No. 1880, pp. 653–668, (1990).
- [8] M.V. Berry and C.J. Howls, *Proc. Roy. Soc. London Ser. A* 443, no. 1917, pp. 107–126, (1993).
- [9] M.V. Berry, *Proc. R. Soc. Lond. A* 422, pp. 7–21, (1989).
- [10] M.V. Berry, *Proc. R. Soc. Lond. A* 430, pp. 653–668, (1990).
- [11] M V. Berry, *Proc. Roy. Soc. London Ser. A* 434 no. 1891, pp. 465–472, (1991).
- [12] E. Borel, *Leçons sur les Series Divergentes*, Gauthier-Villars, Paris, (1901).
- [13] B.L.J. Braaksma, *Ann. Inst. Fourier*, Grenoble, 42, 3, pp. 517–540, (1992).
- [14] A. Cauchy, *Oeuvres Complètes d'Augustin Cauchy*, publiées sous la direction scientifique de l'Académie de sciences et sous les auspices du m. le ministre de l'instruction publique. Gauthier-Villars, Paris, (1882–90).

- [15] M.D. Kruskal and P.A. Clarkson, *Studies in Applied Mathematics*, 86, pp 87–165, (1992).
- [16] E.A. Coddington and N. Levinson, *Theory of Ordinary Differential Equations*, McGraw-Hill, New York, (1955).
- [17] O. Costin and M.D. Kruskal, *Proc. R. Soc. Lond. A*, 452, pp. 1057–1085, (1996).
- [18] O. Costin and M.D. Kruskal, *Comm. Pure Appl. Math.*, 58, no. 6, pp. 723–749, (2005).
- [19] O. Costin and M. D. Kruskal, *Proc. R. Soc. Lond. A*, 455, pp. 1931–1956, (1999).
- [20] O. Costin and R.D. Costin, *SIAM J. Math. Anal.* 27, no. 1, pp. 110–134, (1996).
- [21] O. Costin and S. Tanveer, *Ann. Inst. H. Poincaré Anal. Non Linéaire* 24, no. 5, pp. 795–823, (2007).
- [22] O. Costin, *Analyzable functions and applications*, pp. 137–175, *Contemp. Math.*, 373, Amer. Math. Soc., Providence, RI, (2005).
- [23] O. Costin, *Duke Math. J.*, 93, No. 2, (1998).
- [24] O. Costin and R.D. Costin, *Inventiones Mathematicae*, 145, 3, pp. 425–485, (2001).
- [25] O. Costin, *IMRN* 8, pp. 377–417, (1995).
- [26] O. Costin, G. Luo and S. Tanveer, *Integral Equation representation and longer time existence solutions of 3-D Navier-Stokes*, submitted. <http://www.math.ohio-state.edu/~tanveer/ictproc.ns.5.pdf> (last accessed: August 2008).
- [27] O. Costin and S. Garoufalidis *Annales de L'institut Fourier*, vol. 58 no. 3, pp. 893–914, (2008).
- [28] E. Delabaere and C.J. Howls, *Duke Math. J.* 112, no. 2, 199–264, (2002).
- [29] R.B. Dingle, *Asymptotic Expansions: Their Derivation and Interpretation*, Academic Press, London-New York, (1973).
- [30] N. Dunford and J.T. Schwartz, *Linear Operators, Part I: General Theory*, Interscience, New York, (1960).
- [31] J. Écalle and F. Menous, *Publicacions Matemàtiques*, vol. 41, pp. 209–222, (1997).
- [32] J. Écalle, Preprint 90-36 of Université de Paris-Sud, (1990).
- [33] J. Écalle, *Fonctions Resurgentes*, Publications Mathématiques D'Orsay, (1981).

- [34] J. Écalle, in *Bifurcations and periodic orbits of vector fields*, NATO ASI Series, vol. 408, (1993).
- [35] G.A. Edgar, *Transseries for Beginners*, preprint, (2008).
http://www.math.ohio-state.edu/~edgar/WG_W08/edgar/transseries.pdf
(last accessed: August 2008).
- [36] L. Euler, De seriebus divergentibus, *Novi Commentarii academiae scientiarum Petropolitanae* (1754/55) 1760, pp. 205–237, reprinted in *Opera Omnia Series*, I vol. 14, pp. 585–617. Available through The Euler Archive at www.EulerArchive.org (last accessed, August 2008).
- [37] E. Goursat, *A Course in Mathematical Analysis, vol. 2: Functions of a Complex Variable & Differential Equations*, Dover, New York, (1959).
- [38] C.G. Hardy, *Divergent Series*, Oxford, (1949).
- [39] E. Hille and R.S. Phillips, *Functional Analysis and Semigroups*, AMS Providence, R.I. (1957).
- [40] J. van der Hoeven, *Transseries and Real Differential Algebra*, Lecture Notes in Mathematics 1888, Springer, New York, (2006).
- [41] A.S.B. Holland, *Introduction to the Theory of Entire Functions*, Academic Press, US, (1973).
- [42] I. Kaplansky, *Differential Algebra*, Hermann, Paris, (1957).
- [43] T. Kawai and Y. Takei, *Advances in Mathematics*, 203, 2, pp. 636–672 (2006).
- [44] D.A. Lutz, M. Miyake and R. Schäfke, *Nagoya Math. J.* 154, 1, (1999).
- [45] J. Martinet and J-P. Ramis, *Annales de l'Institut Henri Poincaré (A) Physique théorique*, 54 no. 4, pp. 331–401, (1991).
- [46] A.B. Olde Daalhuis, *R. Soc. Lond. Proc. Ser. A Math. Phys. Eng. Sci.* 454, no. 1968, pp. 1–29, (1998).
- [47] M. Reed and B. Simon, *Methods of Modern Mathematical Physics*, Academic Press, New York, (1972).
- [48] J-P. Ramis, *Asterisque*, V. 59-60, pp. 173–204, (1978).
- [49] J-P. Ramis, *C.R. Acad. Sci. Paris*, tome 301, pp. 99–102, (1985).
- [50] J.F. Ritt *Differential Algebra*, American Mathematical Society, New York, (1950).
- [51] W. Rudin, *Real and Complex Analysis*, McGraw-Hill, New York, (1987).
- [52] D. Sauzin, *RIMS Kokyuroku* 1493, pp. 48–117, (31/05/2006).
<http://arxiv.org/abs/0706.0137v1>. (last accessed: August 2008).

- [53] Y. Sibuya, *Global Theory of a Second Order Linear Ordinary Differential Equation with a Polynomial Coefficient*, North-Holland, Amsterdam-New York, (1975).
- [54] A. Sokal, *J. Math. Phys.*, 21 pp. 261–263, (1980).
- [55] G.G. Stokes *Trans. Camb. Phil. Soc.*, 10, pp. 106–128. Reprinted in *Mathematical and Physical papers by late sir George Gabriel Stokes*, Cambridge University Press, vol. IV, pp. 77–109, (1904).
- [56] P. Suppes, *Axiomatic Set Theory*, Dover, (1972).
- [57] E.C. Titchmarsh, *The Theory of Functions*, Oxford University Press, USA; 2nd edition, (1976).
- [58] W. Wasow *Asymptotic Expansions for Ordinary Differential Equations*, Interscience Publishers, New York, (1968).
- [59] E. Zermelo, *Mathematische Annalen*, 65, pp. 261–281, (1908).