



Parts for Trucks, Trailers & Buses

9

ELECTRICAL

*Proven, reliable and
always innovative.*

TRP® offers reliable aftermarket products that are designed and tested to exceed customers' expectations regardless of the vehicle make, model or age.



COILS • BUZZERS • CONNECTORS • RELAYS •
FUSES • LOCKS, PLUGS, & SEALS • SWITCHES •
TERMINALS • TERMINAL ENDS • TOOLS



Tested. Reliable. Guaranteed.

Electrical

Choosing the right replacement part or service for your vehicle—whether you own one, or a fleet—is one of the most important decisions you can make for your business. And, with tested TRP® parts it’s an easy decision.

Regardless of the make you drive, TRP® quality replacement parts are engineered to fit your truck, trailer or bus. Choose the parts that give you the best value for your business. Check them out at an approved TRP® retailer near you.

The cross reference information in this catalog is based upon data provided by several industry sources and our partners. While every attempt is made to ensure the information presented is accurate, we bear no liability due to incorrect or incomplete information.

Product Availability

Due to export restrictions and market demands, not all products are always available in every location. Check for availability in your area with your local TRP® Distributor.

No part of this marketing material may be reproduced in any manner without written permission from TRP® North America.

TABLE OF CONTENTS

ELECTRICAL

COILS & RECEPTACLES

Cables & Receptacles9-6

CABLE TIES

Ties9-18

BUZZERS

Warning Buzzers9-22

CIRCUIT BREAKERS

Circuit Breakers9-23

CONNECTORS

Connectors9-28

ELECTRICAL BLOCKS, STORAGE & TUBING

Blocks, Storage & Tubing9-37

ELECTRICAL RELAYS

Relays9-40

FLASHERS

Electronic Flashers9-41

TRP® North America

750 Houser Way N.
Renton, WA 98057

www.trpparts.com

FUSES & FUSE HOLDERS

Fuses.....9-42

LOCKS, PLUGS & SEALS

Cable, Plugs and Seals9-46

SWITCHES

Switches9-49

TERMINALS - HEAT SHRINKABLE

Terminals.....9-63

TERMINALS - NYLON INSULATED

Terminals.....9-68

TERMINAL BLOCK & BUS BARS

Bus Bars and Terminal Block..... 9-75

TERMINAL ENDS

Spade/Slide9-76

Sleeves, Sockets & Pins9-80

TOOLS

Cable Tie Tools.....9-84

Deutsch Connector Tools9-85

Miscellaneous Tools9-85

WIRE

Primary Wire.....9-86

CROSS REFERENCE

Vendor Cross Reference9-88



3-IN-1 ELECTRICAL & AIR HOSE ASSEMBLIES

ELECTRICAL HOSE

FEATURES & BENEFITS

- » Spiral wrapped for organized clean look
- » Outstanding kink and abrasion resistance
 - Spring-wrapped compression contact pins
 - Chemical and abrasion resistant
 - QCP™ assemblies are field repairable in seconds!
 - WEATHER-TITE™ seal blocks all contaminants from entering the electrical system



AIR HOSE

FEATURES & BENEFITS

- » Spiral wrapped for organized clean look
- » Outstanding kink and abrasion resistance
 - Large grips for easy coupling/uncoupling and hose support
 - Tractor end includes swivel fitting for easy installation
 - Provides excellent abrasion-resistance and resists cracking, kinking and weathering

RELATED PARTS

- » Gladhands
- » Hosetenna



3-IN-1 ELECTRICAL & AIR HOSE ASSEMBLIES

TRP	Description
PE13000	12', ABS Black Rubber, Straight
PE13050	15', ABS Black Rubber, Straight





ELECTRICAL CABLES

FEATURES & BENEFITS

- » Designed for trailers with ABS systems
- » 8-gauge ground wire handle heavy electrical loads
- » Large grips on plugs are designed for use with gloves
- » Machine-crimped pins offer protection against wire pull-out
- » 12' cables for dollies & day cabs
- » 15' cables for use with pogo sticks or tracker bars



Large grips, machine crimped pins



PE15300 / PE15800

COILED ELECTRICAL ASSEMBLIES

TRP® Coiled Electrical Assemblies provide power to the trailer's lights, ABS, interior lighting and weighing or tracking systems. TRP® 12' Cables are typically used for dollies and day cabs. TRP® 15' Cables are designed for over-the-road and tractor-trailers with pogo sticks or tracker bars where a sliding fifth wheel is used.

In order to ensure proper corrosion protection, electrical assemblies should be greased with dielectric grease each time they are disconnected.

CROSS REFERENCE

TRP®	Tramec	Techtran	Phillips	Sureflex	Philatron	Velvac
PE15300	4AA17	7ATG522MG	30-9620 / 30-4620	SFA155CEN	2415CL	590161
PE15800	4AA15	7ATG522MG	30-4621	SFA155CEN	2415CM	590161

Scan the code for more information.
Get the free mobile app at <http://gettag.mobi>



COILS & RECEPTACLES

TRP® COILED ELECTRICAL CABLES

LIFELINES BETWEEN THE TRACTOR AND TRAILER.

Designed with the tough heavy-duty market in mind, TRP® Electrical Coils are designed to exceed your expectations!

- Nylon Plugs will not corrode or freeze into a socket. Lightweight reducing wear and tear on sockets.
- Tough cable jackets resists chemicals, cutting, abrasion, gasoline, ozone, solvents and sunlight. Guaranteed for up to three years against coil memory loss.
- Complies with SAE J2222, J2394(ABS), J560B

ABS Coil Features & Benefits

- 1/8, 2/10, 4/12 Ga.
- Meets SAE J2394
- 3 Year Warranty



ABS 7-WAY COILED CABLES - 12' (3.7M)

Table 9-1: ABS 7-Way Coiled Cables - 12' (3.7m)

Part No.	Description
PE12300	ABS Electrical Cable, Nylon Plug
PE12340	ABS Electrical Cable with 40" Lead, Nylon Plug
PE12800	ABS Electrical Cable, Metal Plug

CROSS REFERENCE FOR ABS 7-WAY COILED CABLES - 12'

Table 9-2: ABS 7-Way Coiled Cables - 12' Cross Reference

TRP®	Tramec	Midland	Techtran	Phillips	Sloan	Philatron
PE12300		BE27070	7ATG222MG	30-9321	421129	2-412-CL
PE12800		BE27070	7ATG222MG	30-9321	421129	2-412-CL

ABS 7-WAY COILED CABLES - 15' (4.6M)

Connectors
See Page 9-28



PE15800

Table 9-3: ABS 7-Way Coiled Cables - 15' (4.6m)

Part No.	Description
PE15300	ABS Electrical Cable, Nylon Plug
PE15340	ABS Electrical Cable with 40" Lead, Nylon Plug
PE15370	ABS Electrical Cable with 72" Lead, Nylon Plug
PE15800	ABS Electrical Cable, Metal Plug
PE15840	ABS Electrical Cable with 48" Lead, Metal Plug
PE15870	ABS Electrical Cable with 72" Lead, Metal Plug

CROSS REFERENCE FOR ABS 7-WAY COILED CABLES - 15'

Table 9-4: ABS 7-Way Coiled Cables - 15' Cross Reference

TRP®	Tramec	Midland	Techtran	Phillips	Sloan	Philatron
PE15370						
PE15340		BE27072		30-9920		2-415-40-CL2
PE15300	4AA15	BE27071	7ATG522MG	30-9620 OR 30-9621	421130	2-415-CL
PE15870						
PE15840		BE27072		30-9920		2-415-40-CL2
PE15800	4AA15	BE27071	7ATG522MG	30-9620 OR 30-9621	421130	2-415-CL

ELECTRICAL

Heavy Duty Coil Features & Benefits

- 1/10, 6/12 Ga.
- Meets SAE J2394



HEAVY DUTY 7-WAY COILED CABLES - 12' (3.7M)

Table 9-5: 7-Way Coiled Cables - 12' & 15'

Part No.	Description
PE12100	Heavy Duty Electrical Cable, Nylon Plug
PE12600	Heavy Duty Electrical Cable, Metal Plug

CROSS REFERENCE FOR HEAVY DUTY 7-WAY COILED CABLES - 12'

Table 9-6: Heavy Duty 7-Way Coiled Cables - 12' Cross Reference

TRP®	Tramec	Midland	Techtran	Phillips	Sloan	Philatron
PE12100		BE27029 OR BE27045	7STS222MG	22-4321	421007	2-612CL
PE12600		BE27029 OR BE27045	7STS222MG	22-4321	421007	2-612CL

ELECTRICAL



HEAVY DUTY 7-WAY COILED CABLES - 15' (4.6M)

Table 9-7: 7-Way Coiled Cables - 15'

Part No.	Description
PE15100	Heavy Duty Electrical Cable, Nylon Plug
PE15170	Heavy Duty Electrical Cable, Nylon Plug
PE15600	Heavy Duty Electrical Cable, Metal Plug
PE15670	Heavy Duty Electrical Cable with 72" Lead, Metal Plug

CROSS REFERENCE FOR HEAVY DUTY 7-WAY COILED CABLES - 15'

Table 9-8: Heavy Duty 7-Way Coiled Cables - 15' Cross Reference

TRP®	Tramec	Midland	Techtran	Phillips	Sloan	Philatron
PE15170	45A16			22-9721		2-617-CL2
PE15100	45A15	BE27031 OR BE27046	7STS522MG	22-4621 OR 22-9621	421115	2-615-CL
PE15670	45A16			22-9721		2-617-CL2
PE15600	45A15	BE27031 OR BE27046	7ATG222MG	22-4621 OR 22-9621	421115	2-615-CL

Economy Coil Features & Benefits

- 1/12, 6/14 Ga.
- Meets SAE J2394



ECONOMY 7-WAY COILED CABLES - 12' (3.7M)

Table 9-9: Economy 7-Way Coiled Cables - 12'

Part No.	Description
PE12200	Economy Electrical Cable, Nylon Plug
PE12700	Economy Electrical Cable, Metal Plug

CROSS REFERENCE FOR ECONOMY 7-WAY COILED CABLES - 12'

Table 9-10: Economy 7-Way Coiled Cables - 12' Cross Reference

TRP®	Tramec	Midland	Techtran	Phillips	Sloan	Philatron
PE12200	47A15	BE27019 OR BE27048	7MTY522MG	24-4621	421113	2-815-CL
PE12700	47A15	BE27019 OR BE27048	7MTY522MG	24-4621	421113	2-815-CL



ECONOMY 7-WAY COILED CABLES - 15' (4.6M)

Table 9-11: Economy 7-Way Coiled Cables - 15'

Part No.	Description
PE15200	Economy Electrical Cable, Nylon Plug
PE15700	Economy Electrical Cable, Metal Plug

CROSS REFERENCE FOR ECONOMY 7-WAY COILED CABLES - 15'

Table 9-12: Economy 7-Way Coiled Cables - 15' Cross Reference

TRP®	Tramec	Midland	Techtran	Phillips	Sloan	Philatron
PE15200	47A15	BE27019 OR BE27048	7MTY522MG	24-4621	421113	2-815-CL
PE15700	47A15	BE27019 OR BE27048	7MTY522MG	24-4621	421113	2-815-CL

ISO Coil Features & Benefits

- 1/8ga, 2/10ga, 4/12 Ga.
- Meets SAE J2394



ISO 7-WAY COILED CABLES - 12' (3.7M)

Table 9-13: ISO 7-Way Coiled Cables - 12'

Part No.	Description
PE12900	ISO Electrical Cable, Metal Plug

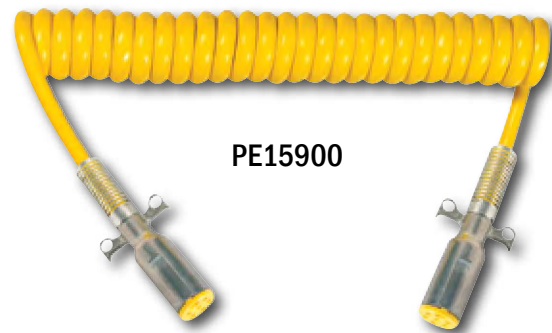

ISO 7-WAY COILED CABLES - 15' (4.6M)

Table 9-14: ISO 7-Way Coiled Cables - 15'

Part No.	Description
PE15400	ISO Electrical Cable, Nylon Plug
PE15440	ISO Electrical Cable with 40" Lead, Nylon Plug
PE15900	ISO Electrical Cable, Metal Plug
PE15940	ISO Electrical Cable with 48" Lead, Metal Plug

ABS Straight Cable Features & Benefits

- 1/8, 2/10, 4/12 Ga.
- Meets SAE J2394



ABS 7-WAY STRAIGHT CABLES - 10' (3m)

Table 9-15: 7-Way Straight Cables - 10'

Part No.	Description
PE10350	ABS Electrical Cable, Nylon Plug
PE10850	ABS Electrical Cable, Metal Plug

ABS 7-WAY STRAIGHT CABLES - 12' (3.7m)

Table 9-16: ABS 7-Way Straight Cables - 12'

Part No.	Description
PE12350	ABS Electrical Cable, Nylon Plug
PE12850	ABS Electrical Cable, Metal Plug

ABS 7-WAY STRAIGHT CABLES - 15' (4.6m)



Table 9-17: 7-Way Straight Cables - 15'

Part No.	Description	Length	Wire Count/Gauge	Plug Material
PE15350	ABS Electrical Cable	15 ft (4.6m)	1-8ga, 2-10ga, 4-12ga	Nylon
PE15850	ABS Electrical Cable	15 ft (4.6m)	1-8ga, 2-10ga, 4-12ga	Metal

ELECTRICAL

Heavy Duty Straight Cable Features & Benefits

- 1/12, 6/14 Ga.
- Meets SAE J2394



HEAVY DUTY 7-WAY STRAIGHT CABLES - 10' (3m)

Table 9-18: 7-Way Straight Cables - 10'

Part No.	Description
PE10150	Heavy Duty Electrical Cable, Nylon Plug
PE10650	Heavy Duty Electrical Cable, Metal Plug

HEAVY DUTY 7-WAY STRAIGHT CABLES - 12' (3.7m)

Table 9-19: Heavy Duty 7-Way Straight Cables - 12'

Part No.	Description
PE12150	Heavy Duty Electrical Cable, Nylon Plug
PE12650	Heavy Duty Electrical Cable, Metal Plug



HEAVY DUTY 7-WAY STRAIGHT CABLES - 15' (4.6m)

Table 9-20: 7-Way Straight Cables - 15'

Part No.	Description
PE15150	Heavy Duty Electrical Cable, Nylon Plug
PE15650	Heavy Duty Electrical Cable, Metal Plug

ISO Straight Cable Features & Benefits

- 1/8, 2/10, 4/12 Ga.
- Meets SAE J2394



PE10950

ISO 7-WAY STRAIGHT CABLES - 10' (3m)

Table 9-21: 7-Way Straight Cables - 10'

Part No.	Description
PE10450	ISO Electrical Cable, Nylon Plug
PE10950	ISO Electrical Cable, Metal Plug

ISO 7-WAY STRAIGHT CABLES - 12' (3.7m)

Table 9-22: ISO 7-Way Straight Cables - 12'

Part No.	Description
PE12450	ISO Electrical Cable, Nylon Plug
PE12950	ISO Electrical Cable, Metal Plug

ISO 7-WAY STRAIGHT CABLES - 15' (4.6m)



PE15950

Table 9-23: 7-Way Straight Cables - 15'

Part No.	Description
PE15950	ISO Electrical Cable, Metal Plug



ELECTRICAL PRODUCTS



PE27100

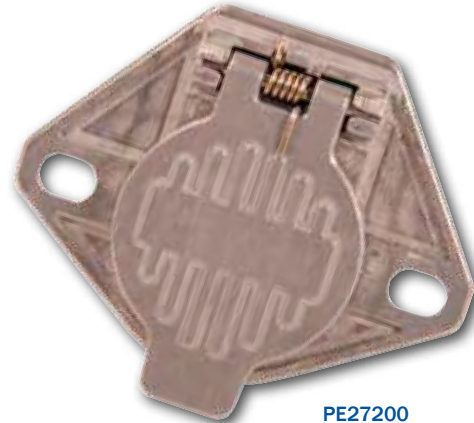

PE27200

PLUG

FEATURES & BENEFITS

- » Large finger grips for easy coupling/uncoupling
- » Strong Cable Guard Spring to support heavy cables.
- » Locking tab to provide solid plug to receptacle connection
- » Made with heavy duty zinc die-cast housings

RECEPTACLE

FEATURES & BENEFITS

- » 2 elongated holes for easy mounting
- » Split pins to ensure connectivity to the plug
- » Locking tab to provide solid plug to receptacle connection
- » Made with heavy duty zinc die-cast housings

CROSS REFERENCE

TRP®	Description	Tramec	Midland	Techtran	Phillips
PE27100	7-Way Plug, Zinc Die Cast Housing	38197	BE23784	670-71SG	15-730
PE27200	7-Way Receptacle, 2 Hole, Zinc Die Cast Housing	38497	BE23703	670-72	15-720



Scan the code for more information.
Get the free mobile app at <http://gettag.mobi>

ELECTRICAL PLUGS & RECEPTACLES



Table 9-24: Electrical Plugs & Receptacles

Part No.	Description
PE20400	Rubber Boot for Die-Cast, 7-Way Receptacle
PE21100	Single Pole Metal Plug
PE21200	Single Pole Receptacle, Zinc Die Cast Housing, 2-Hole Mounting
PE24100	4-Way Metal Plug, Zinc Die-Cast Housing
PE24200	4-Way Receptacle, Zinc Die Cast Housing, 2-Hole Mounting
PE26100	6-Way Plug, Zinc Die Cast Housing, Wire Insertion
PE26200	6-Way Receptacle, Zinc Die Cast Housing, 2-Hole Mounting
PE27100	7-Way Plug, Zinc Die Cast Housing
PE27200	7-Way Receptacle, Zinc Die Cast Housing, 2-Hole Mounting

POGO STICK



Table 9-25: Pogo Stick

Part No.	Description	Length	Material
PE20300	Swivel Pogo Stick	40" (101cm)	Chrome

ELECTRICAL

CABLE TIES

STANDARD TIES

- Engineered & manufactured for maximum performance and quality
- Varying strengths and lengths for each individual application



Table 9-26: Standard Ties

Part No.	Length	Tensile (lb.)	Color	Package Qty.
CT01111	4" (10.2cm)	18	Black	100
CT01112	4" (10.2cm)	18	Natural	100
CT01114	5-3/4" (14.6cm)	18	Black	100
CT01115	5-3/4" (14.6cm)	18	Natural	100
CT01116	5-3/4" (14.6cm)	30	Black	100
CT01117	5-3/4" (14.6cm)	30	Natural	100
CT03111	8" (20.3cm)	18	Black	100
CT03112	8" (20.3cm)	18	Natural	100
CT03316	8" (20.3cm)	50	Black	100
CT03317	8" (20.3cm)	50	Natural	100
CT03517	8-1/2" (21.6cm)	120	Black	50
CT03718	8-3/4" (22.2cm)	250	Black	25
CT04311	11-3/4" (29.8cm)	50	Black	100
CT04312	11-3/4" (29.8cm)	50	Natural	100
CT04313	11-3/4" (29.8cm)	50	Red	100
CT05317	15-1/2" (39.4cm)	50	Black	100
CT05318	15-1/2" (39.4cm)	50	Natural	100
CT05512	15-1/4" (38.7cm)	120	Black	50
CT05513	15-1/4" (38.7cm)	120	Natural	50
CT06518	21" (53.3cm)	150	Black	25
CT06519	21" (53.3cm)	150	Natural	25
CT06712	20" (50.8m)	250	Black	25
CT08512	32" (81.3cm)	150	Black	50
CT09512	37" (94cm)	150	Black	25
CT09711	35" (88.9cm)	250	Natural	25

SPECIALTY TIES - BUTTON HEAD

- Two-piece tie providing for parallel entry and exit through the head
- Manufactured from black, high-impact nylon 6/6
- The strap contains serrations on both sides and the head has two opposed pawls covered by a spherical dome top
- The design enables the strap to be directed clockwise or counter clockwise prior to insertion into the head, enabling bidirectional looping



Tools

See Page 9-84



Table 9-27: Specialty Ties-Button Head

Part No.	Length	Tensile (lb.)	Color	Package Qty.
CTB3520	9-1/2" (24.1cm)	100	Black	10
CTB5518	15" (38.1cm)	100	Black	10
CTB5519	15" (38.1cm)	120	Black	10

SPECIALTY TIES - DUAL CLAMP

- Designed to provide parallel spacing between hoses, wires, cables, and tubing, protecting them from abrasion
- An optional mounting hole for securing bundles along the chassis of trucks, trailers, and automobiles
- The unique one-piece design features the dual head centered on the strap



Table 9-28: Specialty Ties - Dual Clamp

Part No.	Length	Tensile (lb.)	Color	Package Qty.
CTD6511	9-1/4" (23.4cm)	150	Black	50

SPECIALTY TIES - MOUNTABLE



Table 9-29: Specialty Ties - Mountable

Part No.	Characteristic	Length	Tensile (lb.)	Color	Package Qty.
CT3312M0	Fir Tree	8" (20.3cm)	50	Black	10
CTM2111	#8 Screw	6-1/4" (15.9cm)	30	Black	100
CTM2112	#8 Screw	6-1/4" (15.9cm)	30	Natural	100
CTM2212	#10 Screw	8-1/2" (21.6cm)	50	Black	100
CTM2213	#10 Screw	8-1/2" (21.6cm)	50	Natural	100
CTM3313	Arrow Head	8" (20.3cm)	50	Black	100
CTM3314	Heat Stable, Tree	8" (20.3cm)	50	Black	10
CTM5512	1/4" Screw	16-1/4" (41.3cm)	120	Black	50
CTM5513	1/4" Screw	16-1/4" (41.3cm)	120	Natural	50
CTM5520	1/4"-20 Stud	16-1/4" (41.3cm)	120	Black	10
CTM6311	#10 Screw	16" (40.6cm)	50	Black	100
CTM6312	#10 Screw	16" (40.6cm)	50	Natural	100

SPECIALTY TIES - RELEASABLE

- Releasable cable ties provide easy removal as well as reusabilit



Table 9-30: Specialty Ties - Releasable

Part No.	Characteristic	Length	Tensile (lb.)	Color	Package Qty.
CTR3719	Releasable	9" (22.9cm)	250	Black	25

STAINLESS STEEL TIES

- Self-locking, ball bearing mechanism enables quick and easy installation
- Fully enclosed head does not allow dirt to interfere with locking mechanism
- High tensile strength option adds strength and safety on heavy-duty applications
- Available in medium corrosion-resistance
- 304 stainless and high corrosion-resistance
- 316 stainless steel



Table 9-31: Stainless Steel Ties

Part No.	Length	Tensile (lb.)	Package Qty.
CTS1512	5" (12.7cm)	150	10
CTS1513	5" (12.7cm)	150	10
CTS2513	7-1/2" (19.1cm)	150	10
CTS2514	7-1/2" (19.1cm)	150	10
CTS2715	8" (20.1cm)	250	10
CTS2716	8" (20.1cm)	250	10
CTS5513	14-5/16" (36.3cm)	150	10
CTS5514	14-5/16" (36.3cm)	150	10
CTS5715	14-5/16" (36.3cm)	250	10
CTS5716	14-5/16" (36.3cm)	250	10
CTS6514	20-1/2" (52.1cm)	150	10
CTS6515	20-1/2" (52.1cm)	150	10
CTS6716	20-1/2" (52.1cm)	250	10
CTS6717	20-1/2" (52.1cm)	250	10
CTS7511	26-13/16" (68.1cm)	150	10
CTS7513	26-13/16" (68.1cm)	150	10
CTS7712	26-13/16" (68.1cm)	250	10
CTS7714	26-13/16" (68.1cm)	250	10
CTS8416	33" (83.8cm)	250	10
CTS8513	33" (83.8cm)	150	10
CTS8514	33" (83.8cm)	150	10
CTS8715	33" (83.8cm)	250	10

BUZZERS

WARNING BUZZERS



4099CHS



BR1010



BR10150



BR10200



BR10350



BR10400



BR10500



G2375

Table 9-32: Warning Buzzers

Part No.	Description
4099CHS	Rectangular with Bracket and 2 Terminals, Navistar 594186C1
BR1010	Round, 2 Blade Terminals with Screws
BR10150	Round, 2 Blade Terminals
BR10200	Round, 4 Blade Terminals with Mounting Bracket
BR10350	Rectangular w/ Bracket and 2 Blade Terminals
BR10400	Rectangular w/ Bracket, 4 Blade Terminals
BR10500	Rectangular - Circuit Board Mounted (Assembly for Instrument Panel)
G2375	Square, 2 Blade Terminals

CIRCUIT BREAKERS

PLUG-IN CIRCUIT BREAKERS

Plug-in circuit breakers can be used as replacements for MAXI™, ATC & ATO blade-type fuses.

- Metal cover aids in heat dissipation
- SAE Type 1 – Automatic Reset
- Voltage Rating: 12V DC
- Operating Temp: -20° F to +150° F
- Approvals: Complies with SAE J553

SAE Type 1–Auto Reset

Cycles or continuously resets until the fault is corrected. Type 1 circuit breakers are typically used to protect circuits that occasionally experience momentary overloads such as wiper motor and headlamp circuits.

SAE Type II–Modified Reset

Non-cycling, remains in open position while there is power to the circuit. Resets when ignition is turned off. Type II circuit breakers are typically used in applications where fuse replacement is objectionable, such as power window, seat, and sunroof circuits.

SAE Type III–Manual Reset

Manually resettable circuit breakers remain in the open position until a button, lever, or other external reset device is manually depressed. Type III circuit breakers are typically used in applications where a manual reset is desired for safe diagnosis of a circuit fault.

LONG ATC/ ATO

Table 9-33: Long ATC/ ATO

Part No.	AMP
CC11050	5
CC11080	8
CC11100	10
CC11150	15
CC1120PLE0	20
CC11250	25
CC11300	30



CC11150



CC12150

For use w/ USD 15600 panel only.



CC13300



CC14300

LONG ATC/ ATO w/ LOCKING DIMPLES

Table 9-34: Long ATC/ ATO w/ Locking Dimples

Part No.	AMP
CC12050	5
CC12080	8
CC12100	10
CC12150	15
CC12250	25
CC12300	30

WIDE ATC/ ATO

Table 9-35: Wide ATC/ ATO

Part No.	AMP
CC13050	5
CC13100	10
CC13150	15
CC13200	20
CC13250	25
CC13300	30
CC13350	35
CC13400	40

MAXI™

Table 9-36: MAXI™

Part No.	AMP
CC14200	20
CC14250	25
CC14300	30
CC14350	35
CC14400	40
CC14500	50

STUD TERMINALS

STUD TERMINAL CIRCUIT BREAKERS WITH MOUNTING BRACKET

- (2) 10-32 studs, 1 attached mounting bracket (2"L x 0.625"W)
- SAE Type 1—Automatic Reset
- Voltage Rating: 12V DC
- Operating Temp: -10° F to +150° F
- Approvals: Complies with SAE J553

Table 9-37: Stud Terminal Circuit Breakers with Mounting Bracket

Part No.	AMP
CC23050	5
CC23080	8
CC23100	10
CC23150	15
CC23200	20
CC23250	25
CC23300	30
CC23400	40



STUD AND BLADE TERMINAL CIRCUIT BREAKERS

- (1) 10-32 stud, 1 double 0.250" blade terminal
- SAE Type 1—Automatic Reset
- Voltage Rating: 12V DC
- Operating Temp: -10° F to +150° F
- Approvals: Complies with SAE J553

Table 9-38: Stud and Blade Terminal Circuit Breakers

Part No.	AMP
CC24100	10
CC24150	15
CC24200	20
CC24250	25
CC24300	30
CC24400	40



STUD TERMINAL CIRCUIT BREAKERS

- (2) 10-32 0.56" studs
- SAE Type 1—Automatic Reset
- Voltage Rating: 12V DC
- Operating Temp: -10° F to +150° F
- Approvals: Complies with
- SAE J553

Table 9-39: Stud Terminal Circuit Breakers

Part No.	AMP
CC22050	5
CC22080	8
CC22150	15
CC22200	20
CC22250	25
CC22300	30
CC22400	40

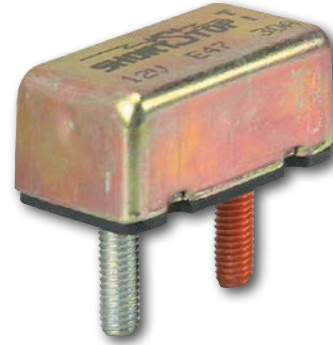

THERMAL CIRCUIT BREAKER TERMINALS

THERMAL CIRCUIT BREAKERS - BLADE W/ SCREW TERMINALS

- Weatherproof design
- SAE Type III—Manual Reset
- Voltage Rating: 120V AC, 30V DC
- Approvals: SAE J553 and J1625

Table 9-40: Thermal Circuit Breakers - Blade w/ Screw Terminals

Part No.	AMP
CC33150	15
CC33200	20
CC33250	25
CC33300	30
CC33350	35
CC33400	40



THERMAL CIRCUIT BREAKERS - STUD TERMINAL MOUNTING

Thermal circuit breakers use a thermal sensing element system to sense overload conditions and interrupt the flow of current.

- Weatherproof design
- SAE Type 1—Automatic Reset
- Voltage Rating: 120V AC, 30V DC
- Approvals: SAE J553 and J1625

Table 9-41: Thermal Circuit Breakers - Stud Terminal Mounting

Part No.	AMP
CC30350	35
CC30400	40
CC30450	45
CC30500	50
CC30600	60
CC30700	70
CC30800	80
CC30900	90
CC31050	105
CC31200	120
CC31350	135
CC31500	150



THERMAL CIRCUIT BREAKERS - SNAP-IN MOUNTING

- Snap-in design enables quick and easy installation
- (2) #8-32 screw terminals
- SAE Type III—Manual Reset
- Voltage Rating: 250V AC, 50V DC
- Interrupt Capacity: 1000 Amps

Table 9-42: Thermal Circuit Breakers - Snap-In Mounting

Part No.	AMP
CC32100	10
CC32150	15
CC32200	20
CC32300	30
CC32350	35



UNIVERSAL CIRCUIT BREAKER FOR ATC®/ATO® BLADE TYPE FUSES

- Snap-off terminals for greater flexibility
- SAE Type 1—Automatic Reset
- Voltage Rating: 12V DC
- Approvals: Complies with SAE J553C

Table 9-43: Universal Circuit Breaker for ATC®/ATO® Blade Type Fuses

Part No.	AMP
CC15100	10
CC15150	15
CC15200	20
CC15250	25
CC15300	30

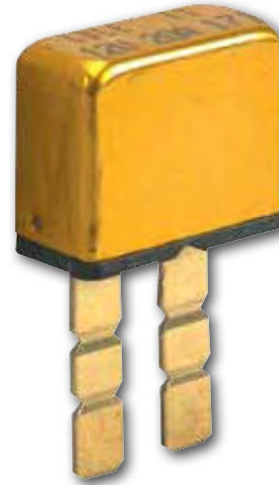

CONNECTORS

CONNECTOR BODIES & SHELLS - 1 WIRE



CN10400



CN10350



CN10300



CN10450



CN10150



CN10100



CN10050

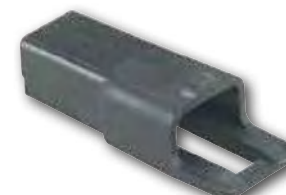

CN10550



CN10600



CN10500



CN10250

Table 9-44: Connector Bodies & Shells - 1 Wire

Part No.	Description	Type	Dimensions (mm)
CN10050	1 Wire, Deutsch 6 AWG	1 Wire	n/a
CN10100	1 Wire, Deutsch 8-10 AWG	1 Wire	n/a
CN10150	1 Wire, Deutsch 12-14 AWG	1 Wire	n/a
CN10250	1 Wire, Dill 90 Deg., 10 Stud	1 Wire	n/a
CN10300	1 Wire Female, Deutsch, 6 AWG	1 Wire	n/a
CN10350	1 Wire Female, Deutsch, 8-10 AWG	1 Wire	n/a
CN10400	1 Wire Female, Deutsch, 12-14 AWG	1 Wire	n/a
CN10450	1 Wire Female, Packard 56 Series	1 Wire	n/a
CN10500	1 Wire Female, Packard Weather Pack Tower	1 Wire	20.8 x 40.5 x 13.6
CN10550	1 Wire Male, Packard 56 Series	1 Wire	n/a
CN10600	1 Wire Male, Packard Weather Pack Shroud	1 Wire	17.3 x 45.1 x 16.5

CONNECTOR BODIES & SHELLS - 2 WIRE



Table 9-45: Connector Bodies & Shells - 2 Wire

Part No.	Description	Type	Dimensions (mm)
CN10650	2 Wire Female, Packard 56 Series	2 Wire	
CN10700	2 Wire Female, Packard 56 Series	2 Wire	
CN10750	2 Wire Female, Packard Metri-Pack 150 Series	2 Wire	17.3 x 21.4 x 12.5
CN10800	2 Wire Female, Packard Metri-Pack 150 Series	2 Wire	18.3 x 26 x 23
CN10850	2 Wire Female, Packard Metri-Pack 150 Series	2 Wire	18.4 x 27.1 x 16
CN10900	2 Wire Female, Packard Metri-Pack 150 Series	2 Wire	18.6 x 26 x 23
CN10950	2 Wire Female, Packard Metri-Pack 150 Series	2 Wire	18.6 x 26 x 23
CN11000	2 Wire Female, Packard Metri-Pack 280 Series	2 Wire	25 x 29.9 x 25.2
CN11100	2 Wire Female, Packard Weather Pack Tower	2 Wire	20.8 x 40.8 x 21.5
CN11150	2 Wire Male, Metri-Pack 480 Series	2 Wire	24.5 x 53 x 30.5
CN11200	2 Wire Male, Packard 56 Series	2 Wire	
CN11250	2 Wire Male, Packard Metri-Pack 280 Series	2 Wire	20 x 53 x 25.2
CN11300	2 Wire Male, Packard Metri-Pack 280 Series	2 Wire	22 x 40 x 17.3
CN11350	2 Wire Male, Packard Weather Pack Shroud	2 Wire	17.5 x 47 x 23.9

CONNECTOR BODIES & SHELLS - 3 WIRE



CN11750



CN11900



CN11700



CN11500



CN11450



CN11400



CN11850



CN11650



CN11600



CN11800



CN11550

Table 9-46: Connector Bodies & Shells - 3 Wire

Part No.	Description	Type	Dimensions (mm)
CN11400	3 Wire, Deutsch	3 Wire	
CN11450	3 Wire, Deutsch	3 Wire	
CN11500	3 Wire, Deutsch	3 Wire	
CN11550	3 Wire, Dill	3 Wire	
CN11600	3 Wire Female, 59 Series	3 Wire	
CN11650	3 Wire Female, Packard 56 Series	3 Wire	
CN11700	3 Wire Female, Packard Metri-Pack 280 Series	3 Wire	33.2 x 30.9 x 37.3
CN11750	3 Wire Female, Packard Weather Pack Tower	3 Wire	21 x 40.5 x 29.5
CN11800	3 Wire Male, Metri-Pack 630 Series	3 Wire	
CN11850	3 Wire Male, Packard 56 Series	3 Wire	
CN11900	3 Wire Male, Packard Weather Pack Shroud	3 Wire	19.2 x 47 x 32.1

CONNECTOR BODIES & SHELLS - 4 WIRE



CN12050



CN11950



CN12400



CN12350



CN12250



CN12150



CN12000

Table 9-47: Connector Bodies & Shells - 4 Wire

Part No.	Description	Dimensions (mm)
CN11950	4 Wire, Packard 56 Series	
CN12000	4 Wire Female, Packard 56 Series	
CN12050	4 Wire Female, Packard 56 Series	
CN12150	4 Wire Female, Packard Metri-Pack 280 Series	25 x 29.9 x 48.3
CN12250	4 Wire Female, Packard Weather Pack Tower	21 x 40.5 x 37.1
CN12350	4 Wire, Packard Weather Pack	24.9 x 47 x 24.1
CN12400	4 Wire, Packard Weather Pack	17.1 x 46.7 x 39.5

CONNECTOR BODIES & SHELLS - 5 WIRE



CN12700



CN12650



CN12550



CN12450



CN12500

Table 9-48: Connector Bodies & Shells - 5 Wire

Part No.	Description	Dimensions (mm)
CN12450	5 Wire	
CN12500	5 Wire Female, Packard Metri-Pack 280 Series	25 x 29.9 x 48.3
CN12550	5 Wire Female, Packard Metri-Pack 280 Series	41.5 x 30.6 x 35.5
CN12650	5 Wire Male, Packard Metri-Pack 280 Series	23.8 x 53 x 49.6
CN12700	5 Wire, Packard 56 Series	17 x 25 x 33

CONNECTOR BODIES & SHELLS - 6 WIRE



CN12600



CN13350



CN12800



CN13100



CN12900



CN13050



CN13000



CN13200



CN12750



CN12950



CN13250

Table 9-49: Connector Bodies & Shells - 6 Wire

Part No.	Description	Type	Dimensions (mm)
CN12600	6 Wire Female, Packard Weather Pack Tower	6 Wire	23.5 x 39.1 x 52.1
CN12750	6 Wire	6 Wire	
CN12800	6 Wire Data Bus Connector	6 Wire	
CN12900	6 Wire Female, Micro-Pack 100 Series	6 Wire	12.9 x 22.7 x 18.7
CN12950	6 Wire Female, Packard 56 Series	6 Wire	20.3 x 25.4 x 33
CN13000	6 Wire Female, Packard 56 Series	6 Wire	
CN13050	6 Wire Female, Packard 56 Series	6 Wire	
CN13100	6 Wire Female, Packard 58 Series	6 Wire	
CN13200	6 Wire Male, Packard 56 Series	6 Wire	
CN13250	6 Wire Male, Packard 56 Series	6 Wire	
CN13350	6 Wire Male, Packard Weather Pack Shroud	6 Wire	20.7 x 46.2 x 55.5

CONNECTOR BODIES & SHELLS - ADDITIONAL WIRE SIZES



CN13500



CN13650



CN13950



CN13600



CN14050



CN14000



CN13800



CN13700



CN13400

Table 9-50: Connector Bodies & Shells - Additional Wire Sizes

Part No.	Description	Dimension (mm)
BL10850	25 Wire, Packard	
CN12300	4 Wire, Packard, MP 280 Series	
CN13300	6 Wire, Packard, MP 280 Series	
CN13400	7 Wire, Deutsch	
CN13500	8 Wire Male, Packard Metri-Pack 280 Series	25.6 x 40 x 26.5
CN13550	9 Wire, Amp	
CN13600	9 Wire Female, Packard 56 series	
CN13650	12 Wire, Molex	
CN13700	14 Wire, Deutsch	
CN13750	14 Wire, Deutsch	
CN13800	14 Wire, Deutsch	



CN13750

Part No.	Description	Dimension (mm)
CN13850	16 Wire, Packard, MP 280 Series	
CN13900	16 Wire, Packard, MP 280 Series	
CN13950	16 Wire, Molex	
CN14000	17 Wire Male, Metri-Pack Mixed	28.8 x 46.6 x 63.8
CN14050	18 Wire, Molex	
CN14150	22 Wire, Packard Weather Pack Natural	65 x 47.7 x 55.2
CN14300	31 Wire, Deutsch	
CN14350	31 Wire, Deutsch	
CN14400	31 Wire, Deutsch	
CN14450	31 Wire, Deutsch	
CN14500	31 Wire, Deutsch	
CN14550	40 Wire, Ladd	
CN14600	40 Wire, Yazaki	
CN14650	40 Wire, Yazaki	
CN14750	47 Wire, Deutsch	
CN14800	Plug	
CN14850	Connector Terminal Spacer	
CN15050	Deutsch	
CN15400	7 Wire, PD Box	
CN15500	Connector Wire Harness	
CN60050	Speaker Adapter	
CN60100	Adapter	
CN60900	Lamp Socket	



CN14150

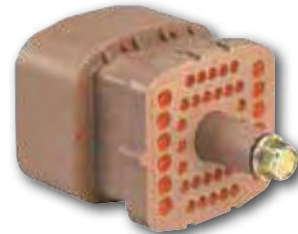

CN14800



BL10850



CN14300



CN14500



CN14350



CN14750



CN14450



CN14400

MISCELLANEOUS CONNECTORS & PLUGS

Table 9-51: Miscellaneous Connectors & Plugs

Part No.	Description
CN15150	Connector Cover
CN15200	Fuse Block
CN42700	22-Way, Weatherpack
CN42900	4-Way, Shroud
CN61250	2-Way, Dummy
CN61300	Plug

ELECTRICAL BLOCKS, STORAGE & TUBING

Fuses
See Page 9-42



CIRCUIT BREAKER BLOCK



Table 9-52: Circuit Breaker Block

Part No.	Description
CC15350	2-Position Circuit Breaker Block

FUSE BLOCKS



BL10250

BL10400

BL10550

BL10750

BL10950

Table 9-53: Fuse Blocks

Part No.	Description
BL10250	ATO Fuse Module, 6-Position Fuse Block
BL10400	2-Position Fuse Block
BL10550	5-Position Fuse Block
BL10750	2-Position Fuse Block
BL10950	Maxi/Mini/Micro Fuse Block
CN60500	4-Position Fuse Block

RELAY BLOCKS



BL10350



BL10450



BL10500



BL10650



BL10800

Table 9-54: Relay Blocks

Part No.	Description
BL10050	Terminal Relay Block
BL10300	High Current Relay Block
BL10350	Relay Mounting Block
BL10450	5-Terminal Relay Block
BL10500	2-Terminal Relay Block
BL10650	10-Terminal Relay Block
BL10800	5-Terminal Relay Block
BL11150	Power Relay Block

STORAGE



BL10600



BL10700

Table 9-55: Storage

Part No.	Description
BL10600	Storage for Blocks
BL10700	Drawer for Blocks

HEAT-GRIP SHRINKABLE TUBING

Heat-Grip Shrinkable Tubing is an adhesive-lined, flexible, thin-wall, heat-shrinkable tubing. It provides one-step electrical insulation and moisture sealing for a wide variety of applications. Thin adhesive lining melts and flows to form a positive environmental seal resistant for the bending of the substrate. Adheres to plastics, rubbers, and metals (including PVC, polyethylene, Neoprene, lead, and steel).

- Thin wall for use on connectors
- Flame and moisture resistant
- Available in black and clear
- Sizes from 0.125" to 1.00"
- Shrink ratio 2:1



Table 9-56: Heat-Grip Shrinkable Tubing

Part No.	Description	Expanded Diameter	Shrink Diameter	Typical Gauge Usage
HT91250	6" Lengths, Black, 5 per bag	1/8"	1/16"	24-18 AWG
HT9125C0	6" Lengths, Clear, 5 per bag	1/8"	1/16"	24-18 AWG
HT91880	6" Lengths, Black, 5 per bag	3/16"	3/32"	20-14 AWG
HT9188C0	6" Lengths, Clear, 5 per bag	3/16"	3/32"	20-14 AWG
HT92500	6" Lengths, Black, 5 per bag	1/4"	1/8"	18-10 AWG
HT9250C0	6" Lengths, Clear, 5 per bag	1/4"	1/8"	18-10 AWG
HT93750	6" Lengths, Black, 5 per bag	3/8"	3/16"	8-6 AWG
HT9375C0	6" Lengths, Clear, 5 per bag	3/8"	3/16"	8-6 AWG
HT95000	6" Lengths, Black, 5 per bag	1/2"	1/4"	6-2 AWG
HT97500	6" Lengths, Black, 5 per bag	3/4"	3/8"	4-2/0 AWG
HT9750C0	6" Lengths, Clear, 5 per bag	3/4"	3/8"	4-2/0 AWG
HT91000	6" Lengths, Black, 5 per bag	1"	1/2"	2-4/0 AWG
HT9100C0	6" Lengths, Clear, 5 per bag	1"	1/2"	2-4/0 AWG

ELECTRICAL RELAYS

RELAYS

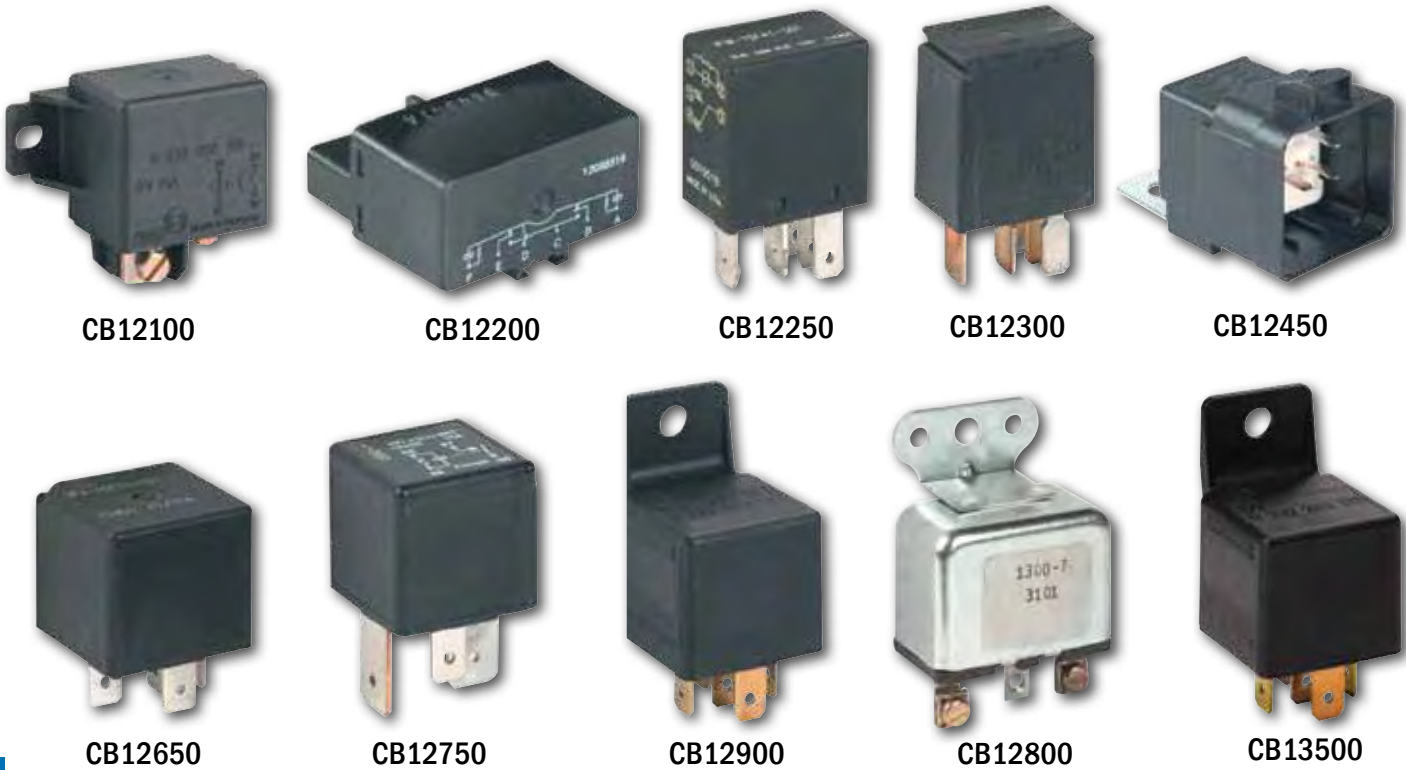

Table 9-57: Electrical Relays

Part No.	Description
CB12100	2 Prong, Power Accessory Relay, 2 Terminals
CB12200	6-Prong
CB12250	5-Prong, Relay, Micro ISO
CB12300	5-Prong, Micro
CB12450	5-Prong, with Cover & Bracket
CB12650	5-Prong, Relay
CB12750	4-Prong, High AMP
CB12800	3-Screw Terminals, 3-Hole Bracket
CB12850	5-Prong, Relay
CB12900	5-Prong, with Bracket
CB13500	5 Prong, Relay, 50amp, with Bracket
CB13550	Relay
CB13600	Switch Relay
CB13650	24-Volt Relay

FLASHERS

ELECTRONIC FLASHERS



EF0212



EF0212RL



CB12150



CB12050



EF0212H



EF0312H

Table 9-58: Electronic Flashers

Part No.	Description	Grote	TruckLite	Peterson	SignalStat
CB12050	2-Prong, 12V with Negative Ground				
CB12150	3-Prong				
CB12700	2-Prong with Mounting Bracket				
TWO-TERMINAL ELECTRONIC FLASHERS					
EF0212	12 Lamp—12V/25 Amp	44810	97210	570	262
EF0212RL	LED Flasher—for use on LED Vehicles. 12 Lamp—12V/25 Amp	44891	-	-	-
EF0212H	Heavy Duty (Meets J1690, 100 Continuous Hours) 12 Lamp—12V/25 Amp	44530	-	-	-
EF0216	16 Lamp—12V/35 Amp	44690	97205	573	242
EF0220	20 Lamp—12V/45 Amp	44710	97207	576	282
THREE-TERMINAL ELECTRONIC FLASHERS					
EF0312	12 Lamp—12V/25 Amp	44820	97211	571	263
EF0312L	LED Flasher—for use on LED Vehicles. 12 Lamp—12V/25 Amp	44890	-	-	-
EF0312H	Heavy Duty (Meets J1690, 100 Continuous Hours) 12 Lamp—12V/25 Amp	44540	-	-	-
EF0316	16 Lamp—12V/35 Amp	44700	97206	574	
EF0320	20 Lamp—12V/45 Amp	44720	97208	577	283

FUSES & FUSE HOLDERS

ATO® BLADE TYPE FUSES

- Voltage Rating: 32V AC/DC
- Interrupting Rating: 1000A @ 32VDC
- Ambient Temp: -40° C to +105° C
- Approvals: UL® listed, CDA certified 3-30A, SAE J1284



Table 9-59: ATO® Blade Type Fuses

Part No.	Description	Amp Rating	Color Code	Qty.
AT01	ATO® Blade Fuse	1	Black	5 each per pkg.
AT02	ATO® Blade Fuse	2	Grey	5 each per pkg.
AT03	ATO® Blade Fuse	3	Violet	5 each per pkg.
AT04	ATO® Blade Fuse	4	Pink	5 each per pkg.
AT05	ATO® Blade Fuse	5	Tan	5 each per pkg.
AT07.5	ATO® Blade Fuse	7.5	Brown	5 each per pkg.
AT010	ATO® Blade Fuse	10	Red	5 each per pkg.
AT015	ATO® Blade Fuse	15	Blue	5 each per pkg.
AT020	ATO® Blade Fuse	20	Yellow	5 each per pkg.
AT025	ATO® Blade Fuse	25	Natural	5 each per pkg.
AT030	ATO® Blade Fuse	30	Green	5 each per pkg.
AT035	ATO® Blade Fuse	35	Blue Green	5 each per pkg.
AT040	ATO® Blade Fuse	40	Orange	5 each per pkg.

MINI® BLADE TYPE FUSES

- Voltage Rating: 32V AC/DC
- Interrupting Rating: 1000A @ 32VDC
- Ambient Temp: -40° C to +125° C
- Approvals: UL® listed, SAE J2077



Table 9-60: Mini® Blade Type Fuses

Part No.	Description	Amp Rating	Color Code	Qty.
M1N2	MINI® Blade Fuse	2	Grey	5 each per pkg.

Part No.	Description	Amp Rating	Color Code	Qty.
M1N3	MINI® Blade Fuse	3	Violet	5 each per pkg.
M1N4	MINI® Blade Fuse	4	Pink	5 each per pkg.
M1N5	MINI® Blade Fuse	5	Tan	5 each per pkg.
M1N7.5	MINI® Blade Fuse	7.5	Brown	5 each per pkg.
M1N10	MINI® Blade Fuse	10	Red	5 each per pkg.
M1N15	MINI® Blade Fuse	15	Blue	5 each per pkg.
M1N20	MINI® Blade Fuse	20	Yellow	5 each per pkg.
M1N25	MINI® Blade Fuse	25	Natural	5 each per pkg.
M1N30	MINI® Blade Fuse	30	Green	5 each per pkg.

MAXI™ BLADE TYPE FUSES

- Voltage Rating: 32V AC/DC
- Interrupting Rating: 1000A @ 32VDC
- Ambient Temp: -40° C to +125° C
- Approvals: UL® listed, SAE J1888



Table 9-61: Maxi™ Blade Type Fuses

Part No.	Description	Amp Rating	Color Code	Qty.
MAX020	MAXI™ Fuse	20	Yellow	5 each per pkg.
MAX025	MAXI™ Fuse	25	Grey	5 each per pkg.
MAX030	MAXI™ Fuse	30	Green	5 each per pkg.
MAX035	MAXI™ Fuse	35	Brown	5 each per pkg.
MAX040	MAXI™ Fuse	40	Orange	5 each per pkg.
MAX050	MAXI™ Fuse	50	Red	5 each per pkg.
MAX060	MAXI™ Fuse	60	Blue	5 each per pkg.
MAX070	MAXI™ Fuse	70	Tan	5 each per pkg.
MAX080	MAXI™ Fuse	80	Natural	5 each per pkg.

FUSE HOLDERS

- Fuse holders for ATO® blade fuses in mini, standard, and maxi sizes up to 60 AMP
- Covered and waterproof holders are included in standard size
- AGC panel mount and universal holders available for glass fuses 1-30 AMP



Table 9-62: Fuse Holders

Part No.	Description
FH1005	Maxi™ Fuse Holder, Black with Cover, 20-60 AMP, # 6 Red Wire
FH1010	ATO® Fuse Holder, Black, No Cover, 1-30 AMP, #12 Yellow Wire
FH1015	Universal AGC (Glass) Fuse Holder, 1-30 AMP, #12-#18 Wire (not included)
FH1020	Mini® Fuse Holder with Cover, 2-20 AMP, #16 Black Wire
FH10250	ATO® Fuse Holder, Yellow, 1-20 AMP, #16 Black Wire
FH1030	AGC (Glass) Fuse Holder, Black, 1-30 AMP for 1/4 x 1-1/4 Fuse, #12 Black Wire
FH1035	AGC (Glass) Panel Mounted Fuse Holder, 1-30 AMP, #12-#18 Wire (not included)
FH1040	ATO® Waterproof Fuse Holder, 1-40 AMP, #12 Wire

FUSE HOLDERS CONTINUED



FH1020

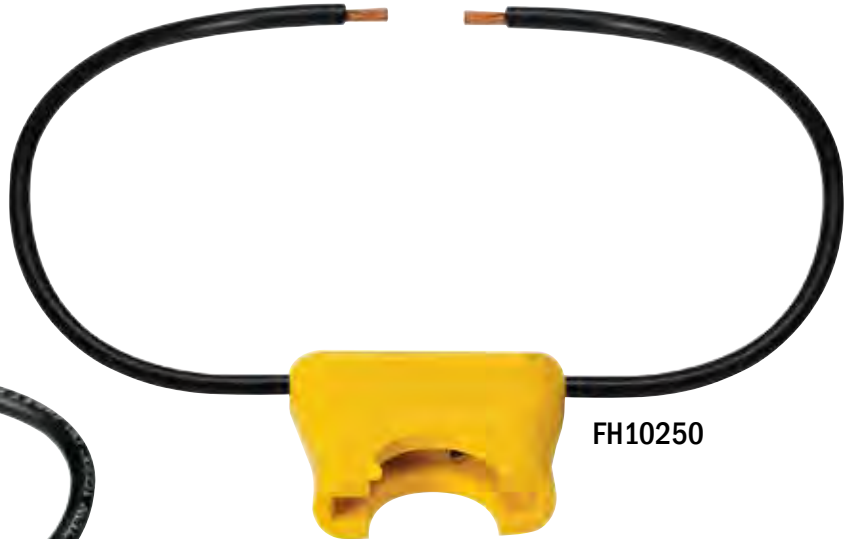

FH10250



FH1030



FH1035



FH1040

LOCKS, PLUGS & SEALS

CABLE SEALS



Table 9-63: Cable Seals

Part No.	Description
CN50100	Seal, Packard
CN50150	Seal, Packard
CN50200	Seal, Packard
CN50250	Seal, Packard 16 AWG
CN50450	Seal, Packard 10-12 AWG 480 Series
CN50500	Seal, Packard 10 AWG 480 Series
CN50600	Seal, Deutsch Size 2
CN50650	Seal, Deutsch Size 3
CN50700	Seal, Deutsch Size 8
CN50800	Seal, Packard 22-24 AWG
CN50900	Seal, Packard 22-24 AWG Cable

CAVITY PLUGS



Table 9-64: Cavity Plugs

Part No.	Description
CN50300	Cavity Plug, Packard
CN50550	Cavity Plug, Deutsch
CN50950	Cavity Plug, Packard Red

TERMINAL LOCKS & LOCKING COMBS

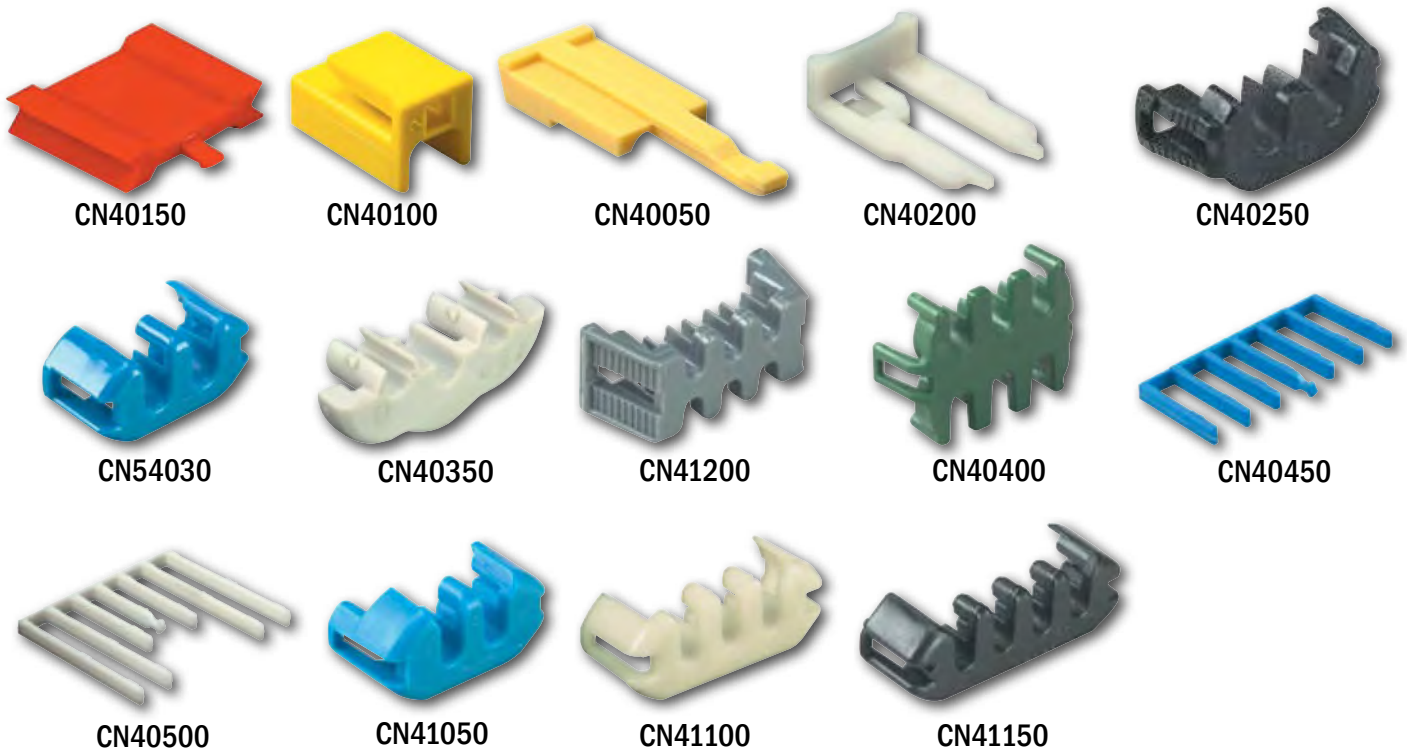
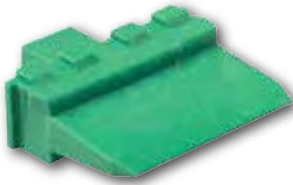

Table 9-65: Terminal Locks & Locking Combs

Part No.	Description
CN40050	Lock, Dill
CN40100	Lock, Fargo
CN40150	Lock, Fargo
CN40200	Lock, Packard Metri-Pack 630 Series
CN40250	Lock, Packard 2 Term Metri-Pack 480 Series
CN40300	Lock, Packard 2 Term Metri-Pack 280 Series
CN40350	Lock, Packard 3 Term
CN40400	Lock, Packard 6 Term Metri-Pack 280 Series
CN40450	Lock, Packard Comb Type
CN40500	Lock, Packard Comb Type
CN40850	Terminal Lock, Packard MP 150 Series 2-Terminal
CN40900	Terminal Lock, Packard MP 150 Series 3-Terminal
CN40950	Terminal Lock, Packard MP 150 Series 4-Terminal
CN41000	Terminal Lock, Packard MP 150 Series 6-Terminal
CN41050	TPA Lock, 2 Pin, Metri-Pack 150 Series, Blue
CN41100	TPA Lock, 3 Pin, Metri-Pack 150 Series, Cream
CN41150	TPA Lock, 4 Pin, Metri-Pack 150 Series, Black
CN41200	TPA Lock, 6 Pin, Metri-Pack 150 Series, Gray

WEDGE LOCKS



CN40750

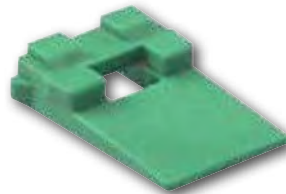

CN40550



CN40650

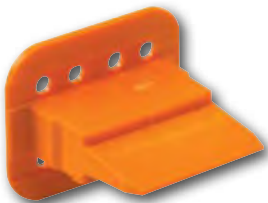

CN40800



CN40600



CN40700

Table 9-66: Wedge Locks

Part No.	Description
CN40550	WedgeLock, Deutsch 2 Cavity Pin
CN40600	WedgeLock, Deutsch 2 Cavity Socket
CN40650	WedgeLock, Deutsch 3 Cavity Pin
CN40700	WedgeLock, Deutsch 3 Cavity Socket
CN40750	WedgeLock, Deutsch 8 Cavity Pin
CN40800	WedgeLock, Deutsch 8 Cavity Socket

SWITCHES



BA40050



BA40100



BA40150



BA40250



BA40200



BA40300



BA40400

ASSORTED SWITCH ACCESSORIES

Table 9-67: Switches – Assorted Switch Accessories

Part No.	Description
BA29050	Reverse Switch
BA29100	Reverse Switch
BA29150	Reverse Switch
BA29200	Reverse Switch
BA31000	Potentiometer Switch
BA31100	Blower Switch
BA40050	Switch Knob, Chrome
BA40100	Cover, Toggle Switch, Keyway Tab Opposite Hinged End
BA40150	Switch Cover
BA40200	Switch Boot
BA40250	Toggle Switch Boot
BA40300	Door Control Plug
BA40400	Wiper/Washer Knob
BL11100	Junction Block
FR10080	Lockout Bracket

HEADLIGHT DIMMER SWITCHES - FOOT ACTIVATED (3 BLADE TERMINALS)



BA2105



BA2110



BA2120

Table 9-68: Switches - Headlight Dimmer

Part No.	Replaces	On Trucks
BA21050	Dimmer Switch, 3 Blade Terminals, Replaces Delco 1997021 and D-800; Motorcraft SW-257	
BA21100	Delco 465A-Z, 471P-Z, 1997002, 1997008, 1997009, 9870014, D-805, U-802; Ford 81A, 11A13532; Mack 1MR-234	Navistar: 70-83; Peterbilt: 70-78
BA21200	AM: 5457282; Delco 1997028, 1997031, 1997035, 1997037, 1997040, 1997043, D-803, D-804, D-808, D-809, D810; GM: 538446, 578005, 1539288; Navistar: 370677C91, 3841892; Jeep: 5461816; Motorcraft SW-259	Autocar: 68-80; Chevrolet: 61-88; Freightliner: 63-67; GMC: 61-88; Navistar: 61-83; KW: 65-67, 72-82, Mack: 70-75; Peterbilt: 79-81; White: 74-80

BATTERY DISCONNECT SWITCHES



BA22050



BA22100/BA22150



BA22200



BA22250



BA22300/BA22350

Table 9-69: Switches - Battery Disconnect

Part No.	Description
BA22050	Battery Disconnect Switch
BA22100	6-36 Volt Systems; (2) 3/8" Dia. Stud Terminals; Die Cast Lever
BA22150	Same As BA2210, Except w/ Silver Laminated Contacts
BA22200	6-36 Volt Systems; (2) 3/8" Dia. Copper Alloy Stud Terminal; Die Cast Lever; O-Rings at Base & Mtg. Stem
BA22250	Battery Disconnect Switch
BA22300	6-36 Volt Systems; (2) 3/8" Dia. Stud Terminal; Chrome Plated Lever; UL® Listed & Labeled; Silver Contacts
BA22350	6-36 Volt Systems; (2) 3/8" Dia. Stud Terminal; Die Cast Lever w/ Dichromate Protective Finish; Silver Contacts; O-Ring Seal In Operating Shaft; Gasket Sealed Terminal Insulator

HEADLAMP SWITCH



Table 9-70: Switches - Head Lamp

Part No.	Description
BA40600	4.5 Ohm Rheostat Dimmer for Panel Lights; Dome Lamp Control in Any of 3 Positions; Internal Circuit Breaker

MIRROR CONTROL SWITCHES



BA4065



BA4070

Table 9-71: Switches - Mirror Control

Part No.	Description
BA4065	Mirror Switch
BA4070	Mirror Switch, Dual Axis, RH

IGNITION STARTER SWITCHES

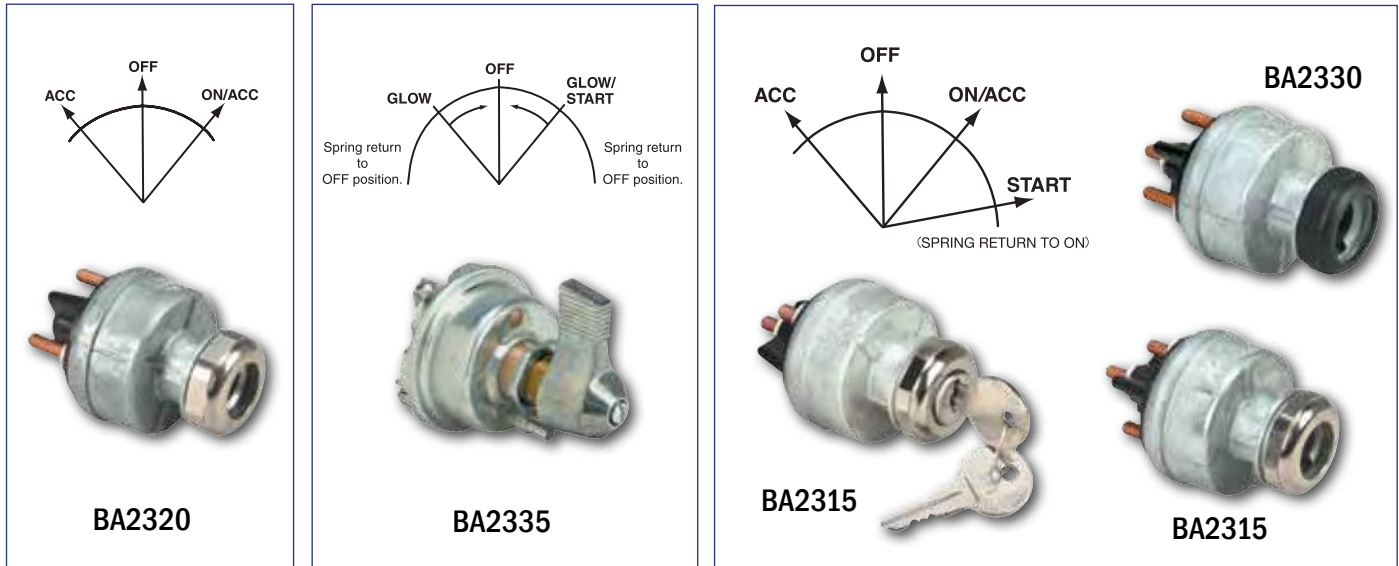
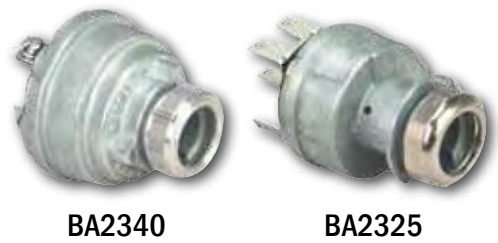

Table 9-72: Switches - Ignition Starter

Part No.	Description
BA23100	4-Position; (4) 10-32 Stud Terminals; Chrome Face Nut
BA23150	4-Position; (4) 10-32 Stud Terminals; Chrome Face Nut; w/ Keys
BA23200	3-Position; (3) 10-32 Stud Terminals; Chrome Mounting Nut
BA23250	11 Blade Terminals, Chrome Mounting Nut
BA23300	4-Position; (4) 10-32 Stud Terminals; Black Face Nut
BA23350	3-Position; (3) Screw Terminals; Die Cast Lever



ELECTRICAL

PUSH BUTTON - DOOR/COURTESY LAMP SWITCHES

Table 9-73: Switches - Push Button Door Switches

Part No.	Description
BA28350	Switch Only, Door
BA28400	Switch Only, Door
BA28600	Switch Only, Door
BA28650	Switch and Wire, Door
BA28800	Switch Only, Door



PUSH BUTTON - DASH SWITCHES

Table 9-74: Switches - Push Button Dash

Part No.	Description
BA28000	Diagnostic
BA28100	Diagnostic ABS
BA28050	A/C Compressor



PUSH BUTTON - MOMENTARY START SWITCHES

Table 9-75: Switches - Push Button Momentary Start

Part No.	Description
BA28850	60A at 12V; Silver Contacts; Housing Rolled Over Insulator to Seal Out Dust and Moisture
BA28900	60A at 12V; Weather and Dust Proof; Plastic Push Button; 2 Screw Terminals
BA28950	Extra Heavy Duty; 2 Screw Terminals
BA29000	18-Gauge Wire Leads, Plasticized Body Sealed against Moisture and Dirt



PUSH BUTTON - MISCELLANEOUS SWITCHES

Table 9-76: Switches - Push Button Miscellaneous

Part No.	Description
BA28450	Clutch
BA28550	Washer

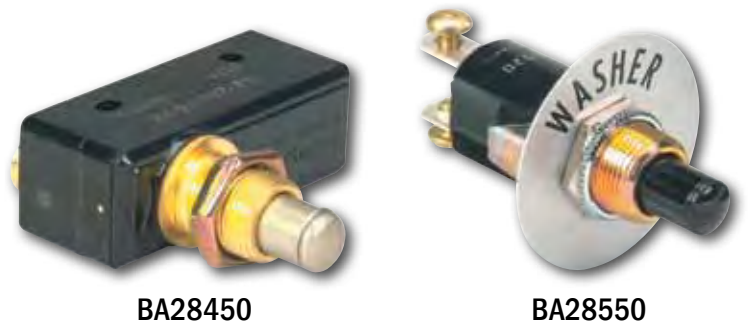

ROCKER SWITCHES

Table 9-77: Switches - Rocker

Part No.	Description
BA10600	HVAC Control
BA11000	HVAC Control
BA30200	Bunk Heater
BA30250	Overhead Lamp
BA30300	On-Off
BA30400	Dome Lamp
BA30450	Refrigerator Fan
BA30500	SPST (On-Off)
BA30550	On-Off
BA30600	On-Off
BA30650	On-Off
BA30700	On-Off



BA10600



BA11000



BA30200



BA30250



BA30300



BA30400



BA30450



BA30500



BA30550



BA30600



BA30650



BA30700

TOGGLE SWITCHES - MISCELLANEOUS

Table 9-78: Switches - Miscellaneous Toggle

Part No.	Description
BA11800	Blower Switch
BA13250	SPST (On-Non-Off)
BA34600	Bunk Heater
BA3465	DPST (On-Off); 4 Terminals
BA34700	SPDT (Mom On-Off-Mom On); 3 Terminals
BA34750	SPDT (Mom On-Neutral-Mom Off); 3 Terminals
BA34800	Toggle
BA34850	SPST (On-Off); with Wires
BA34900	SPST (On-Off); 2 Terminals
BA34950	Toggle



BA11800



BA13250



BA34600

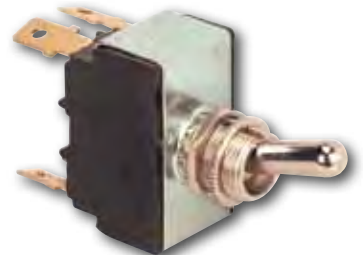

BA34650



BA34700



BA34750



BA34800



BA34850



BA34900



BA34950

TOGGLE SWITCHES - REPLACEMENT W/O BRACKET

Table 9-79: Switches - Freightliner Replacement Switches

Part No.	Description
BA34200	DPST (On-Mom Off); 4 Terminals
BA34250	DPST (On-Off); 4 Terminals
BA34300	SPDT (On-Off-On); 3 Terminals
BA34350	SPST (On-Off); 2 Terminals
BA34400	DPDT (On-Off-On); 6 Terminals



BA34250

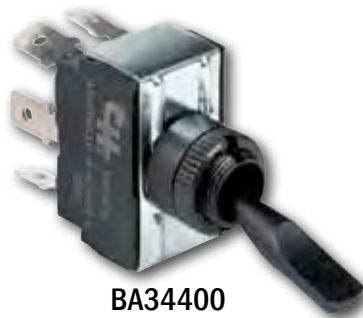

BA34400



BA34350

TOGGLE SWITCHES - REPLACEMENT W/ BRACKET

Table 9-80: Switches - Freightliner Replacement Switches

Part No.	Description
BA33500	SPST (On-Off); 2 Terminals
BA33550	SPDT (On-Off-On); 3 Terminals
BA33650	DPDT (On-Off-On); 6 Terminals
BA3370	DPST (On-Mom Off); 4 Terminals
BA33750	DPDT (Mom On-On-Mom On); 6 Terminals



BA33500

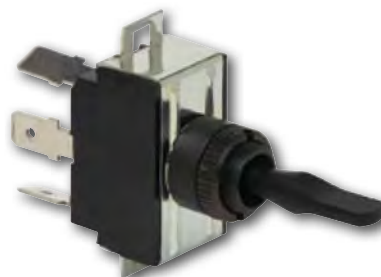

BA33550

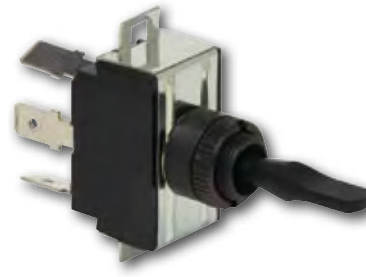

BA33750

FUEL LEVEL SENDERS - ALL MAKES



Fuel Level Sender

Table 9-81: Fuel Level Senders - All Makes

Part No.	Description
FL9220	Fuel Level Sender, Tank O.D. 20"
FL9222	Fuel Level Sender, Tank O.D. 22"
FL9223	Fuel Level Sender, Tank O.D. 23"
FL9224	Fuel Level Sender, Tank O.D. 24"
FL9225	Fuel Level Sender, Tank O.D. 25"
FL9226	Fuel Level Sender, Tank O.D. 26"
FL9227	Fuel Level Sender, Tank O.D. 27"
FL9228	Fuel Level Sender, Tank O.D. 28"
FL9229	Fuel Level Sender, Tank O.D. 29"



Wiper Control

ROTARY WINDSHIELD WIPER CONTROLS

Table 9-82: Rotary Windshield Wiper Controls

Part No.	Description	Replaces	On Trucks
BA5005	2 Motors; w/ 8-Way Male Connector	Navistar: 116536C91	Navistar: 87-96
BA50100	1 Motor; w/ 8-Way Male Connector	Freightliner: A6818240018	Freightliner: 87-96; Peterbilt: 88-93
BA50150	1 Motor; w/ Seven 5" Color-Coded Wire Leads	Freightliner: CHS75600-04	Freightliner: 87-96
BA50250	1 Motor (No Knob); w/ (1) 4-Way Male Connector & (1) 4-Way Female Connector		

SOLENOID SWITCHES

Table 9-83: Switches - Solenoid

Part No.	Description
CD3230	Terminal
CD3235	Terminal, End Mount
CD32400	Terminal



CD3230



CD3240



CD3235

ELECTRICAL

TURN SIGNAL SWITCHES - ALL MAKES

- Exceeds Class A, SAE, QQC, & FMVSS108 specifications
- Heavy-duty construction
- Durable, long-lasting electrical contacts



Table 9-84: Switches - All Makes Turn Signal

Part No.	Description	Replaces
TL10300	4 Wire	Signal Stat: 902
TL10350	7 Wire	Signal Stat: 900, 910
TL10400	7 Wire, Kenworth	Kenworth: K301-182; Signal Stat: 900Y96
TL10450	7 Wire, Navistar (IHC)	Navistar (IHC): 775863C93, 1663595C91, 523848C91; Signal Stat: 900Y114, 900Y206
TL10500	7 Wire, Volvo, White	Volvo/White: 84401-0005; Signal Stat: 900Y129
TL10550	7 Wire, Mack	Mack: 1MR3412P2, 1MR3412, 1MR3440; Signal Stat: 900Y150
TL10600	7 Wire, Ford	Ford: E5HT13B302-AA, E5H-Z13341A; Signal Stat: 900Y170
TL10650	7 Wire, Mack	Mack: 1MR2201P2, 1MR2201P1; Signal Stat: 900Y73
TL37000	All Makes	Ford: FDHT-13B302AB; Signal Stat: 900Y179
TL37050	All Makes	Ford: E9HT13B302AB, E9HZ13341E; Signal Stat: 900Y177



TURN SIGNAL SWITCHES - ALL MAKES

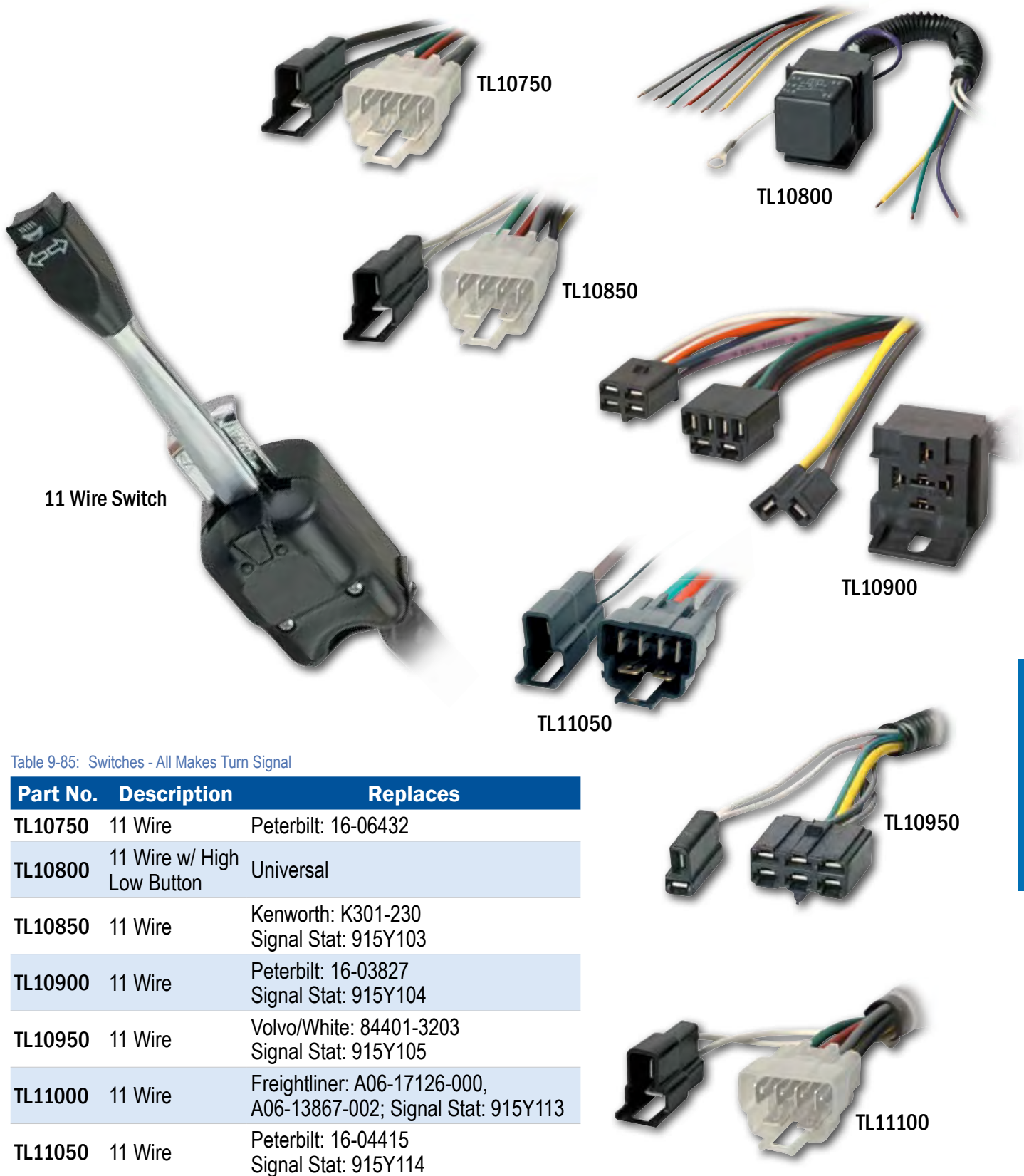

Table 9-85: Switches - All Makes Turn Signal

Part No.	Description	Replaces
TL10750	11 Wire	Peterbilt: 16-06432
TL10800	11 Wire w/ High Low Button	Universal
TL10850	11 Wire	Kenworth: K301-230 Signal Stat: 915Y103
TL10900	11 Wire	Peterbilt: 16-03827 Signal Stat: 915Y104
TL10950	11 Wire	Volvo/White: 84401-3203 Signal Stat: 915Y105
TL11000	11 Wire	Freightliner: A06-17126-000, A06-13867-002; Signal Stat: 915Y113
TL11050	11 Wire	Peterbilt: 16-04415 Signal Stat: 915Y114

ELECTRICAL

TURN SIGNAL SWITCHES - ALL MAKES

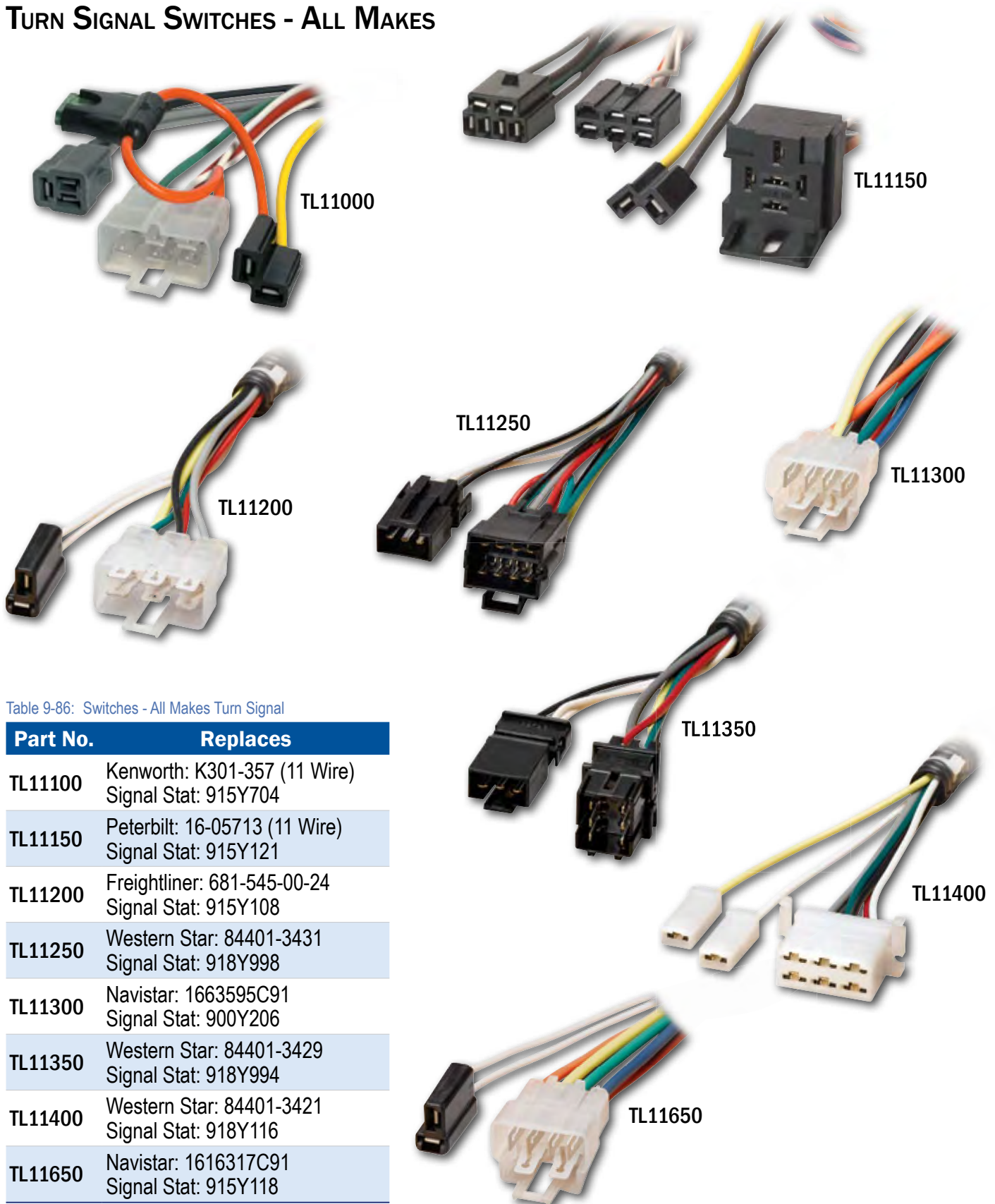
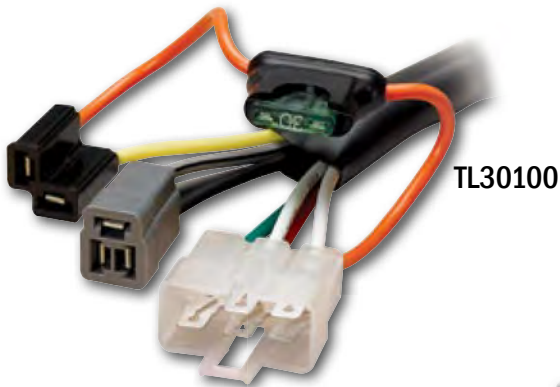
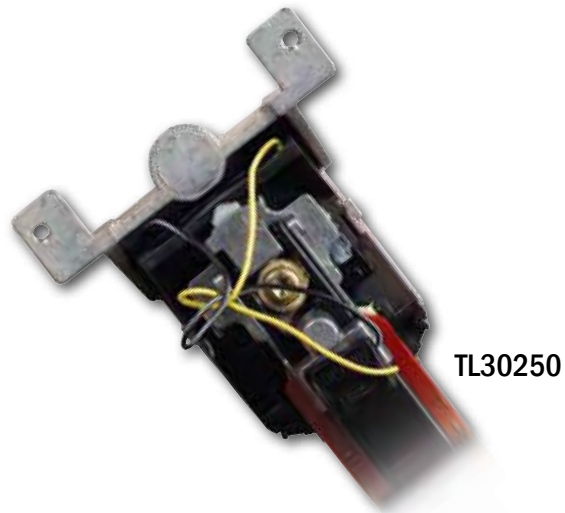

Table 9-86: Switches - All Makes Turn Signal

Part No.	Replaces
TL11100	Kenworth: K301-357 (11 Wire) Signal Stat: 915Y704
TL11150	Peterbilt: 16-05713 (11 Wire) Signal Stat: 915Y121
TL11200	Freightliner: 681-545-00-24 Signal Stat: 915Y108
TL11250	Western Star: 84401-3431 Signal Stat: 918Y998
TL11300	Navistar: 1663595C91 Signal Stat: 900Y206
TL11350	Western Star: 84401-3429 Signal Stat: 918Y994
TL11400	Western Star: 84401-3421 Signal Stat: 918Y116
TL11650	Navistar: 1616317C91 Signal Stat: 915Y118



TL30100



TL30250

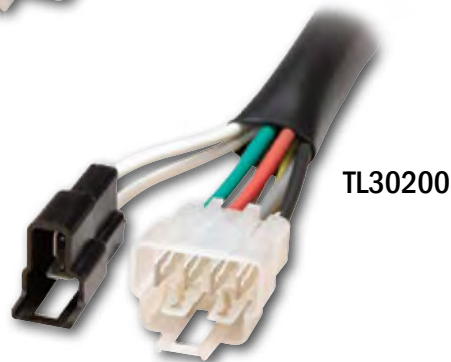

TL30200

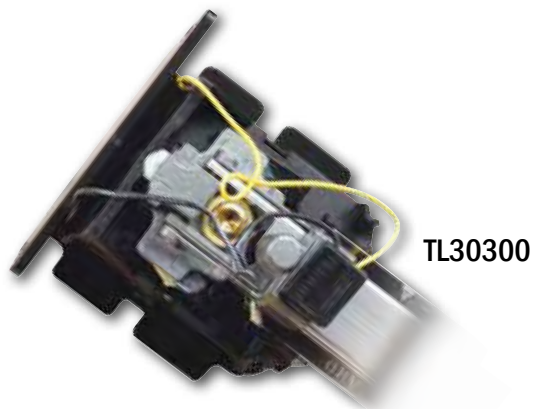

TL30300

TURN SIGNAL SWITCHES - ALL MAKES

Table 9-87: Switches - All Makes Turn Signal

Part No.	Replaces
TL30100	Freightliner: GR01481182 Grote: 01-4811-82
TL30200	Kenworth: K301-295-3
TL30250	Kenworth: 480836
TL30300	Peterbilt: 480827

TURN SIGNAL SWITCHES - MISCELLANEOUS

Table 9-88: Switches - Miscellaneous Turn Signal

Part No.	Replaces
TL10150	Volvo/White: 84401-0021 Signal Stat: 915Y116



TL10150



TL35050

TL35100

TL35200

TL35250

TL35300

TL35350

TURN SIGNAL SWITCHES - ALL MAKES

Table 9-89: Switches - All Makes Turn Signal

Part No.	Replaces
TL35050	Freightliner: A14-13495-000
TL35100	Mack: 1MR574
TL35200	Mack: 1MR575
TL35250	Mack: 1MR571; Signal Stat: 915Y703
TL35300	Mack: 1MR572; Signal Stat: 910Y601
TL35350	Kenworth: 480839
TL35400	Navistar: 480839



TL35400



TL10200



TL10250

TURN SIGNAL SWITCHES - MISCELLANEOUS

Table 9-90: Switches - Miscellaneous Turn Signal Switches

Part No.	Description	Replaces
TL10200	Switch-Turn Signal, Volvo, White	Volvo / White: 84401-0020; Signal Stat: 915Y117
TL10250	Switch-Turn Signal, Peterbilt	Peterbilt: 16-06432; Signal Stat: 915Y124

TERMINALS - HEAT SHRINKABLE

RING TERMINALS

- **Electrolytic Copper:** High-conductivity copper is tin plated and provides low electrical resistance
- **Brazed Seam:** Silver brazed seam can be crimped anywhere and will not split open, even under extreme operating stresses
- **Multiple Grooves:** "V" grooves inside copper barrel securely grip wire strands and prevent pull-out
- **Shrinkable Insulation:** Heat-reactive tubing shrinks to provide superior abrasion protection and additional strain relief
- **Integral Sealant:** Specially formulated adhesive inside tubing permanently bonds tubing to wire insulation and seals out liquids and gases
- **Color Coding:** Insulation is color coded to industry standards – Red (22-18); Blue (16-14); Yellow (12-10); Clear Pink (8)



Table 9-91: Heat Shrinkable Terminals - Ring

Part No.	Description	Stud Size	Qty.
12-10 AWG WIRE SIZE			
HT1008	Bulk, Yellow	8	25 per box
HT1008C0	Clam Shell, Yellow	8	10 per pkg.
HT10100	Bulk, Yellow	10	25 per box
HT1010C0	Clam Shell, Yellow	10	10 per pkg.
HT10250	Bulk, Yellow	1/4"	25 per box
HT1025C	Clam Shell, Yellow	1/4"	10 per pkg.
HT10380	Bulk, Yellow	3/8"	25 per box
HT1038C0	Clam Shell, Yellow	3/8"	10 per pkg.
16-14 AWG WIRE SIZE			
HT14060	Bulk, Blue 6	6	25 per box
HT1406C0	Clam Shell, Blue	6	10 per pkg.
HT14080	Bulk, Blue	8	25 per box
HT1408C0	Clam Shell, Blue	8	10 per pkg.
HT14100	Bulk, Blue	10	25 per box
HT1410C0	Clam Shell, Blue	10	10 per pkg.
HT14250	Bulk, Blue	1/4"	25 per box

ELECTRICAL

Part No.	Description	Stud Size	Qty.
HT1425C0	Clam Shell, Blue	1/4"	10 per pkg.
HT14310	Bulk, Blue	5/16"	25 per box
HT1431C	Clam Shell, Blue	5/16"	10 per pkg.
HT14380	Bulk, Blue	3/8"	25 per box
HT1438C0	Clam Shell, Blue	3/8"	10 per pkg.

22-18 AWG WIRE SIZE

HT18060	Bulk, Red	6	25 per box
HT1806C0	Clam Shell, Red	6	10 per pkg.
HT18080	Bulk, Red	8	25 per box
HT1808C0	Clam Shell, Red	8	10 per pkg.
HT18100	Bulk, Red	10	25 per box
HT1810C0	Clam Shell, Red	10	10 per pkg.
HT18250	Bulk, Red	1/4"	25 per box
HT1825C0	Clam Shell, Red	1/4"	10 per pkg.

SPADE TERMINALS



HT34060

HT34080

HT3410C0

Table 9-92: Heat Shrinkable Terminals - Spade

Part No.	Description	Stud Size	Qty.
12-10 AWG WIRE SIZE			
HT3008	Bulk, Yellow	8	25 per box
HT3008C0	Clam Shell, Yellow	8	10 per pkg.
HT30100	Bulk, Yellow	10	25 per box
HT3010C0	Clam Shell, Yellow	10	10 per pkg.

Part No.	Description	Stud Size	Qty.
HT3025	Bulk, Yellow	1/4"	25 per box
HT3025C0	Clam Shell, Yellow	1/4"	10 per pkg.

16-14 AWG WIRE SIZE

HT34060	Bulk, Blue	6	25 per box
HT3406C0	Clam Shell, Blue	6	10 per pkg.
HT34080	Bulk, Blue	8	25 per box
HT3408C0	Clam Shell, Blue	8	10 per pkg.
HT3410	Bulk, Blue	10	25 per box
HT3410C0	Clam Shell, Blue	10	10 per pkg.

22-18 AWG WIRE SIZE

HT3806	Bulk, Red	6	25 per box
HT3806C0	Clam Shell, Red	6	10 per pkg.
HT38080	Bulk, Red	8	25 per box
HT3808C	Clam Shell, Red	8	10 per pkg.
HT3810C0	Clam Shell, Red	10	10 per pkg.

BULLET TERMINALS



HT66060

HT66070

Table 9-93: Heat Shrinkable Terminals - Bullet

Part No.	Description	Wire Size	Qty.
HT66060	Bulk, Blue, Female	16-14 AWG	25 per box
HT6606C0	Clam Shell, Blue, Female	16-14 AWG	5 per pkg.
HT66070	Bulk, Blue, Male	16-14 AWG	25 per box
HT6607C0	Clam Shell, Blue, Male	16-14 AWG	5 per pkg.
HT6608	Bulk, Red	22-18 AWG	25 per box
HT6608C0	Clam Shell, Red	22-18 AWG	5 per pkg.
HT66090	Bulk, Red	22-18 AWG	25 per box
HT6609C0	Clam Shell, Red	22-18 AWG	5 per pkg.

QUICK DISCONNECT TERMINALS



HT54000



HT54050

Table 9-94: Heat Shrinkable Terminals - Quick Disconnect

Part No.	Description	Wire Size	Qty.
HT5000C0	Clam Shell, Yellow, Female	12-10 AWG	10 per pkg.
HT50050	Bulk, Yellow, Male	12-10 AWG	25 per box
HT5005C	Clam Shell, Yellow, Male	12-10 AWG	10 per pkg.
HT54000	Bulk, Blue, Female	16-14 AWG	25 per box
HT5400C0	Clam Shell, Blue, Female	16-14 AWG	10 per pkg.
HT54050	Bulk, Blue, Male	16-14 AWG	25 per box
HT5405C0	Clam Shell, Blue, Male	16-14 AWG	10 per pkg.
HT58000	Bulk, Red, Female	22-18 AWG	25 per box
HT5800C0	Clam Shell, Red, Female	22-18 AWG	10 per pkg.
HT58050	Bulk, Red, Male	22-18 AWG	25 per box
HT5805C0	Clam Shell, Red, Male	22-18 AWG	10 per pkg.

3 & 4 Way SPLICES



HT4013C0



HT44140

Table 9-95: Heat Shrinkable, 3 & 4 Way Splices

Part No.	Description	Wire Size	Qty.
HT4013C0	3 Way, Clam Shell, Yellow	12-10 AWG	5 per pkg
HT40140	4 Way, Bulk, Yellow	12-10 AWG	25 per box
HT4014C0	4 Way, Clam Shell, Yellow	12-10 AWG	5 per pkg
HT4413C0	3 Way, Clam Shell, Blue	16-14 AWG	5 per pkg
HT44140	4 Way, Bulk, Blue	16-14 AWG	25 per box
HT4414C0	4 Way, Clam Shell, Blue	16-14 AWG	5 per pkg
HT4813C0	3 Way, Clam Shell, Red	22-18 AWG	5 per pkg
HT4814C0	4 Way, Clam Shell, Red	22-18 AWG	5 per pkg

BUTT SPLICES



Table 9-96: Heat Shrinkable Butt Splices

Part No.	Description	Package	Color	Stud-Wire Size
HT2108C0	Heat Shrinkable Butt Splices	Clam Shell (5 per pkg)	Clear Pink	8 AWG
HT21100	Heat Shrinkable Butt Splices	Bulk (25 per box)	Yellow	12-10 AWG
HT2110C0	Heat Shrinkable Butt Splices	Clam Shell (5 per pkg)	Yellow	12-10 AWG
HT21140	Heat Shrinkable Butt Splices	Bulk (25 per box)	Blue	16-14 AWG
HT2114C0	Heat Shrinkable Butt Splices	Clam Shell (5 per pkg)	Blue	16-14 AWG
HT21180	Heat Shrinkable Butt Splices	Bulk (25 per box)	Red	22-18 AWG
HT2118C0	Heat Shrinkable Butt Splices	Clam Shell (5 per pkg)	Red	22-18 AWG

TERMINALS - NYLON INSULATED

RING TERMINALS

- Made from Electrolytic Tough Pitch (ETP) Copper to ensure the highest conductivity
- Each Vinyl Terminal is burr-free and electro-tin plated to resist corrosion
- Serrated "V" groove enables adequate current flow & max. holding power
- Cone-shaped terminal entry enables wire strands to be perfectly crimped w/o wire buildup
- Color-coded for easy identification & crimping – Red (22-18); Blue (16-14); Yellow (12-10)



Table 9-97: Nylon Terminals - Ring

Part No.	Description	Stud Size	Qty.
12-10 AWG WIRE SIZE			
VT1004	Bulk, Butted, Yellow	4	100 per box
VT10060	Bulk, Butted, Yellow	6	100 per box
VT1006C0	Clam Shell, Butted, Yellow	6	10 per pkg.
VT1008C0	Clam Shell, Butted, Yellow	8	10 per pkg.
VT10100	Bulk, Butted, Yellow	10	100 per box
VT1010C0	Clam Shell, Butted, Yellow	10	10 per pkg.
VT10250	Bulk, Butted, Yellow	1/4"	100 per box
VT1025C0	Clam Shell, Butted, Yellow	1/4"	10 per pkg.
VT10310	Bulk, Butted, Yellow	5/16"	100 per box
VT1031C0	Clam Shell, Butted, Yellow	5/16"	10 per pkg.
VT10380	Bulk, Butted, Yellow	3/8"	100 per box
VT1038C0	Clam Shell, Butted, Yellow	3/8"	10 per pkg.
VT10500	Bulk, Butted, Yellow	1/2"	100 per box
VT1050C0	Clam Shell, Butted, Yellow	1/2"	10 per pkg.
16-14 AWG WIRE SIZE			
VT14060	Bulk, Butted, Blue	6	100 per box
VT1406C0	Clam Shell, Butted, Blue	6	10 per pkg.
VT14080	Bulk, Butted, Blue	8	100 per box
VT1408C0	Clam Shell, Butted, Blue	8	10 per pkg.

Part No.	Description	Stud Size	Qty.
VT14100	Bulk, Butted, Blue	10	100 per box
VT1410C0	Clam Shell, Butted, Blue	10	10 per pkg.
VT14250	Bulk, Butted, Blue	1/4"	100 per box
VT1425C0	Clam Shell, Butted, Blue	1/4"	10 per pkg.
VT14310	Bulk, Butted, Blue	5/16"	100 per box
VT1431C0	Clam Shell, Butted, Blue	5/16"	10 per pkg.
VT14380	Bulk, Butted, Blue	3/8"	100 per box
VT1438C0	Clam Shell, Butted, Blue	3/8"	10 per pkg.

22-18 AWG WIRE SIZE

VT18060	Bulk, Butted, Red	6	100 per box
VT1806C0	Clam Shell, Butted, Red	6	10 per pkg.
VT18080	Bulk, Butted, Red	8	100 per box
VT1808C0	Clam Shell, Butted, Red	8	10 per pkg.
VT18100	Bulk, Butted, Red	10	100 per box
VT1810C0	Clam Shell, Butted, Red	10	10 per pkg.
VT18250	Bulk, Butted, Red	1/4"	100 per box
VT1825C0	Clam Shell, Butted, Red	1/4"	10 per pkg.
VT18310	Bulk, Butted, Red	5/16"	100 per box
VT1831C0	Clam Shell, Butted, Red	5/16"	10 per pkg.

SPADE TERMINALS



Table 9-98: Nylon Terminals - Spade

Part No.	Description	Stud Size	Qty.
12-10 AWG WIRE SIZE			
VT3006	Bulk, Butted, Yellow	6	100 per box
VT3006C	Clam Shell, Butted, Yellow	6	10 per pkg.
VT3008C0	Clam Shell, Butted, Yellow	8	10 per pkg.
VT30100	Bulk, Butted, Yellow	10	100 per box
VT3010C0	Clam Shell, Butted, Yellow	10	10 per pkg.
VT3025	Bulk, Butted, Yellow	1/4"	100 per box
VT3025C0	Clam Shell, Butted, Yellow	1/4"	10 per pkg.
16-14 AWG WIRE SIZE			
VT34060	Bulk, Butted, Blue	6	100 per box
VT3406C0	Clam Shell, Butted, Blue	6	10 per pkg.
VT34080	Bulk, Butted, Blue	8	100 per box
VT3408C0	Clam Shell, Butted, Blue	8	10 per pkg.
VT34100	Bulk, Butted, Blue	10	100 per box
VT3410C0	Clam Shell, Butted, Blue	10	10 per pkg.
22-18 AWG WIRE SIZE			
VT3806C0	Clam Shell, Butted, Red	6	10 per pkg.
VT3808	Bulk, Butted, Red	8	100 per box
VT3808C0	Clam Shell, Butted, Red	8	10 per pkg.
VT3810	Bulk, Butted, Red	10	100 per box
VT3810C0	Clam Shell, Butted, Red	10	10 per pkg.

HOOK TERMINALS



Table 9-99: Nylon Terminals - Hook

Part No.	Description	Stud Size	Qty.
12-10 AWG WIRE SIZE			
VT7006	Bulk, Butted, Yellow	6	100 per box
VT7006C0	Clam Shell, Butted, Yellow	6	10 per pkg.
VT7008	Bulk, Butted, Yellow	8	100 per box
VT7008C0	Clam Shell, Butted, Yellow	8	10 per pkg.
VT7010	Bulk, Butted, Yellow	10	100 per box
VT7010C0	Clam Shell, Butted, Yellow	10	10 per pkg.
VT7025	Bulk, Butted, Yellow	1/4"	100 per box
VT7025C	Clam Shell, Butted, Yellow	1/4"	10 per pkg.
16-14 AWG WIRE SIZE			
VT7606	Bulk, Butted, Blue	6	100 per box
VT7606C0	Clam Shell, Butted, Blue	6	10 per pkg.
VT7608	Bulk, Butted, Blue	8	100 per box
VT7608C0	Clam Shell, Butted, Blue	8	10 per pkg.
VT7610	Bulk, Butted, Blue	10	100 per box
VT7610C	Clam Shell, Butted, Blue	10	10 per pkg.
22-14 AWG WIRE SIZE			
VT7806	Bulk, Butted, Red	6	100 per box
VT7806C0	Clam Shell, Butted, Red	6	10 per pkg.
VT7808	Bulk, Butted, Red	8	100 per box
VT7808C	Clam Shell, Butted, Red	8	10 per pkg.
VT7810	Bulk, Butted, Red	10	100 per box
VT7810C	Clam Shell, Butted, Red	10	10 per pkg.

DISCONNECT TERMINALS



VT58000



VT58050

Table 9-100: Nylon Terminals - Disconnect

Part No.	Description	Qty.
12-10 AWG WIRE SIZE		
VT50000	Bulk, Yellow, Female	50 per box
VT5000C0	Clam Shell, Yellow, Female	5 per pkg.
VT50050	Bulk, Yellow, Male	50 per box
VT5005C0	Clam Shell, Yellow, Male	10 per pkg.
16-14 AWG WIRE SIZE		
VT54000	Bulk, Blue, Female	50 per box
VT5400C0	Clam Shell, Blue, Female	5 per pkg.
VT54050	Bulk, Blue, Male	50 per box
VT5405C	Clam Shell, Blue, Male	5 per pkg.
22-18 AWG WIRE SIZE		
VT58000	Bulk, Red, Female	50 per box
VT5800C0	Clam Shell, Red, Female	5 per pkg.
VT58050	Bulk, Red, Male	50 per box
VT5805C0	Clam Shell, Red, Male	5 per pkg.

BULLET TERMINALS



VT6609

Table 9-101: Nylon Terminals - Bullet

Part No.	Description	Qty.
16-14 AWG WIRE SIZE		
VT66060	Bulk, Blue, Female	50 per box
VT6606C0	Clam Shell, Blue, Female	5 per pkg.
VT66070	Bulk, Blue, Male	50 per box
VT6607C0	Clam Shell, Blue, Male	5 per pkg.
22-18 AWG WIRE SIZE		
VT6609	Bulk, Red, Male	50 per box

3 & 4 WAY SPLICES



VT4813C0



VT4813C0

Table 9-102: Nylon, 3 & 4 Way Splices

Part No.	Description	Wire Size	Qty.
VT40130	3 Way, Bulk, Butted, Yellow	12-10 AWG	50 per box
VT4013C0	3 Way, Clam Shell, Butted, Yellow	12-10 AWG	5 per pkg.

Part No.	Description	Wire Size	Qty.
VT4014	4 Way, Bulk, Butted, Yellow	12-10 AWG	50 per box
VT4014C0	4 Way, Clam Shell, Butted, Yellow	12-10 AWG	5 per pkg.
VT4413C0	3 Way, Clam Shell, Butted, Blue	16-14 AWG	5 per pkg.
VT4414	4 Way, Bulk, Butted, Blue	16-14 AWG	50 per box
VT4414C0	4 Way, Clam Shell, Butted, Blue	16-14 AWG	5 per pkg.
VT4813C0	3 Way, Clam Shell, Butted, Red	22-18 AWG	5 per pkg.
VT4814C0	4 Way, Clam Shell, Butted, Red	22-18 AWG	5 per pkg.

BUTT SPLICES

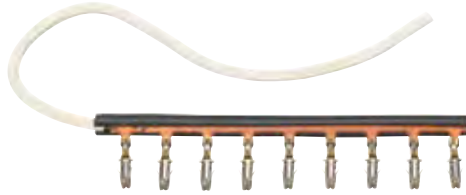

Table 9-103: Nylon Insulated Terminals - Butt Splices

Part No.	Description	Package	Color	Stud-Wire Size
VT2108C0	Butt Splices	Clam Shell (10 per pkg.)	Gray	8 AWG
VT21100	Butt Splices	Bulk (100 per box)	Yellow	12-10 AWG
VT2110C0	Butt Splices	Clam Shell (10 per pkg.)	Yellow	12-10 AWG
VT21140	Butt Splices	Bulk (100 per box)	Blue	16-14 AWG
VT2114C0	Butt Splices	Clam Shell (10 per pkg.)	Blue	16-14 AWG
VT21180	Butt Splices	Bulk (100 per box)	Red	22-18 AWG
VT2118C0	Butt Splices	Clam Shell (10 per pkg.)	Red	22-18 AWG

TERMINAL BLOCK & BUS BARS

BUS BARS



BL10200



BL10150

Table 9-104: Bus Bars

Part No.	Description	Type
CN15450	5 Terminal Bus Bar	Bus Bar
BL10150	Bus Bar, 11 Terminals	Bus Bar
BL10200	Bus Bar, 9 Terminals	Bus Bar

TERMINAL BLOCK

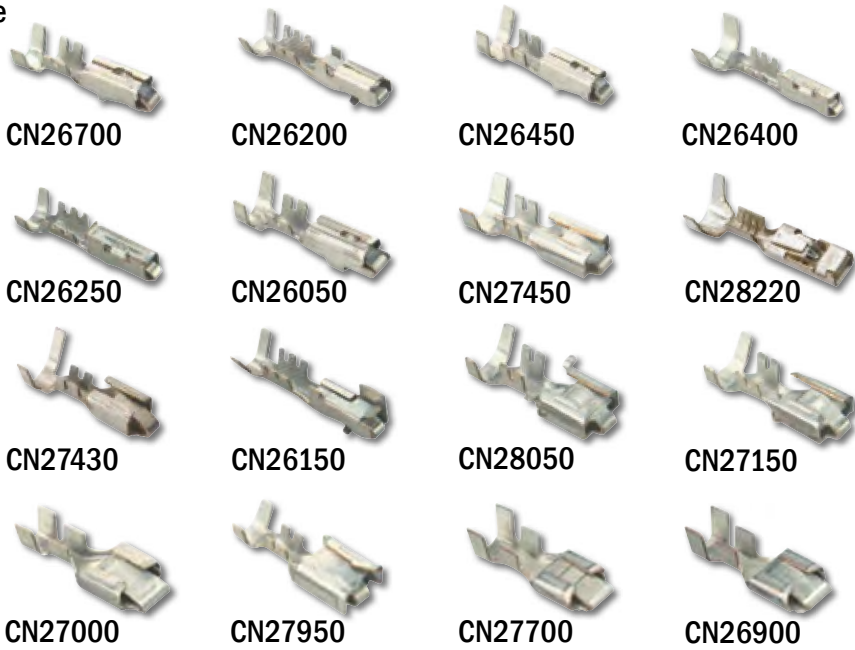

Table 9-105: Terminal Block

Part No.	Description
BL10100	Terminal Block

TERMINAL ENDS

Female



Misc. Terminal Ends



Male



SPADE/SLIDE

Table 9-106: Terminal Ends - Spade/Slide

Part No.	Description	Mates With	Type
FEMALE			
CN26200	16-18 Gauge		Packard 150 Series
CN26250	16-18 Gauge		Packard 150 Series
CN26300	20-22 Gauge		Packard 150 Series
CN26350	24 Gauge		Packard 150 Series
CN26400	16-20 Gauge		Packard 150 Series, Sealed

Part No.	Description	Mates With	Type
CN26410	20-22 Gauge	CN29960	Packard 150 Series, Sealed
CN26160	16-18 Gauge		Packard 150.2 Series
CN26150	20-22 Gauge		Packard 150.2 Series
CN26450	12 Gauge	CN29550	Packard 280 Series, Sealed
CN26500	12-14 Gauge	CN25650	Packard 280 Series, Sealed
CN26550	16-18 Gauge	CN29650	Packard 280 Series, Sealed
CN26600	20-22 Gauge	CN29700	Packard 280 Series, Sealed
CN26030	10-12 Gauge	CN29550	Packard 280 Series, Tangleless
CN26050	12-14 Gauge	CN25660	Packard 280 Series, Tangleless
CN26100	16-18 Gauge	CN25320	Packard 280 Series, Tangleless
CN26650	10-12 Gauge	CN29750	Packard 280 Series, Unsealed
CN26700	12-14 Gauge	CN29800	Packard 280 Series, Unsealed
CN26750	14-16 Gauge	CN29850	Packard 280 Series, Unsealed
CN26800	18-20 Gauge	CN29900	Packard 280 Series, Unsealed
CN27430	14-16 Gauge	CN29520	Packard 480 Series, Sealed
CN27450	10 Gauge	CN29250	Packard 480 Series, Sealed
CN27500	12 Gauge	CN29300	Packard 480 Series, Sealed
CN27550	14-16 Gauge	CN29350	Packard 480 Series, Sealed
CN27570	14-16 Gauge, Brass	CN29350	Packard 480 Series, Sealed
CN27600	18 Gauge	CN29400	Packard 480 Series, Sealed
CN27650	20-22 Gauge	CN29450	Packard 480 Series, Sealed
CN27700	10 Gauge	CN20950	Packard 56 Series, Unsealed
CN27750	12 Gauge, w/ Nib	CN21000	Packard 56 Series, Unsealed
CN27760	14-16 Gauge	CN21050	Packard 56 Series, Unsealed
CN26950	12 Gauge	CN21000	Packard 56 Series, Unsealed
CN26900	12 Gauge, w/ Rib	CN20950 or CN21000	Packard 56 Series, Unsealed
CN26960	14-16 Gauge	CN21050	Packard 56 Series, Unsealed
CN27000	14-16 Gauge	CN21050	Packard 56 Series, Unsealed
CN27050	14-16 Gauge (2 Each)		Packard 56 Series, Unsealed
CN27800	14-16 Gauge, w/ Nib	CN21050	Packard 56 Series, Unsealed
CN27100	14-16 Gauge, w/ Nib (2 each)		Packard 56 Series, Unsealed
CN27810	18-20 Gauge	CN21100	Packard 56 Series, Unsealed
CN27850	18-20 Gauge, w/ Nib	CN21100	Packard 56 Series, Unsealed
CN27150	10-12 Gauge	CN29050	Packard 630 Series, Unsealed
CN27400	10-12 Gauge (2 each)		Packard 630 Series, Unsealed
CN27200	12 Gauge	CN29100	Packard 630 Series, Unsealed

Part No.	Description	Mates With	Type
CN27250	14-16 Gauge	CN29150	Packard 630 Series, Unsealed
CN27300	18-20 Gauge	CN29200	Packard 630 Series, Unsealed
CN27350	20-22 Gauge		Packard 630 Series, Unsealed
CN28000	10-12 Gauge	CN29050	Packard 630 Series, Unsealed
CN27950	14-16 Gauge	CN29150	Packard 630 Series, Unsealed
CN27900	18 Gauge	CN29200	Packard 630 Series, Unsealed
CN28050	10-12 Gauge	BL10800	Packard 630 Spec. Series, Unsealed
CN28100	14-16 Gauge	BL10800	Packard 630 Spec. Series, Unsealed
CN28150	18-20 Gauge	BL10800	Packard 630 Spec. Series, Unsealed
CN28210	12-14 Gauge	CN29980	Packard GT 280 Series, Sealed
CN28220	16-18 Gauge	CN29990	Packard GT 280 Series, Sealed

MALE

CN20250	14 Gauge		Packard 100 Series, Straight, Micro-Pack
CN20300	16-18 Gauge		
CN20350	20-22 Gauge		
CN29980	12-14 Gauge	CN28210	Packard 150 Series, Sealed
CN29990	16-18 Gauge	CN28220	
CN29960	18-20 Gauge	CN26400	
CN29970	20-22 Gauge	CN26410	
CN29550	10-12 Gauge	CN26450, CN26030	Packard 280 Series, Sealed
CN25650	12-14 Gauge	CN26500, CN26050	
CN29650	16-18 Gauge	CN26550 or CN26100	
CN29700	20-22 Gauge	CN26600, CN26110	
CN29750	10 Gauge	CN26650	Packard 280 Series, Unsealed
CN29800	12 Gauge	CN26700	
CN29850	14-16 Gauge	CN26750	
CN29900	18 Gauge	CN26800, CN28610	
CN29950	20-22 Gauge	CN26850	
CN29520	10 Gauge	CN27430	Packard 480 Series, Sealed
CN29500	10 Gauge	CN27420	
CN29250	10 Gauge	CN27450 or CN27500	Packard 480 Series, Unsealed
CN29300	12 Gauge	CN27500	

Part No.	Description	Mates With	Type
CN29350	14-16 Gauge	CN27550, CN27560, CN27570	
CN29400	18 Gauge	CN27600 or CN27650	
CN29450	20-22 Gauge	CN27650	
CN20950	10-12 Gauge	CN26900, CN26950	Packard 56 Series, Unsealed
CN21000	12 Gauge	CN26900, CN26950	
CN21050	14-16 Gauge	CN26960, CN27760, CN27000, CN27800, CN20800	
CN21100	18-20 Gauge	CN26970, CN27810, CN27820, CN27850, CN20800	
CN29050	10 Gauge	CN27150 or CN28000	Packard 630 Series, Unsealed
CN29100	12 Gauge	CN27200	
CN29150	14-16 Gauge	CN29250 or CN27950	
CN29200	18-20 Gauge	CN27300, CN27310, CN27900	

MISCELLANEOUS

CN20450	16-20 Gauge		Amp Junior Power Timer
CN20600	16-20+ Gauge		Amp Junior Power Timer
CN20050	Bullet, .180 12-14 Gauge		
CN21210	Female 480 Series Special 12-14 Gauge		
CN21160	Female Lamp Socket		
CN21180	Female Pack-Con III		
CN21150	Molex, 16 AWG		
CN20800	Quick Connect, Amp 14-18 Gauge		
CN20750	Quick Connect, Large		
CN20700	Quick Connect, Small		
CN20150	Wedge, Amp		
CN20200	Wedge, Packard 18-20 Gauge (2 each)		
CN20900	Whitaker, Mates w/ 1/4 Blade Terminal		

SLEEVES, SOCKETS & PINS



CN24700



CN24050



CN24100



CN24300



CN23150



CN24200



CN25450



CN25050



CN2(*+\$)



CN25320



CN25400



CN25500



CN24450

Table 9-107: Sleeves, Sockets & Pins

Part No.	Description	Mates With
AMP		
CN24150	Amp Mate-N-Lok, 10-12 Gauge	
CN24200	Amp Mate-N-Lok, 14 Gauge	
CN24250	Amp Mate-N-Lok, 16-20 Gauge	
CN25050	Amp Pin, 18-20 Gauge	
CN24100	Amp Sleeve/Socket, 14-20 Gauge	
CN24050	Amp Sleeve/Socket, 16-18 Gauge	
CARDELL PIN		
CN25400	Cardell Pin	
CN25460	Cardell Pin, 10-12 Gauge	
CN25450	Cardell Pin, 14-16 Gauge	
CN25470	Cardell Pin, 18-20 Gauge	
CN24810	Cardell Sleeve, 10-12 Gauge	
CN24750	Cardell Sleeve, Large	

Part No.	Description	Mates With
CN24700	Cardell Sleeve, Larger Gauge	
CN24800	Cardell Sleeve, Medium, 14-16 Gauge	

DEUTSCH SOCKET

CN24450	6 Gauge, Use with 30 Series	CN25100
CN24500	8-10 Gauge, Use with 30 Series	CN25150
CN24550	12-14 Gauge, Use with 30 Series	CN25200
CN24600	14-16 Gauge, Use with 10 or 30 Series	CN25250
CN24650	16-18 Gauge, Use with 10 or 30 Series	CN25300
CN24660	20-24 Gauge	CN25310
CN25200	12-14 Gauge, Use with 30 Series	CN24550
CN25350	12-14 Gauge, Use with HD 10 Series	
CN25250	14-16 Gauge, Use with 10 or 30 Series	CN24600
CN25300	16-18 Gauge, Use with 10 or 30 Series	CN24650
CN25100	6 Gauge, Use with 30 Series	CN24450
CN25150	8-10 Gauge, Use with 30 Series	CN24500

DEUTSCH SOCKET, GOLD PINNING

CN25210	12-14 Gauge	CN24560
CN25260	14-16 Gauge	CN24610
CN25320	16-18 Gauge	CN24670
CN25330	20-24 Gauge	CN24680

DEUTSCH SOCKET, GOLD PLATING

CN24560	12-14 Gauge	CN25210
CN24610	14-16 Gauge	CN25260
CN24670	16-18 Gauge	CN25320
CN24680	20-24 Gauge	CN25330

PACKARD

CN25500	Packard Weatherpack I-Pin, 12 Gauge	
CN25550	Packard Weatherpack I-Pin, 14-16 Gauge	
CN25600	Packard Weatherpack I-Pin, 18-20 Gauge	
CN24300	Packard Sleeve, Weatherpack 12 Gauge	
CN24350	Packard Sleeve, Weatherpack 14-16 Gauge	
CN24400	Packard Sleeve, Weatherpack 18-20 Gauge	

TERMINAL ENDS FOR FUSES & RELAYS

Table 9-108: Terminal Ends for Fuses and Relays

Part No.	Description	Type
CN43100	40 Way Terminal End, Female	40 Way
CN43050	40 Way Terminal End, Male	41 Way
CN14900	40 Way Terminal End, Male	42 Way
CN23350	16 Gauge	Cardell
CN23300	10-12 Gauge	Cardell
CN23400	18-20 Gauge (Small)	Cardell
CN23450	8-10 Gauge (Large)	Cardell
CN23150	10-12 Gauge	Dill
CN23200	14-16 Gauge	Dill
CN23250	18-20 Gauge	Dill
CN30400	Terminals	Flachstecker
CN30500	Terminals	Flachstecker
CN30550	Terminals	Flachstecker
CN23100	14-16 Gauge	Maxi Fuses
CN30650	14-16 Gauge	MCP 2.8
CN22050	14-16 Gauge	Micro Relays (Large)
CN22150	18-20 Gauge	Micro Relays (Large)
CN22200	22-24 Gauge (2 each)	Micro Relays (Large)
CN22300	18-20 Gauge	Micro Relays (Small)
CN22350	22-24 Gauge, Fuse Module	Micro Relays (Small)
CN22900	10-12 Gauge	Mini Fuses
CN22950	14 Gauge (2 each)	Mini Fuses
CN22800	14-16 Gauge	Mini Fuses
CN23000	18 Gauge (2 each)	Mini Fuses
CN22850	18-20 Gauge	Mini Fuses
CN23850	14-16 Gauge	Terminal
CN30250	Junior Power	Timer
CN30150	Junior Power	Timer



CN23350



CN23100



CN23450



CN22900



CN23150



CN23550



CN22550



CN23500



CN22150



CN22300

Part No.	Description	Type
CN23550	10-12 Gauge	United Technologies
CN23500	12-14 Gauge	United Technologies
CN22650	10-12 Gauge	United Technologies
CN22600	14-16 Gauge	United Technologies
CN22700	14-16 Gauge (2 each)	United Technologies
CN22550	18-20 Gauge	United Technologies
CN60450	Terminal	United Technologies
CN30100	Terminal	United Technologies

TOOLS

CABLE TIE TOOLS

- Specifically developed for maximum ergonomic and performance values
- Combine reduced hand effort and durable components to ensure efficient assembly and a longer life cycle
- Low-friction bearing mechanisms reduce hand effort and provide a smooth stroke



CM11200



CM11350



CM11250



CM11300

Table 9-109: Cable Tie Tools

Part No.	Description
CM11200	Cable Tie Tool, Mark 9, 50-255 lbs Ties
CM11250	Cable Tie Twist Tool, 18-50 lbs Ties
CM11300	Cable Tie Twist Tool, 120-150 lbs Ties
CM11350	Cable Tie Tool, 18-50 lbs Ties
CM11400	Cable Tie Tool, Stainless Ties

DEUTSCH CONNECTOR TOOLS

- For use with Deutsch pins & sockets



Terminal Ends
See Page 9-76



Table 9-110: Deutsch Connector Tools

Part No.	Description
CN60400	Packard Extraction
CT10050	Crimp Tool, 12-20 GA, Solid Contact
CT10200	56 Series Crimper, Splices
CT10250	480 M/P Crimper
CT10350	Packard Crimper

MISCELLANEOUS TOOLS

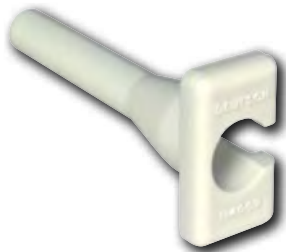

RT10050



RT10010



RT10150



RT10200

Table 9-111: Miscellaneous Tools

Part No.	Description
RT10050	Deutsch Connector Removal Tool, 6ga
RT10100	Deutsch Connector Removal Tool, 8-10ga
RT10150	Deutsch Connector Removal Tool, 12ga
RT10200	Deutsch Connector Removal Tool, 14-16ga

WIRE

PRIMARY WIRE

- Available in a variety of lengths
- Pure copper conductors ensure excellent conductivity
- Insulated with heavy-duty vinyl to resist acid, oil, flame, & moisture
- Standard package 1 each



Table 9-113: Primary Wire

Part No.	Description
8 AWG SPOOL	
PB0108BK0	Spool, 100', Black
PB0108BL0	Spool, 100', Blue
PB0108R0	Spool, 100', Red
PB0108W0	Spool, 100', White

12 AWG SPOOL

PB0110BK0	Spool, 100', Black
PB0110BL0	Spool, 100', Blue
PB0110GR0	Spool, 100', Green
PB0110R0	Spool, 100', Red
PB0110W0	Spool, 100', White
PB0110Y0	Spool, 100', Yellow

12 AWG SPOOL

PB0112BK0	Spool, 100', Black
PB0112BL0	Spool, 100', Blue
PB0112BR0	Spool, 100', Brown
PB0112GR0	Spool, 100', Green
PB0112R0	Spool, 100', Red
PB0112W0	Spool, 100', White

Part No.	Description
14 AWG SPOOL	
PB0114BK0	Spool, 100', Black
PB0114BL0	Spool, 100', Blue
PB0114BR0	Spool, 100', Brown
PB0114GR0	Spool, 100', Green
PB0114R0	Spool, 100', Red
PB0114W0	Spool, 100', White
PB0114Y0	Spool, 100', Yellow

16 AWG SPOOL

PB0116BK0	Spool, 100', Black
PB0116BL0	Spool, 100', Blue
PB0116BR0	Spool, 100', Brown
PB0116GR0	Spool, 100', Green
PB0116R0	Spool, 100', Red
PB0116W0	Spool, 100', White
PB0116Y0	Spool, 100', Yellow

18 AWG SPOOL

PB0118BK0	Spool, 100', Black
PB0118BL0	Spool, 100', Blue

Part No.	Description
PB0118GR0	Spool, 100', Green
PB0118R0	Spool, 100', Red
PB0118W0	Spool, 100', White
PB0118Y0	Spool, 100', Yellow

8 AWG SMALL SPOOL

PW0108BK0	Small Spool, 5'/Coil, Black
PW0108BL0	Small Spool, 5'/Coil, Blue
PW0108BR0	Small Spool, 5'/Coil, Brown
PW0108GR0	Small Spool, 5'/Coil, Green
PW0108R0	Small Spool, 5'/Coil, Red
PW0108W0	Small Spool, 5'/Coil, White
PW0108Y0	Small Spool, 5'/Coil, Yellow

10 AWG SMALL SPOOL

PW0110BK0	Small Spool, 8'/Coil, Black
PW0110BL0	Small Spool, 8'/Coil, Blue
PW0110BR0	Small Spool, 8'/Coil, Brown
PW0110GR0	Small Spool, 8'/Coil, Green
PW0110R0	Small Spool, 8'/Coil, Red
PW0110Y0	Small Spool, 8'/Coil, Yellow

12 AWG SMALL SPOOL

PW0112BK0	Small Spool, 12'/Coil, Black
PW0112BL0	Small Spool, 12'/Coil, Blue
PW0112GR0	Small Spool, 12'/Coil, Green
PW0112R0	Small Spool, 12'/Coil, Red
PW0112W0	Small Spool, 12'/Coil, White
PW0112Y0	Small Spool, 12'/Coil, Yellow

14 AWG SMALL SPOOL

PW0114BK0	Small Spool, 20'/Coil, Black
PW0114BL0	Small Spool, 20'/Coil, Blue
PW0114BR0	Small Spool, 20'/Coil, Brown
PW0114GR0	Small Spool, 20'/Coil, Green
PW0114R0	Small Spool, 20'/Coil, Red
PW0114W0	Small Spool, 20'/Coil, White
PW0114Y0	Small Spool, 20'/Coil, Yellow

Part No.	Description
----------	-------------

16 AWG SMALL SPOOL

PW0116BK0	Small Spool, 28'/Coil, Black
PW0116BL0	Small Spool, 28'/Coil, Blue
PW0116BR0	Small Spool, 28'/Coil, Brown
PW0116GR0	Small Spool, 28'/Coil, Green
PW0116R0	Small Spool, 28'/Coil, Red
PW0116W0	Small Spool, 28'/Coil, White
PW0116Y0	Small Spool, 28'/Coil, Yellow

18 AWG SMALL SPOOL

PW0118BK0	Small Spool, 40'/Coil, Black
PW0118BL0	Small Spool, 40'/Coil, Blue
PW0118BR0	Small Spool, 40'/Coil, Brown
PW0118GR0	Small Spool, 40'/Coil, Green
PW0118W0	Small Spool, 40'/Coil, White

VENDOR CROSS REFERENCE

VENDOR CROSS REFERENCE

Table 9-112: Vendor Cross Reference

Vendor Part No.	Inline Part No.
AFL	
001-0376	CN25400
001-0421	CN24800
001-0647	CN23300
001-0694	CN23450
001-1041	CN22900
001-1043	CN22800
001-1044	CN22850
001-1155	CN24450
001-1314	CN22700
001-1318	CN22600
001-1336	CN22550
001-1432	CN24700
001-1433	CN24750
001-1435	CN25450
001-1536	CN20150
001-1603	CN23550
001-1674	CN23100
001-1808	CN22300
001-1809	CN22050
001-1811	CN23400
001-1812	CN22150
001-1827	CN23500
002-4450	BL10250
002-4622	BL10950
002-4624	BL10300
002-5376	CN14300
AM	
5457282	BA21200

Vendor Part No.	Inline Part No.
AMP	
1-480585-0	CN13550
350551-1	CN24100
350874-3	CN24200
350923-3	CN24150
61366-1	CN25050
66101-3	CN24050
927768-3	CN20150
927779-1	CN20450
BORG WARNER	
1039-07732-10	CB12100
BOSCH	
0-332-002-150	CB12850
0-332-002-156	CB12250
0-332-204-132	CB12900
0-332-207-307-315	CN23300
0-332-209-150	CN23350
CARDELL	
46206	BA34900
46207	BA21200
COLE HERSEE	
5582	BA28800
7762	BA50100
9075	BA28900
75600	BA22100
90030	BA22150
2484	CC23100
2484-16	CC23150
30055-10	CC23200
30055-15	CC23250
30055-20	CC23300
30055-25	CC23400
30055-30	CC23080
30055-8	CC22150

Vendor Part No.	Inline Part No.
30056-10	CC22200
30056-15	CC22250
30056-20	CC22300
30056-25	CC22400
30056-30	CC22300
30056-40	CC22400
30056-8	CC22080
30409-10	CC15100
30409-15	CC15150
30409-20	CC15200
30409-25	CC15250
30409-30	CC15300
55017	BA34700
55021	BA34750
55071	BA34850
5582-10	BA34350
59024-12	BA34350
59024-12	BA34300
59024-14	BA34400
59024-15	BA34400
59024-15	BA34200
59024-16	BA33500
59024-33	BA33550
59024-35	BA33650
59024-36	BA33750
59024-37	BA3370
59024-38	BA50150
71092	BA40600
75600-04	BA23350
75600-07	BA22300
75601-02	BA22350
9245	BA29000
95033	CC22050
956-6309	CC22080
M284-02	CC22150
M608	CC22200

Vendor Part No.	Inline Part No.
COOPER BUSSMANN	
121B05-00M	CC22250
121B08-00M	CC22300
121B10-00M	CC22400
121B25-00M	CC24200
121B30-00M	CC24300
121B40-00M	CC24400
121H10-00M	CC12050
121H15-00M	CC11050
121H20-00M	CC12080
121H30-00M	CC11080
121H40-00M	CC12100
19105-03M	CC11100
19105-04M	CC12150
19108-03M	CC11150
19108-04M	CC14200
19110-03M	CC14250
19110-04M	CC12250
19115-03M	CC11250
19115-04M	CC14300
19120-01M	CC12300
19120-04M	CC11300
19125-01M	CC14350
19125-03M	CC14400
19125-04M	CC13050
19130-03M	CC13100
19130-04M	CC13150
19135-01M	CC13200
19140-01M	CC13250
19205-02M	CC13300
19208-02M	CC13350
19210-02M	CC13400
19215-02M	CC13150
19220-02M	CC13200
19225-02M	CC13250
19230-02M	CC13300

Vendor Part No.	Inline Part No.
19235-02M	CC13350
19240-02M	CC13400
19250-02M	54-140

DELCO

1114534	54-140
1997002	BA21100
1997008	BA21100
1997009	BA21100
1997021	BA21050
1997028	BA21200
1997031	BA21200
1997035	BA21200
1997037	BA21200
1997040	BA21200
1997043	BA21200
199870014	BA21100
465A-Z	BA21100
471P-Z	BA21100
D-800	BA21050
D-803	BA21200
D-804	BA21200
D-805	BA21100
D-808	BA21200
D-809	BA21200
D810	BA21200
U-802	BA21100

DEUTSCH

0460-202-16141	CN25300
0460-204-0490	CN25100
0460-204-08141	CN25150
0460-204-12141	CN25200
0460-215-16141	CN25250
0460-220-1231	CN25350
0462-201-16141	CN24650
0462-203-04141	CN24450
0462-203-08141	CN24500
0462-203-12141	CN24550

Vendor Part No.	Inline Part No.
0462-209-16141	CN24600
1010-002-0306	CN50650
1010-009-0206	CN50600
114017	CN50550
8N1532-24-7P	CN13400
AEC40SA-P005	CN14550
DTHD04-1-12P	CN10400
DTHD04-1-4P	CN10300
DTHD04-1-8P	CN10350
DTHD06-1-12S	CN10150
DTHD06-1-4S	CN10050
DTHD06-1-8S	CN10100
HD34-18-14PN	CN13700
HD34-18-14SN	CN13800
HD34-24-31PT	CN14500
HD36-18-14SN-059	CN13750
HD36-24-31ST	CN14350
HDP24-24-47PE	CN14750
W2P	CN40550
W2S	CN40600
W3P	CN40650
W3S	CN40700
W8P	CN40750
W8S	CN40800

DILL

53132	CN12450
59011	CN40150
59021	BL10350
59056	CN40050
59099	CN40100
59105	BL10400
59216	BL10550
226-00-02	CN11550
23432	CN23150
23433	CN23200
23434	CN23250
6666	CN10250

Vendor Part No.	Inline Part No.
FASCO	
1110-0542	CC23080
1110-0544	CC23100
1110-0546	CC23150
1110-0548	CC23200
1110-0550	CC23250
1110-0552	CC23300
1110-0943	CC23050
1110-1044	CC23400
FORD	
11A13532	BA21100
E5HT13B302-AA	TL10600
E5HZ13341A	TL10600
FREIGHTLINER	
A06-13867-002	TL11000
A06-17126-111	TL11000
A6818240018	BA50100
CHS75600-04	BA50150
GM	
538446	BA21200
578005	BA21200
GROTE	
44530	EF0212H
44540	EF0312H
44690	44690
44700	EF0316
44710	44710
44720	EF0320
44810	EF0212
44820	EF0312
44890	EF0312L
44891	EF0212RL
48072	48072
48282	48282

Vendor Part No.	Inline Part No.
HELLA	
4RD931410-08	CB12450
4RD931524-02	CB12300
HELLERMAN TYTON	
12-0375M4	CTB3520
BT100H1RC2	CTB3520
T50I2C2	CT04313
T50I9C2	CT04312
T50LOC2	CT05317
T50L9C2	CT05318
T50MLOC2	CTM6311
T50ML9C2	CTM6312
T50MR0C2	CTM2212
T50MR9C2	CT03317
T50ROC2	CT03316
T50R9C2	CT03317
T50RFT60C2	CT3312M0
T50RSFOC2	CTM3313
T50RTM250HSC2	CTM3314
TELS-SPHSK2	CB12050
TM1SF0C2	CB12150
TWT1	CM11250
TWT2	CM11300
HOBBS	
15570	CB12050
15571	CB12150
15604	CB12050
JEEP	
3841892	BA21200
5461816	BA21200
KENWORTH	
K301-182	TL10400
K301-230	TL10850

Vendor Part No.	Inline Part No.
MACK	
1MR-234	BA21100
1MR3412	TL10550
1MR3412P2	TL10550
1MR3440	TL10550
MIDLAND	
11508	PE20300
B205010	PE20400
BE23101	PE21200
BE23102	PE21100
BE23402	PE24200
BE23403	PE24100
BE23602	PE26200
BE23604	15-630
BE23703	PE27200
BE23784	PE27100
BE27019	PE15200
BE27029	PE12100
BE27031	PE15100
BE27039	PE12200
BE27045	PE12100
BE27046	PE15100
BE27047	PE12200
BE27048	PE15200
BE27070	PE12300
BE27071	PE15300
BE27072	PE15340
MOLEX	
39-00-0078	CN21150
39-01-2120	CN13650
39-01-2165	CN13950
39-01-2185	CN14050
MOTORCRAFT	
SW-257	BA21050

Vendor Part No.	Inline Part No.
SW-259	BA21200
2612CL	PE12100
2612SL	PE12150
2612SM	PE12650
2615CL	PE15100
2615SL	PE15150
2615SM	PE12850
2615SM	PE15650
2617CL2	PE15170
2617CM2	PE15670
2812CL	PE12200
2812CM	PE12700
2815CL	PE15200
2815CM	PE15600
2815CM	PE15700
2912CM	PE12600
NARTRON	
1300-7H	CB12650
NAVISTAR	
1539288	BA21200
116536C91	CN11850
1663595C91	TL10450
370677C91	BA21200
523848C91	TL10450
775863C93	TL10450
PACKARD	
2974678	CN11850
2977047	CN11850
12015509	BL10850
12015840	CN28050
12015864	CN28150
12015865	CN28100
12015866	CN28050
12015870	CN27250
12048277	CN23150
12048278	CN23200

Vendor Part No.	Inline Part No.
12004327	CN12700
12010293	CN50250
12010300	CN50300
12010717	CN11900
12010973	CN11350
12010974	CN12400
12010996	CN10600
12015024	CN12350
12015193	CN50100
12015323	CN50150
12015508	15492518
12015511	CN40450
12015791	CN10500
12015792	CN11100
12015793	CN11750
12015797	CN12250
12015858	CN26650
12015861	CN27550
12015869	CN27300
12020116	CN29850
12020117	CN29750
12020119	CN29400
12020120	CN29350
12020126	CN29150
12020156	CN27900
12020157	CN27950
12020629	CN14000
12020758	CN20250
12020786	CN13350
12020926	CN12600
12033820	CN29250
12033872	CN40200
12033997	CN28000
12034046	CN26800
12034047	CN29900
12034170	CN50500
12040953	CN12900

Vendor Part No.	Inline Part No.
12045696	CN11800
12047767	CN26250
12047948	CN41150
12048074	CN26400
12048086	CN50200
12048087	CN50900
12048159	CN29650
12048254	CN29550
12048369	CN11700
12048371	CN40350
12048443	CN50450
12052172	CN29500
12052217	CN41050
12052219	CN27650
12052221	CN27500
12052222	CN27350
12052224	CN27200
12052466	CN26350
12052634	CN41050
12052641	CN10900
12052643	CN10800
12052644	CN10950
12052825	CN29800
12052826	CN29100
12052827	CN29300
12052832	CN10750
12052845	CN41100
12052850	CN41200
12052978	CN12950
12059168	CN50950
12059897	CN40250
12064971	CN26300
12065862	CN12150
12065863	CN11150
12066195	CN13500
12066214	CN26750
12066269	CN29450

Vendor Part No.	Inline Part No.
12066271	CN29950
12066493	CN29050
12077378	CN14150
12077411	CN26550
12077413	CN26450
12084201	CN26600
12084590	CN27150
12084595	CN27450
12084596	CN27400
12084891	CN12500
12089040	CN25600
12089134	CN20200
12089188	CN24400
12089649	CN20300
12089660	CN20350
12103881	CN26200
12110539	CN12550
12110540	CN40400
12110845	CN26050
12110847	CN26100
12124075	CN26150
12124417	CN23550
12124580	CN24350
12124581	CN24300
12124582	CN25550
12124587	CN25500
12124977	CN29700
12129155	CN11300
12129493	CN26500
12129494	CN26700
12162193	CN10850
12186400	CN12650
15300002	CN11250
15300014	CN40300
15300027	CN11000
2962989	CN21100
2965019	CN12000

Vendor Part No.	Inline Part No.
2965141	CN27850
2965142	CN27800
2965143	CN26950
2965143	CN27750
2965467	CN27100
2965810	CN11600

NORTHEASTERN PLASTICS

20532AA	TL10750
20532AA	602280-777
20532AA	602242-777
20532AA	602200-777
20532AA	602226-777

PETERBILT

16-03827	TL10900
16-04415	TL11050
16-06432	TL10750

PETERSON

570	PE12900
571	PE12800
573	44690
574	PE12950
576	44710
577	PE15940

PHILATRON

2410SL	PE10350
2410SLX	PE10450
2410SLX	PE10950
2410SM	PE10850
2412CL	PE12300
2412CLX	PE12900
2412CM	PE12800
2412SL	PE12350
2412SLX	PE12950
241540CL2	PE15340
241540CL2X	PE15940

Vendor Part No.	Inline Part No.
241540CM2	PE15840
2415CL	PE15300
2415CLX	PE15900
2415CM	PE15800
2415SL	PE15350
2415SLX	PE15950
2415SM	PE15850
2417CL2	PE15370
251540CL2X	PE15440
2610SL	PE10150
2610SM	PE10650

PHILLIPS

15-320	PE21200
15-335	PE21100
15-400	PE24200
15-410	PE24100
15-600	PE26200
15-630	15-630
15-720	PE27200
15-730	PE27100
15-740	PE20400
17-0400	PE20300
17-0401	HE6069
2-101	PB0118BK0
2-102	PB0118BL0
2-104	PB0118GR0
2-105	PB0118R0
2-106	PB0118W0
2-107	PB0118Y0
2-111	PB0116BK0
2-112	PB0116BL0
2-113	PB0116BR0
2-114	PB0116GR0
2-115	PB0116R0
2-116	PB0116W0
2-117	PB0116Y0

Vendor Part No.	Inline Part No.
2-121	PB0114BK0
2-122	PB0114BL0
2-123	PB0114BR0
2-124	PB0114GR0
2-125	PB0114R0
2-126	PB0114W0
2-127	PB0114Y0
2-131	PB0112BK0
2-132	PB0112BL0
2-133	PB0112BR0
2-134	PB0112GR0
2-135	PB0112R0
2-136	PB0112W0
2-137	PE12650
2-141	PB0110BK0
2-142	PB0110BL0
2-143	PE12600
2-144	PB0110GR0
2-145	PB0110R0
2-146	PB0110W0
2-147	PB0110Y0
2-151	PB0108BK0
2-152	PB0108BL0
2-153	PE15200
2-154	PE15700
2-155	PB0108R0
2-156	PB0108W0
22-2031	PE10650
22-2051	PE12650
22-2071	PE15650
22-4320	PE12100
22-4321	PE12600
22-4621	PE15600
22-4721	PE15670
22-9320	PE15100
22-9720	PE15170
24-4320	PE12200

Vendor Part No.	Inline Part No.	Vendor Part No.	Inline Part No.
24-4321	PE12700	27760	HT58050
24-4620	PE15200	80721	VT10060
24-4621	PE15700	81451	VT10100
30-2030	PE10150	81816	VT10250
30-2030	PE10350	82182	VT10310
30-2031	PE10850	82547	VT10380
30-2050	PE12150	82912	VT10500
30-2050	PE12350	88391	VT14060
30-2051	PE12850	88756	VT14100
30-2070	PE15150	89121	VT14250
30-2070	PE15350	89487	VT14380
30-2071	PE15850	89852	VT14310
30-4320	PE12300	90217	VT14080
30-4321	PE12800	95696	VT18060
30-4620	PE15300	96061	VT18100
30-4621	PE15800	96426	VT18250
30-4721	PE15870	96792	VT18080
30-4921	PE15840	97522	VT18310
30-9320	PE12300	107384	PE15940
30-9620	PE15300	131855	VT21180
30-9920	PE15340	132220	VT21140
31-2033	PE10450	132585	VT21100
8037	HT14080	133316	CD32400
8402	HT14100	136968	VT54050
8767	HT14250	137333	VT54000
9133	HT14310	139160	VT66070
9498	HT14380	139525	VT66060
11689	VT10500	139890	VT66060
12055	HT10100	140255	VT66070
12420	HT10250	189928	BA23300
13150	HT10380	190659	VT30100
22282	HT21180	194311	CD32400
22647	HT21140	194677	VT34060
23012	HT21100	31-2033	PE10950
25934	HT54000	31-2053	PE12950
26299	HT54050	31-2073	PE15950
27395	HT58000	31-9323	PE12900

Vendor Part No.	Inline Part No.
31-9623	PE15900
31-9923	PE15440
31-9923	PE15940
53-115	CC22150
53-120	CC22200
53-130	CC22300
54-140	CD32400

POLLAK

24-359P	BA28850
24-360P	BA28900
31-109	BA23100
31-110P	BA23150
31-192P	BA23200
31-359P	BA23250
31-403P	BA23300
51-302P	BA22200
52-307	CD32400

SIEMENS

12088519	CB12200
VF415F11S01	CB12800
VF7-11F11S01	CB12750
VFMA15F41S01	CB12250

SIGNAL STAT

242	44690
262	PE10850
263	PE10350
282	44710
283	PE12300
900	TL10350
902	TL10300
905	TL10800
910	TL10350
900Y114	TL10450
900Y129	TL10500
900Y170	TL10600

Vendor Part No.	Inline Part No.
900Y206	TL10450
900Y73	TL10550

SLOAN

421007	PE12100
421010	PE12200
421113	PE15200
421115	PE15100
421129	PE12300
421130	PE15300

SUREFLEX

SF10SE	PE10150
SF10SE	PE10650
SF125CE	PE12100
SF12SE	PE12150
SF12SE	PE12650
SF155CE	PE15100
SF15SE	PE15150
SF15SE	PE15650
SFA10SE	PE10850
SFA10SEN	PE10350
SFA125CE	PE12800
SFA125CEN	PE12300
SFA12SE	PE12850
SFA12SEN	PE12350
SFA155CE	PE15800
SFA155CE40	PE15840
SFA155CE40N	PE15340
SFA155CEN	PE15300
SFA15SE	PE15850
SFA15SEN	PE15350
SFI10SE	PE10450
SFI10SE	PE10950
SFI125CE	PE12900
SFI12SE	PE12950
SFI155CE	PE15900
SFI155CE40	PE15440

Vendor Part No.	Inline Part No.
SFI155CE40	PE15940
SFI15SE	PE15950
SF0122CE	PE12200
SF0125CE	PE12600
SF012SE	PE12700
SF0155CE	PE15200
SF0155CE	PE15600
SF015SE	PE15700

TECHTRAN

9400	PE20300
670-11	PE21100
670-12	PE21200
670-41	PE24100
670-42	PE24200
670-61	15-630
670-62	PE26200
670-71SG	PE27100
670-72	PE27200
670-722	PE20400
7A3B122EG	PE12950
7A3B12EG	PE15950
7AAB102MG	PE10350
7AAB102MG	PE10850
7AAB122MG	PE12350
7AAB122MG	PE12850
7AAB152MG	PE15350
7AAB152MG	PE15850
7AEB102EG	PE10450
7AEB102EG	PE10950
7ATG222EG	PE12900
7ATG222MG	PE12300
7ATG222MG	PE12800
7ATG522EG	PE15900
7ATG522MG	PE15300
7ATG522MG	PE15800
7ATG542EG	PE15940
7ATG542MG	PE15340
7ATG542MG	PE15840

Vendor Part No.	Inline Part No.
7ATG543EG	PE15440
7EAB122MG	PE12700
7EAB122MG	PE15700
7ETB522MG	PE15600
7MTY222MG	PE12200
7MTY522MG	PE12600
7MTY522MG	PE15200
7SAB102MG	PE21100
7SAB112MG	PE12650
7SAB122MG	PE10650
7SAB122MG	PE12150
7SAB152MG	PE15150
7SAB152MG	PE15650
7STS222MG	PE12100
7STS522MG	PE15100

TEXAS INSTRUMENTS

CDM10	PE20400
CDM15	CC33150
CDM20	CC33200
CDM25	CC33250
CDM30	CC33300
CDM35	CC33350
CDM40	CC33400
NDLA105-1	CC31050
NDLA120-1	CC31200
NDLA135-1	CC31350
NDLA150-1	CC31500
NDLA35-1	CC30350
NDLA40-1	CC30400
NDLA45-1	CC30450
NDLA50-1	CC30500
NDLA60-1	CC30600
NDLA70-1	CC30700
NDLA80-1	CC30800
NDLA90-1	CC30900

Vendor Part No.	Inline Part No.
TRAMEC	
34200	PE20300
34260	HE6069
38181	PE21100
38194	PE24100
38195	15-630
38197	PE27100
38491	PE21200
38494	PE24200
38496	PE26200
38497	PE27200
3849709	PE20400
29604-12	PE12900
38604-15	PE15900
45A12	PE12100
45A15	PE15100
45A16	PE15670
46A10	PE10150
46A12	PE10650
46A12	PE12150
46A12	PE12650
46A15	PE15150
46A15	PE15650
47A12	PE12200
47A12	PE12600
47A15	PE15200
47A15	PE15600
48A12	PE12700
48A15	PE15700
4AA12	PE12300
4AA12	PE12800
4AA15	PE15300
4AA15	PE15800
4AA16	PE15870
4AA17	PE15340
4AA17	PE15840
4BA10	PE10350
4BA10	PE10850

Vendor Part No.	Inline Part No.
4BA12	PE12350
4BA12	PE12850
4BA15	PE15350
4BA15	PE15850
TRUCK-LITE	
50820	PE15350
97205	44690
97206	PE15150
97207	44710
97208	PE12900
97210	PE15900
97211	PE15440
UNITED TECHNOLOGIES	
361030YF200	CN22650
361130YF200	CN22700
361430YF200	CN22600
361830YF200	CN22550
362230YF200	TL10950
771016FK200	CN22900
771116FK200	CN22950
771316FK200	CN23000
771416FK200	CN22800
771816FK200	CN22850
VELVAC	
590046	PE10650
590046	PE12150
590046	PE12650
590154	PE12100
590155	PE15100
590156	PE12200
590156	PE12600
590157	PE15200
590157	PE15600
590159	PE15670
590160	PE12300
590160	PE12800

Vendor Part No.	Inline Part No.
590161	PE15300
590161	PE15800
590163	PE15340
590163	PE15840
590165	PE12350
590165	PE12850
590166	PE15350
590166	PE15850
590178	PE15150
590178	PE15650
590251	PE12900
590252	PE15900
590253	PE15440
590253	PE15940
590255	PE12950
590256	PE15950

VOLVO/WHITE

84401-0005	TL10500
84401-3203	TL10950

WHITAKER

412026	CN20900
--------	---------

NOTES

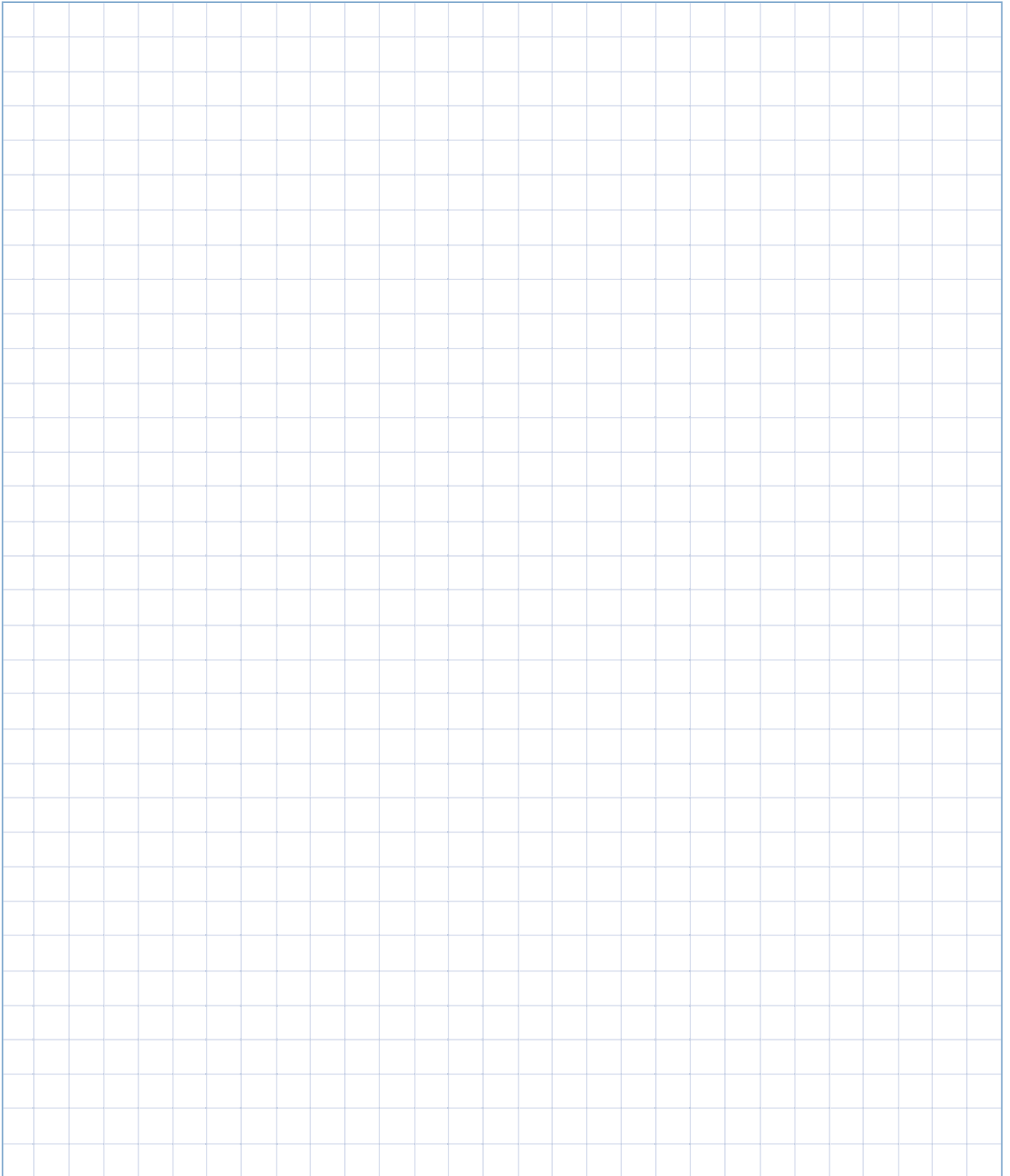

ELECTRICAL

NOTES

A large rectangular area filled with a light blue grid pattern, intended for writing notes. The grid consists of small squares and covers most of the page's content area.

NOTES

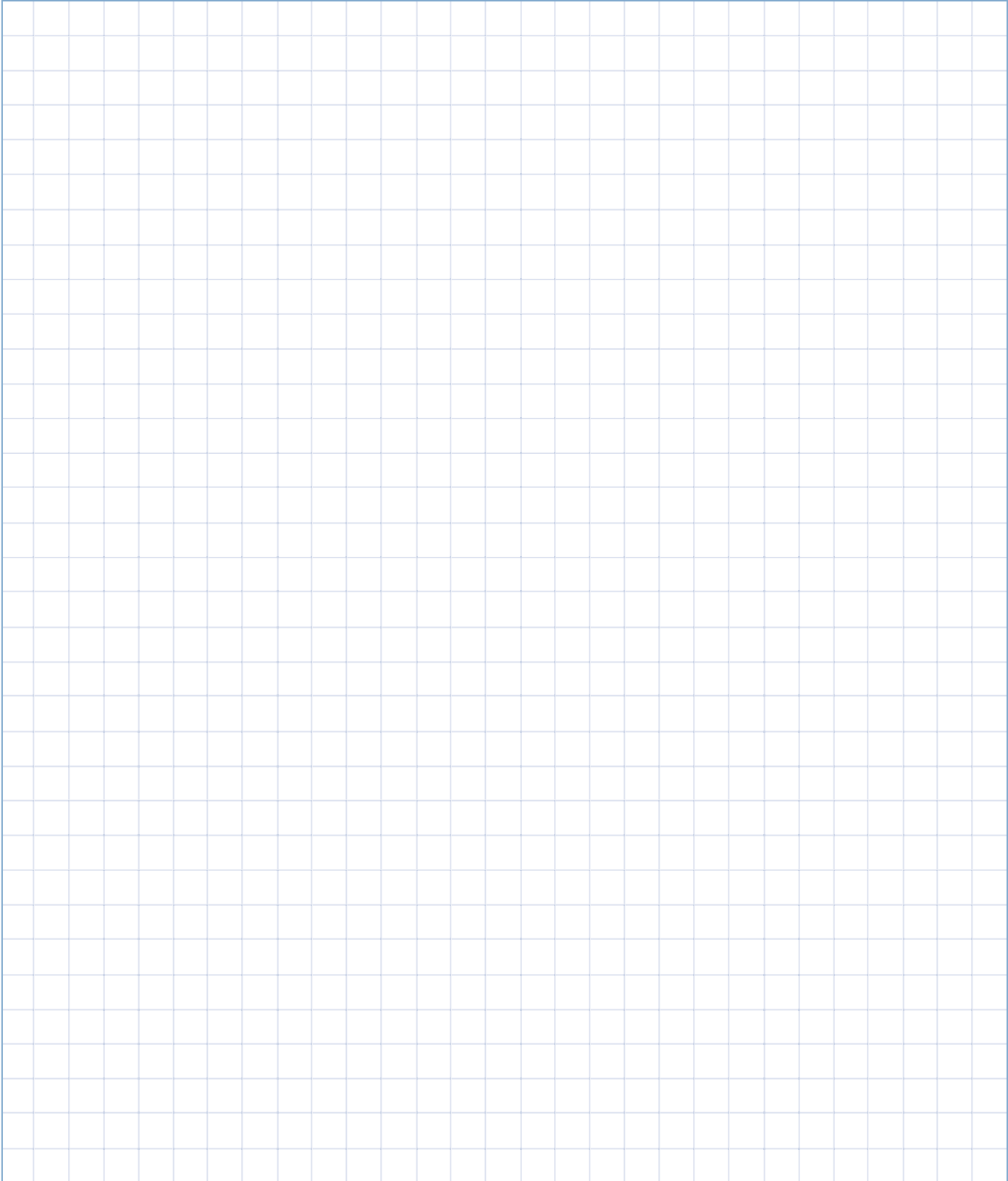

ELECTRICAL



*For information, updates, or corrections,
please contact us at feedback@TRPParts.com*

*No part of this marketing material may be
reproduced in any manner without written
permission from TRP® North America.*

**TRP100EN-A
06/14/2012**

TRP® North America

750 Houser Way N.
Renton, WA 98057

www.TRPParts.com